

4-line ESD protection for high speed lines

Datasheet - production data

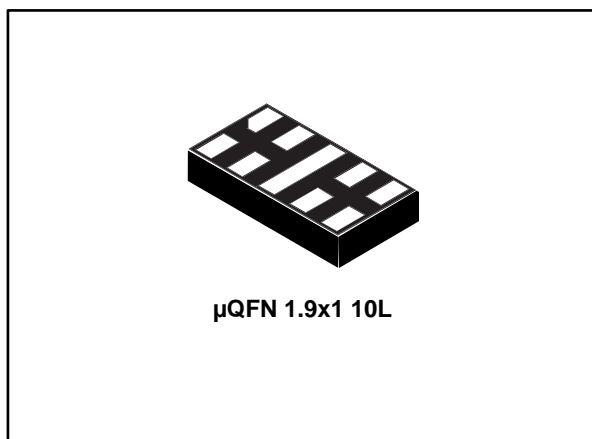

Features

- Flow-through routing to keep signal integrity
- Ultralarge bandwidth: 10 GHz
- Ultralow capacitance:
 - 0.2 pF (I/O to I/O)
 - 0.35 pF (I/O to GND)
- Very low dynamic resistance: 0.48 Ω
- 100 Ω differential impedance
- Low leakage current: 100 nA at 25 °C
- Extended operating junction temperature range: -40 °C to 150 °C
- RoHS compliant

Benefits

- High ESD protection level
- High integration
- Suitable for high density boards

Complies with the following standards

- MIL STD 883G-Method 3015-7: class 3B
 - 8 kV
- IEC 61000-4-2, level 4
 - 25 kV (air discharge)
 - 8 kV (contact discharge)

Applications

The HSP051-4N10 is designed to protect against electrostatic discharge on sub micron technology circuits driving:

- HDMI 1.4 and 2.0
- Digital video Interface
- Display port
- USB 3.0 and 3.1
- Serial ATA

Description

The HSP051-4N10 is a 4-channel ESD array with a rail to rail architecture designed specifically for the protection of high speed differential lines.

The ultralow variation of the capacitance ensures very low influence on signal-skew. The large bandwidth makes it compatible with HDMI 2.0 4K/2K (= 5.94 Gbps) and USB 3.1 (= 10 Gbps)

The device is packaged in μQFN 1.9 mm x 1 mm with a 400 μm pitch.

Figure 1: Functional schematic (top view)

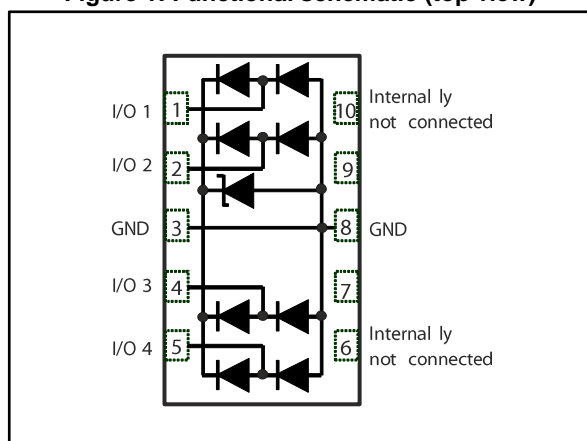

1 Characteristics

Table 1: Absolute maximum ratings ($T_{amb} = 25\text{ }^{\circ}\text{C}$)

Symbol	Parameter		Value	Unit
V_{pp}	Peak pulse voltage	IEC61000-4-2 contact discharge	8	kV
		IEC61000-4-2 air discharge	25	
T_{stg}	Storage junction temperature range		-65 to +150	$^{\circ}\text{C}$
T_j	Operating junction temperature range		-40 to +150	
T_L	Maximum lead temperature for soldering during 10 s		260	

Table 2: Electrical characteristics ($T_{amb} = 25\text{ }^{\circ}\text{C}$)

Symbol	Parameter	Test condition	Min.	Typ.	Max.	Unit
V_{BR}	$I_R = 1\text{ mA}$		4.5	5.8		V
I_{RM}	$V_{RM} = 3.6\text{ V}$			10	100	nA
V_{CL}	$I_{PP} = 1\text{ A}$, 8/20 μs				10	V
V_{CL}	IEC 61000-4-2, +8 kV contact ($I_{PP} = 16\text{ A}$), measured at 30 ns			13		V
R_d	Dynamic resistance, pulse duration 100 ns	I/O to GND		0.48		Ω
		GND to I/O		0.96		
$C_{I/O - I/O}$	$V_{I/O} = 0\text{ V}$	$F = 200\text{ MHz to }9\text{ GHz}$		0.2	0.3	pF
$C_{I/O - GND}$	$V_{I/O} = 0\text{ V}$	$F = 200\text{ MHz to }2.5\text{ GHz}$		0.4	0.55	pF
		$F = 2.5\text{ GHz to }9\text{ GHz}$		0.35	0.45	pF
f_c	-3 dB			10		GHz
Z_{diff}	Time domain reflectometry: $t_r = 200\text{ ps}$ (10 - 90%), $Z_0 = 100\ \Omega$		85	100	115	Ω

1.1 Characteristics (curves)

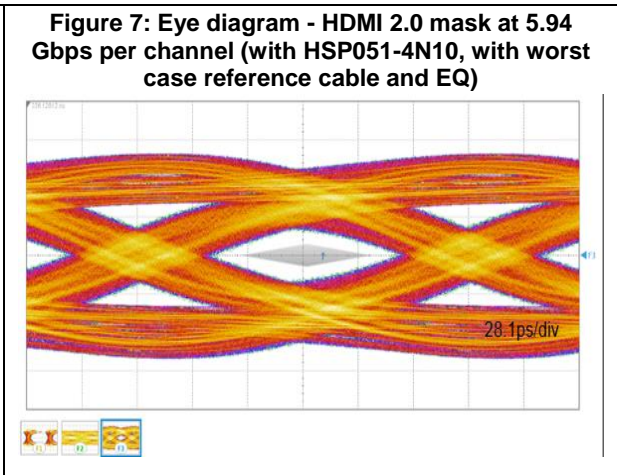
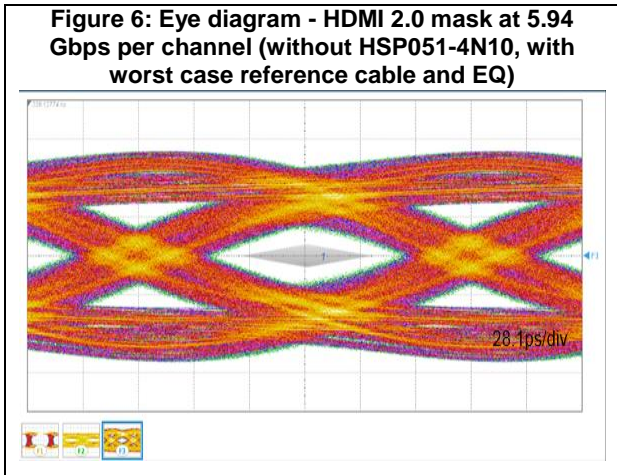
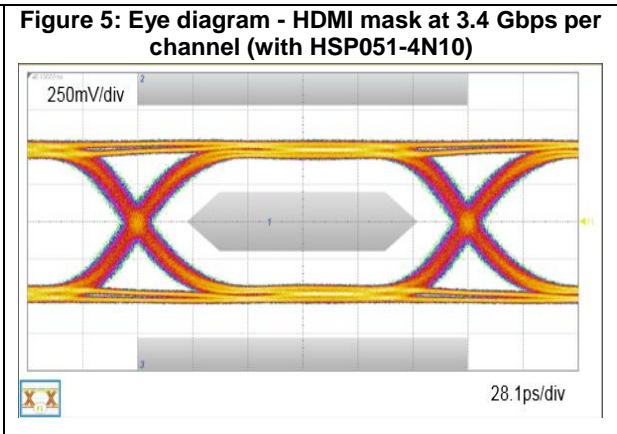
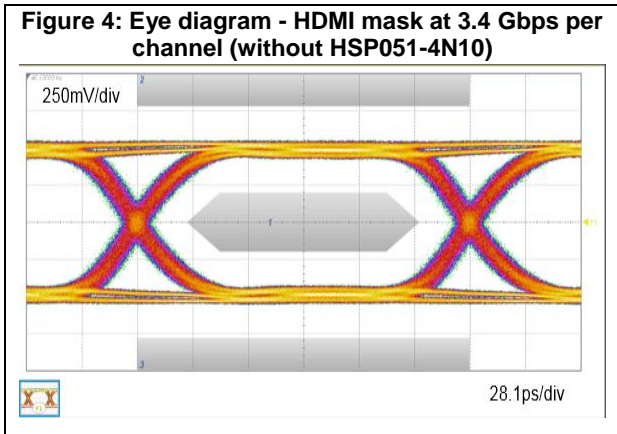
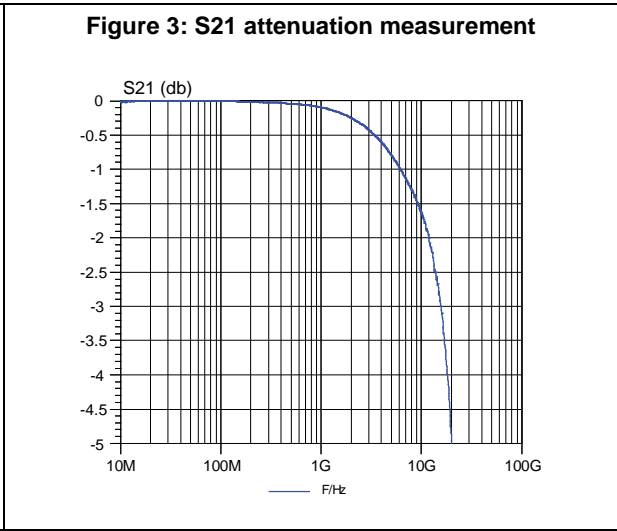
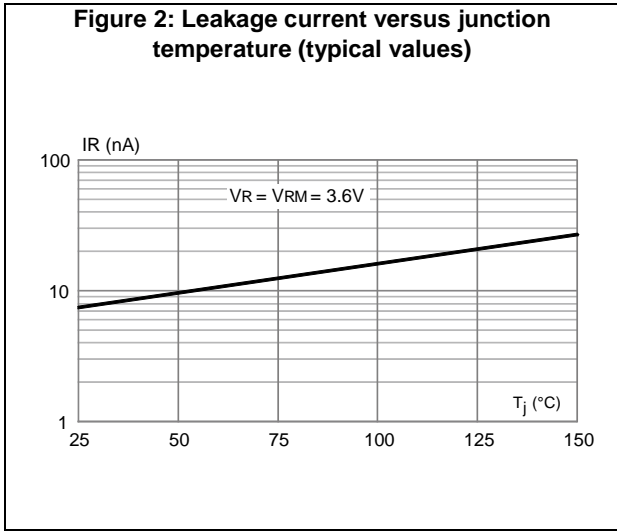

Figure 8: Eye diagram - USB 3.0 gen. 1 (5.0 Gbps) without HSP051-4N10 (with reference cable and equalizer)

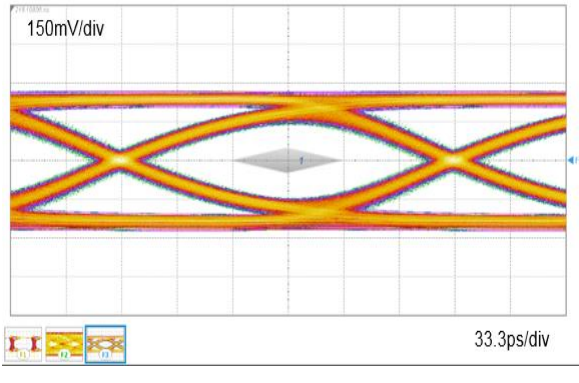

Figure 9: Eye diagram - USB 3.0 gen. 1 (5.0 Gbps) with HSP051-4N10 (with reference cable and equalizer)

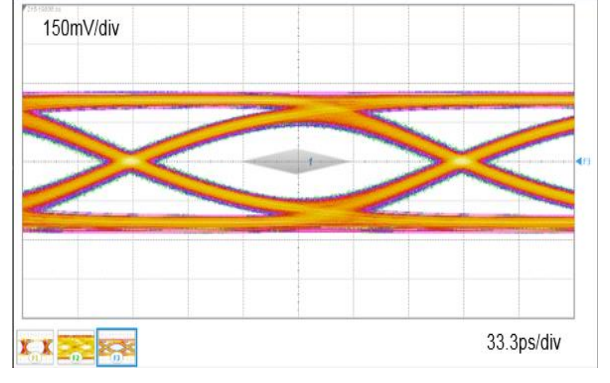

Figure 10: Eye diagram - USB 3.1 gen.2 (10.0 Gbps) without HSP051-4N10 (with reference cable, equalizer A = 6 dB and DFE)

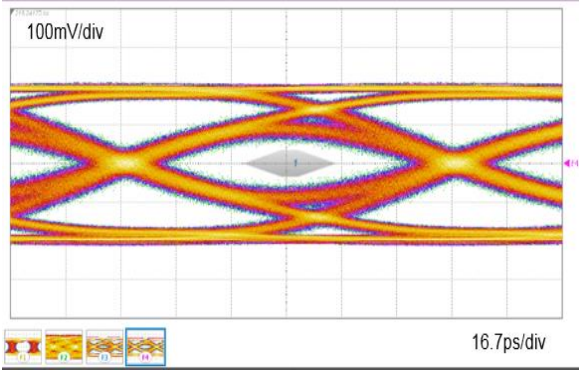

Figure 11: Eye diagram - USB 3.1 gen.2 (10.0 Gbps) with HSP051-4N10 (with reference cable, equalizer A = 6 dB and DFE)

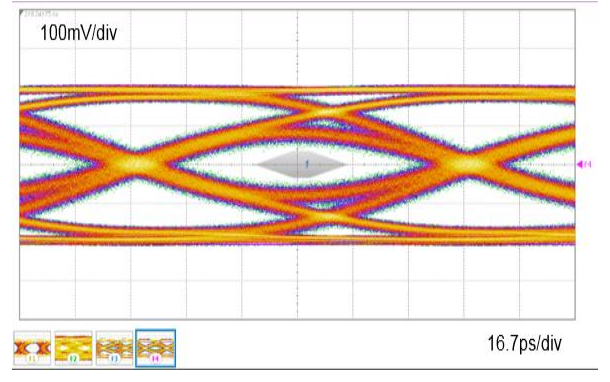

Figure 12: ESD response to IEC 61000-4-2 (+8 kV contact discharge)

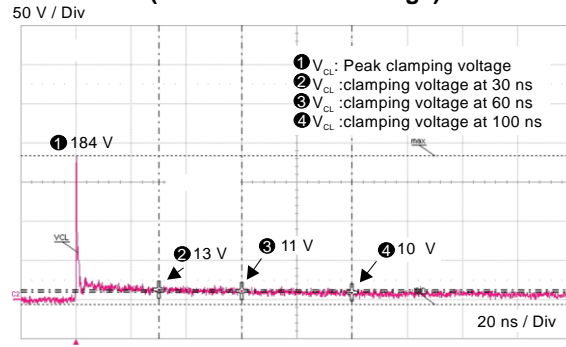

Figure 13: ESD response to IEC 61000-4-2 (-8 kV contact discharge)

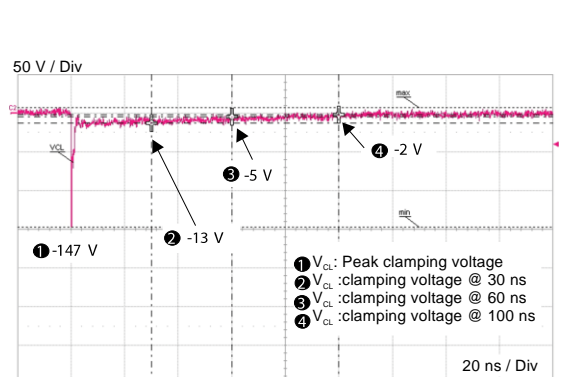

Figure 14: TLP measurement (pulse duration 100 ns, rise time 10 ns, average window 70 ns 90ns)

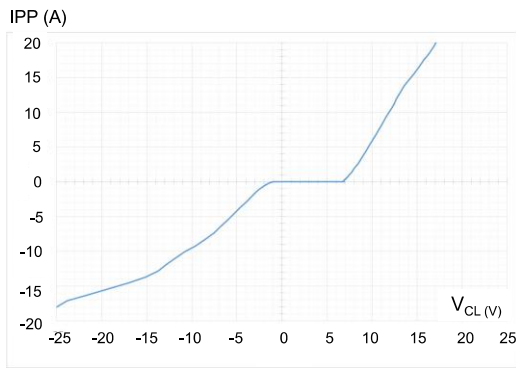

Figure 15: TDR measurement



2 Package information

In order to meet environmental requirements, ST offers these devices in different grades of ECOPACK® packages, depending on their level of environmental compliance. ECOPACK® specifications, grade definitions and product status are available at: www.st.com. ECOPACK® is an ST trademark.

2.1 μQFN1.9x1 10L package information

Figure 16: μQFN1.9x1 10L package outline

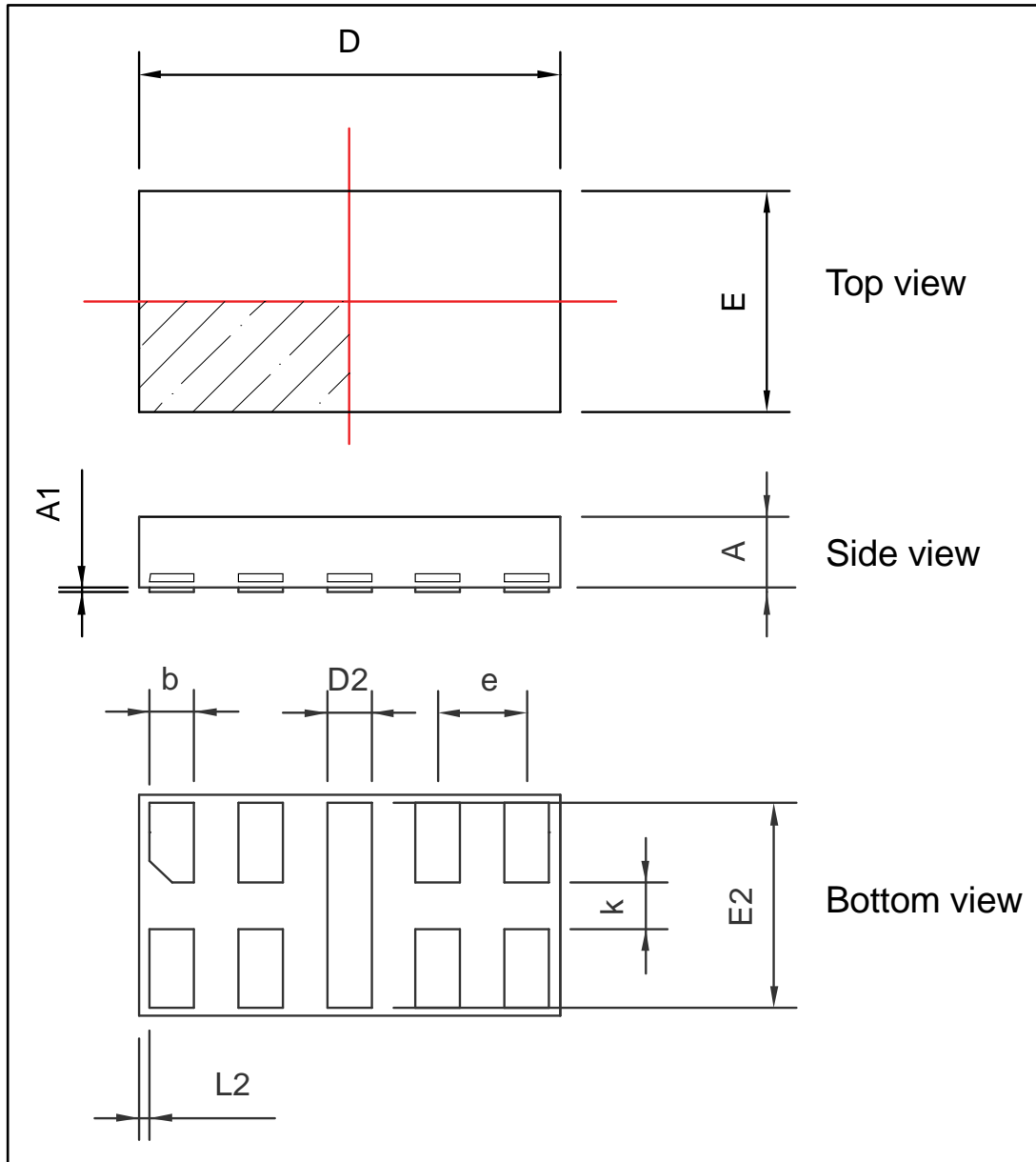
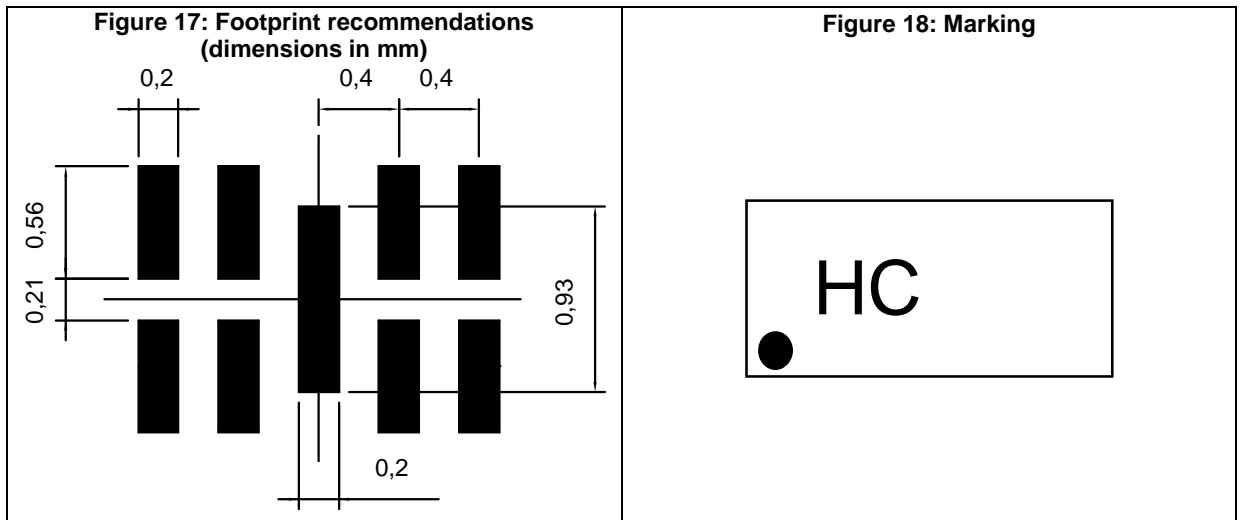

Table 3: μ QFN1.9x1 10L package mechanical data

Ref.	Dimensions		
	Millimeters		
	Min.	Typ.	Max.
A	0.28	0.32	0.35
A1	0.00	0.02	0.05
b	0.15	0.20	0.25
D	1.85	1.90	1.95
D2	0.15	0.20	0.25
E	0.95	1.00	1.05
E2	0.88	0.93	0.98
e		0.40	
k		0.21	
L2	0.02	0.05	0.07



the marking codes can be rotated by 180° to differentiate assembly location. In no case should this product marking be used to orient the component for placement on a PCB. Only pin 1 mark is to be used for this purpose.

Figure 19: μ QFN1.9x1 10L tape and reel specification

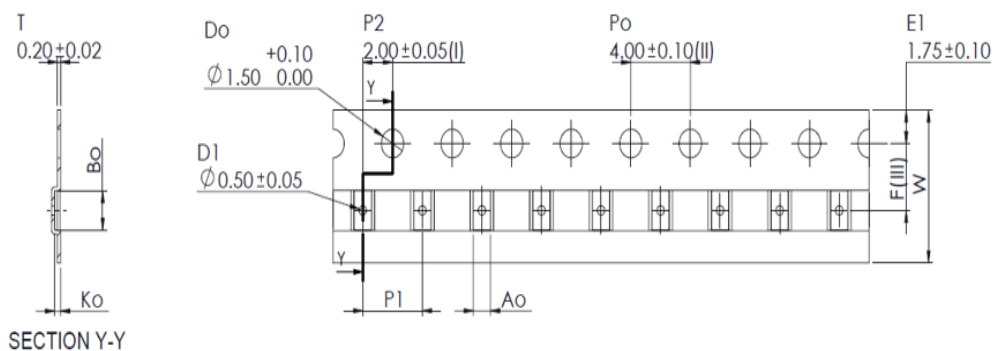

Ao	1.15 +/- 0.05
Bo	2.05 +/- 0.05
Ko	0.40 +/- 0.05
F	3.50 +/- 0.05
P1	4.00 +/- 0.10
W	8.00 +/- 0.10

3 Recommendation on PCB assembly

Figure 20: Recommended stencil window position

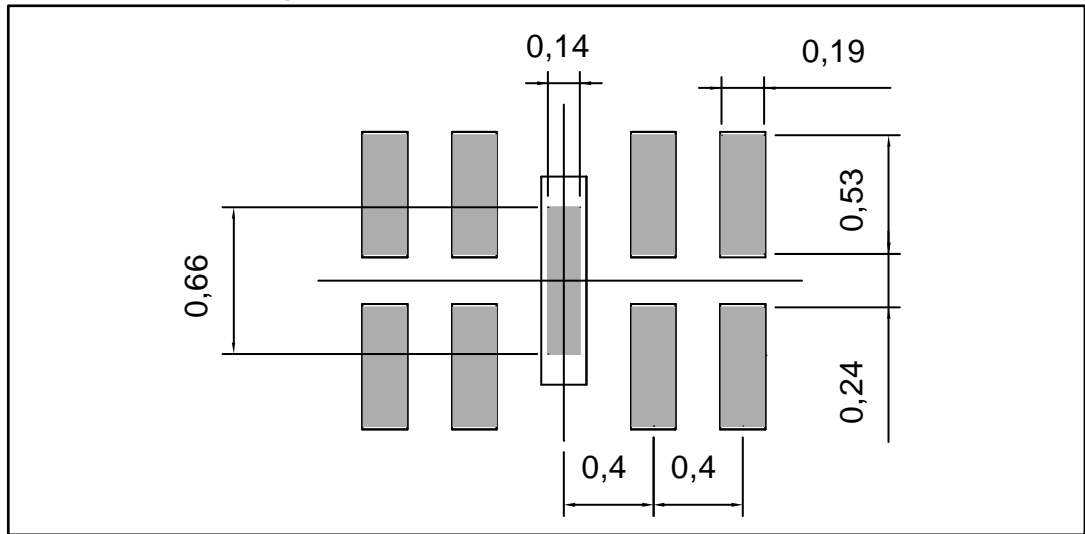

3.1 Solder paste

1. Halide-free flux qualification ROL0 according to ANSI/J-STD-004.
2. "No clean" solder paste is recommended.
3. Offers a high tack force to resist component movement during high speed.
4. Solder paste with fine particles: powder particle size is 20-45 μm .

3.2 Placement

1. Manual positioning is not recommended.
2. It is recommended to use the lead recognition capabilities of the placement system, not the outline centering
3. Standard tolerance of ± 0.05 mm is recommended.
4. 3.5 N placement force is recommended. Too much placement force can lead to squeezed out solder paste and cause solder joints to short. Too low placement force can lead to insufficient contact between package and solder paste that could cause open solder joints or badly centered packages.
5. To improve the package placement accuracy, a bottom side optical control should be performed with a high resolution tool.
6. For assembly, a perfect supporting of the PCB (all the more on flexible PCB) is recommended during solder paste printing, pick and place and reflow soldering by using optimized tools.

3.3 PCB design preference

1. To control the solder paste amount, the closed via is recommended instead of open vias.
2. The position of tracks and open vias in the solder area should be well balanced. The symmetrical layout is recommended, in case any tilt phenomena caused by asymmetrical solder paste amount due to the solder flow away.

Figure 21: Printed circuit board layout recommendations

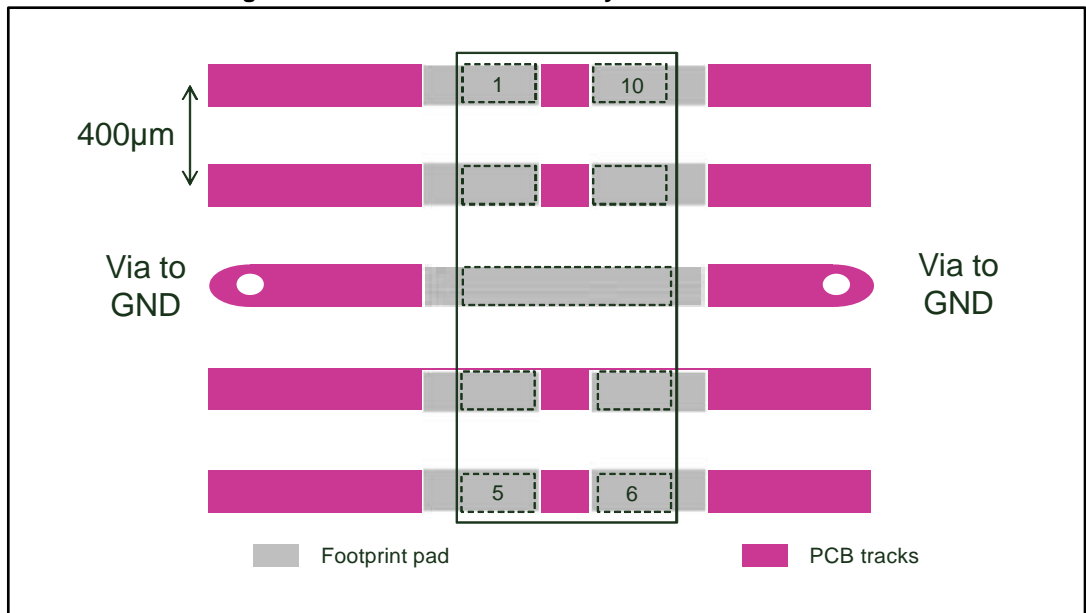

3.4 Reflow profile

Figure 22: ST ECOPACK® recommended soldering reflow profile for PCB mounting

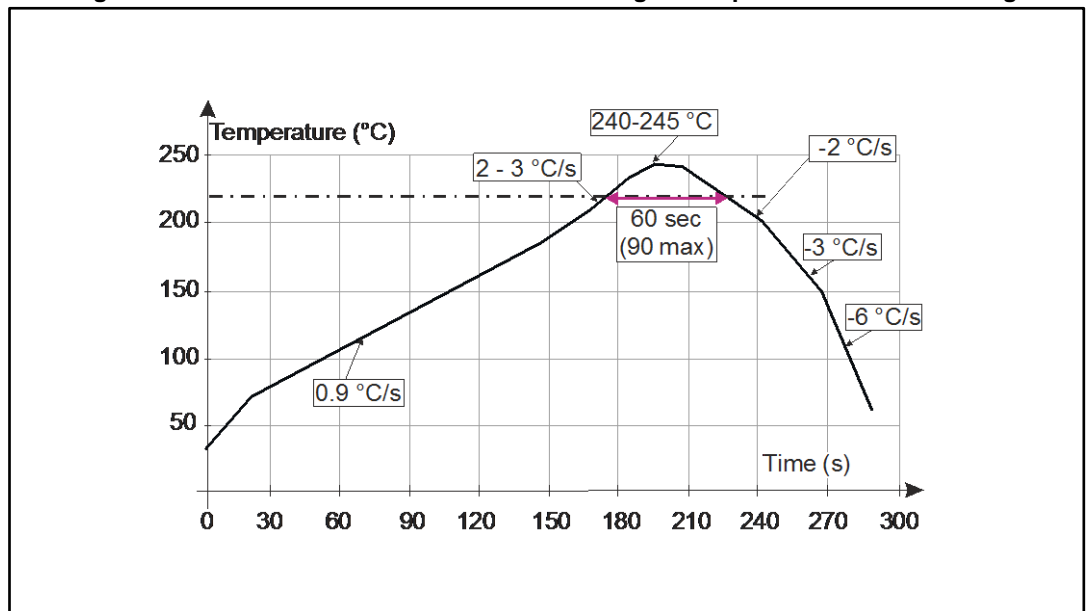

Minimize air convection currents in the reflow oven to avoid component movement. Maximum soldering profile corresponds to the latest IPC/JEDEC J-STD-020.

4 Ordering information

Figure 23: Ordering information scheme

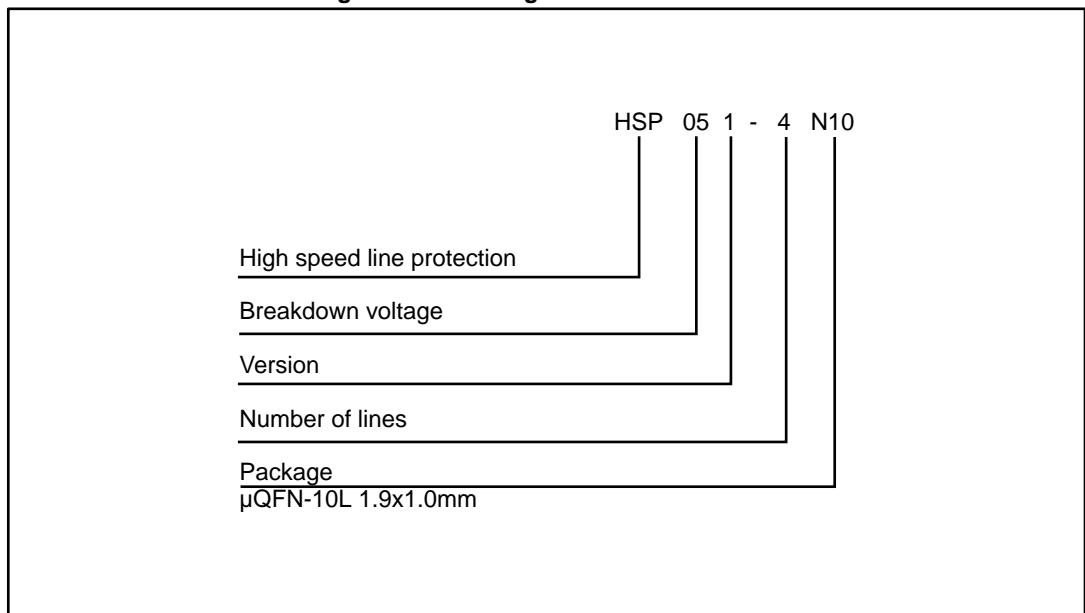

Table 4: Ordering information

Order code	Marking	Package	Weight	Base qty.	Delivery mode
HSP051-4N10	HC	μ QFN-10L	1.61 mg	7000	Tape and reel

5 Revision history

Table 5: Document revision history

Date	Revision	Changes
11-Jul-2014	1	Initial release.
19-May-2017	2	Updated Figure 16: "μQFN1.9x1 10L package outline" and Figure 19: "μQFN1.9x1 10L tape and reel specification" .

IMPORTANT NOTICE – PLEASE READ CAREFULLY

STMicroelectronics NV and its subsidiaries ("ST") reserve the right to make changes, corrections, enhancements, modifications, and improvements to ST products and/or to this document at any time without notice. Purchasers should obtain the latest relevant information on ST products before placing orders. ST products are sold pursuant to ST's terms and conditions of sale in place at the time of order acknowledgement.

Purchasers are solely responsible for the choice, selection, and use of ST products and ST assumes no liability for application assistance or the design of Purchasers' products.

No license, express or implied, to any intellectual property right is granted by ST herein.

Resale of ST products with provisions different from the information set forth herein shall void any warranty granted by ST for such product.

ST and the ST logo are trademarks of ST. All other product or service names are the property of their respective owners.

Information in this document supersedes and replaces information previously supplied in any prior versions of this document.

© 2017 STMicroelectronics – All rights reserved

X-ON Electronics

Largest Supplier of Electrical and Electronic Components

Click to view similar products for [ESD Suppressors / TVS Diodes](#) category:

Click to view products by [STMicroelectronics](#) manufacturer:

Other Similar products are found below :

[60KS200C](#) [D12V0H1U2WS-7](#) [D18V0L1B2LP-7B](#) [82356050220](#) [D5V0M5U6V-7](#) [NTE4902](#) [P4KE27CA](#) [P6KE11CA](#) [P6KE39CA-TP](#)
[P6KE8.2A](#) [SA110CA](#) [SA60CA](#) [SA64CA](#) [SMBJ12CATR](#) [SMBJ8.0A](#) [SMLJ30CA-TP](#) [ESD101-B1-02ELS E6327](#) [ESD112-B1-02EL E6327](#)
[ESD119B1W01005E6327XTSA1](#) [ESD5V0J4-TP](#) [ESD5V0L1B02VH6327XTSA1](#) [ESD7451N2T5G](#) [19180-510](#) [CPDT-5V0USP-HF](#)
[3.0SMCJ33CA-F](#) [3.0SMCJ36A-F](#) [HSPC16701B02TP](#) [D3V3Q1B2DLP3-7](#) [D55V0M1B2WS-7](#) [DESD5V0U1BL-7B](#) [DRTR5V0U4SL-7](#)
[SCM1293A-04SO](#) [ESD200-B1-CSP0201 E6327](#) [ESD203-B1-02EL E6327](#) [SM12-7](#) [SMF8.0A-TP](#) [SMLJ45CA-TP](#) [CEN955 W/DATA](#)
[82350120560](#) [82356240030](#) [VESD12A1A-HD1-GS08](#) [CPDUR5V0R-HF](#) [CPDUR24V-HF](#) [CPDQC5V0U-HF](#) [CPDQC5V0USP-HF](#)
[CPDQC5V0-HF](#) [D1213A-01LP4-7B](#) [D1213A-02WL-7](#) [ESDLIN1524BJ-HQ](#) [5KP100A](#)