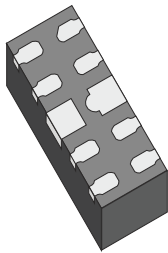
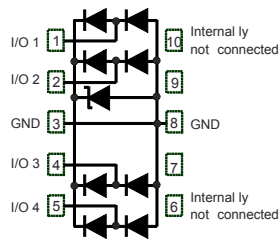


## 4-line ESD protection for high speed lines



μQFN-10L package

Functional schematic (top view)



### Product status

HSP061-4M10

### Features

- Flow-through routing to keep signal integrity
- Ultralarge bandwidth: 8.7 GHz
- Ultralow capacitance: 0.3 pF
- Very Low dynamic resistance: 0.48 Ω
- Low leakage current: 70 nA at 25 °C
- 100 Ω differential impedance
- Extended operating junction temperature range: -40 °C to 150 °C
- Thin package: 0.5 mm max.
- RoHS compliant
- High ESD robustness of the equipment
- Suitable for high density boards
- Complies with following standards:
  - MIL-STD 883G Method 3015-7 Class 3B: – 8 kV
  - IEC 61000-4-2 level 4: 8 kV (contact discharge), 15 kV (air discharge)

### Applications

The HSP061-4M10 is designed to protect against electrostatic discharge on sub micron technology circuits driving:

- HDMI 1.3 and 1.4
- USB3.0
- Digital Video Interface
- Display Port
- Serial ATA
- Thunderbolt

### Description

The HSP061-4M10 is a 4-channel ESD array with a rail to rail architecture designed specifically for the protection of high speed differential lines.

The ultralow variation of the capacitance ensures very low influence on signal-skew. The large bandwidth make the device compatible with 3.4 Gbps.

The device is packaged in μQFN 2.5 mm x 1 mm with a 500 μm pitch, which minimizes the PCB area.

# 1 Characteristics

**Table 1. Absolute maximum ratings  $T_{amb} = 25\text{ }^{\circ}\text{C}$** 

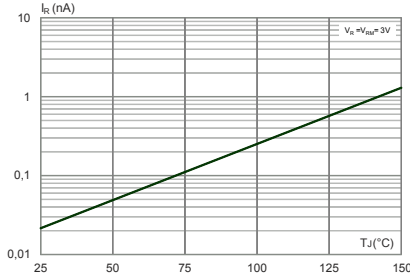
Symbol	Parameter		Value	Unit
$V_{PP}$	Peak pulse voltage	IEC 61000-4-2 contact discharge	8	kV
		IEC 61000-4-2 air discharge	20	
$T_j$	Operating junction temperature range		-40 to +150	$^{\circ}\text{C}$
$T_{stg}$	Storage temperature range		-65 to +150	$^{\circ}\text{C}$
$T_L$	Maximum lead temperature for soldering during 10 s		260	$^{\circ}\text{C}$

**Table 2. Electrical characteristics  $T_{amb} = 25\text{ }^{\circ}\text{C}$** 

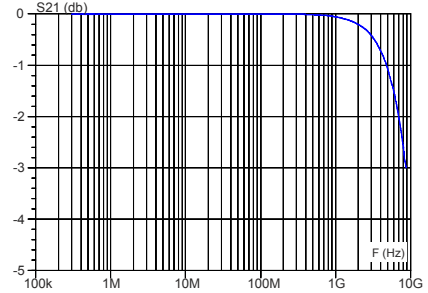
Symbol	Parameter	Value			Unit
		Min.	Typ.	Max.	
$V_{BR}$	$I_R = 1\text{ mA}$	6.0			V
$I_{RM}$	$V_{RM} = 3.0\text{ V}$			70	nA
$V_{CL}$	$I_{PP} = 1\text{ A}, 8/20\text{ }\mu\text{s}$			15	V
CI/O - I/O	$V_{I/O} = 0\text{ V}, F = 1\text{ MHz}, V_{OSC} = 30\text{ mV}$		0.3	0.4	pF
CI/O - GND	$V_{I/O} = 0\text{ V}, F = 1\text{ MHz}, V_{OSC} = 30\text{ mV}$		0.6	0.8	pF
$f_C$	-3dB		8.7		GHz
$Z_{diff}$	Time domain reflectometry: $t_r = 200\text{ ps}$ (10 - 90%), $Z_{0\text{ DIFF}} = 100\text{ }\Omega$	85	100	115	$\Omega$

## 1.1 On-board measurements

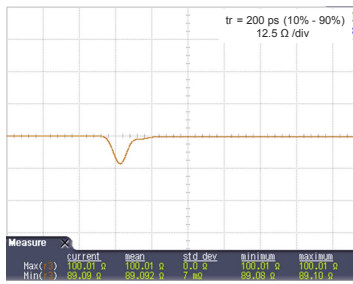
**Figure 1. Leakage current versus junction temperature (typical values)**



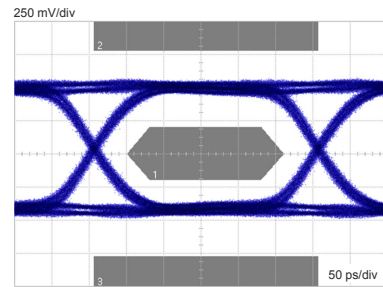
**Figure 2. S21 attenuation measurement**



**Figure 3. Differential impedance (Zdiff)**

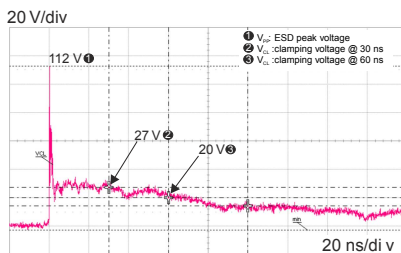


**Figure 5. Eye diagram - HDMI mask at 3.4 Gbps per channel**

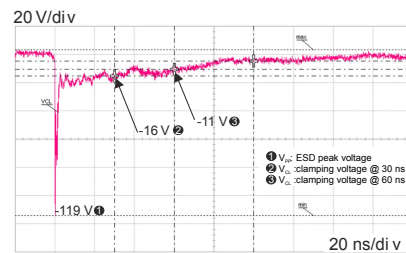


1. HDMI specification conditions. This information can be provided for other applications. Please contact your local ST office.

**Figure 7. ESD response to IEC 61000-4-2 (+8 kV contact discharge)**



**Figure 8. ESD response to IEC 61000-4-2 (-8 kV contact discharge)**



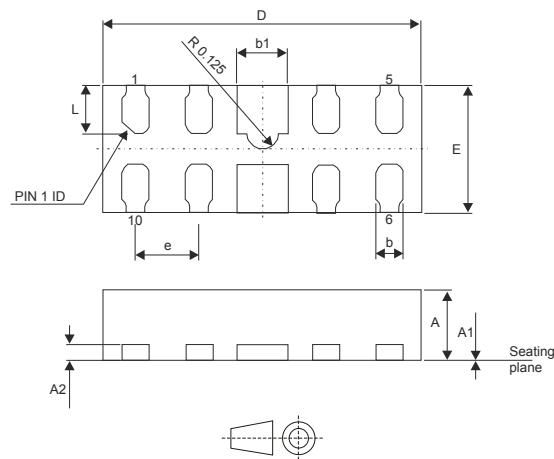
## 2 Package information

In order to meet environmental requirements, ST offers these devices in different grades of ECOPACK® packages, depending on their level of environmental compliance. ECOPACK® specifications, grade definitions and product status are available at: [www.st.com](http://www.st.com). ECOPACK® is an ST trademark.

### 2.1 μQFN-10L dimension values

- Epoxy meets UL94, V0
- Lead-free package

**Figure 9. μQFN-10L dimension definitions**



**Table 3. μQFN-10L dimension values**

Ref.	Dimensions					
	Millimeters			Inches		
	Min.	Typ.	Max.	Min.	Typ.	Max.
A	0.40	0.47	0.50	0.018	0.018	0.020
A1	0.00	0.00	0.05	0.00	0.000	0.002
A2		0.13			0.005	
b	0.15	0.20	0.25	0.006	0.008	0.009
b1	0.35	0.40	0.45	0.014	0.016	0.041
D	2.40	2.50	2.60	0.094	0.098	0.102
E	0.90	1.00	1.10	0.035	0.039	0.043
e		0.50			0.206	
L	0.33	0.38	0.43	0.012	0.015	0.017
aaa		0.08			0.003	
bbb		0.10			0.004	

Figure 10. Footprint recommendations (dimensions in mm)

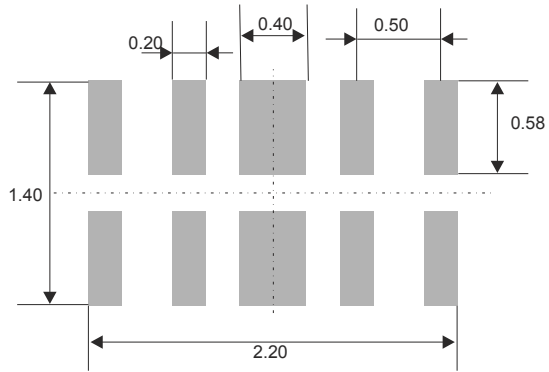


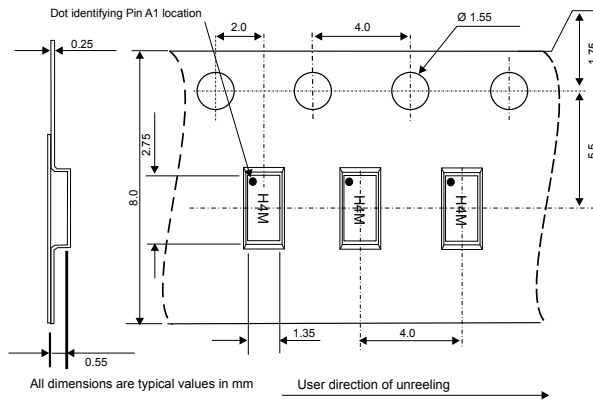
Figure 11. Marking



Note:

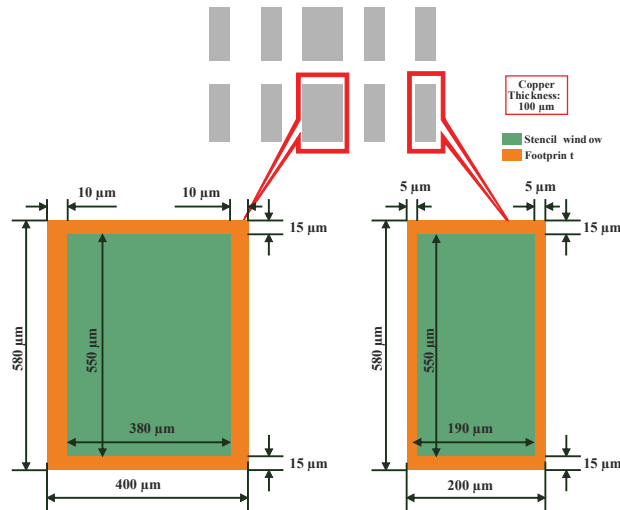
Product marking may be rotated by 180° for assembly plant differentiation. In no case should this product marking be used to orient the component for its placement on a PCB. Only pin 1 mark is to be used for this purpose.

Figure 12.  $\mu$ QFN-10L tape and reel specification



### 3 Recommendation on PCB assembly

**Figure 13.  $\mu$ QFN-10L dimension definitions**



#### 3.1 Solder paste

1. Halide-free flux qualification ROL0 according to ANSI/J-STD-004.
2. "No clean" solder paste is recommended.
3. Offers a high tack force to resist component movement during high speed.
4. Solder paste with fine particles: powder particle size is 20-45  $\mu\text{m}$ .

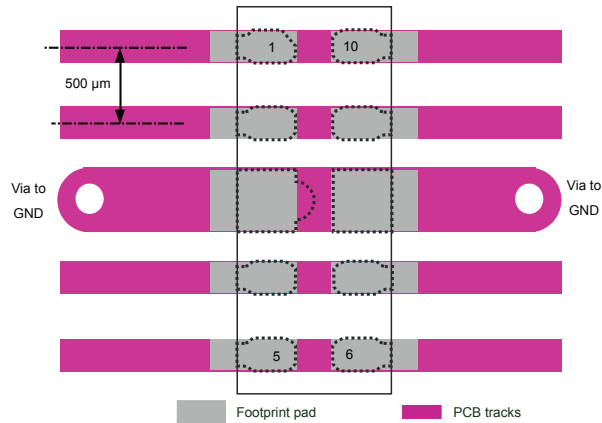
#### 3.2 Placement

1. Manual positioning is not recommended.
2. It is recommended to use the lead recognition capabilities of the placement system, not the outline centering
3. Standard tolerance of  $\pm 0.05$  mm is recommended.
4. 3.5 N placement force is recommended. Too much placement force can lead to squeezed out solder paste and cause solder joints to short. Too low placement force can lead to insufficient contact between package and solder paste that could cause open solder joints or badly centered packages.
5. To improve the package placement accuracy, a bottom side optical control should be performed with a high resolution tool.
6. For assembly, a perfect supporting of the PCB (all the more on flexible PCB) is recommended during solder paste printing, pick and place and reflow soldering by using optimized tools.

### 3.3 PCB design preference

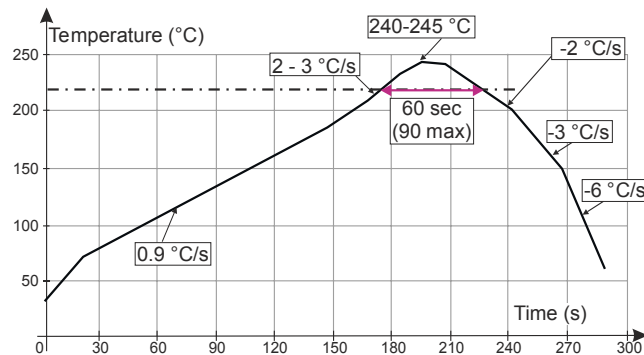
1. To control the solder paste amount, the closed via is recommended instead of open vias.
2. The position of tracks and open vias in the solder area should be well balanced. A symmetrical layout is recommended, to avoid any tilt phenomena caused by asymmetrical solder paste due to solder flow away.

Figure 14. Printed circuit board layout recommendations



### 3.4 Reflow profile

Figure 15. ST ECOPACK® recommended soldering reflow profile for PCB mounting

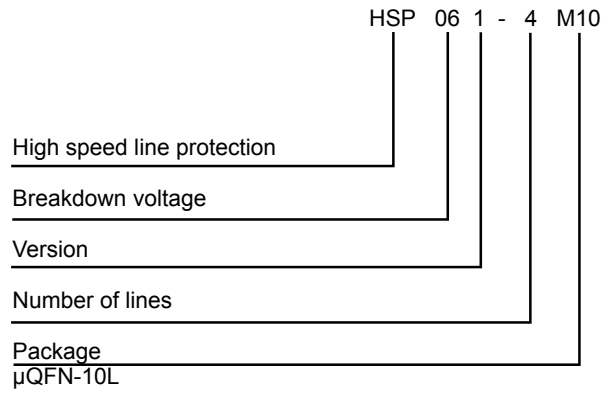


Note: Minimize air convection currents in the reflow oven to avoid component movement.

Note: Maximum soldering profile corresponds to the latest IPC/JEDEC J-STD-020.

## 4 Ordering information

**Figure 16. Ordering information scheme**



**Table 4. Ordering information**

Order code	Marking	Package	Weight	Base qty.	Delivery mode
HSP061-4M10	H4M	$\mu$ QFN-10L	3.27 mg	3000	Tape and reel



## Revision history

**Table 5. Document revision history**

Date	Version	Changes
05-Sep-2012	1	Initial release.
18-Oct-2012	2	Updated VPP in Table 1.
17-Jun-2014	3	Updated Figure 12 and reformatted to current standard.
13-Feb-2018	5	Added a note for <a href="#">Figure 11. Marking</a> .

**IMPORTANT NOTICE – PLEASE READ CAREFULLY**

STMicroelectronics NV and its subsidiaries (“ST”) reserve the right to make changes, corrections, enhancements, modifications, and improvements to ST products and/or to this document at any time without notice. Purchasers should obtain the latest relevant information on ST products before placing orders. ST products are sold pursuant to ST’s terms and conditions of sale in place at the time of order acknowledgement.

Purchasers are solely responsible for the choice, selection, and use of ST products and ST assumes no liability for application assistance or the design of Purchasers’ products.

No license, express or implied, to any intellectual property right is granted by ST herein.

Resale of ST products with provisions different from the information set forth herein shall void any warranty granted by ST for such product.

ST and the ST logo are trademarks of ST. All other product or service names are the property of their respective owners.

Information in this document supersedes and replaces information previously supplied in any prior versions of this document.

© 2018 STMicroelectronics – All rights reserved

## X-ON Electronics

Largest Supplier of Electrical and Electronic Components

*Click to view similar products for [ESD Suppressors / TVS Diodes](#) category:*

*Click to view products by [STMicroelectronics](#) manufacturer:*

Other Similar products are found below :

[60KS200C](#) [D12V0H1U2WS-7](#) [D18V0L1B2LP-7B](#) [82356050220](#) [D5V0M5U6V-7](#) [NTE4902](#) [P4KE27CA](#) [P6KE11CA](#) [P6KE39CA-TP](#)  
[P6KE8.2A](#) [SA110CA](#) [SA60CA](#) [SA64CA](#) [SMBJ12CATR](#) [SMBJ8.0A](#) [SMLJ30CA-TP](#) [ESD101-B1-02ELS E6327](#) [ESD112-B1-02EL E6327](#)  
[ESD119B1W01005E6327XTSA1](#) [ESD5V0J4-TP](#) [ESD5V0L1B02VH6327XTSA1](#) [ESD7451N2T5G](#) [19180-510](#) [CPDT-5V0USP-HF](#)  
[3.0SMCJ33CA-F](#) [3.0SMCJ36A-F](#) [HSPC16701B02TP](#) [D3V3Q1B2DLP3-7](#) [D55V0M1B2WS-7](#) [DESD5V0U1BL-7B](#) [DRTR5V0U4SL-7](#)  
[SCM1293A-04SO](#) [ESD200-B1-CSP0201 E6327](#) [ESD203-B1-02EL E6327](#) [SM12-7](#) [SMF8.0A-TP](#) [SMLJ45CA-TP](#) [CEN955 W/DATA](#)  
[82350120560](#) [82356240030](#) [VESD12A1A-HD1-GS08](#) [CPDUR5V0R-HF](#) [CPDUR24V-HF](#) [CPDQC5V0U-HF](#) [CPDQC5V0USP-HF](#)  
[CPDQC5V0-HF](#) [D1213A-01LP4-7B](#) [D1213A-02WL-7](#) [ESDLIN1524BJ-HQ](#) [5KP100A](#)