

Automotive grade 18 V dual-line high speed port protection

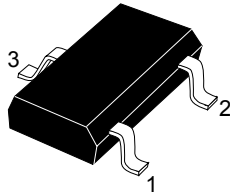

SOT323-3L
(Jedec TO-236)

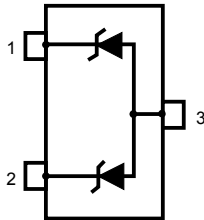

Functional diagram

Features

- AEC-Q101 qualified 
- Flow-through routing to keep signal integrity
- Large bandwidth: 1.7 GHz
- Ultra low capacitance: 2.1 pF
- Operating junction temperature range: -55 °C to 150 °C
- RoHS compliant and halogen free
- Complies with ISO ISO 10605 / IEC 61000-4-2 - C = 150 pF, R = 330 Ω exceeds level 4
 - ±12 kV (contact discharge)
 - ±30 kV (air discharge)
- Complies with ISO 10605 - C = 330 pF, R = 330 Ω
 - ±10 kV (contact discharge)
 - ±30 kV (air discharge)
- Complies with ISO 10605 - C = 330 pF, R = 2 kΩ
 - ±30 kV (contact discharge)
 - ±30 kV (air discharge)

Application

- USB 1.1 and USB2.0
- NFC
- Other high speed signals

Product status link

[HSP181-2W3Y](#)

Product summary

| | |
|-------------------|---------------|
| Order code | HSP181-2W3Y |
| Marking | H8Y |
| Package | SOT323-3L |
| Packing | Tape and reel |

Description

The HSP181-2W3Y is an ESD array designed for high-speed differential lines. The V_{RM} at 18 V makes it compatible with a short-to-battery hazard in vehicles.

The HSP181-2W3Y is also compatible with the maximum signal voltage (18 V) on the antenna of NFC readers and can thus efficiently protect NFC antenna I/O of NFC ICs.

The 2.1 pF low parasitic capacitance and the 1.7 GHz bandwidth provides enough room to preserve the signal integrity of USB 2.0 or NFC signals.

The HSP181-2W3Y is housed in SOT323-3L.

1 Characteristics

Table 1. Absolute maximum ratings ($T_{amb} = 25\text{ }^{\circ}\text{C}$)

| Symbol | Parameter | Value | Unit | |
|-----------|--|-------------------|--------------------|----|
| V_{PP} | ISO10605 / IEC 61000-4-2 (C = 150 pF, R = 330 Ω) | Contact discharge | 12 | kV |
| | | Air discharge | 30 | |
| | ISO10605 (C = 330 pF, R = 330 Ω) | Contact discharge | 10 | |
| | | Air discharge | 30 | |
| | ISO10605 (C = 330 pF, R = 2 k Ω) | Contact discharge | 30 | |
| | | Air discharge | 30 | |
| P_{PP} | Peak pulse power dissipation (8/20 μs) | 50 | W | |
| I_{PP} | Peak Pulse current (8/20 μs) | 2 | A | |
| T_{stg} | Storage temperature range | -65 to +150 | $^{\circ}\text{C}$ | |
| T_j | Operating junction temperature range | -55 to +150 | $^{\circ}\text{C}$ | |
| T_L | Maximum lead temperature for soldering during 10 s | 260 | $^{\circ}\text{C}$ | |

Figure 1. Electrical characteristics - parameter definitions

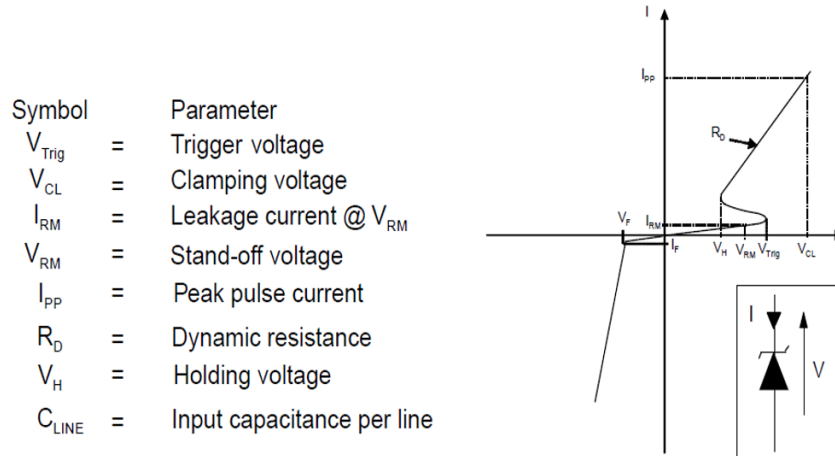

Table 2. Electrical characteristics (values) ($T_{amb} = 25^{\circ}C$)

| Symbol | Test conditions | Min. | Typ. | Max. | Unit |
|------------|---|------|------|------|----------|
| V_{TRIG} | Higher voltage than V_{TRIG} guarantees the protection turn-on | 21.5 | | 30 | V |
| V_H | Lower voltage than V_H guarantees the protection turn-off | 18 | | | V |
| V_{RM} | Stand-off voltage | | | 18 | V |
| I_{RM} | $V_{RM} = 18\text{ V}$ | | | 50 | nA |
| V_{CL} | TLP 100 ns, $I_{PP} = 16\text{ A}$ | | 33 | | V |
| V_{CL} | 8/20 μs waveform, $I_{PP} = 2\text{ A}$ | | | 29 | V |
| C_{LINE} | $V_{LINE} = 0\text{ V}$, $f = 1\text{ MHz}$, $V_{OSC} = 30\text{ mV}$ | | 2.1 | 2.5 | pF |
| BW | Bandwidth S21 = -3dB | | 1.7 | | GHz |
| R_D | Pulse duration 100 ns | | 0.7 | | Ω |

1.1 Characteristics (curves)

Figure 2. Leakage current versus junction temperature

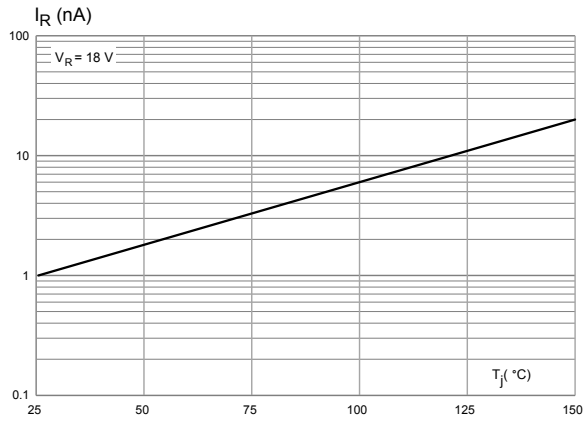

Figure 3. Junction capacitance versus reverse applied voltage

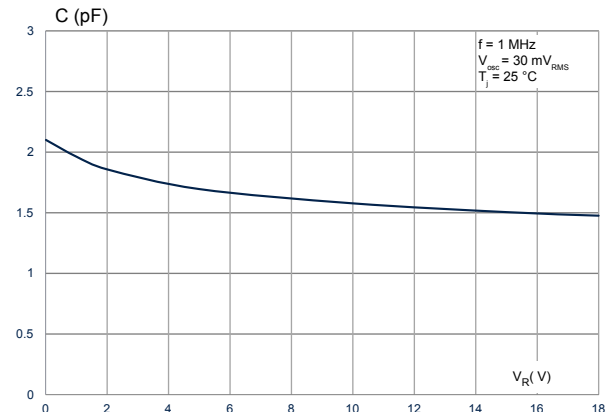

Figure 4. ESD response to ISO 10605 - C = 150 pF, R = 330 Ω (+8 kV contact discharge)

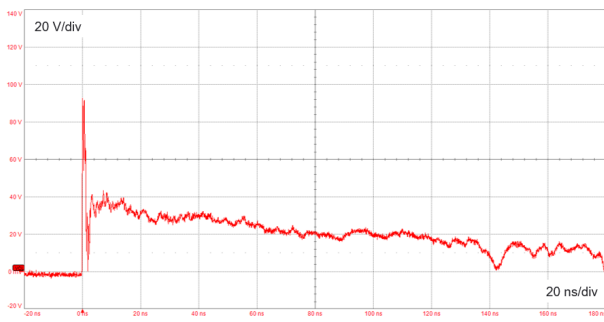

Figure 5. ESD response to ISO 10605 - C = 150 pF, R = 330 Ω (-8 kV contact discharge)



Figure 6. TLP

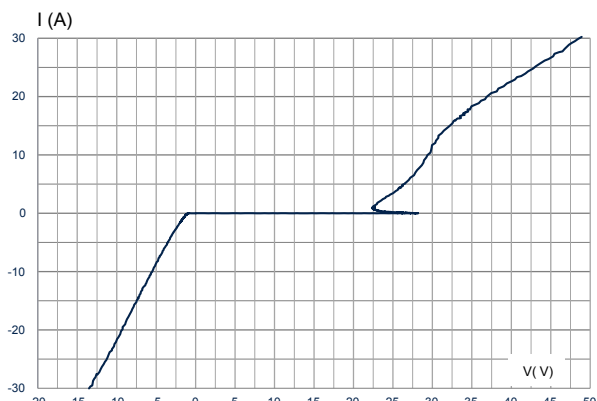

Figure 7. S₂₁ attenuation

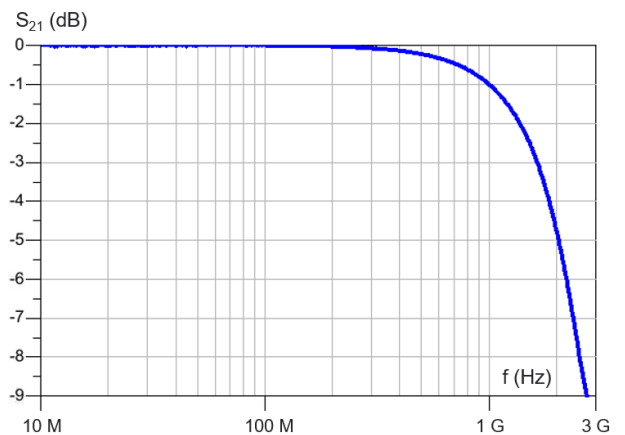

Figure 8. ISO7637-3, fast transient pulse 3a ($U_s = -150\text{ V}$)

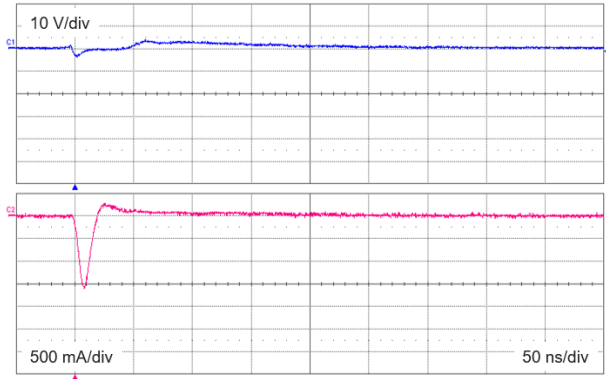

Figure 9. ISO7637-3, fast transient pulse 3b ($U_s = +150\text{ V}$)

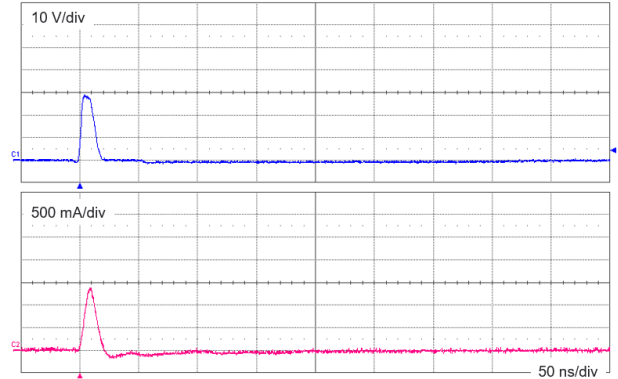

Figure 10. ISO7637-3, slow transient pulse - negative 2a ($U_s = -85\text{ V}$)

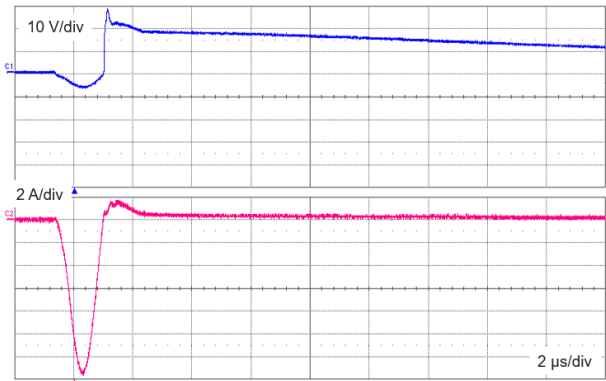

Figure 11. ISO7637-3, slow transient pulse - positive 2a ($U_s = +85\text{ V}$)

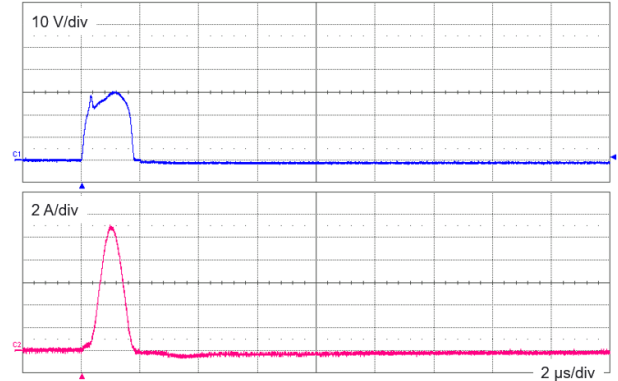

Figure 12. USB 2.0 high speed 480 Mbps eye diagram, template 1, without HSP181-2W3Y

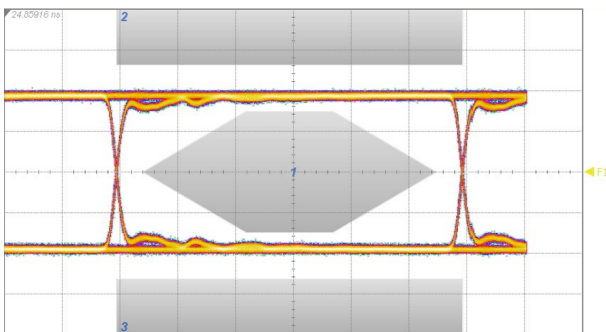
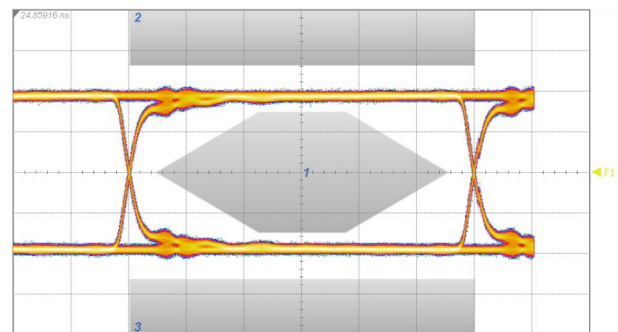

Figure 13. USB 2.0 high speed 480 Mbps eye diagram, template 1, with HSP181-2W3Y



2 Package information

In order to meet environmental requirements, ST offers these devices in different grades of **ECOPACK** packages, depending on their level of environmental compliance. ECOPACK specifications, grade definitions and product status are available at: www.st.com. ECOPACK is an ST trademark.

2.1 SOT323-3L package information

- Epoxy meets UL 94,V0
- Lead-free package

Figure 14. SOT323-3L package outline

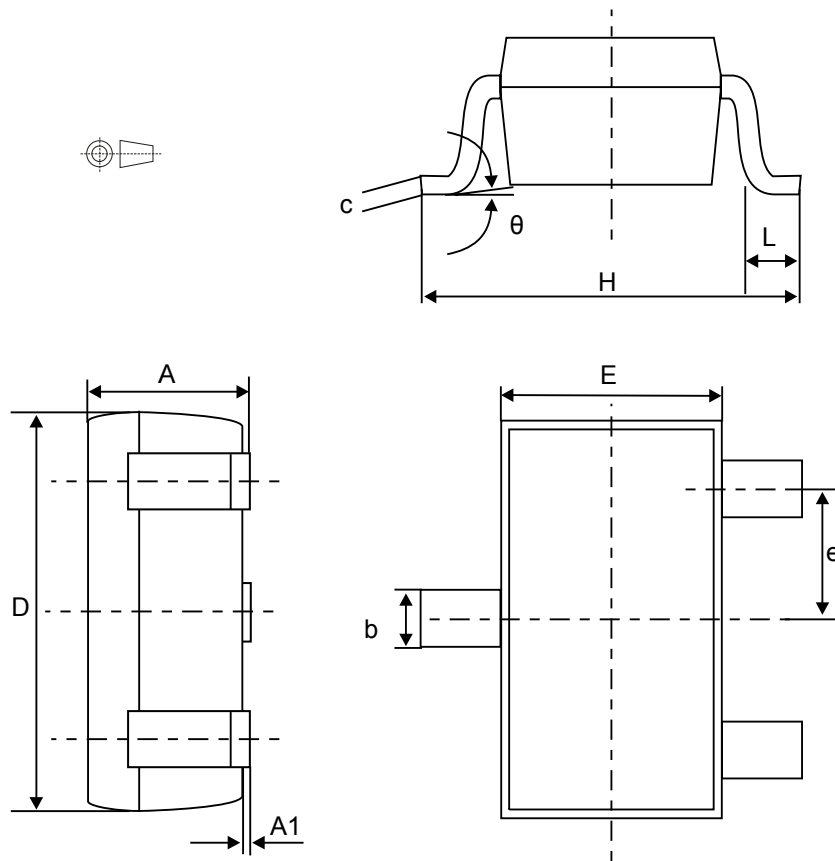

Table 3. SOT323-3L package mechanical data

| Ref. | Dimensions | | | | | |
|------|-------------|------|------|-----------------------|--------|--------|
| | Millimeters | | | Inches ⁽¹⁾ | | |
| | Min. | Typ. | Max. | Min. | Typ. | Max. |
| A | 0.80 | | 1.10 | 0.031 | | 0.043 |
| A1 | 0.00 | | 0.10 | 0.000 | | 0.003 |
| b | 0.25 | | 0.40 | 0.0098 | | 0.0157 |
| c | 0.10 | | 0.26 | 0.003 | | 0.0102 |
| D | 1.80 | 2.00 | 2.20 | 0.070 | 0.078 | 0.086 |
| E | 1.15 | 1.25 | 1.35 | 0.0452 | 0.0492 | 0.0531 |
| e | 0.60 | 0.65 | 0.70 | 0.024 | 0.026 | 0.028 |
| H | 1.80 | 2.10 | 2.40 | 0.070 | 0.082 | 0.094 |
| L | 0.10 | 0.20 | 0.30 | 0.004 | 0.008 | 0.012 |
| Θ | | 0 | 30° | 0 | | 30° |

1. Values in inches are converted from mm and rounded to 3 or 4 decimal digits.

2.2 Packing and marking information

Figure 15. Marking layout (refer to ordering information table for marking)

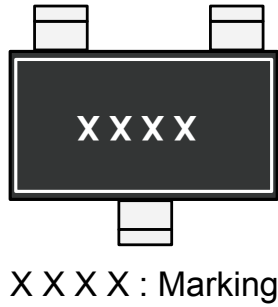

Figure 16. Package orientation in reel

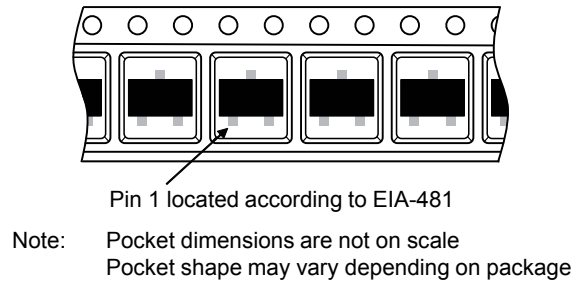

Figure 17. Tape leader and trailer dimensions

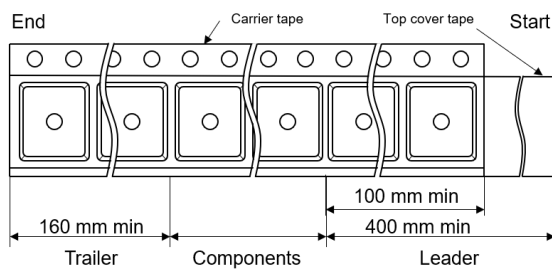

Figure 18. Tape and reel orientation

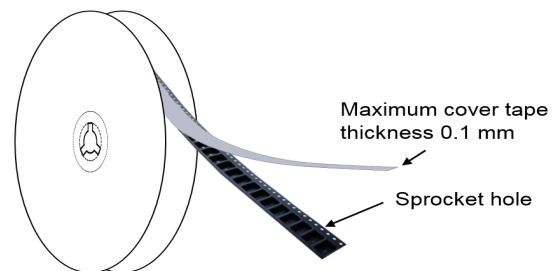

Figure 19. Reel dimensions (mm)

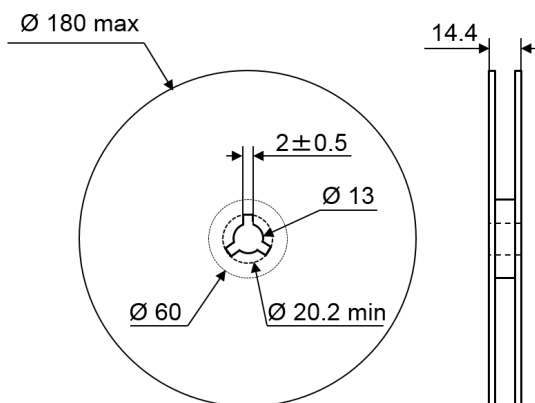

Figure 20. Inner box dimensions (mm)

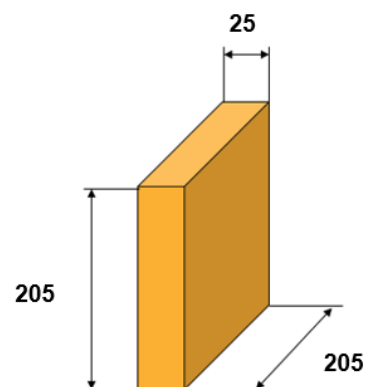
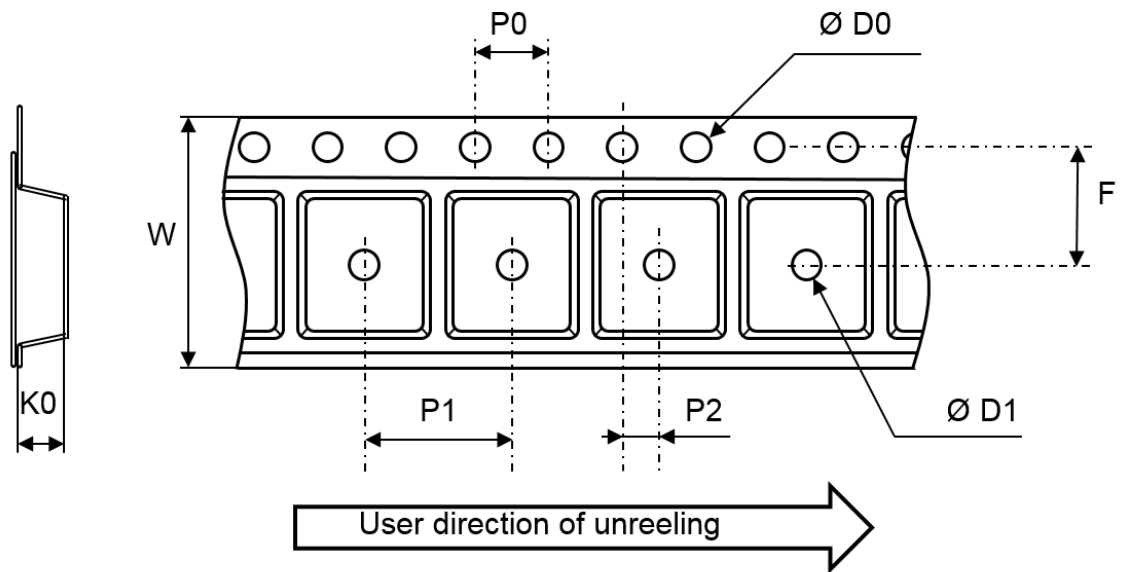

Figure 21. Tape outline



Note: Pocket dimensions are not on scale
Pocket shape may vary depending on package

Table 4. Tape and reel mechanical data

| Ref. | Dimensions | | |
|------|-------------|------|------|
| | Millimeters | | |
| | Min. | Typ. | Max. |
| D0 | 1.50 | | 1.60 |
| D1 | 0.90 | | |
| F | 3.45 | 3.50 | 3.55 |
| K0 | 1.10 | 1.20 | 1.30 |
| P0 | 3.90 | 4.00 | 4.10 |
| P1 | 3.90 | 4.00 | 4.10 |
| P2 | 1.95 | 2.00 | 2.05 |
| W | 7.90 | 8.00 | 8.30 |

3 Recommendation on PCB assembly

3.1 Recommended footprint

Figure 22. Recommended footprint in mm

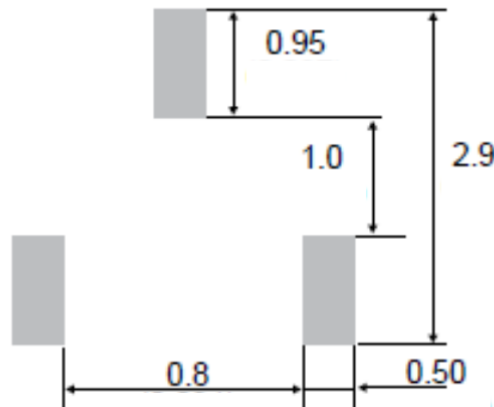

3.2 Stencil opening design

Stencil opening thickness: 75 μm / 3 mils

Figure 23. Stencil opening recommendations

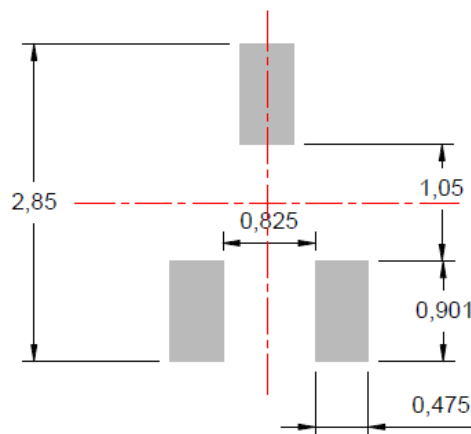

3.3 Solder paste

1. Halide-free flux, qualification ROL0 according to ANSI/J-STD-004.
2. "No clean" solder paste recommended.
3. Tack force high enough to resist component displacement during PCB movement.
4. Particles size 20-38 μm per IPCJ STD-005.

3.4 Placement

1. It is recommended to use leads recognition instead of package outline for accurate placement on footprint with adequate resolution tool.
2. Tolerance of $\pm 50 \mu\text{m}$ is recommended.
3. 1.0 N placement force is recommended. Too much placement force can lead to squeezed out solder paste and cause solder joints to short. Too low placement force can lead to insufficient contact between package and solder paste that could cause open solder joints or badly centered packages.
4. For assembly, a perfect supporting of the PCB (all the more on flexible PCB) is recommended during solder paste printing, pick and place and reflow soldering by using optimized tools.

3.5 PCB design preference

1. Any via around or inside the footprint area must be closed to avoid solderpaste migration in the via.
2. Position and dimensions of the tracks should be well balanced. A symmetrical layout is recommended to prevent assembly troubles.

3.6 Reflow profile

Figure 24. ST ECOPACK[®] recommended soldering reflow profile for PCB mounting

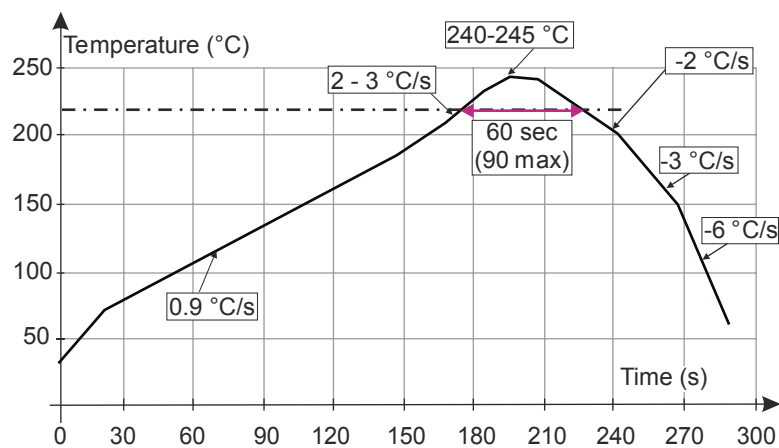

Note: Minimize air convection currents in the reflow oven to avoid component movement.

4 Ordering information

Table 5. Ordering information

| Order code | Marking ⁽¹⁾ | Package | Weight | Base qty. | Delivery mode |
|-------------|------------------------|-----------|---------|-----------|---------------|
| HSP181-2W3Y | H8Y | SOT323-3L | 6.46 mg | 3000 | Tape and reel |

1. The marking can be rotated by multiples of 90° to differentiate assembly location

Revision history

Table 6. Document revision history

| Date | Revision | Changes |
|-------------|----------|--|
| 29-Sep-2021 | 1 | Initial release. |
| 31-Jan-2022 | 2 | Updated Section ■ Disclaimer Updated Section Application Updated Section Description |
| 27-Jun-2022 | 3 | Added Figure 12 and Figure 13 . |

IMPORTANT NOTICE – READ CAREFULLY

STMicroelectronics NV and its subsidiaries (“ST”) reserve the right to make changes, corrections, enhancements, modifications, and improvements to ST products and/or to this document at any time without notice. Purchasers should obtain the latest relevant information on ST products before placing orders. ST products are sold pursuant to ST’s terms and conditions of sale in place at the time of order acknowledgment.

Purchasers are solely responsible for the choice, selection, and use of ST products and ST assumes no liability for application assistance or the design of purchasers’ products.

No license, express or implied, to any intellectual property right is granted by ST herein.

Resale of ST products with provisions different from the information set forth herein shall void any warranty granted by ST for such product.

ST and the ST logo are trademarks of ST. For additional information about ST trademarks, refer to www.st.com/trademarks. All other product or service names are the property of their respective owners.

Information in this document supersedes and replaces information previously supplied in any prior versions of this document.

© 2022 STMicroelectronics – All rights reserved

X-ON Electronics

Largest Supplier of Electrical and Electronic Components

Click to view similar products for [STMicroelectronics](#) manufacturer:

Other Similar products are found below :

[046547CB](#) [077-0096-013](#) [1.5KE100A](#) [1.5KE100CA](#) [1.5KE120A](#) [1.5KE12CA](#) [1.5KE150A](#) [1.5KE150CA](#) [1.5KE15A](#) [1.5KE15CA](#)
[1.5KE180A](#) [1.5KE180CA](#) [1.5KE18A](#) [1.5KE18CA](#) [1.5KE18CA](#) [1.5KE200A](#) [1.5KE200ARL](#) [1.5KE200CA](#) [1.5KE220A](#) [1.5KE220CA](#)
[1.5KE22A](#) [1.5KE24A](#) [1.5KE24CA](#) [1.5KE250A](#) [1.5KE250CA](#) [1.5KE250CA](#) [1.5KE27A](#) [1.5KE300A](#) [1.5KE300CA](#) [1.5KE30A](#) [1.5KE30CA](#)
[1.5KE33A](#) [1.5KE33A](#) [1.5KE33CA](#) [1.5KE350A](#) [1.5KE350CA](#) [1.5KE36A](#) [1.5KE36CA](#) [1.5KE39A](#) [1.5KE39CA](#) [1.5KE39CA](#) [1.5KE400A](#)
[1.5KE400ARL](#) [1.5KE400CA](#) [1.5KE440A](#) [1.5KE440CA](#) [1.5KE47A](#) [1.5KE47CARL](#) [1.5KE56A](#) [1.5KE62A](#)