

High-resolution, high-stability 3-axis digital accelerometer

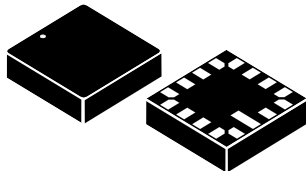

Ceramic cavity LGA-16
(5x5x1.7 mm)

Features

- 3-axis, $\pm 2.5\text{ g}$ full-scale
- Ultra-low noise performance: $45\ \mu\text{g}/\sqrt{\text{Hz}}$
- Excellent stability over temperature ($<0.4\ \text{mg}/^\circ\text{C}$) and time
- 16-bit data output
- SPI 4-wire digital output interface
- Embedded FIFO (depth 32 levels)
- Embedded temperature sensor
- 12-bit temperature data output
- High shock survivability
- Extended operating temperature range ($-40\ ^\circ\text{C}$ to $+85\ ^\circ\text{C}$)
- ECOPACK, RoHS and “Green” compliant

Applications

- Precision inclinometer
- Antenna and platform pointing and leveling
- Leveling instruments

Description

The IIS3DHHHC is an ultra-low noise, high-stability three-axis linear accelerometer.

The IIS3DHHHC has a full scale of $\pm 2.5\text{ g}$ and is capable of providing the measured accelerations to the application through an SPI 4-wire digital interface.

The sensing element is manufactured using a dedicated micromachining process developed by STMicroelectronics to produce inertial sensors and actuators on silicon wafers.

The IC interface is manufactured using a CMOS process that allows a high level of integration to design a dedicated circuit which is trimmed to better match the characteristics of the sensing element.

The IIS3DHHHC is available in a high-performance (low-stress) ceramic cavity land grid array (CC LGA) package and can operate within a temperature range of $-40\ ^\circ\text{C}$ to $+85\ ^\circ\text{C}$.

Product status link	
IIS3DHHHC	
Product summary	
Order code	IIS3DHHCTR
Temperature range [°C]	-40 to +85
Package	CC LGA-16 (5 x 5 x 1.7 mm)
Packing	Tape and reel
Product label	
	
Product resources	
AN5146 (IIS3DHHHC) TN0018 (Design and soldering)	

1 Pin description

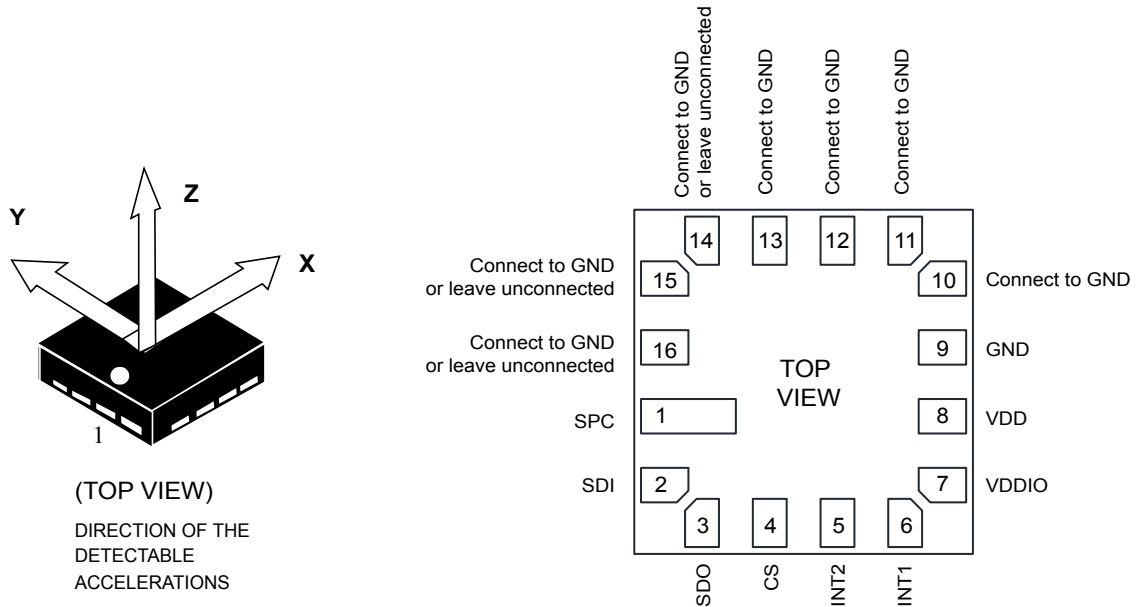
Figure 1. Pin connections

Table 1. Pin description

Pin#	Name	Function
1	SPC	Clock line for SPI 4-wire interface (SPC)
2	SDI	Serial data input (SDI) line for SPI 4-wire interface
3	SDO	Serial data output (SDO) line for SPI 4-wire interface
4	CS	SPI chip-select line (CS)
5	INT2	Programmable interrupt 2 generated according to a configurable FIFO threshold in a dedicated register
6	INT1	Programmable interrupt 1 generated according to a configurable FIFO threshold in a dedicated register
7	Vdd_IO	Power supply for I/O pins Recommended power supply decoupling capacitor (100 nF)
8	Vdd	Power supply Recommended power supply decoupling capacitors (100 nF ceramic in parallel with 10 µF aluminum)
9	GND	0 V power supply
10	Reserved	Connect to GND
11	Reserved	Connect to GND
12	Reserved	Connect to GND
13	Reserved	Connect to GND
14	Reserved	Connect to GND or leave unconnected
15	Reserved	Connect to GND or leave unconnected
16	Reserved	Connect to GND or leave unconnected

2 Mechanical and electrical specifications

2.1 Mechanical characteristics

@ Vdd = 2.8 V, T = 25 °C unless otherwise noted.

Table 2. Mechanical characteristics

Symbol	Parameter	Test condition	Min. ⁽¹⁾	Typ. ⁽²⁾	Max. ⁽¹⁾	Unit
FS	Measurement range ⁽³⁾			±2.5		g
So	Sensitivity ⁽⁴⁾		-7%	0.076	+7%	mg/digit
TCSO	Sensitivity change vs. temperature	From -40 °C to +85 °C, delta from 25°C	-1.35	0.7	+1.35	%
Off	Zero-g level offset accuracy ⁽⁵⁾		-35	±20	+35	mg
TCOff	Zero-g level change vs. temperature ⁽⁶⁾	From -40 °C to +85 °C, delta from 25 °C	-0.4		0.4	mg/°C
NL	Non linearity	Best-fit straight line			2	% FS
Zgn	Zero-g noise density	FS = ±2.5 g		45	65	µg/√(Hz)
ODR	Digital output data rate			1.1		kHz
Bw	Bandwidth	For both FIR and IIR filters		235 or 440		Hz
StartT	Startup time	For cold start condition			150	ms
ST	Self-test positive difference ⁽⁷⁾	X, Y-axis Z-axis	75 75		650 1400	mg
Top	Operating temperature range		-40		+85	°C

1. Min/Max values are based on characterization results, not tested in production and not guaranteed.
2. Typical specifications are not guaranteed.
3. Sensor is designed with larger dynamic to avoid variation of FS limits in the operative bandwidth. Consequently to trim operations at factory final test.
4. Sensitivity range after MSL3 preconditioning.
5. Typical zero-g level offset value after MSL3 preconditioning.
6. Valid if OFF_TCOMP_EN in CTRL_REG4 (23h) is set to '1'. Min/max at 3 sigma. Based on characterization data for a limited number of samples, not measured during final test for production.
7. Self-test positive difference is defined as: OUTPUT[mg](CTRL_REG4 (23h) ST2, ST1 bits = 01) - OUTPUT[mg](CTRL_REG4 (23h) ST2, ST1 bits = 00) in steady state.

2.2 Electrical characteristics

@ Vdd = 2.8 V, T = 25 °C unless otherwise noted.

Table 3. Electrical characteristics

Symbol	Parameter	Test condition	Min.	Typ. ⁽¹⁾	Max.	Unit
Vdd	Supply voltage		1.71	2.8	3.6	V
Vdd_IO	I/O pins supply voltage		1.71		Vdd+0.1	V
Idd	Supply current			2.5	5	mA
V _{IH}	Digital high-level input voltage		0.7*Vdd_IO			V
V _{IL}	Digital low-level input voltage				0.3*Vdd_IO	V
V _{OH}	High-level output voltage	I _{OH} = 4 mA ⁽²⁾	Vdd_IO - 0.2			V
V _{OL}	Low-level output voltage	I _{OL} = 4 mA ⁽²⁾			0.2	V
Top	Operating temperature range		-40		+85	°C
SPI_Fr	SPI frequency	4-wire interface		5	10	MHz
Trise	Time for power supply to rise ⁽³⁾		0.01		100	ms
Twait	Time delay between Vdd_IO and Vdd ⁽³⁾		0		10	ms

1. Typical specifications are not guaranteed.

2. 4 mA is the maximum driving capability, i.e. the maximum DC current that can be sourced/sunk by the digital pad in order to guarantee the correct digital output voltage levels V_{OH} and V_{OL}.

3. Please refer to Figure 2. Recommended power-up sequence for more details.

2.2.1 Recommended power-up sequence

For the power-up sequence please refer to the following figure, where:

- Trise is the time for the power supply to rise from 10% to 90% of its final value
- Twait is the time delay between the end of the Vdd_IO ramp (90% of its final value) and the start of the Vdd ramp

In the power-down sequence Vdd and Vdd_IO can come down in any order.

Figure 2. Recommended power-up sequence

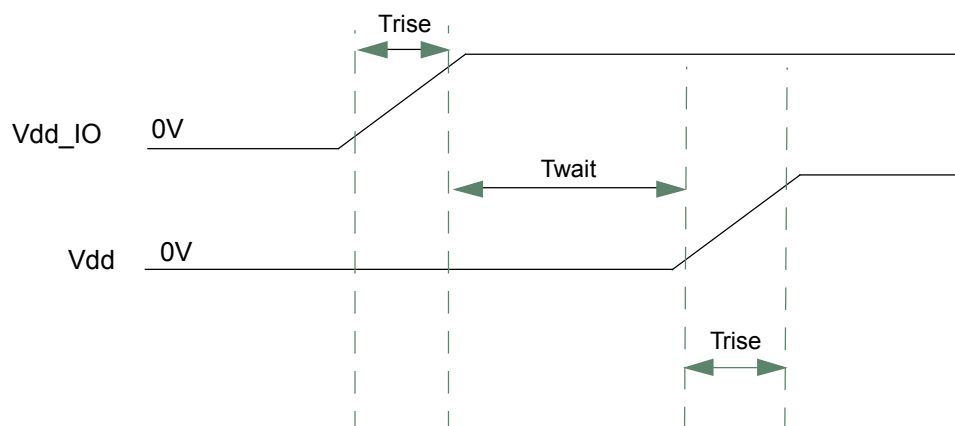

2.3 Temperature sensor characteristics

@ Vdd = 2.8 V, T = 25 °C unless otherwise noted.

Table 4. Temperature sensor characteristics

Symbol	Parameter	Test condition	Min. ⁽¹⁾	Typ. ⁽²⁾	Max. ⁽¹⁾	Unit
TSDr	Temperature sensor output change vs. temperature			16		digit/°C
Tn	Temperature sensor noise (<i>RMS</i>)				0.1	°C
Ta	Temperature accuracy		-15		+15	°C
TODR	Temperature refresh rate	Equal to ODR/16	62.5			Hz
TNL	Temperature nonlinearity	Best-fit straight line		5		% Top
Top	Operating temperature range		-40		+85	°C

1. Min/Max values are based on characterization results, not tested in production and not guaranteed

2. Typical specifications are not guaranteed.

3 Absolute maximum ratings

Stresses above those listed as “Absolute maximum ratings” may cause permanent damage to the device. This is a stress rating only and functional operation of the device under these conditions is not implied. Exposure to maximum rating conditions for extended periods may affect device reliability.

Table 5. Absolute maximum ratings

Symbol	Ratings	Maximum value	Unit
Vdd and Vdd_IO	Supply voltage	-0.3 to 4.8	V
T _{STG}	Storage temperature range	-40 to +85	°C
S _g	Acceleration g for 0.2 ms	10,000	g
ESD	Electrostatic discharge protection (HBM)	2	kV
V _{in}	Input voltage on any control pin (including CS, SPC, SDI, SDO)	-0.3 to Vdd_IO +0.3	V

Note: Supply voltage on any pin should never exceed 4.8 V.



This device is sensitive to mechanical shock, improper handling can cause permanent damage to the part.



This device is sensitive to electrostatic discharge (ESD), improper handling can cause permanent damage to the part.

4 Communication interface characteristics

4.1 SPI - serial peripheral interface

Subject to general operating conditions for Vdd and Top.

Table 6. SPI slave timing values

Symbol	Parameter	Value ⁽¹⁾		Unit
		Min	Max	
$t_{c(SPC)}$	SPI clock cycle	100		ns
$f_{c(SPC)}$	SPI clock frequency		10	MHz
$t_{su(CS)}$	CS setup time	5		ns
$t_{h(CS)}$	CS hold time	20		
$t_{su(SI)}$	SDI input setup time	5		
$t_{h(SI)}$	SDI input hold time	15		
$t_{v(SO)}$	SDO valid output time		35	
$t_{h(SO)}$	SDO output hold time	5		
$t_{dis(SO)}$	SDO output disable time		50	

1. Values are guaranteed at 10 MHz clock frequency for SPI 4 wires, based on characterization results, not tested in production

Figure 3. SPI slave timing diagram

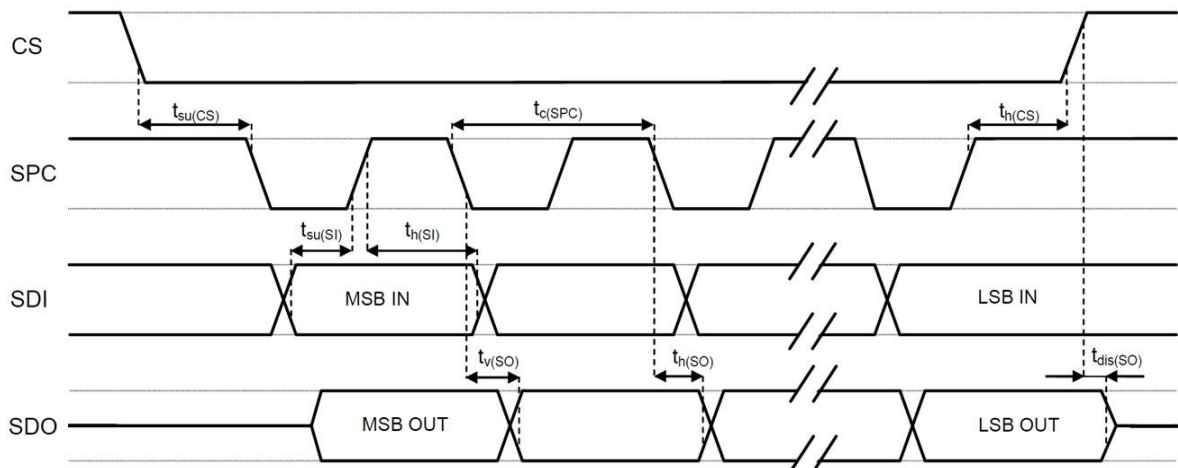

Note: Measurement points are done at $0.2 \cdot V_{dd_IO}$ and $0.8 \cdot V_{dd_IO}$, for both input and output ports. The SPI state machine is reset each time the CS signal is de-asserted.

4.2 SPI bus interface

The IIS3DHHHC SPI is a bus slave. The SPI allows writing to and reading from the registers of the device. The serial interface interacts with the application using 4 wires: **CS**, **SPC**, **SDI** and **SDO**.

Figure 4. Read and write protocol

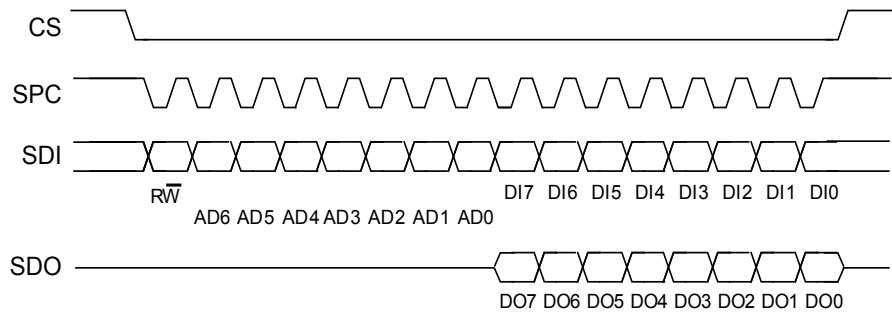

CS is the serial port enable and it is controlled by the SPI master. It goes low at the start of the transmission and goes back high at the end. **SPC** is the serial port clock and it is controlled by the SPI master. It is stopped high when **CS** is high (no transmission). **SDI** and **SDO** are respectively the serial port data input and output. These lines are driven at the falling edge of **SPC** and should be captured at the rising edge of **SPC**.

Both the read register and write register commands are completed in 16 clock pulses or in multiples of 8 in case of multiple read/write bytes. Bit duration is the time between two falling edges of **SPC**. The first bit (bit 0) starts at the first falling edge of **SPC** after the falling edge of **CS** while the last bit (bit 15, bit 23, ...) starts at the last falling edge of **SPC** just before the rising edge of **CS**.

bit 0: \overline{RW} bit. When 0, the data DI(7:0) is written into the device. When 1, the data DO(7:0) from the device is read. In latter case, the chip will drive **SDO** at the start of bit 8.

bit 1-7: address AD(6:0). This is the address field of the indexed register.

bit 8-15: data DI(7:0) (write mode). This is the data that is written into the device (MSb first).

bit 8-15: data DO(7:0) (read mode). This is the data that is read from the device (MSb first).

In multiple read/write commands further blocks of 8 clock periods will be added. When the **CTRL_REG1 (20h)** (IF_ADD_INC) bit is '0' the address used to read/write data remains the same for every block. When **CTRL_REG1 (20h)**(IF_ADD_INC) bit is '1' the address used to read/write data is increased at every block.

The function and the behavior of **SDI** and **SDO** remain unchanged.

4.2.1 SPI read

Figure 5. SPI read protocol

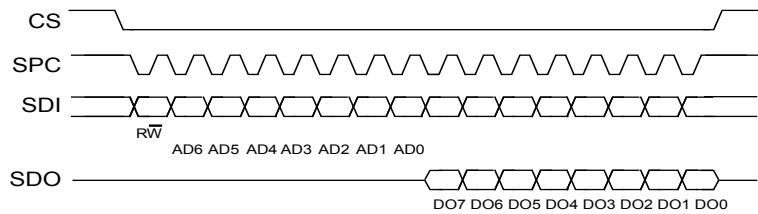

The SPI read command is performed with 16 clock pulses. The multiple byte read command is performed by adding blocks of 8 clock pulses to the previous one.

bit 0: READ bit. The value is 1.

bit 1-7: address AD(6:0). This is the address field of the indexed register.

bit 8-15: data DO(7:0) (read mode). This is the data that will be read from the device (MSb first).

bit 16-... : data DO(...-8). Further data in multiple byte reads.

Figure 6. Multiple byte SPI read protocol (2-byte example)

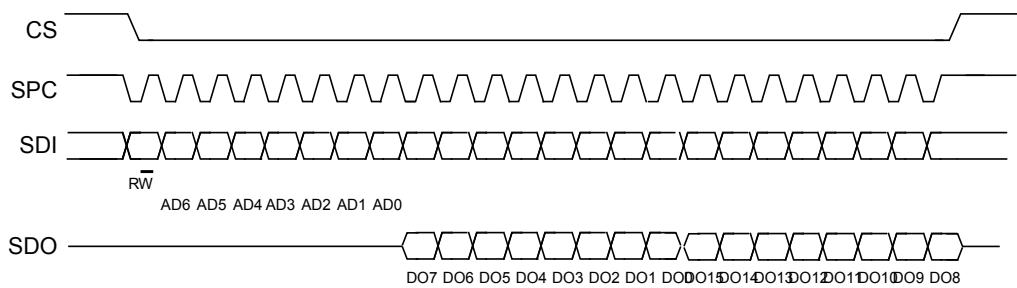

4.2.2 SPI write

Figure 7. SPI write protocol

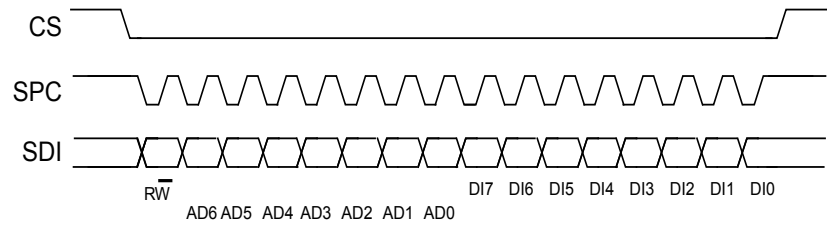

The SPI write command is performed with 16 clock pulses. The multiple byte write command is performed by adding blocks of 8 clock pulses to the previous one.

bit 0: WRITE bit. The value is 0.

bit 1 -7: address AD(6:0). This is the address field of the indexed register.

bit 8-15: data DI(7:0) (write mode). This is the data that is written inside the device (MSb first).

bit 16-... : data DI(...-8). Further data in multiple byte writes.

Figure 8. Multiple byte SPI write protocol (2-byte example)

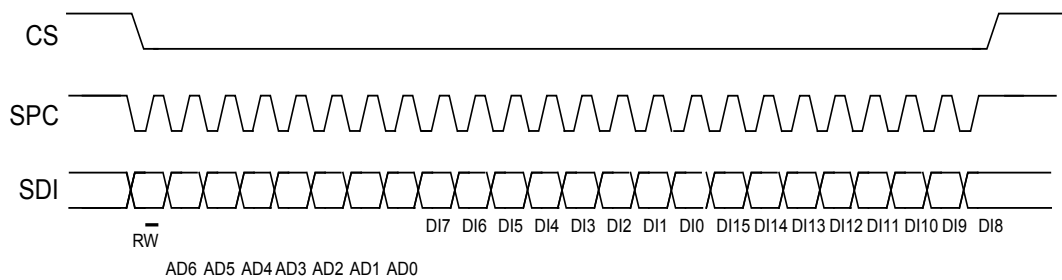

5 FIFO

The IIS3DHHC embeds 32 slots of 16-bit data FIFO for each of the accelerometer's three output channels, X, Y and Z. This allows consistent power saving for the system since the host processor does not need to continuously poll data from the sensor, but it can wake up only when needed and burst the significant data out from the FIFO. This buffer can work accordingly to five different modes: Bypass mode, FIFO mode, Continuous mode, Continuous-to-FIFO mode and Bypass-to-Continuous mode. Each mode is selected by the FMODE [2:0] bits in the [FIFO_CTRL \(2Eh\)](#) register. Programmable FIFO threshold status, FIFO overrun events and the number of unread samples stored are available in the [FIFO_SRC \(2Fh\)](#) register and can be set to generate dedicated interrupts on the INT1 and INT2 pins using the [INT1_CTRL \(21h\)](#) and [INT2_CTRL \(22h\)](#) registers.

[FIFO_SRC \(2Fh\)](#)(FTH) goes to '1' when the number of unread samples ([FIFO_SRC \(2Fh\)](#) (FSS5:0)) is greater than or equal to FTH [4:0] in [FIFO_CTRL \(2Eh\)](#). If [FIFO_CTRL \(2Eh\)](#) (FTH[4:0]) is equal to 0, [FIFO_SRC \(2Fh\)](#) (FTH) goes to '0'.

[FIFO_SRC \(2Fh\)](#)(OVRN) is equal to '1' if a FIFO slot is overwritten.

[FIFO_SRC \(2Fh\)](#)(FSS [5:0]) contains stored data levels of unread samples. When FSS [5:0] is equal to '000000', FIFO is empty. When FSS [5:0] is equal to '100000', FIFO is full and the unread samples are 32.

The FIFO feature is enabled by writing '1' in [CTRL_REG4 \(23h\)](#) (FIFO_EN).

To guarantee the correct acquisition of data during the switching into and out of FIFO mode, the first sample acquired must be discarded.

5.1 Bypass mode

In Bypass mode ([FIFO_CTRL \(2Eh\)](#)(FMODE [2:0]= 000), the FIFO is not operational, no data is collected in FIFO memory, and it remains empty with the only actual sample available in the output registers.

Bypass mode is also used to reset the FIFO when in FIFO mode.

As described in [Figure 9. Bypass mode](#), for each channel only the first address is used. When new data is available the old data is overwritten.

Figure 9. Bypass mode

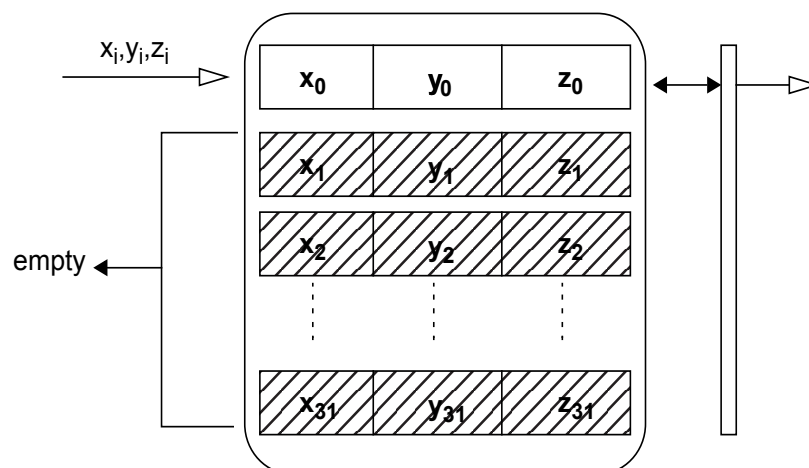

5.2 FIFO mode

In FIFO mode (**FIFO_CTRL (2Eh)** (FMODE [2:0] = 001) data from the output channels are stored in the FIFO memory until it is full, when 32 unread samples are stored in memory, data collecting is stopped.

To reset FIFO content, Bypass mode should be selected by writing **FIFO_CTRL (2Eh)** (FMODE [2:0]) to '000'. After this reset command, it is possible to restart FIFO mode, writing **FIFO_CTRL (2Eh)** (FMODE [2:0]) to '001'.

A FIFO threshold interrupt can be enabled (INT1_OVR bit in **INT1_CTRL (21h)** or INT2_OVR bit in **INT2_CTRL (22h)**) in order to be raised when the FIFO is filled to the level specified by the FTH[4:0] bits of **FIFO_CTRL (2Eh)**.

Figure 10. FIFO mode

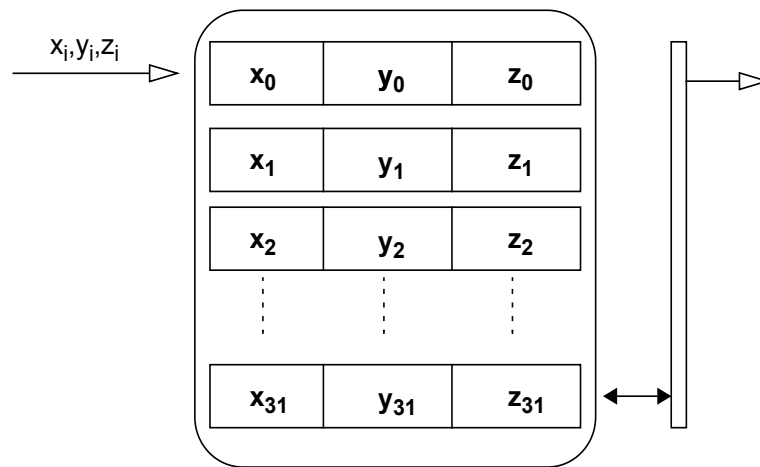

5.3 Continuous mode

Continuous mode (FIFO_CTRL (2Eh) (FMODE[2:0] = 110) provides a continuous FIFO update: when 32 unread samples are stored in memory, as new data arrives the oldest data is discarded and overwritten by the newer.

A FIFO threshold flag FIFO_SRC (2Fh)(FTH) is asserted when the number of unread samples in FIFO is greater than or equal to FIFO_CTRL (2Eh)(FTH4:0).

It is possible to route FIFO_SRC (2Fh)(FTH) to the INT1 pin by writing the INT1_FTH bit to '1' in register INT1_CTRL (21h) or to the INT2 pin by writing the INT2_FTH bit to '1' in register INT2_CTRL (22h).

A full-flag interrupt can be enabled (INT1_CTRL (21h) (INT_FSS5)= '1' or INT2_CTRL (22h) (INT_FSS5) = '1') when the FIFO becomes saturated and in order to read the contents all at once. If an overrun occurs, the oldest sample in FIFO is overwritten and the OVRN flag in FIFO_SRC (2Fh) is asserted.

In order to empty the FIFO before it is full, it is also possible to pull from FIFO the number of unread samples available in FIFO_SRC (2Fh) (FSS[5:0]).

Figure 11. Continuous mode

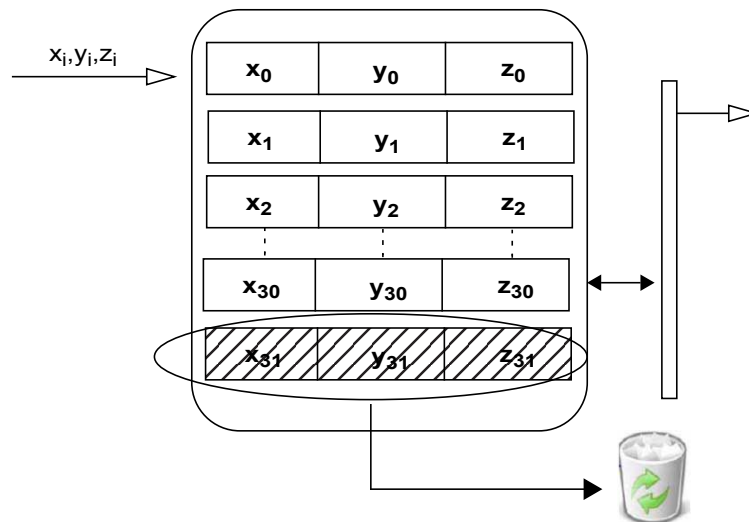

5.4 Continuous-to-FIFO mode

In Continuous-to-FIFO mode (FIFO_CTRL (2Eh)(FMODE [2:0] = 011), FIFO operates in Continuous mode and FIFO mode starts on the INT1 edge trigger event. When the FIFO is full, data collecting is stopped.

Figure 12. Continuous-to-FIFO mode

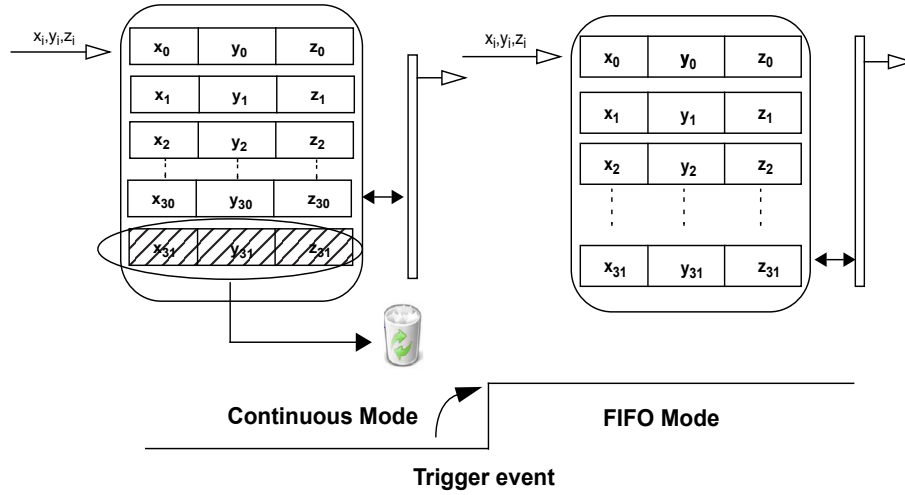
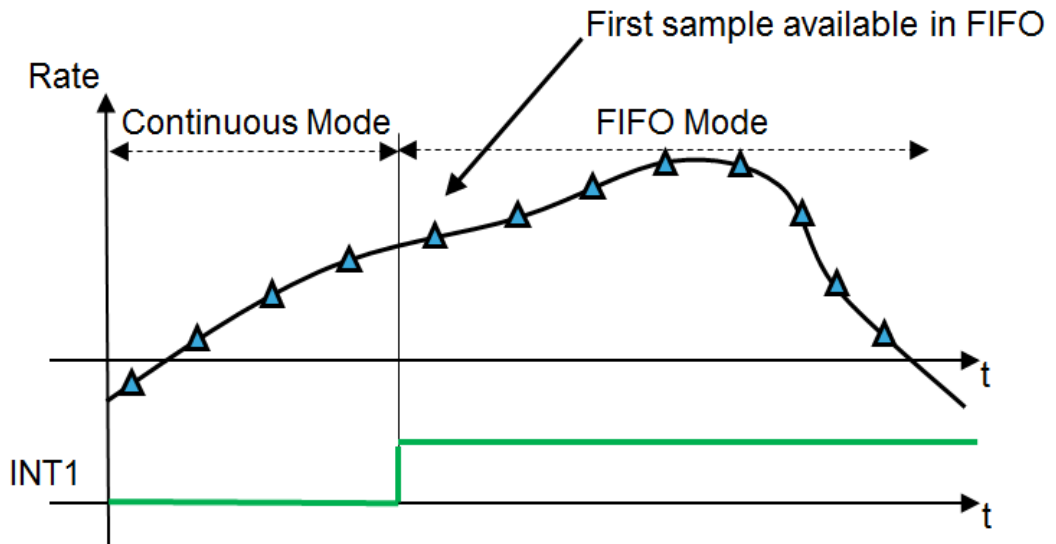

Figure 13. External asynchronous trigger to FIFO for Continuous-to-FIFO mode



5.5 Bypass-to-Continuous mode

In Bypass-to-Continuous mode (FIFO_CTRL (2Eh)(FMODE[2:0] = '100'), data measurement storage inside FIFO starts in Continuous mode on the INT1 edge trigger event, then the sample that follows the trigger is available in FIFO.

Figure 14. Bypass-to-Continuous mode

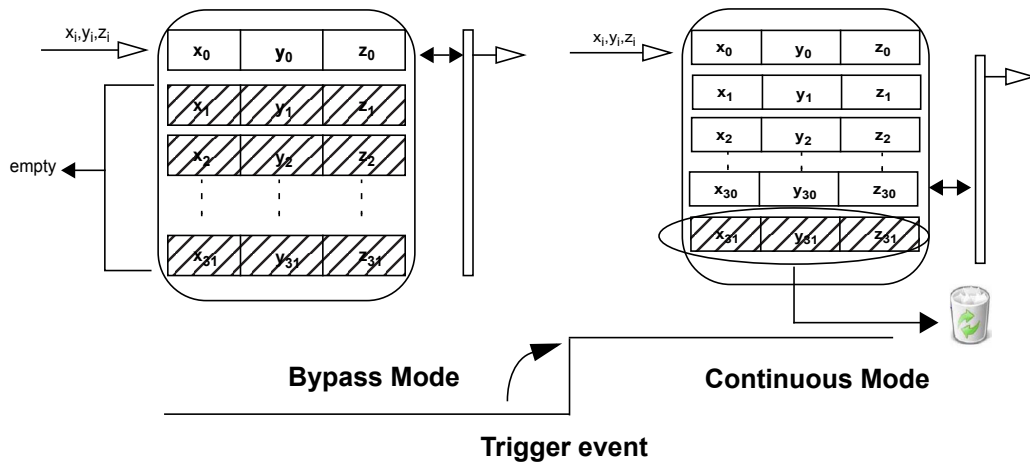
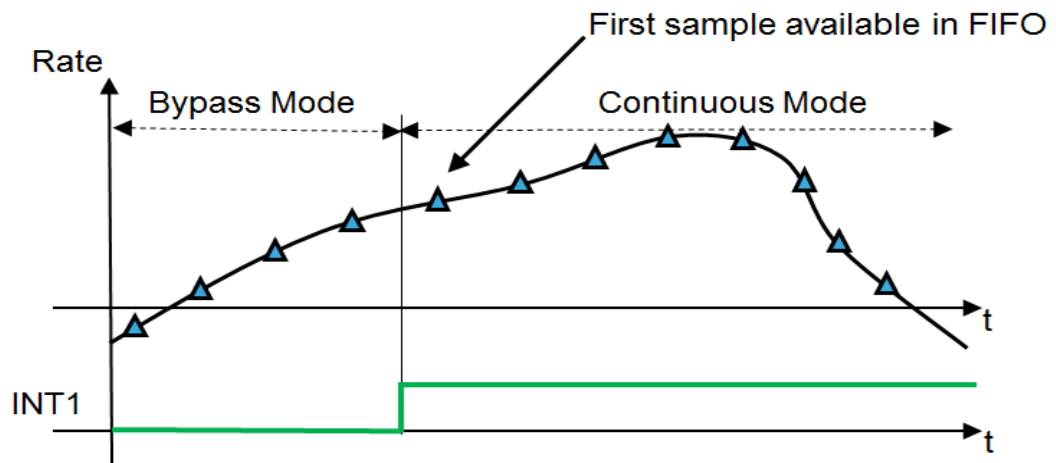

Figure 15. External asynchronous trigger to FIFO for Bypass-to-Continuous mode



6 Register mapping

The table given below provides a list of the 8/16-bit registers embedded in the device and the corresponding addresses.

Table 7. Register mapping

Name	Type	Register address		Default	Note
		Hex	Binary		
Reserved	--	00-0E	--	--	Reserved
WHO_AM_I	r	0F	00001111	00010001	
Reserved	--	10-1F	--	--	Reserved
CTRL_REG1	r/w	20	00100000	00000000	
INT1_CTRL	r/w	21	00100001	00000000	
INT2_CTRL	r/w	22	00100010	00000000	
CTRL_REG4	r/w	23	00100011	00000000	
CTRL_REG5	r/w	24	00100100	00000000	
OUT_TEMP_L	r	25	00100101	output	
OUT_TEMP_H	r	26	00100110	output	
STATUS	r	27	00100111	output	
OUT_X_L_XL	r	28	00101000	output	
OUT_X_H_XL	r	29	00101001	output	
OUT_Y_L_XL	r	2A	00101010	output	
OUT_Y_H_XL	r	2B	00101011	output	
OUT_Z_L_XL	r	2C	00101100	output	
OUT_Z_H_XL	r	2D	00101101	output	
FIFO_CTRL	r/w	2E	00101110	00000000	
FIFO_SRC	r	2F	00101111	output	
Reserved	--	30-32	--	--	Reserved

Registers marked as Reserved must not be changed. Writing to those registers may affect the correct behavior of the device.

Their content is automatically restored when the device is powered up.

7 Register description

The device contains a set of registers which are used to control its behavior and to retrieve linear acceleration and temperature data. The register addresses, consisting of 7 bits, are used to identify them and to write the data through the serial interface.

7.1 CTRL_REG1 (20h)

Control register 1

Table 8. CTRL_REG1 register

NORM_MOD_EN	IF_ADD_INC	0 ⁽¹⁾	0 ⁽¹⁾	BOOT	SW_RESET	DRDY_PULSE	BDU
-------------	------------	------------------	------------------	------	----------	------------	-----

1. This bit must be set to '0' for the correct operation of the device.

Table 9. CTRL_REG1 register description

NORM_MOD_EN	Normal mode enable. Default value: 0 (0: power down; 1: enabled)
IF_ADD_INC	Register address is automatically incremented during a multiple byte access with SPI serial interface. Default value: 1 (0: disabled; 1: enabled)
BOOT	Reboot memory content. Default value: 0 (0: normal mode; 1: reboot memory content ⁽¹⁾)
SW_RESET	Software reset. Default value: 0 With SW_RESET the values in the writable CTRL registers are changed to the default values. (0: normal mode; 1: reset device) This bit is cleared by hardware at the end of the operation.
DRDY_PULSE	Data-ready on INT1 pin. Default value: 0 (0: DRDY latched; 1: DRDY pulsed, pulse duration is 1/4 ODR)
BDU	Block Data Update. Default value: 0 (0: continuous update; 1: output registers not updated until MSB and LSB read)

1. Boot request is executed as soon as the internal oscillator is turned on. It is possible to set the bit while in power-down mode, in this case it will be served at the next normal mode.

7.2 INT1_CTRL (21h)

INT1 pin control register

Table 10. INT1_CTRL register

INT1_DRDY	INT1_BOOT	INT1_OVR	INT1_FSS5	INT1_FTH	INT1_EXT	0 ⁽¹⁾	0 ⁽¹⁾
-----------	-----------	----------	-----------	----------	----------	------------------	------------------

1. This bit must be set to '0' for the correct operation of the device.

INT1_DRDY	Accelerometer data ready on INT1 pin. Default value: 0 (0: disabled; 1: enabled)
INT1_BOOT	Boot status available on INT1 pin. Default value: 0 (0: disabled; 1: enabled)
INT1_OVR	Overflow flag on INT1 pin. Default value: 0 (0: disabled; 1: enabled)
INT1_FSS5	FSS5 full FIFO flag on INT1 pin. Default value: 0 (0: disabled; 1: enabled)
INT1_FTH	FIFO threshold flag on INT1 pin. Default value: 0 (0: disabled; 1: enabled)
INT1_EXT	INT1 pin configuration. Default value: 0 It configures the INT1 pad as output for FIFO flags or as external asynchronous input trigger to FIFO. INT2 pad is always available as output for FIFO flags. (0: INT1 as output interrupt; 1: INT1 as input channel)

7.3 INT2_CTRL (22h)

INT2 pin control register

Table 11. INT2_CTRL register

INT2_DRDY	INT2_BOOT	INT2_OVR	INT2_FSS5	INT2_FTH	0 ⁽¹⁾	0 ⁽¹⁾	0 ⁽¹⁾
-----------	-----------	----------	-----------	----------	------------------	------------------	------------------

1. This bit must be set to '0' for the correct operation of the device.

INT2_DRDY	Accelerometer data ready on INT2 pin. Default value: 0 (0: disabled; 1: enabled)
INT2_BOOT	Boot status available on INT2 pin. Default value: 0 (0: disabled; 1: enabled)
INT2_OVR	Overflow flag on INT2 pin. Default value: 0 (0: disabled; 1: enabled)
INT2_FSS5	FSS5 full FIFO flag on INT2 pin. Default value: 0 (0: disabled; 1: enabled)
INT2_FTH	FIFO threshold flag on INT2 pin. Default value: 0 (0: disabled; 1: enabled)

7.4 CTRL_REG4 (23h)

Control register 4

Table 12. CTRL_REG4 register

DSP_LP_TYPE	DSP_BW_SEL	ST2	ST1	PP_OD_INT2	PP_OD_INT1	FIFO_EN	OFF_TCOMP_EN
-------------	------------	-----	-----	------------	------------	---------	--------------

Table 13. CTRL_REG4 register description

DSP_LP_TYPE	Digital filtering selection. Default value: 0 (0: FIR Linear Phase; 1: IIR Nonlinear Phase)
DSP_BW_SEL	User-selectable bandwidth. Default value: 0 (0: 440 Hz typ.; 1: 235 Hz typ.)
ST [2:1]	Self-test enable. Default value: 00 (00: Self-test disabled; Other: See Table 14. Self-test mode selection)
PP_OD_INT2	Push-pull/open drain selection on INT2 pin. Default value: 0 (0: push-pull mode; 1: open drain mode)
PP_OD_INT1	Push-pull/open drain selection on INT1 pin. Default value: 0 (0: push-pull mode; 1: open drain mode)
FIFO_EN	FIFO memory enable. Default value: 0 (0: disabled; 1: enabled)
OFF_TCOMP_EN	Offset temperature compensation enable. Default value: 0 (0: disabled; 1: enabled)

Table 14. Self-test mode selection

ST2	ST1	Self-test mode
0	0	Normal mode
0	1	Positive sign self-test
1	0	Negative sign self-test
1	1	Not allowed

7.5 CTRL_REG5 (24h)

Control register 5

Table 15. CTRL_REG5 register

0 ⁽¹⁾	0 ⁽¹⁾	0 ⁽¹⁾	0 ⁽¹⁾	0 ⁽¹⁾	0 ⁽¹⁾	0 ⁽¹⁾	FIFO_SPI_HS_ON
------------------	------------------	------------------	------------------	------------------	------------------	------------------	----------------

1. This bit must be set to '0' for correct operation of the device.

Table 16. CTRL_REG5 register description

FIFO_SPI_HS_ON	Enables the SPI high speed configuration for the FIFO block that is used to guarantee a minimum duration of the window in which writing operation of RAM output is blocked. This bit is recommended for SPI clock frequencies higher than 6 MHz. Default value: 0 (0: not enabled; 1: enabled)
----------------	---

7.6 OUT_TEMP_L (25h), OUT_TEMP_H (26h)

Temperature data output register. L and H registers together express a 16-bit word in two's complement left-justified.

Table 17. OUT_TEMP_L register

Temp3	Temp2	Temp1	Temp0	0	0	0	0
-------	-------	-------	-------	---	---	---	---

Table 18. OUT_TEMP_H register

Temp11	Temp10	Temp9	Temp8	Temp7	Temp6	Temp5	Temp4
--------	--------	-------	-------	-------	-------	-------	-------

Table 19. OUT_TEMP register description

Temp [11:0]	Temperature sensor output data. The value is expressed as two's complement sign. 0 LSB represents T=25 °C ambient.
-------------	--

7.7 STATUS (27h)

Status register (r)

Table 20. Status register

ZYXOR	ZOR	YOR	XOR	ZYXDA	ZDA	YDA	XDA
-------	-----	-----	-----	-------	-----	-----	-----

Table 21. Status register description

ZYXOR	Logic OR of the single X-, Y- and Z-axis data overrun. Default value: 0 (0: no overrun has occurred; 1: a new set of data has overwritten the previous set)
ZOR	Z-axis data overrun. Default value: 0 (0: no overrun has occurred; 1: new data for the Z-axis has overwritten the previous data)
YOR	Y-axis data overrun. Default value: 0 (0: no overrun has occurred; 1: new data for the Y-axis has overwritten the previous data)
XOR	X-axis data overrun. Default value: 0 (0: no overrun has occurred; 1: new data for the X-axis has overwritten the previous data)
ZYXDA	Logic AND of the single X-, Y- and Z-axis new data available. Default value: 0 (0: a new set of data is not yet available; 1: a new set of data is available)
ZDA	Z-axis new data available. Default value: 0 (0: new data for the Z-axis is not yet available; 1: new data for the Z-axis is available)
YDA	Y-axis new data available. Default value: 0 (0: new data for the Y-axis is not yet available; 1: new data for the Y-axis is available)
XDA	X-axis new data available. Default value: 0 (0: new data for the X-axis is not yet available; 1: new data for the X-axis is available)

7.8 OUT_X (28h - 29h)

Linear acceleration sensor X-axis output register. The value is expressed as a 16-bit word in two's complement.

7.9 OUT_Y (2Ah - 2Bh)

Linear acceleration sensor Y-axis output register. The value is expressed as a 16-bit word in two's complement.

7.10 OUT_Z (2Ch - 2Dh)

Linear acceleration sensor Z-axis output register. The value is expressed as a 16-bit word in two's complement.

7.11 FIFO_CTRL (2Eh)

FIFO control register

Table 22. FIFO_CTRL register

FMODE2	FMODE1	FMODE0	FTH4	FTH3	FTH2	FTH1	FTH0
--------	--------	--------	------	------	------	------	------

Table 23. FIFO_CTRL register description

FMODE [2:0]	FIFO mode selection bits. Default value: 000 For further details refer to Table 24. FIFO mode selection .
FTH [4:0]	FIFO threshold level setting. Default value: 0 0000

Table 24. FIFO mode selection

FMODE2	FMODE1	FMODE0	Mode
0	0	0	Bypass mode. FIFO turned off
0	0	1	FIFO mode. Stops collecting data when FIFO is full.
0	1	0	Reserved
0	1	1	Continuous mode until trigger is asserted, then FIFO mode.
1	0	0	Bypass mode until trigger is asserted, then Continuous mode.
1	0	1	Reserved
1	1	0	Continuous mode. If the FIFO is full, the new sample overwrites the older sample.
1	1	1	Reserved

7.12 FIFO_SRC (2Fh)

FIFO status register

Table 25. FIFO_SRC register

FTH	OVRN	FSS5	FSS4	FSS3	FSS2	FSS1	FSS0
FTH	FIFO threshold status. (0: FIFO filling is lower than threshold level; 1: FIFO filling is equal to or higher than the threshold level)						
OVRN	FIFO overrun status. (0: FIFO is not completely filled; 1: FIFO is completely filled and at least one sample has been overwritten) For further details refer to Table 26. FIFO_SRC example: OVR/FSS details.						
FSS [5:0]	Number of unread samples stored in FIFO. (000000: FIFO empty; 100000: FIFO full, 32 unread samples) For further details refer to Table 26. FIFO_SRC example: OVR/FSS details.						

Table 26. FIFO_SRC example: OVR/FSS details

FTH	OVRN	FSS5	FSS4	FSS3	FSS2	FSS1	FSS0	Description
0	0	0	0	0	0	0	0	FIFO empty
-- ⁽¹⁾	0	0	0	0	0	0	1	1 unread sample
...								
-- ⁽¹⁾	0	1	0	0	0	0	0	32 unread samples
0 ⁽¹⁾	1	1	0	0	0	0	0	At least one sample has been overwritten

1. When the number of unread samples in FIFO is equal to or greater than the threshold level set in register *FIFO_CTRL* (2Eh), the FTH value is '1'.

The FSS is the FIFO stored data level of the unread samples. When it is equal to FTH, all data available in FIFO are read without additional read operations.

The INT output is high when the number of samples to read is equal to or greater than FTH.

Figure 16. Continuous mode: FTH/FSS details

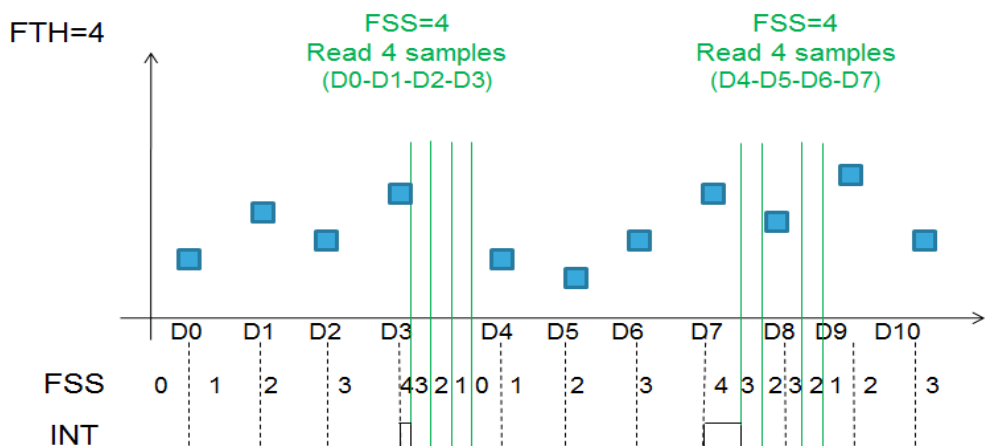

8 Package information

In order to meet environmental requirements, ST offers these devices in different grades of **ECOPACK** packages, depending on their level of environmental compliance. ECOPACK specifications, grade definitions and product status are available at: www.st.com. ECOPACK is an ST trademark.

8.1 LGA-16 package information

The IIS3DHHHC is available in a high-performance (low-stress) ceramic cavity land grid array (CC LGA) package. Due to the use of epoxy glue for lid sealing, hermeticity is not guaranteed. Processing or use of this package in a harsh environment should be assessed by the customer.

Figure 17. Ceramic cavity LGA-16: package outline and mechanical data

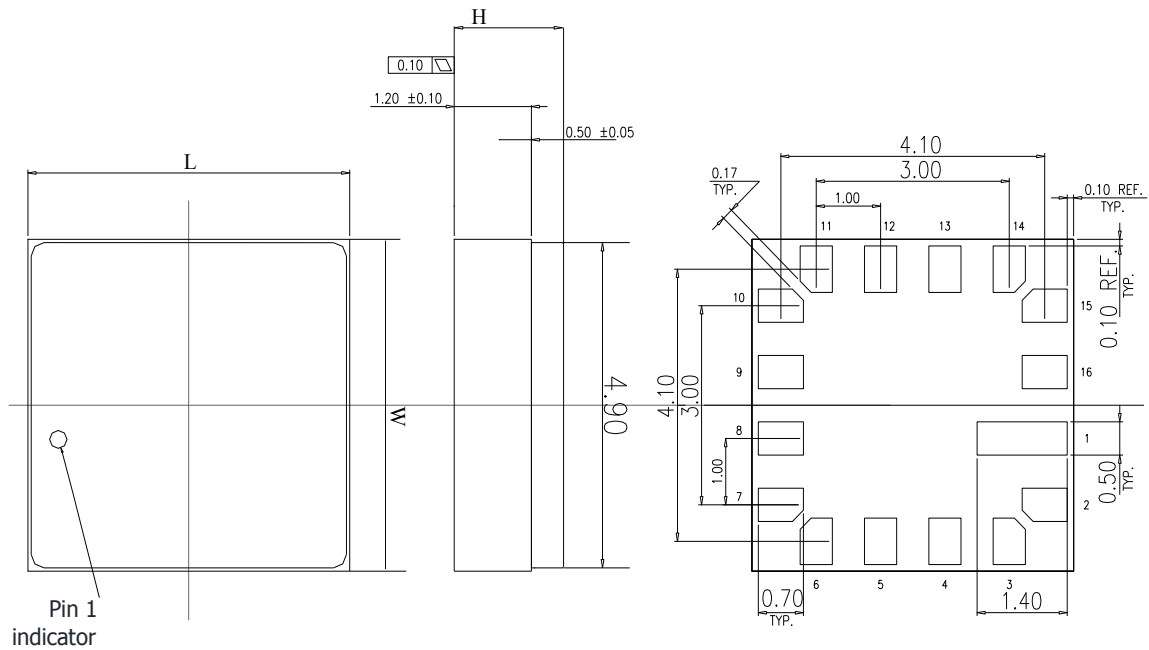

8535893_A

Note: Top and bottom view: dimensions are expressed in mm

Table 27. Outer dimensions

ITEM	Dimension [mm]	Tolerance [mm]
Length [L]	5	±0.15
Width [W]	5	±0.15
Height [H]	1.7 typ	±0.15
Pad size	0.7 x 0.5	±0.15

Note: General tolerance is ±0.1 mm unless otherwise specified

Revision history

Table 28. Document revision history

Date	Revision	Changes
02-Oct-2017	1	Initial release
19-Jan-2018	2	Added product label regarding 10-year longevity commitment Updated Figure 2. Recommended power-up sequence
30-Mar-2020	3	Added information concerning package hermeticity to Section 8.1 LGA-16 package information

Contents

1	Pin description	2
2	Mechanical and electrical specifications	3
2.1	Mechanical characteristics	3
2.2	Electrical characteristics	4
2.2.1	Recommended power-up sequence	4
2.3	Temperature sensor characteristics	5
3	Absolute maximum ratings	6
4	Communication interface characteristics	7
4.1	SPI - serial peripheral interface	7
4.2	SPI bus interface	8
4.2.1	SPI read	9
4.2.2	SPI write	10
5	FIFO	11
5.1	Bypass mode	11
5.2	FIFO mode	12
5.3	Continuous mode	13
5.4	Continuous-to-FIFO mode	14
5.5	Bypass-to-Continuous mode	15
6	Register mapping	16
7	Register description	17
7.1	CTRL_REG1 (20h)	17
7.2	INT1_CTRL (21h)	18
7.3	INT2_CTRL (22h)	19
7.4	CTRL_REG4 (23h)	19
7.5	CTRL_REG5 (24h)	20
7.6	OUT_TEMP_L (25h), OUT_TEMP_H (26h)	20
7.7	STATUS (27h)	21
7.8	OUT_X (28h - 29h)	21
7.9	OUT_Y (2Ah - 2Bh)	21

7.10	OUT_Z (2Ch - 2Dh)	21
7.11	FIFO_CTRL (2Eh)	22
7.12	FIFO_SRC (2Fh)	23
8	Package information	24
8.1	LGA-16 package information	24
	Revision history	25

List of tables

Table 1.	Pin description	2
Table 2.	Mechanical characteristics	3
Table 3.	Electrical characteristics	4
Table 4.	Temperature sensor characteristics	5
Table 5.	Absolute maximum ratings	6
Table 6.	SPI slave timing values.	7
Table 7.	Register mapping.	16
Table 8.	CTRL_REG1 register	17
Table 9.	CTRL_REG1 register description	17
Table 10.	INT1_CTRL register	18
Table 11.	INT2_CTRL register	19
Table 12.	CTRL_REG4 register	19
Table 13.	CTRL_REG4 register description	19
Table 14.	Self-test mode selection	20
Table 15.	CTRL_REG5 register	20
Table 16.	CTRL_REG5 register description	20
Table 17.	OUT_TEMP_L register	20
Table 18.	OUT_TEMP_H register.	20
Table 19.	OUT_TEMP register description.	20
Table 20.	Status register	21
Table 21.	Status register description.	21
Table 22.	FIFO_CTRL register.	22
Table 23.	FIFO_CTRL register description.	22
Table 24.	FIFO mode selection	22
Table 25.	FIFO_SRC register	23
Table 26.	FIFO_SRC example: OVR/FSS details	23
Table 27.	Outer dimensions.	24
Table 28.	Document revision history	25

List of figures

Figure 1.	Pin connections	2
Figure 2.	Recommended power-up sequence	4
Figure 3.	SPI slave timing diagram	7
Figure 4.	Read and write protocol	8
Figure 5.	SPI read protocol	9
Figure 6.	Multiple byte SPI read protocol (2-byte example).	9
Figure 7.	SPI write protocol	10
Figure 8.	Multiple byte SPI write protocol (2-byte example)	10
Figure 9.	Bypass mode	11
Figure 10.	FIFO mode	12
Figure 11.	Continuous mode	13
Figure 12.	Continuous-to-FIFO mode	14
Figure 13.	External asynchronous trigger to FIFO for Continuous-to-FIFO mode	14
Figure 14.	Bypass-to-Continuous mode	15
Figure 15.	External asynchronous trigger to FIFO for Bypass-to-Continuous mode	15
Figure 16.	Continuous mode: FTH/FSS details.	23
Figure 17.	Ceramic cavity LGA-16: package outline and mechanical data	24

IMPORTANT NOTICE – PLEASE READ CAREFULLY

STMicroelectronics NV and its subsidiaries (“ST”) reserve the right to make changes, corrections, enhancements, modifications, and improvements to ST products and/or to this document at any time without notice. Purchasers should obtain the latest relevant information on ST products before placing orders. ST products are sold pursuant to ST’s terms and conditions of sale in place at the time of order acknowledgement.

Purchasers are solely responsible for the choice, selection, and use of ST products and ST assumes no liability for application assistance or the design of Purchasers’ products.

No license, express or implied, to any intellectual property right is granted by ST herein.

Resale of ST products with provisions different from the information set forth herein shall void any warranty granted by ST for such product.

ST and the ST logo are trademarks of ST. For additional information about ST trademarks, please refer to www.st.com/trademarks. All other product or service names are the property of their respective owners.

Information in this document supersedes and replaces information previously supplied in any prior versions of this document.

© 2020 STMicroelectronics – All rights reserved

X-ON Electronics

Largest Supplier of Electrical and Electronic Components

Click to view similar products for [Accelerometers](#) category:

Click to view products by [STMicroelectronics](#) manufacturer:

Other Similar products are found below :

[AD22372Z-RL7](#) [ADXL313WACPZ-RL](#) [805M1-0050-01](#) [MXC6655XA](#) [MMA7455LT](#) [805M1-0200-01](#) [810M1-0025X](#) [832M1-0200](#)
[AIS328DQTR](#) [832M1-0050](#) [805-0050](#) [AD22301](#) [BMA253](#) [ADXL354BEZ](#) [SCA620-EF8H1A-1](#) [MC3413](#) [MXC6244AU](#) [3038-0500](#) [ACH-](#)
[01-04/10](#) [4692](#) [ADXL372BCCZ-RL7](#) [735T](#) [787-500](#) [787AM8](#) [793-6](#) [793L](#) [997-M4](#) [HV101](#) [HV102](#) [HV200](#) [PC420VP-50](#) [PC420VR-10](#)
[786A](#) [786A-IS](#) [787A](#) [787A-IS](#) [HT786A](#) [HT787A](#) [PC420VP-10](#) [ADCMXL1021-1BMLZ](#) [ADIS16003CCCZ](#) [ADIS16006CCCZ](#)
[ADIS16228CMLZ](#) [ADXL700WBRWZ-RL](#) [ADXL1003BCPZ](#) [ADXL103CE-REEL](#) [ADXL203CE-REEL](#) [ADXL206HDZ](#) [ADXL213AE](#)
[ADXL213AE-REEL](#)