

# High-performance MEMS microphone with extended frequency response up to 80 kHz for ultrasound applications

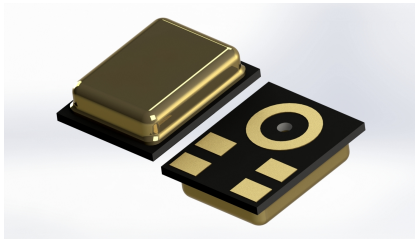

RHLGA metal cap 5-lead  
3.5 x 2.65 x 0.98 mm

## Features

- Single supply voltage operation 1.52 V - 3.6 V
- Omnidirectional sensitivity
- High signal-to-noise ratio
- High acoustic overload point: 130 dB SPL typ.
- Package compliant with reflow soldering
- Enhanced RF immunity
- Ultra-flat frequency response
- Ultrasound bandwidth (up to 80 kHz)
- Low latency
- Ultra-low-power: 150  $\mu$ A max.
- ECOPACK, RoHS, and "Green" compliant

## Applications

- Condition monitoring of industrial equipment
- Leak detection
- Electrical arcing
- Smart medical instruments
- Wearable devices
- Hearables
- Smart speakers
- Active noise-canceling headsets

## Description

The **IMP23ABSU** is a compact, low-power microphone built with a capacitive sensing element and an IC interface.

The sensing element, capable of detecting acoustic waves, is manufactured using a specialized silicon micromachining process to produce audio sensors.

The **IMP23ABSU** has an acoustic overload point of 130 dB SPL with a typical 64 dB signal-to-noise ratio.

The sensitivity of the **IMP23ABSU** is -38 dBV  $\pm$ 1 dB @ 94 dB SPL, 1 kHz.

The **IMP23ABSU** is available in a package compliant with reflow soldering and is guaranteed to operate over an extended temperature range from -40 °C to +85 °C.

Product status link		
IMP23ABSU		
Product summary		
Order code	IMP23ABSU	IMP23ABSUTR
Temp. range [°C]	-40 to +85	
Package	(3.5 x 2.65 x 0.98) mm	
Packing	Tray	Tape and reel
Product label		
		

## 1 Pin description

Figure 1. Pin connections (bottom view)

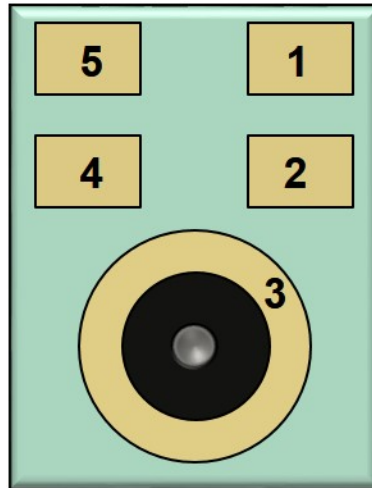

Table 1. Pin description

Pin number	Pin name	Function
1	Out	Output
2	GND	GND
3	GND	GND
4	GND	GND
5	Vdd	Supply voltage

## 2 Acoustic and electrical specifications

### 2.1 Acoustic and electrical characteristics

The values listed in the table below are specified for  $V_{dd} = 2.75\text{ V}$ , no load,  $T_{amb} = 25\text{ °C}$  unless otherwise specified.

**Table 2. Acoustic and electrical characteristics**

Symbol	Parameter	Test condition	Min.	Typ.	Max.	Unit
Vdd	Supply voltage		1.52	2.75	3.6	V
Idd	Current consumption			120	150	μA
So	Sensitivity	1 kHz @ 94 dB SPL	-39	-38	-37	dBV
SNR	Signal-to-noise ratio			64		dB(A)
PSRR	Power supply rejection	100 mVpp sine wave, 1 kHz, $V_{dd} > 1.6\text{ V}$		60		dB
AOP	Acoustic overload point			130		dB SPL
Rload	Load resistance <sup>(1)</sup>		15			kΩ
Top	Operating temperature range		-40		+85	°C

1. *Guaranteed by design*

## 2.2 Frequency response

Figure 2. Typical free-field frequency response normalized at 1 kHz

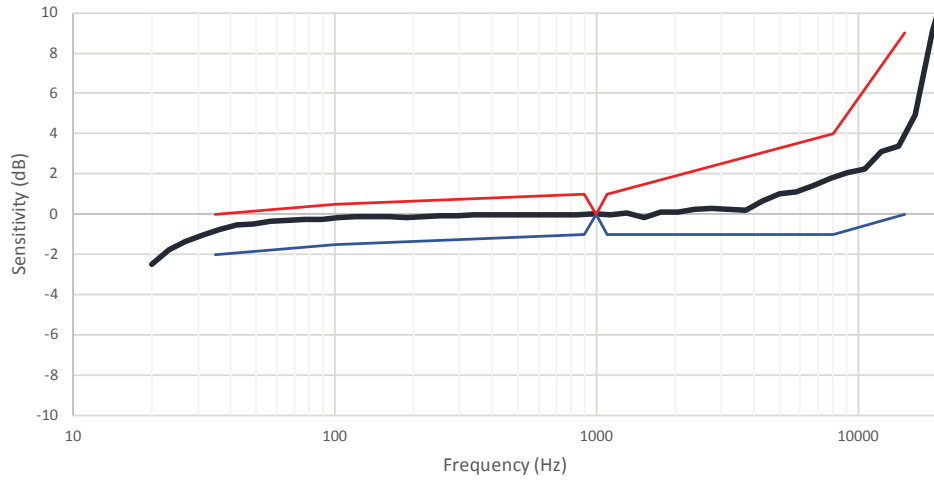
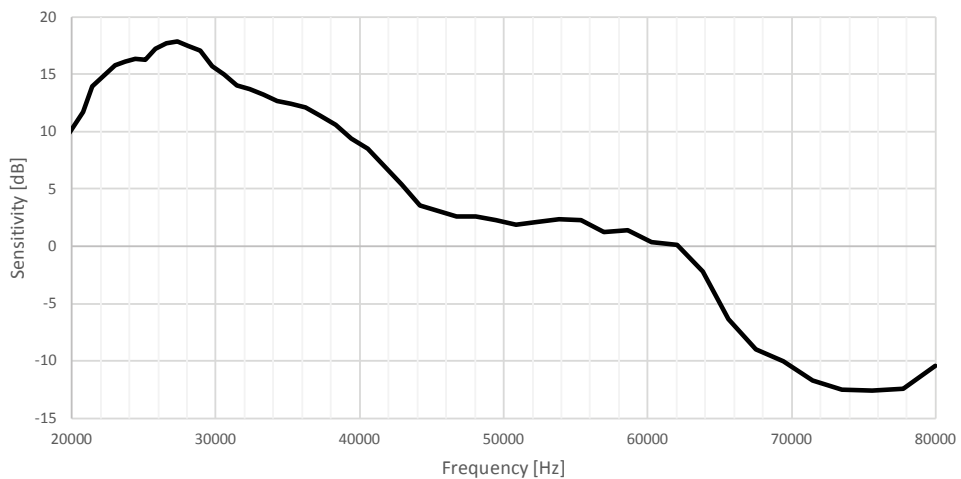

Table 3. Frequency response mask

Frequency (Hz)	LSL	USL	Unit
35	-2	0	dBr 1kHz
100	-1.5	0.5	dBr 1kHz
900	-1	1	dBr 1kHz
1000	0	0	dBr 1kHz
1100	-1	1	dBr 1kHz
8000	-1	4	dBr 1kHz
15000	0	9	dBr 1kHz

Figure 3. Typical ultrasonic free-field response normalized to 1 kHz



### 3 Absolute maximum ratings

Stresses above those listed as “Absolute maximum ratings” may cause permanent damage to the device. This is a stress rating only and functional operation of the device under these conditions is not implied. Exposure to maximum rating conditions for extended periods may affect device reliability.

**Table 4. Absolute maximum ratings**

Symbol	Ratings	Maximum value	Unit
V <sub>DD</sub>	Supply voltage	-0.5 to 4.8	V
T <sub>STG</sub>	Storage temperature range	-40 to +125	°C



This device is sensitive to mechanical shock, improper handling can cause permanent damage to the part.



This device is sensitive to electrostatic discharge (ESD), improper handling can cause permanent damage to the part.

## 4 Application recommendations

### 4.1 IMP23ABSU schematic hints

Figure 4. IMP23ABSU electrical connections and external component values

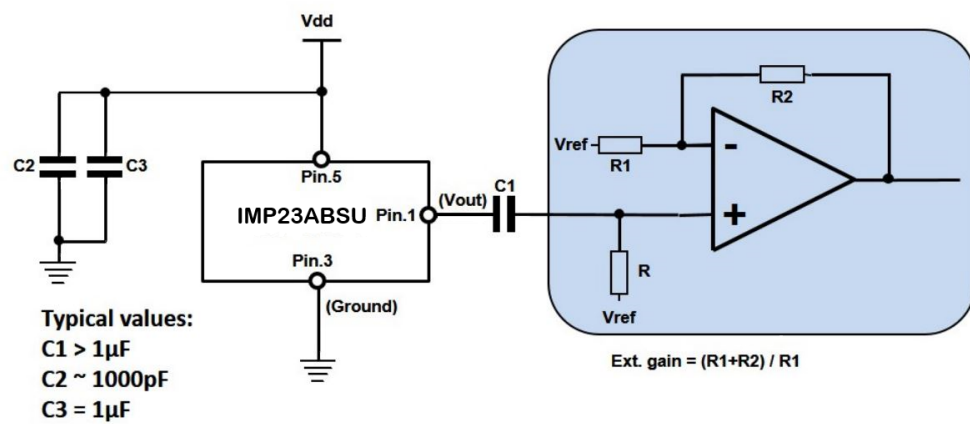

## 5 Soldering information

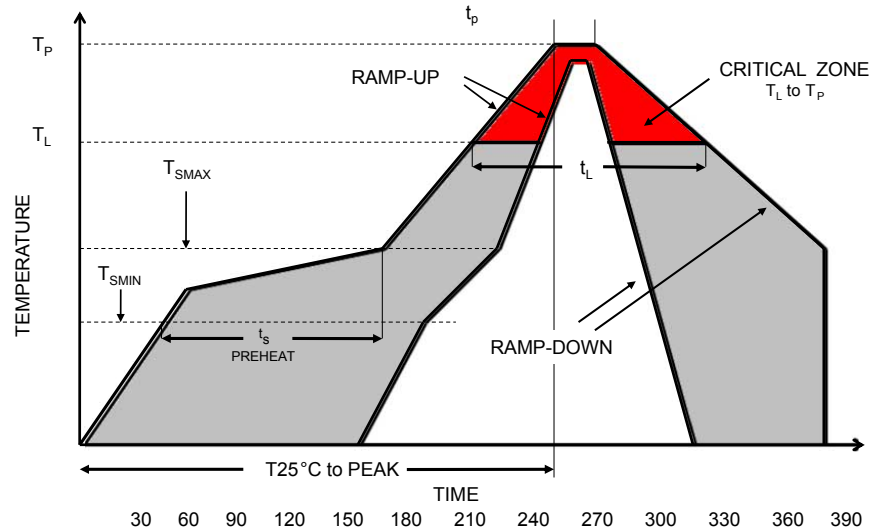
**Figure 5. Recommended soldering profile limits**

**Table 5. Recommended soldering profile limits**

Description	Parameter	Pb free
Average ramp rate	$T_L$ to $T_P$	3 °C/sec max
Preheat		
Minimum temperature	$T_{SMIN}$	150 °C
Maximum temperature	$T_{SMAX}$	200 °C
Time ( $T_{SMIN}$ to $T_{SMAX}$ )	$t_s$	60 sec to 120 sec
Ramp-up rate	$T_{SMAX}$ to $T_L$	
Time maintained above liquidus temperature	$t_L$	60 sec to 150 sec
Liquidus temperature	$T_L$	217 °C
Peak temperature	$T_P$	260 °C max
Time within 5 °C of actual peak temperature		20 sec to 40 sec
Ramp-down rate		6 °C/sec max
Time 25 °C ( $t_{25\text{ °C}}$ ) to peak temperature		8 minutes max

## 6 Reliability tests

**Table 6. Reliability specifications**

Test name	Description	Conditions
Electrostatic Discharge Immunity Test (ESD)	To classify ESD susceptibility the device is submitted to a high voltage peak on all his pins, simulating ESD stress according to different simulation models (GUN, HBM, MM, CDM)	ESD-GUN: 25 discharges at $\pm 8$ kV, direct contact to housing of MIC Reference specification IEC 61000-4-2
		ESD-HBM 3 discharges up to $\pm 2$ kV pin-to-pin Reference specification ANSI/ESDA/JEDEC JS001
		ESD-MM, 3 discharges up to $\pm 200$ V pin-to-pin Reference specification JEDEC JESD22-A115C
		ESD-CDM, 3 discharges up to $\pm 750$ V Reference specification ANSI/ESDA/JEDEC JS002
Latch-Up (LU)	To verify latch-up immunity the device is submitted to a current injection on I/O or supply overvoltage	$\pm 100$ mA & $1.5 \times V_{dd}$ @ $85^\circ\text{C}$ Reference specification JEDEC JESD78
High Temperature Operative Life (HTOL)	To simulate the worst-case application stress conditions, the device is stressed in dynamic configuration at operative max. absolute ratings	Ta $125^\circ\text{C}$ , Tj $125^\circ\text{C}$ , 1000 Hrs, @ Max Op Voltage Preconditioning (PC) before Reference specification JESD22-A108
Temperature Humidity Bias (THB)	To investigate failure mechanisms activated by electrical field and humidity, the device is biased in static or dynamic operative conditions at controlled high temperature and relative humidity	Ta $85^\circ\text{C}$ , R.H. 85%, 1000 Hrs, @ Max Op Voltage Preconditioning (PC) before Reference specification JESD22-A101
Preconditioning MSL3 (PC)	To investigate effects of customer manufacturing soldering enhanced by package water absorption, the device is submitted to typical temperature profile after controlled moisture absorption	MSL3 as moisture soak conditions followed by n.3 reflow @ Tpeak $260^\circ\text{C}$ Reference specification JEDEC J-STD-020
Low Temperature Storage (LTS)	To investigate the failure mechanisms activated by extremely cold conditions, the device is stored in unbiased condition at the min. temperature allowed by the package materials	Ta = $-40^\circ\text{C}$ , 1000 Hrs Reference specification JESD22-A120
High Temperature Storage (HTS)	To investigate the failure mechanisms activated by high temperature, the device is stored in unbiased condition at the maximum temperature allowed by the package materials	Ta = $125^\circ\text{C}$ , 1000 Hrs Reference specification JESD22-A104
Temperature Cycling (TC)	To investigate failure modes related to thermo-mechanical stress, the device is submitted to cycled temperature excursions, between a hot and a cold chamber in air atmosphere	Low T = $-40^\circ\text{C}$ , High T = $+125^\circ\text{C}$ , 1000 Cys Preconditioning (PC) before Reference specification JESD22-A105
Temperature Humidity Storage (THS)	To investigate degradations induced by wet conditions, the device is stored at controlled high temperature and relative humidity	Ta = $85^\circ\text{C}$ , R.H. = 85%, 1000Hrs Preconditioning (PC) before Reference specification JESD22-A102



Test name	Description	Conditions
Random Free-Fall on PCB (TUMBLE)	To investigate durability to mechanical repeated drops without any preferential impact direction simulating drop effect on handheld devices	Microphone soldered on PCB which is mounted on a specific jig Random drop from 1 mt on steel base, 300 drops Reference specification IEC 60068-2-32
Guided Free-Fall on PCB (GFF)	To verify durability of the whole device to mechanical shocks, done by controlling height and impact direction simulating drop effect on handheld devices	Microphone soldered on PCB which is mounted on a specific jig Guided drop from 1.5 mt on marble base, 2 drops x 6 directions Reference specification IEC 60068-2-32
Compressed Air Test (CAT)	Test dedicated on the MEMS Microphone to check mechanical robustness of sensor membrane alone	Microphone membrane is subjected to repeated air pulses controlled on duration, rise and fall time and amplitude. Amplitude is varied with increasing steps. ST internal specification
Mechanical Shock (MS)	To verify mechanical robustness of internal structural elements (MEMS, package components) to withstand severe shocks produced by handling, transportation or field operations	Five pulses of 10,000 g in each of six directions with duration time 0.2 ms Reference specification MIL 883, Method 2002.5
Variable Frequency Vibration (VB)	The vibration variable frequency test is performed to determine the effect of vibration, within a specified frequency range, on the internal structural elements	Peak acceleration of 20 g, from 20 Hz to 2000 Hz in three perpendicular directions Reference specification MIL 883, Method 2007.3-A

## 7 Package information

In order to meet environmental requirements, ST offers these devices in different grades of **ECOPACK** packages, depending on their level of environmental compliance. ECOPACK specifications, grade definitions and product status are available at: [www.st.com](http://www.st.com). ECOPACK is an ST trademark.

### 7.1 RHLGA-5L package information

**Figure 6. RHLGA metal cap 5-lead (3.5 x 2.65 x 0.98 mm) package outline and mechanical data**

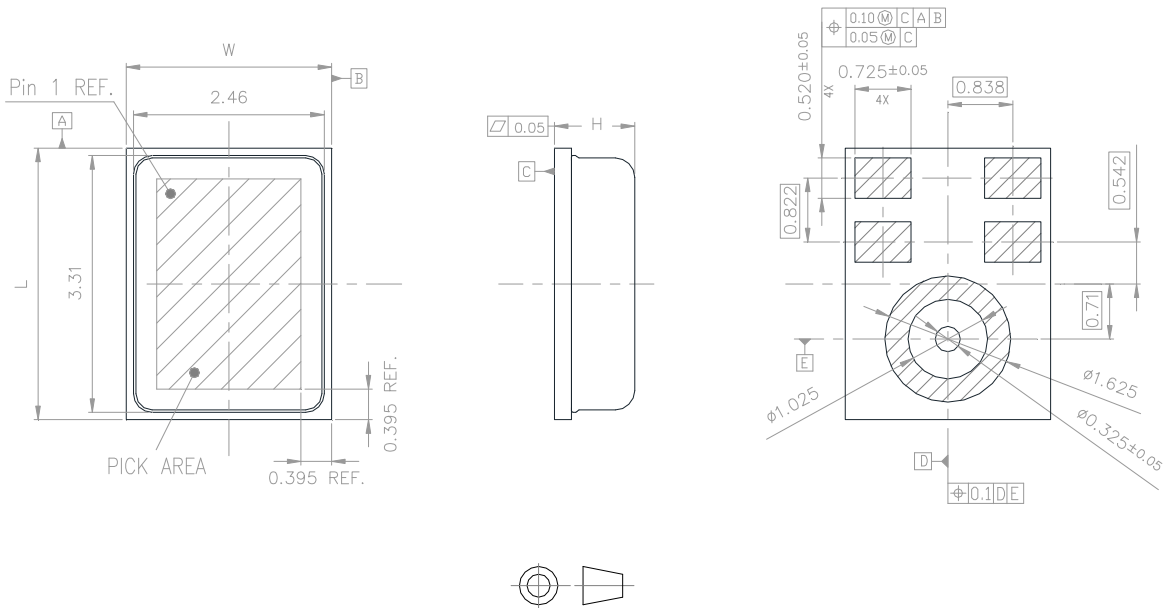

Dimensions are in millimeter unless otherwise specified  
General Tolerance is +/-0.15mm unless otherwise specified

#### OUTER DIMENSIONS

ITEM	DIMENSION [mm]	TOLERANCE [mm]
Length [L]	3.5	±0.1
Width [W]	2.65	±0.1
Height [H]	1.08 MAX	

DM00368430\_2

## 7.2 Land pattern

Figure 7. Land pattern and recommended stencil opening

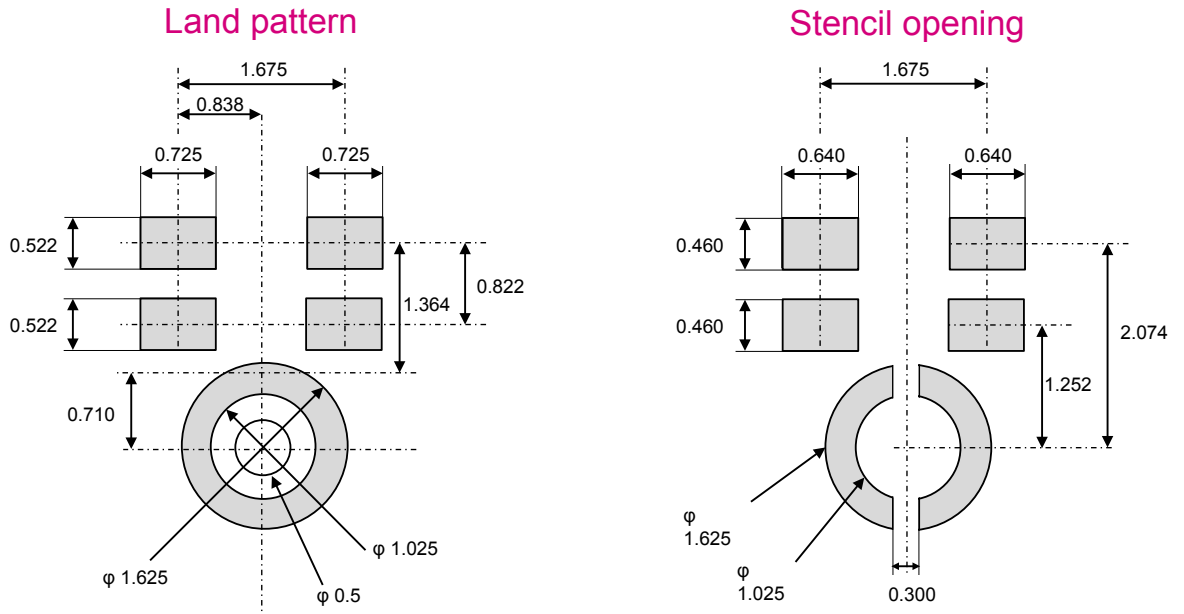

### 7.3 RHLGA-5L packing information

Figure 8. Carrier tape information for RHLGA-5L package

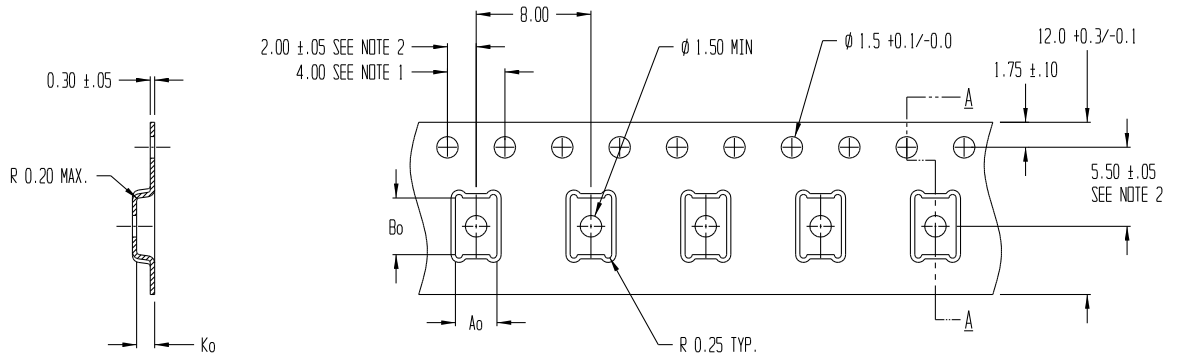

SECTION A - A

$A_0 = 2.89$   
 $B_0 = 3.95$   
 $K_0 = 1.25$

NOTES:

1. 10 SPROCKET HOLE PITCH CUMULATIVE TOLERANCE  $\pm 0.2$
2. POCKET POSITION RELATIVE TO SPROCKET HOLE MEASURED AS TRUE POSITION OF POCKET, NOT POCKET HOLE
3.  $A_0$  AND  $B_0$  ARE CALCULATED ON A PLANE AT A DISTANCE "R" ABOVE THE BOTTOM OF THE POCKET.

## Revision history

**Table 7. Document revision history**

Date	Version	Changes
31-Aug-2020	1	Initial release
16-Sep-2020	2	Minor textual update

## Contents

<b>1</b>	<b>Pin description</b> .....	<b>2</b>
<b>2</b>	<b>Acoustic and electrical specifications</b> .....	<b>3</b>
<b>2.1</b>	Acoustic and electrical characteristics .....	3
<b>2.2</b>	Frequency response .....	4
<b>3</b>	<b>Absolute maximum ratings</b> .....	<b>5</b>
<b>4</b>	<b>Application recommendations</b> .....	<b>6</b>
<b>4.1</b>	IMP23ABSU schematic hints .....	6
<b>5</b>	<b>Soldering information</b> .....	<b>7</b>
<b>6</b>	<b>Reliability tests</b> .....	<b>8</b>
<b>7</b>	<b>Package information</b> .....	<b>10</b>
<b>7.1</b>	RHLGA-5L package information .....	10
<b>7.2</b>	Land pattern .....	11
<b>7.3</b>	RHLGA-5L packing information .....	12
	<b>Revision history</b> .....	<b>13</b>
	<b>Contents</b> .....	<b>14</b>

**IMPORTANT NOTICE – PLEASE READ CAREFULLY**

STMicroelectronics NV and its subsidiaries (“ST”) reserve the right to make changes, corrections, enhancements, modifications, and improvements to ST products and/or to this document at any time without notice. Purchasers should obtain the latest relevant information on ST products before placing orders. ST products are sold pursuant to ST’s terms and conditions of sale in place at the time of order acknowledgement.

Purchasers are solely responsible for the choice, selection, and use of ST products and ST assumes no liability for application assistance or the design of Purchasers’ products.

No license, express or implied, to any intellectual property right is granted by ST herein.

Resale of ST products with provisions different from the information set forth herein shall void any warranty granted by ST for such product.

ST and the ST logo are trademarks of ST. For additional information about ST trademarks, please refer to [www.st.com/trademarks](http://www.st.com/trademarks). All other product or service names are the property of their respective owners.

Information in this document supersedes and replaces information previously supplied in any prior versions of this document.

© 2020 STMicroelectronics – All rights reserved

## X-ON Electronics

Largest Supplier of Electrical and Electronic Components

*Click to view similar products for [MEMS Microphones](#) category:*

*Click to view products by [STMicroelectronics](#) manufacturer:*

Other Similar products are found below :

[8103AC8333S25.00000X](#) [S-VM2020-C](#) [SPK0838HT4H-1](#) [MMICT4076-00-908](#) [MMICT4078-00-908](#) [ICS-41352](#) [1007079-1](#) [ASFLM1-25.000MHZ-C](#) [5000AC-8E-25E0-25.000000X](#) [ICS-40300](#) [ICS-40618](#) [ICS-43432](#) [3807ACTC3-33EG-8.19200](#) [501AAA27M0000CAF](#) [SIT9120AC-2C2-25E125.000000](#) [SIT9120AC-2C2-25E200.000000](#) [SIT9121AI-2C3-33E100.000000](#) [9120AI-2C3-25E100.0000](#) [MP34DB01TR](#) [8002AI-13-33E16.00000](#) [5001AI-2D-18N0-20.000000](#) [MM042602-4](#) [MM042602-5](#) [MM033802-1](#) [ICS-43434](#) [ASFLM2-28.224MHZ-LR-T](#) [ICS-40310](#) [ICS-40720](#) [9003AC-14-33EQ25.00000](#) [SIT9120AC-2C2-33E125.000000](#) [1618AA-13-33S-16.000000G](#) [PMM-3738-VM1000-R](#) [64-8801](#) [IM69D120V01XTSA1](#) [SPA1687LR5H-1](#) [SPG08P4HM4H-1](#) [SPH0611LR5H-1](#) [SPH0641LM4H-1](#) [SPH0644LM4H-1](#) [SPH0645LM4H-B](#) [SPH0690LM4H-1](#) [SPH1642HT5H-1](#) [SPH1668LM4H-1](#) [SPH6611LR5H-1](#) [SPK0415HM4H-B](#) [SPK0641HT4H-1](#) [SPM0687LR5H-1](#) [SPM1423HM4H-B](#) [SPQ1410HR5H-B](#) [SPU0410HR5H-PB](#)