

High power density 600 V Half bridge driver with two enhancement mode GaNHEMT



Features

- 600 V system-in-package integrating half-bridge gate driver and high-voltage power GaN transistors in asymmetrical configuration:
 - QFN 9 x 9 x 1 mm package
 - $R_{DS(ON)} = 225 \text{ m}\Omega \text{ (LS)} + 450 \text{ m}\Omega \text{ (HS)}$
 - $I_{DS(MAX)} = 6.5 \text{ A (LS)} + 4 \text{ A (HS)}$
- Reverse current capability
- Zero reverse recovery loss
- UVLO protection on low-side and high-side
- Internal bootstrap diode
- Interlocking function
- Dedicated pin for shutdown functionality
- Accurate internal timing match
- 3.3 V to 15 V compatible inputs with hysteresis and pull-down
- Overtemperature protection
- Bill of material reduction
- Very compact and simplified layout
- Flexible, easy and fast design.

Application

- Switch-mode power supplies
- Chargers and adapters
- High-voltage PFC, and DC-DC converters

Description

The **MASTERGAN3** is an advanced power system-in-package integrating a gate driver and two enhancement mode GaN transistors in asymmetrical half-bridge configuration.

The integrated power GaNs have 650 V drain-source blocking voltage and $R_{DS(ON)}$ of 225 m Ω and 450 m Ω for Low side and High side respectively, while the high side of the embedded gate driver can be easily supplied by the integrated bootstrap diode, while the high side of the embedded gate driver can be easily supplied by the integrated bootstrap diode.

The **MASTERGAN3** features UVLO protection on both the lower and upper driving sections, preventing the power switches from operating in low efficiency or dangerous conditions, and the interlocking function avoids cross-conduction conditions.

The input pins extended range allows easy interfacing with microcontrollers, DSP units or Hall effect sensors.

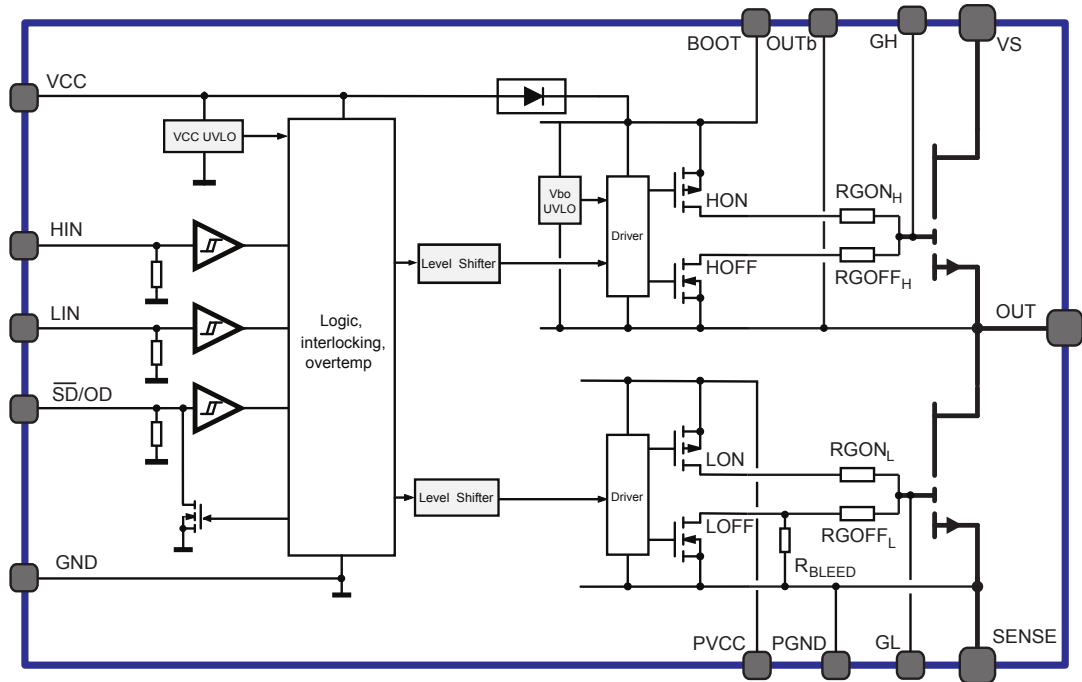
The **MASTERGAN3** operates in the industrial temperature range, -40°C to 125°C.

The device is available in a compact 9x9 mm QFN package.

Product status link
MASTERGAN3
Product label

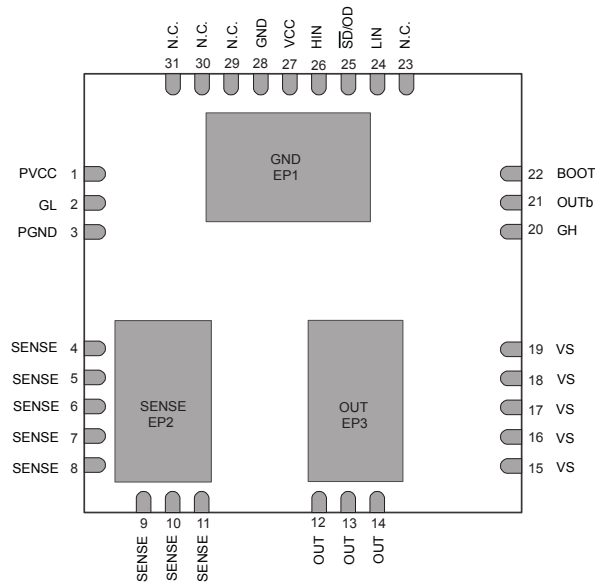

1 Block diagram

Figure 1. MASTERGAN3 block diagram



2 Pin description and connection diagram

Figure 2. Pin connection (top view)



2.1 Pin list

Table 1. Pin description

Pin Number	Pin Name	Type	Function
15, 16, 17, 18, 19	VS	Power Supply	High voltage supply (high-side GaN Drain)
12, 13, 14, EP3	OUT	Power Output	Half-bridge output
4, 5, 6, 7, 8, 9, 10, 11, EP2	SENSE	Power Supply	Half-bridge sense (low-side GaN Source)
22	BOOT	Power Supply	Gate driver high-side supply voltage
21	OUTb	Power Supply	Gate driver high-side reference voltage, used only for Bootstrap capacitor connection. Internally connected to OUT.
27	VCC	Power Supply	Logic supply voltage
1	PVCC	Power Supply	Gate driver low-side supply voltage
28, EP1	GND	Power Supply	Gate driver ground
3	PGND	Power Supply	Gate driver low-side buffer ground. Internally connected to SENSE
26	HIN	Logic Input	High-Side driver logic input
24	LIN	Logic Input	Low-Side driver logic input
25	SD/OD	Logic Input-Output	Driver Shutdown input and Fault Open-Drain
2	GL	Output	Low-Side GaN gate
20	GH	Output	High-Side GaN gate
23, 29, 30, 31	N.C.	Not Connected	Leave floating

3 Electrical Data

3.1 Absolute maximum ratings

Table 2. Absolute maximum ratings

Each voltage referred to GND unless otherwise specified

Symbol	Parameter	Test Condition	Value	Unit
V _{DS}	GaN Drain-to-Source Voltage	T _J = 25 °C	620	V
VCC	Logic supply voltage		-0.3 to 11	V
PVCC-PGND	Low-side driver supply voltage ⁽¹⁾		-0.3 to 7	V
VCC-PGND	Logic supply vs. Low-side driver ground		-0.3 to 18.3	V
PVCC	Low-side driver supply vs. logic ground		-0.3 to 18.3	V
PGND	Low-side driver ground vs. logic ground		-7.3 to 11.3	V
V _{BO}	BOOT to OUTb voltage ⁽²⁾		-0.3 to 7	V
BOOT	Bootstrap voltage		-0.3 to 620	V
CGL, CGH	Maximum external capacitance between GL and PGND and between GH and OUTb	F _{sw} = 500 kHz ⁽³⁾	3.9	nF
RGL, RGH	Minimum external pull-down resistance between GL and PGND and GH and OUTb		6.8	kΩ
I _D	Drain current (Low side GaN transistor)	DC @ T _{CB} = 25°C ^{(4) (5)}	6.5	A
		DC @ T _{CB} = 100°C ^{(4) (5)}	4.4	A
		Peak @ T _{CB} = 25°C ^{(4) (5) (6)}	12	A
I _D	Drain current (High side GaN transistor)	DC @ T _{CB} = 25°C ^{(4) (5)}	4	A
		DC @ T _{CB} = 100°C ^{(4) (5)}	2.6	A
		Peak @ T _{CB} = 25°C ^{(4) (5) (6)}	7	A
SR _{out}	Half-bridge outputs slew rate (10% - 90%)		100	V/ns
V _i	Logic inputs voltage range		-0.3 to 21	V
T _J	Junction temperature		-40 to 150	°C
T _s	Storage temperature		-40 to 150	°C

1. PGND internally connected to SENSE

2. OUTb internally connected to OUT

 3. $CGx < 0.08 / (Pvcc^2 * Fsw) - (330 * 10^{-12})$

 4. T_{CB} is temperature of case exposed pad.

5. Range estimated by characterization, not tested in production.

6. Value specified by design factor, pulse duration limited to 50 μs and junction temperature.

3.2 Recommended operating conditions

Table 3. Recommended operating conditions

Each voltage referred to GND unless otherwise specified

Symbol	Parameter	Note	Min	Max	Unit
VS	High voltage bus		0	520	V
VCC	Supply voltage		4.75	9.5	V
PVCC-PGND	PVCC to PGND low side supply voltage ⁽¹⁾		4.75	6.5	V
		Best performance	5	6.5	V
PVCC	Low-side driver supply voltage		3	8.5	V
VCC-PVCC	VCC to PVCC pin voltage		-3	3	V
PGND	Low-side driver ground ⁽¹⁾		-2	2	V
DT	Suggested minimum deadtime		5		ns
T _{IN_MIN}	Minimum duration of input pulse to obtain undistorted output pulse		120		ns
V _{BO}	BOOT to OUTb pin voltage ⁽²⁾		4.4	6.5	V
		Best performance	5	6.5	V
BOOT	BOOT to GND voltage		0 ⁽³⁾	530	V
V _i	Logic inputs voltage range		0	20	V
T _J	Junction temperature		-40	125	°C

1. PGND internally connected to SENSE
2. OUTb internally connected to OUT
3. 5 V is recommended during high-side turn-on

3.3 Thermal data

Table 4. Thermal data

Symbol	Parameter	Value	Unit
R _{th(J-CB)_LS}	Thermal resistance Low side junction to SENSE exposed pad, typical	2.8	°C/W
R _{th(J-CB)_HS}	Thermal resistance High side junction to OUT exposed pad, typical	4.7	°C/W
R _{th(J-A)}	Thermal resistance junction-to-ambient ⁽¹⁾	18.8	°C/W

1. The junction to ambient thermal resistance is obtained simulating the device mounted on a 2s2p (4 layer) FR4 board as JESD51-5,7 with 6 thermal vias for each exposed pad. Power dissipation uniformly distributed over the two GaN transistors.

4 Electrical characteristics

4.1 Driver

Table 5. Driver electrical characteristics

VCC = PVCC = 6 V; SENSE = GND; T_J = 25°C, unless otherwise specified (each voltage referred to GND unless otherwise specified)

Symbol		Parameter	Test condition	Min	Typ	Max	Unit
Logic section supply							
VCC _{thON}	VCC vs. GND	VCC UV turn ON threshold ⁽¹⁾		4.2	4.5	4.75	V
VCC _{thOFF}		VCC UV turn OFF threshold ⁽¹⁾		3.9	4.2	4.5	V
VCC _{hys}		VCC UV hysteresis ⁽¹⁾		0.2	0.3	0.45	V
I _{QVCCU}		VCC undervoltage quiescent supply current	VCC = PVCC = 3.8 V		320	410	μA
I _{QVCC}		VCC quiescent supply current	$\overline{SD}/OD = LIN = 5 V$; HIN = 0 V; BOOT = 7 V		680	900	μA
I _{SVCC}		VCC switching supply current	$\overline{SD}/OD = 5 V$; V _{BO} = 6.5 V; VS = 0 V; F _{SW} = 500 kHz		0.8		mA
Low-side driver section supply							
I _{QPCC}	PVCC vs. PGND	PVCC quiescent supply current	$\overline{SD}/OD = LIN = 5 V$		150		μA
I _{SPVCC}		PVCC switching supply current	VS = 0 V F _{SW} = 500 kHz		1		mA
R _{BLEED}	GL vs. PGND	Low side gate bleeder	PVCC = PGND	75	100	125	kΩ
R _{ONL}		Low side turn on resistance ⁽²⁾	I(GL) = 1 mA (source)		77		Ω
R _{OFFL}		Low side turn off resistance ⁽²⁾	I(GL) = 1 mA (sink)		2		Ω
High-side floating section supply							
V _{BOthON}	BOOT vs. OUTb	V _{BO} UV turn ON threshold ⁽³⁾		3.6	4.0	4.4	V
V _{BOthOFF}		V _{BO} UV turn OFF threshold ⁽³⁾		3.4	3.7	4.0	V
V _{BOhys}		V _{BO} UV hysteresis ⁽³⁾		0.1	0.3	0.5	V
I _{QBOU}	BOOT vs. OUTb	V _{BO} undervoltage quiescent supply current ⁽³⁾	V _{BO} = 3.4 V		140	200	μA
I _{QBO}		V _{BO} quiescent supply current ⁽³⁾	V _{BO} = 6 V; LIN = GND; $\overline{SD}/OD = HIN = 5 V$;		180		μA
I _{SBO}	BOOT	BOOT switching supply current	V _{BO} = 6 V; $\overline{SD}/OD = 5 V$; VS = 0 V; F _{SW} = 500 kHz		1.1		mA
I _{LK}	BOOT vs. SGND	High voltage leakage current	BOOT = OUT = 600 V			11	μA
R _{DBoot}	VCC vs. BOOT	Bootstrap diode on resistance ⁽⁴⁾	$\overline{SD}/OD = LIN = 5 V$; HIN = GND = PGND VCC – BOOT = 0.5 V		140	175	Ω
R _{ONH}		High side turn on resistance ⁽²⁾	I(GH) = 1 mA (source)		77		Ω

Symbol		Parameter	Test condition	Min	Typ	Max	Unit
ROFF _H		High side turn off resistance ⁽²⁾	I(GH) = 1 mA (sink)		2		Ω
Logic inputs							
V _{il}	LIN, HIN, \overline{SD}/OD	Low level logic threshold	T _J = 25°C	1.1	1.31	1.45	V
			Full Temperature range ⁽⁵⁾	0.8			
V _{ih}		High level logic threshold	T _J = 25°C	2	2.17	2.5	V
			Full Temperature range ⁽⁵⁾			2.7	
V _{ihys}		Logic input threshold hysteresis		0.7	0.96	1.2	V
I _{INh}		LIN, HIN	Logic '1' input bias current	LIN, HIN = 5 V	23	33	55
I _{INl}	Logic '0' input bias current		LIN, HIN = GND			1	μA
R _{PD_IN}	Input pull-down resistor		LIN, HIN = 5 V	90	150	220	kΩ
I _{SDh}	\overline{SD}/OD	Logic "1" input bias current	\overline{SD}/OD = 5 V	11	15	20	μA
I _{SDl}	\overline{SD}/OD	Logic "0" input bias current	\overline{SD}/OD = 0 V			1	μA
R _{PD_SD}	\overline{SD}/OD	Pull-down resistor	\overline{SD}/OD = 5 V OpenDrain OFF	250	330	450	kΩ
V _{TSD}	\overline{SD}/OD	Thermal shutdown unlatch threshold	T _J = 25°C ⁽⁶⁾	0.5	0.75	1	V
R _{ON_OD}	\overline{SD}/OD	Open drain ON resistance	T _J = 25°C; I _{OD} = 400 mV ⁽⁶⁾	8	10	18	Ω
I _{OL_OD}	\overline{SD}/OD	Open Drain low level sink current	T _J = 25°C; V _{OD} = 400 mV ⁽⁶⁾	22	40	50	mA
T _{d,GL}	LIN, GL	Prop. delay from LIN to GL	⁽⁶⁾		46		ns
T _{d,GH}	HIN, GH	Prop. delay from HIN to GH	⁽⁶⁾		46		ns
Overtemperature protection							
T _{TSD}		Shutdown temperature	⁽⁵⁾		175		°C
T _{HYS}		Temperature hysteresis	⁽⁵⁾		20		°C

1. VCC UVLO is referred to VCC - GND

2. Turn on and turn off total resistances include the values of the gate resistors and the driver R_{dson}

3. V_{BO} = V_{BOOT} - V_{OUT}

4. R_{BD(on)} is tested in the following way:

$$R_{BD(on)} = [(V_{CC} - V_{BOOTa}) - (V_{CC} - V_{BOOTb})] / [I_a - I_b]$$

Where: I_a is BOOT pin current when V_{BOOT} = V_{BOOTa}; I_b is BOOT pin current when V_{BOOT} = V_{BOOTb}

5. Range estimated by characterization, not tested in production.

6. Tested at wafer level.

4.2 GaN power transistor

Table 6. GaN power transistor electrical characteristics
 $V_{GS} = 6\text{ V}$; $T_J = 25^\circ\text{C}$, unless otherwise specified

Symbol	Parameter	Test condition	Min	Typ	Max	Unit
GaN on/off states						
$V_{(BR)DS}$	Drain-source blocking voltage	Low side $I_{DSS} < 13.3\ \mu\text{A}$ ⁽¹⁾ High side $I_{DSS} < 6.6\ \mu\text{A}$ ⁽¹⁾ $V_{GS} = 0\text{ V}$	650			V
I_{DSS_LS}	Zero gate voltage drain current - low side	$V_{DS} = 600\text{ V}$ $V_{GS} = 0\text{ V}$		0.5		μA
I_{DSS_HS}	Zero gate voltage drain current - high side	$V_{DS} = 600\text{ V}$ $V_{GS} = 0\text{ V}$		0.3		μA
$V_{GS(th)}$	Gate threshold voltage	$V_{DS} = V_{GS}$ Low side, $I_D = 2.5\text{ mA}$ ⁽¹⁾ High side, $I_D = 1.7\text{ mA}$ ⁽¹⁾		1.7		V
I_{GS_LS}	Gate to source current - Low side	$V_{DS} = 0\text{ V}$ ⁽²⁾		40		μA
I_{GS_HS}	Gate to source current - High side	$V_{DS} = 0\text{ V}$ ⁽²⁾		20		μA
$R_{DS(on)_LS}$	Static drain-source on-resistance - Low side	$I_D = 2.2\text{ A}$	$T_J = 25^\circ\text{C}$	225	300	m Ω
			$T_J = 125^\circ\text{C}$ ⁽²⁾	495		
$R_{DS(on)_HS}$	Static drain-source on-resistance - High side	$I_D = 1.2\text{ A}$	$T_J = 25^\circ\text{C}$	450	600	m Ω
			$T_J = 125^\circ\text{C}$ ⁽²⁾	1012		

1. Tested at wafer level.
2. Value estimated by characterization, not tested in production.

5 Device characterization values

The information in [Table 7](#) and [Table 8](#) represents typical values based on characterization and simulation results and are not subject to the production test.

Table 7. GaN power transistor characterization values

Symbol	Parameter	Test condition	Min	Typ	Max	Unit	
Q _G	Total gate charge	V _{GS} = 6 V, T _J = 25°C V _{DS} = 0 to 400 V - Low side		1.5		nC	
		V _{GS} = 6 V, T _J = 25°C V _{DS} = 0 to 400 V - High side		0.8		nC	
Q _{OSS}	Output charge - Low side	V _{GS} = 0 V, V _{DS} = 400 V		14		nC	
	Output charge - High side			7		nC	
E _{OSS}	Output capacitance stored energy - Low side			1.7		μJ	
	Output capacitance stored energy - High side			0.9		μJ	
C _{OSS}	Output capacitance - Low side			14.2		pF	
	Output capacitance - High side			7		pF	
C _{O(ER)}	Effective output capacitance energy related - Low side ⁽¹⁾		V _{GS} = 0 V, V _{DS} = 0 to 400 V		21		pF
	Effective output capacitance energy related - High side ⁽¹⁾				11		pF
C _{O(TR)}	Effective output capacitance time related - Low side ⁽²⁾			34		pF	
	Effective output capacitance time related - High side ⁽²⁾			17		pF	
Q _{RR}	Reverse recovery charge			0		nC	
I _{RRM}	Reverse recovery current			0		A	

1. C_{O(ER)} is the fixed capacitance that would give the same stored energy as C_{OSS} while V_{DS} is rising from 0 V to the stated V_{DS}
2. C_{O(TR)} is the fixed capacitance that would give the same charging time as C_{OSS} while V_{DS} is rising from 0 V to the stated V_{DS}

Table 8. Inductive load switching characteristics

Symbol	Parameter	Test condition	Min	Typ	Max	Unit
t _(on) ⁽¹⁾	Turn-on time - Low side	V _S = 400 V, V _{GS} = 6 V, I _{D_LS} = 2.2 A, I _{D_HS} = 1.2 A See Figure 3		70		ns
	Turn-on time - High side			70		ns
t _{C(on)} ⁽²⁾	Crossover time (on) - Low side			15		ns
	Crossover time (on) - High side			25		ns
t _(off) ⁽¹⁾	Turn-off time - Low side			70		ns
	Turn-off time - High side			70		ns
t _{C(off)} ⁽²⁾	Crossover time (off) - Low side			15		ns
	Crossover time (off) - High side			10		ns
t _{SD}	Shutdown to high/low-side propagation delay			70		ns
E _{on}	Turn-on switching losses - Low side			10		μJ
	Turn-on switching losses - High side		4.5		μJ	

Symbol	Parameter	Test condition	Min	Typ	Max	Unit
E_{off}	Turn-off switching losses	$V_S = 400\text{ V}$, $V_{GS} = 6\text{ V}$, $I_{D_LS} = 2.2\text{ A}$, $I_{D_HS} = 1.2\text{ A}$ See Figure 3		2.5		μJ

1. $t_{(on)}$ and $t_{(off)}$ include the propagation delay time of the internal driver
2. $t_{C(on)}$ and $t_{C(off)}$ are the switching times of GaN transistor itself under the internally given gate driving conditions

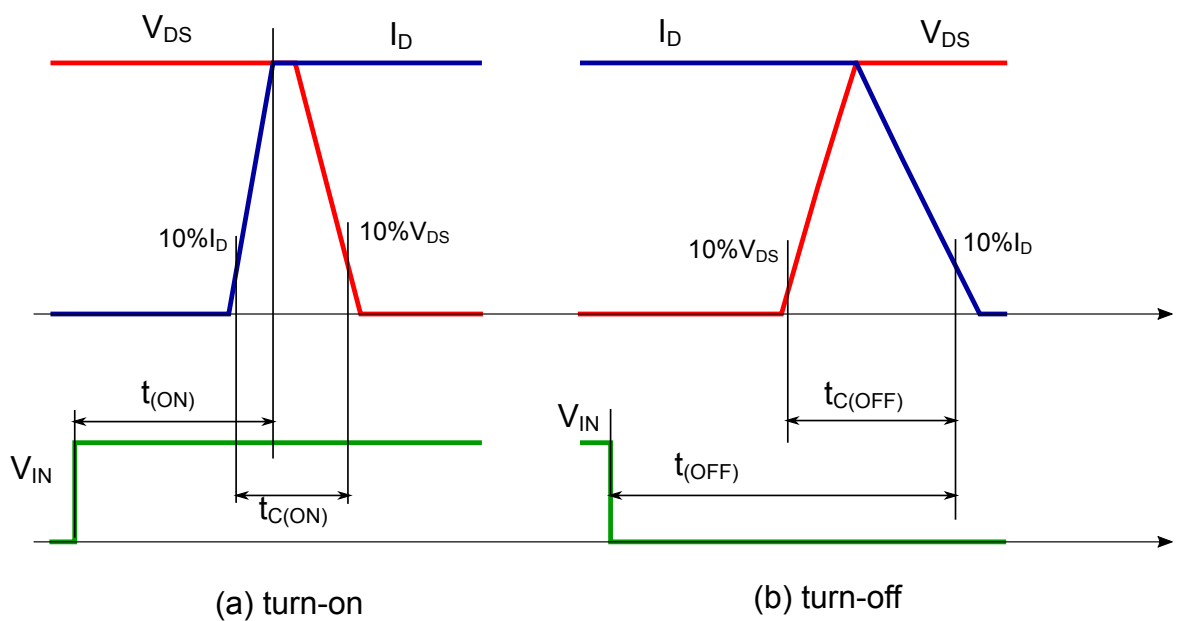
Figure 3. Switching time definition


Figure 4. Typ I_{D_LS} vs. V_{DS} at $T_J=25^\circ\text{C}$

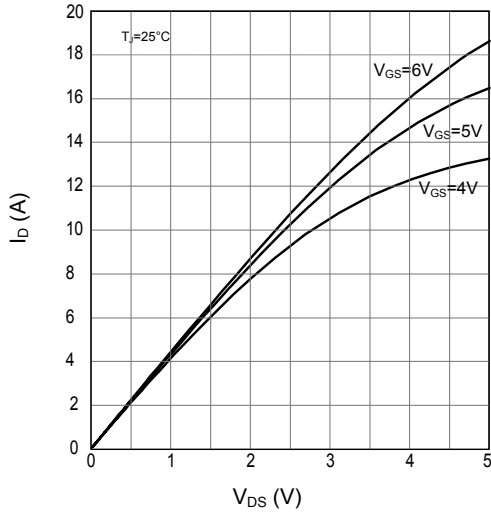


Figure 5. Typ I_{D_LS} vs. V_{DS} at $T_J=125^\circ\text{C}$

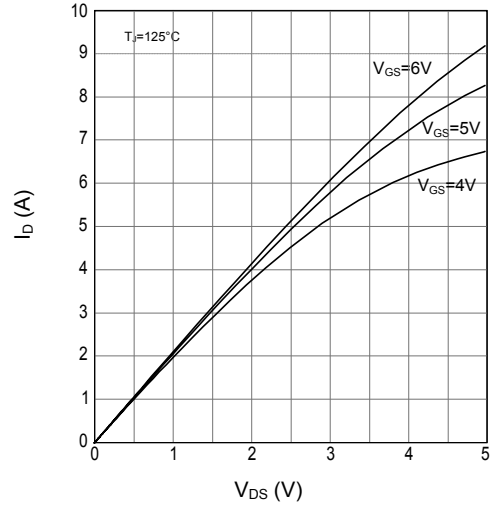


Figure 6. Typ I_{D_HS} vs. V_{DS} at $T_J=25^\circ\text{C}$

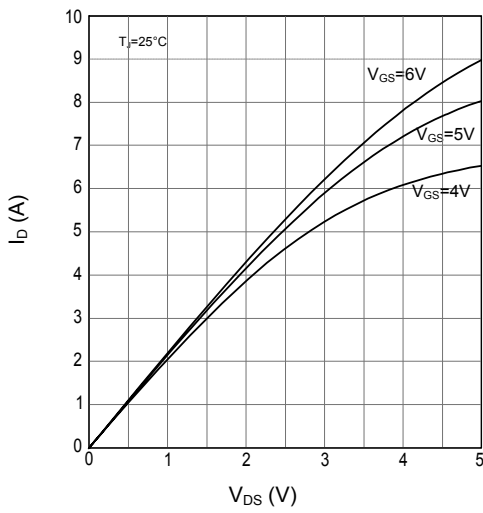


Figure 7. Typ I_{D_HS} vs. V_{DS} at $T_J=125^\circ\text{C}$

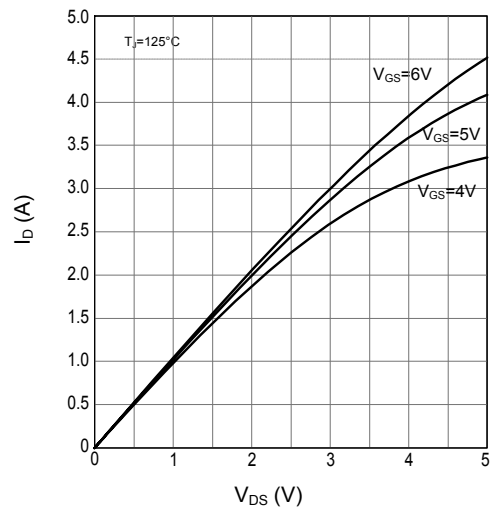


Figure 8. Typ $R_{DS(on)_LS}$ vs. I_D at $T_J=25^\circ\text{C}$

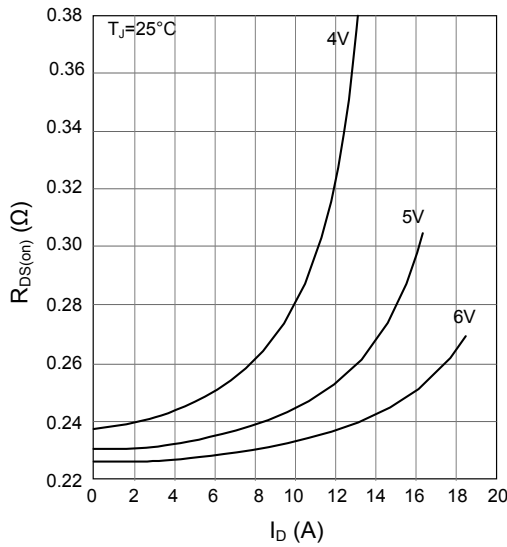


Figure 9. Typ $R_{DS(on)_LS}$ vs. I_D at $T_J=125^\circ\text{C}$

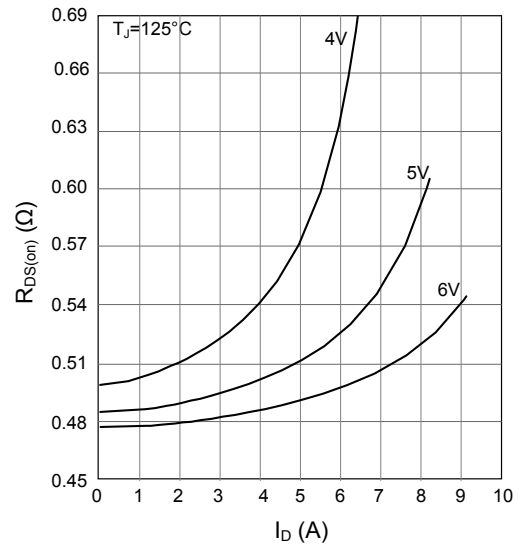


Figure 10. Typ $R_{DS(on)_HS}$ vs. I_D at $T_J=25^\circ\text{C}$

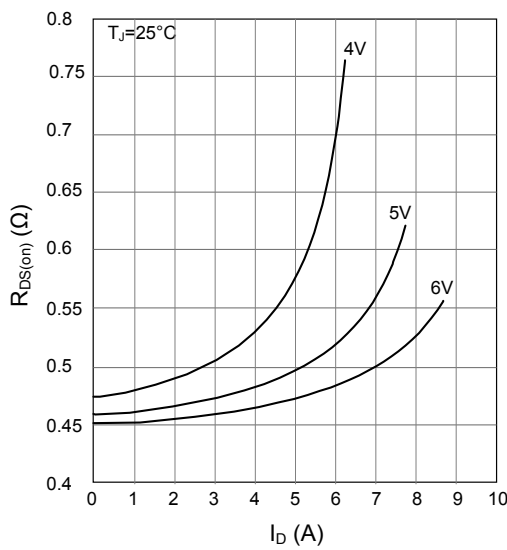


Figure 11. Typ $R_{DS(on)_HS}$ vs. I_D at $T_J=125^\circ\text{C}$

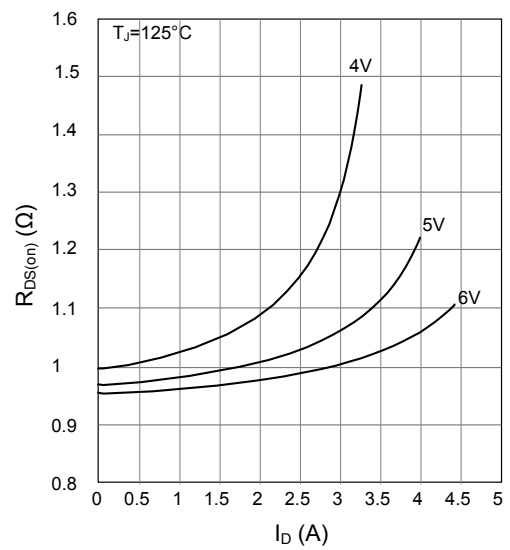


Figure 12. Typ I_{D_LS} vs. V_{DS}

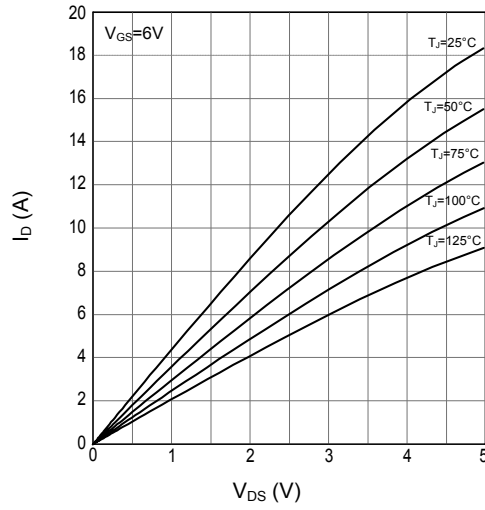


Figure 13. Typ I_{D_HS} vs. V_{DS}

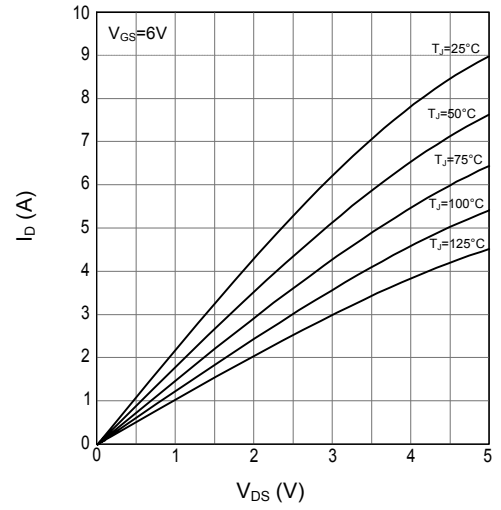


Figure 14. Typ $R_{DS(on)}$ vs. T_J normalized at 25°C

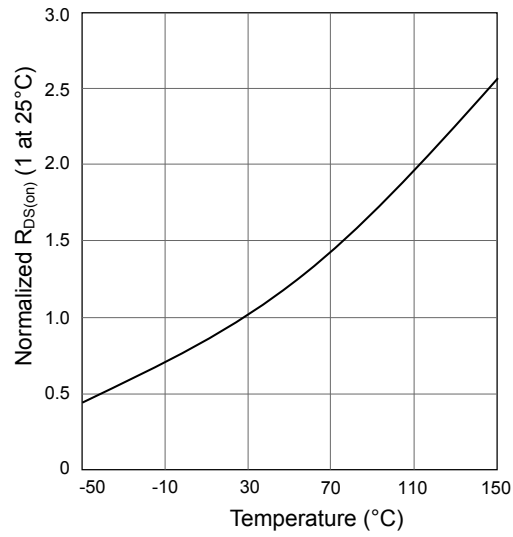


Figure 15. Typ I_{SD_LS} vs. V_{SD_LS} at $T_J=25^\circ\text{C}$

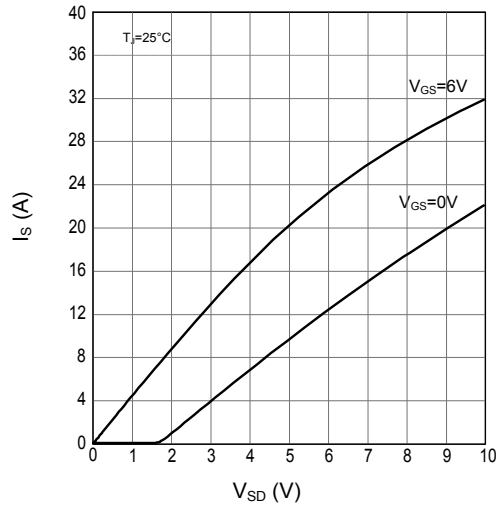


Figure 16. Typ I_{SD_LS} vs. V_{SD_LS} at $T_J=125^\circ\text{C}$

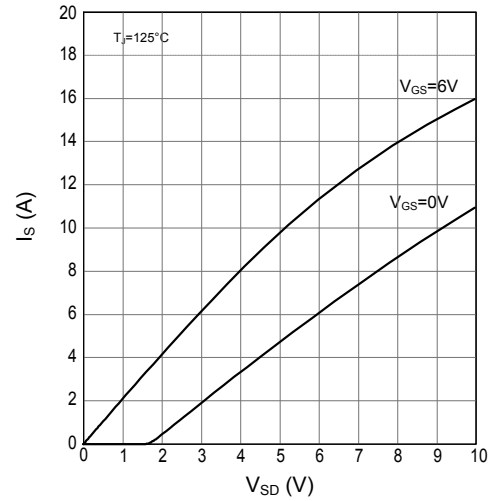


Figure 17. Typ I_{SD_HS} vs. V_{SD_HS} at $T_J=25^\circ\text{C}$

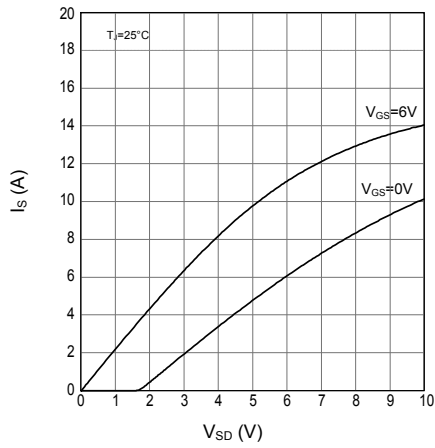


Figure 18. Typ I_{SD_HS} vs. V_{SD_HS} at $T_J=125^\circ\text{C}$

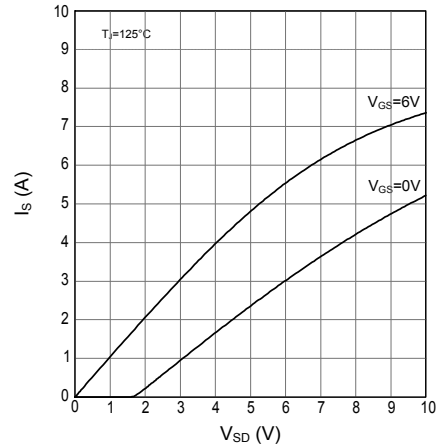


Figure 19. Safe Operating Area (LS) at $T_J=25^\circ\text{C}$

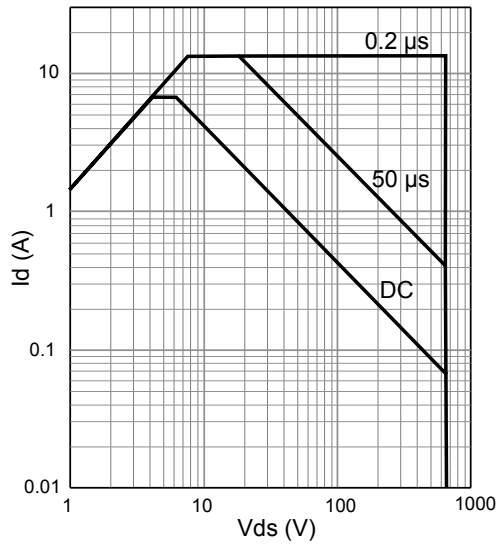


Figure 20. Safe Operating Area (HS) at $T_J=25^\circ\text{C}$

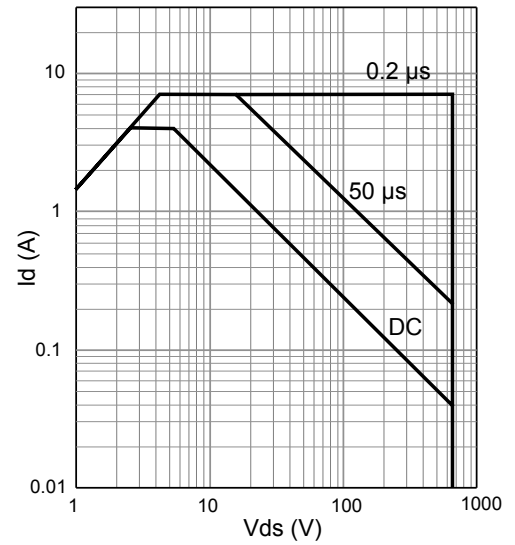


Figure 21. Typical Gate Charge (LS) at $T_J=25^\circ\text{C}$

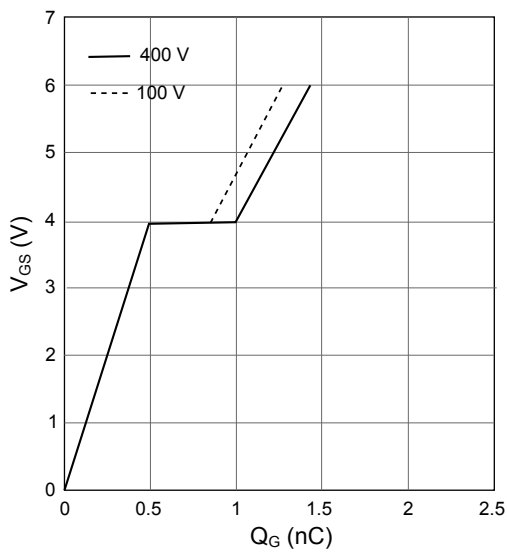


Figure 22. Typical Gate Charge (HS) at $T_J=25^\circ\text{C}$

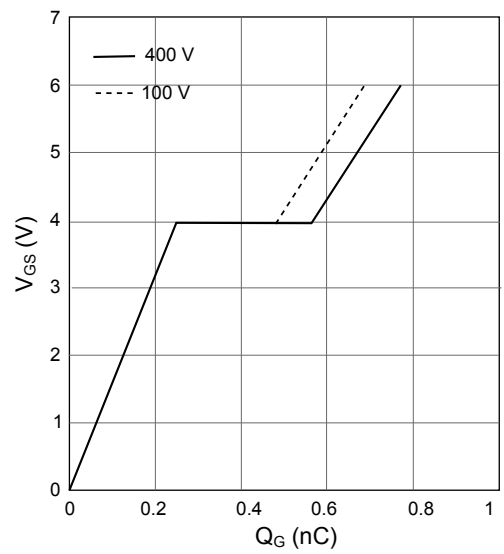


Figure 23. LS Derating curve

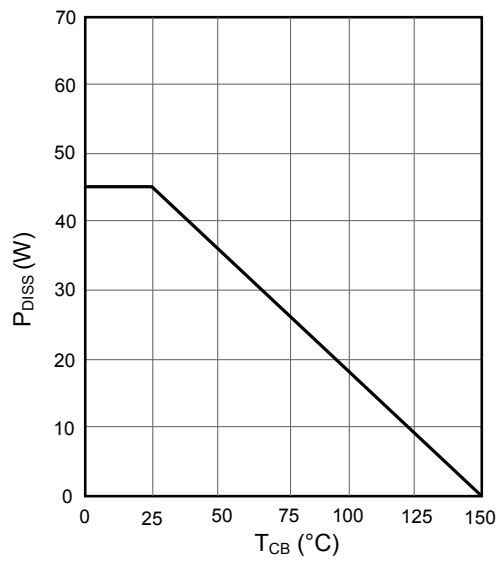


Figure 24. HS Derating curve

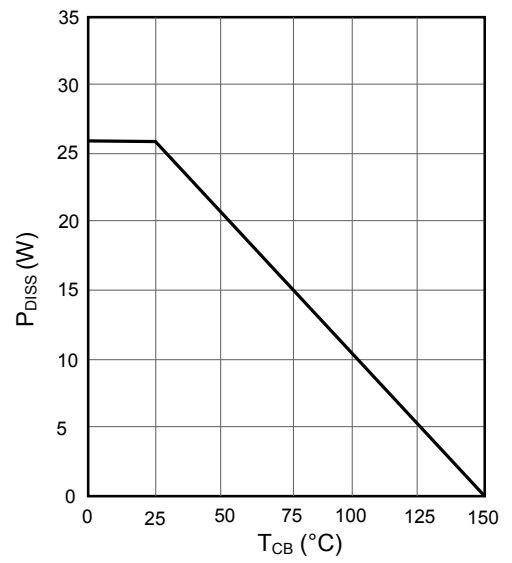
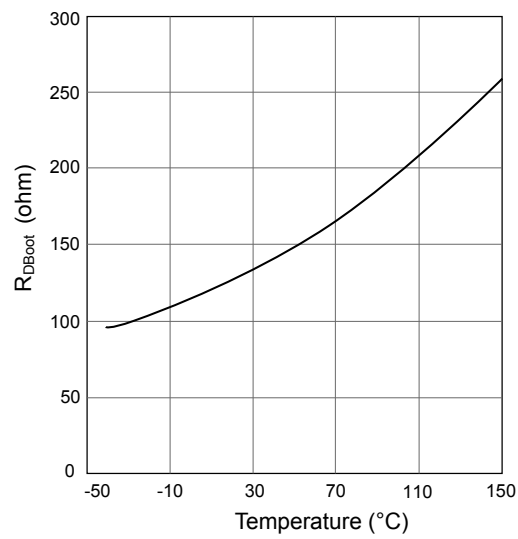


Figure 25. Typ R_{Dboot} vs. T_J



6 Functional description

6.1 Logic inputs

The **MASTERGAN3** features a half-bridge gate driver with three logic inputs to control the internal high-side and low-side GaN transistors.

The devices are controlled through the following logic inputs:

- $\overline{\text{SD/OD}}$: Shutdown input, active low
- LIN: low-side driver inputs, active high
- HIN: high-side driver inputs, active high

Table 9. Inputs truth table (applicable when device is not in UVLO)

Input pins			GaN transistors status	
$\overline{\text{SD/OD}}$	LIN	HIN	LS	HS
L	X ⁽¹⁾	X ⁽¹⁾	OFF	OFF
H	L	L	OFF	OFF
H	L	H	OFF	ON
H	H	L	ON	OFF
H	H ⁽²⁾	H ⁽²⁾	OFF	OFF

1. X: Don't care

2. Interlocking

The logic inputs have internal pull-down resistors. The purpose of these resistors is to set a proper logic level in case, for example, there is an interruption in the logic lines or the controller outputs are in tri-state conditions.

If logic inputs are left floating, the gate driver outputs are set to low level and the correspondent GaN transistors are turned off.

The minimum duration of the on time of the pulses applied to LIN is $T_{\text{IN_MIN}} = 120 \text{ ns}$; shorter pulses shall be either extended to $T_{\text{IN_MIN}}$ or blanked, when shorter than 30ns (typ).

The minimum duration of the off time of the pulses applied to HIN is $T_{\text{IN_MIN}} = 120 \text{ ns}$; shorter pulses shall be either extended to $T_{\text{IN_MIN}}$ or blanked, when shorter than 30 ns (typ).

Interlocking feature interrupts running $T_{\text{IN_MIN}}$ to avoid unexpected cross-conduction.

Matched, short propagation delay between low side and high side are there.

6.2 Bootstrap structure

A bootstrap circuitry is typically used to supply the high-voltage section. **MASTERGAN3** integrates this structure, realized by a patented integrated high-voltage DMOS, to reduce the external components.

The Bootstrap integrated circuit is connected to VCC pin and is driven synchronously with the low-side driver.

The use of an external bootstrap diode in parallel to the integrated structure is possible, in particular if the operating frequency is approximately higher than 500 kHz.

6.3 VCC supply pins and UVLO function

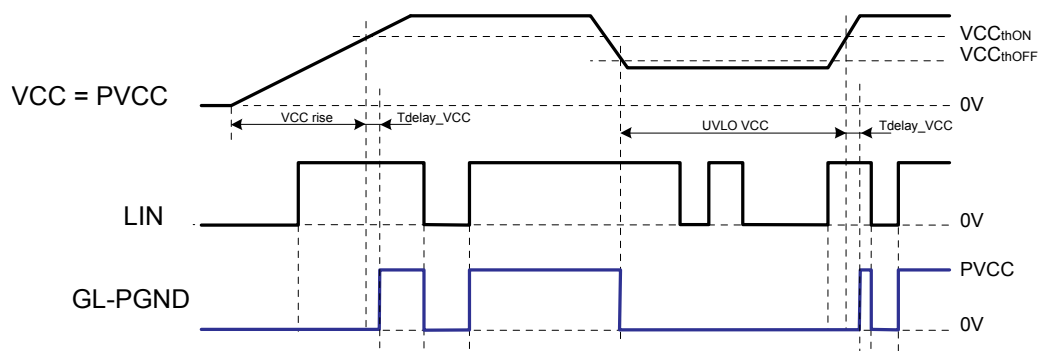
The VCC pin supplies current to the logic circuit, level-shifters in the low-side section and the integrated bootstrap diode.

The PVCC pin supplies low-side output buffer. During output commutations the average current used to provide gate charge to the high-side and low-side GaN transistors flows through this pin.

The PVCC pin can be connected either to the same supply voltage of the VCC pin or to a separate voltage source. In case the same voltage source is used, it is suggested to connect VCC and PVCC pins by means of a small decoupling resistance. The use of dedicated bypass ceramic capacitors located as close as possible to each supply pin is highly recommended.

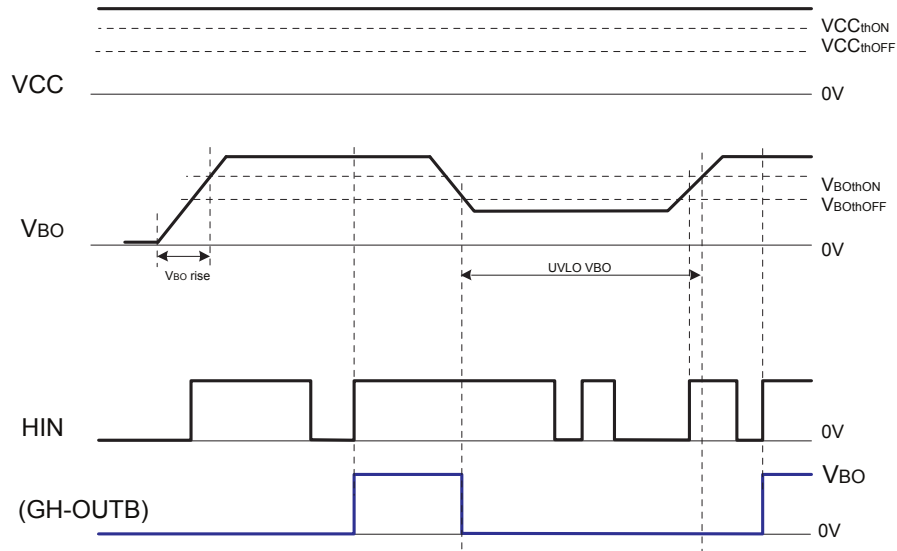
The MASTERGAN3 VCC supply voltage is continuously monitored by under-voltage lockout (UVLO) circuitry that turns both the high-side and low-side GaN transistors off when the supply voltage goes below the V_{CC_thOFF} threshold. The UVLO circuitry turns on the GaN, according to LIN and HIN status, approximately 20 μs (typ) after the supply voltage goes above the V_{CCthON} voltage. A V_{CChys} hysteresis is provided for noise rejection purposes.

Figure 26. VCC UVLO and Low Side



6.4 V_{BO} UVLO protection

Dedicated undervoltage protection is available on the bootstrap section between BOOT and OUTb supply pins. In order to avoid intermittent operation, a hysteresis sets the turn-off threshold with respect to the turn-on threshold. Approximately 5 μs (typ) after V_{BO} voltage falls below $V_{BOthOFF}$ threshold, the high-side GaN transistor is switched off. When V_{BO} voltage reaches the V_{BOthON} threshold, the device returns to normal operation and the output remains off until the next input pin transition that requests the high-side to turn on.

Figure 27. V_{BO} UVLO and High Side


6.5 Thermal shutdown

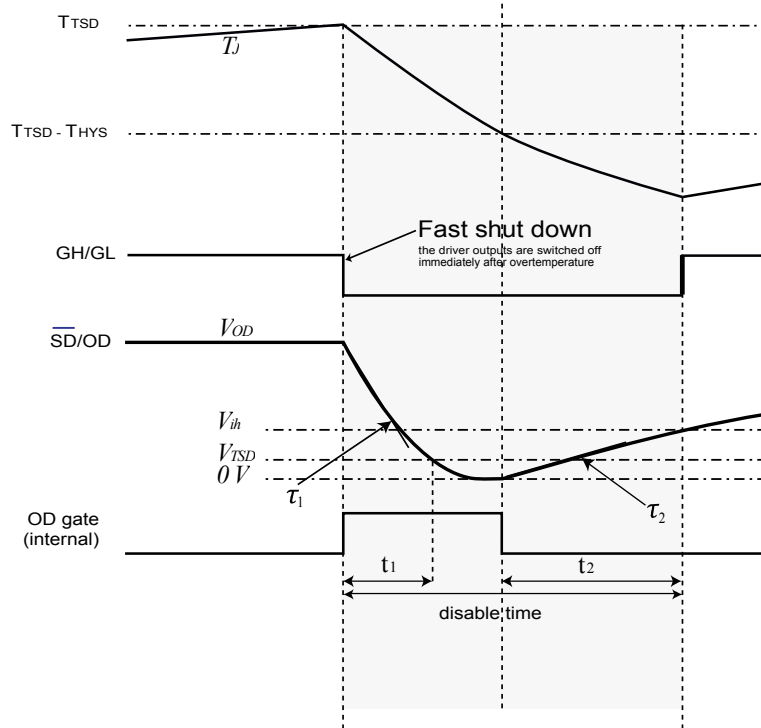
The integrated gate driver has a thermal shutdown protection.

When junction temperature reaches the T_{TSD} temperature threshold, the device turns off both GaN transistors, leaving the half-bridge in 3-state and signaling the state forcing $\overline{SD/OD}$ pin low. $\overline{SD/OD}$ pin is released when junction temperature is below $T_{TSD}-T_{HYS}$ and $\overline{SD/OD}$ is below V_{TSD} .

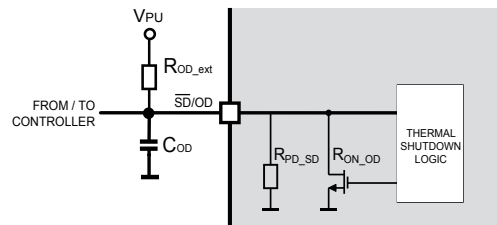
GaN are driven again according to inputs when $\overline{SD/OD}$ rises above V_{ih} .

The thermal smart shutdown system provides the possibility to increase the time constant of the external RC network (that determines the disable time after the overtemperature event) up to very large values without delaying the protection.

Figure 28. Thermal shutdown timing waveform

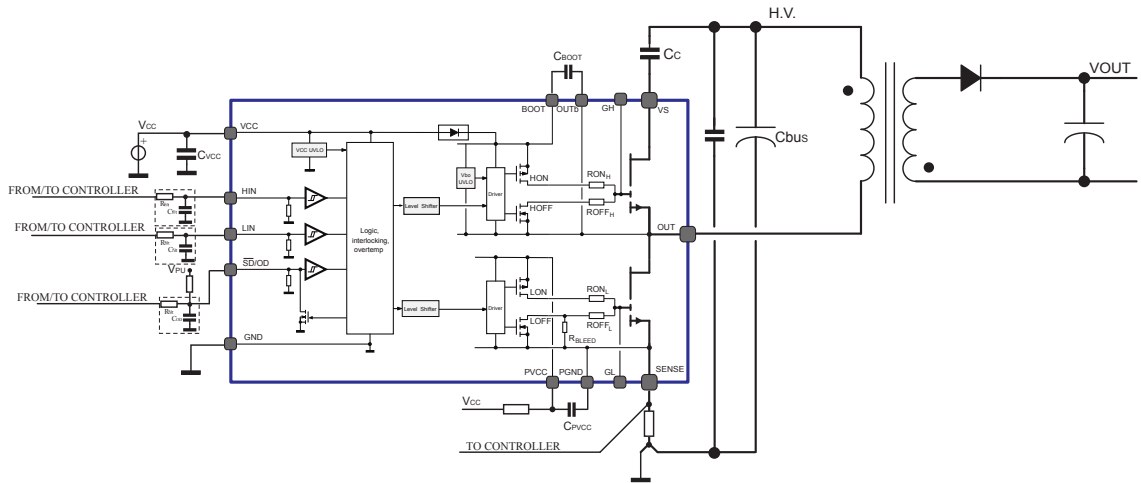


THERMAL SHUTDOWN CIRCUIT



7 Typical application diagrams

Figure 29. Asymmetrical Active clamp flyback



8 Package information

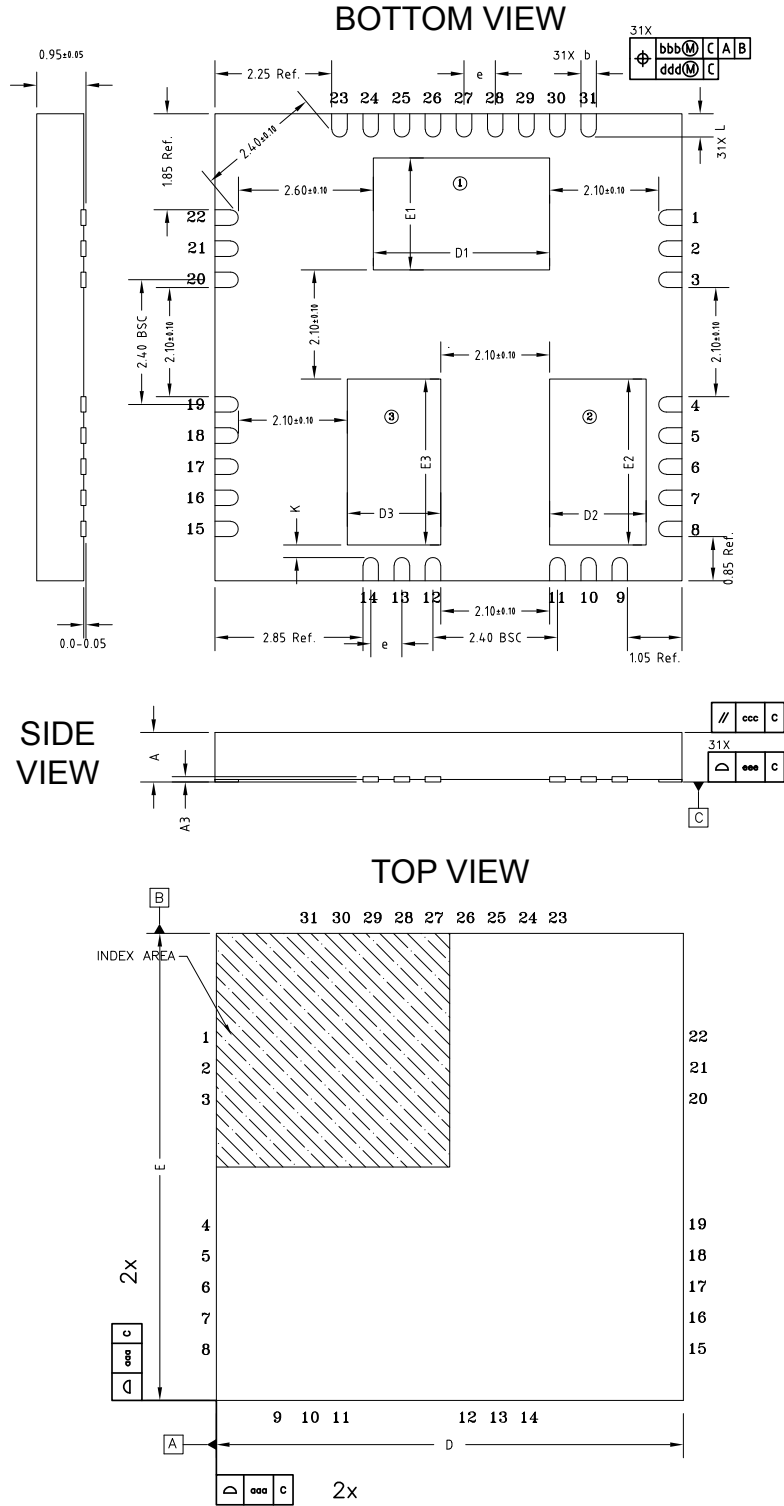
In order to meet environmental requirements, ST offers these devices in different grades of **ECOPACK** packages, depending on their level of environmental compliance. ECOPACK specifications, grade definitions and product status are available at: www.st.com. ECOPACK is an ST trademark.

8.1 QFN 9 x 9 x 1 mm, 31 leads, pitch 0.6 mm package information

Table 10. QFN 9 x 9 x 1 mm package dimensions

Symbol	Dimensions (mm)		
	Min.	Typ.	Max.
A	0.90	0.95	1.00
A3		0.10	
b	0.25	0.30	0.35
D	8.96	9.00	9.04
E	8.96	9.00	9.04
D1	3.30	3.40	3.50
E1	2.06	2.16	2.26
D2	1.76	1.86	1.96
E2	3.10	3.20	3.30
D3	1.70	1.80	1.90
E3	3.10	3.20	3.30
e		0.60	
K		0.24	
L	0.35	0.45	0.55
N		31	
aaa		0.10	
bbb		0.10	
ccc		0.10	
ddd		0.05	
eee		0.08	

- Note:**
1. Dimensioning and tolerances conform to ASME Y14.5-2009.
 2. All dimensions are in millimeters.
 3. N total number of terminals.
 4. Dimensions do not include mold protrusion, not to exceed 0.15 mm.
 5. Package outline exclusive of metal burr dimensions.

Figure 30. QFN 9 x 9 x 1 mm package dimensions


10 Ordering information

Table 11. Order codes

Order code	Package	Package Marking	Packaging
MASTERGAN3	QFN 9 x 9 x 1 mm	MASTERGAN3	Tray
MASTERGAN3TR	QFN 9 x 9 x 1 mm	MASTERGAN3	Tape and Reel

Revision history

Table 12. Document revision history

Date	Version	Changes
07-May-2021	1	Initial release.

Contents

1	Block diagram	2
2	Pin description and connection diagram	3
2.1	Pin list	3
3	Electrical Data	4
3.1	Absolute maximum ratings	4
3.2	Recommended operating conditions	5
3.3	Thermal data	5
4	Electrical characteristics	6
4.1	Driver	6
4.2	GaN power transistor	8
5	Device characterization values	9
6	Functional description	17
6.1	Logic inputs	17
6.2	Bootstrap structure	17
6.3	VCC supply pins and UVLO function	17
6.4	V _{BO} UVLO protection	18
6.5	Thermal shutdown	19
7	Typical application diagrams	21
8	Package information	22
8.1	[Package name] package information	22
9	Suggested footprint	24
10	Ordering information	25
	Revision history	26
	Contents	27
	List of tables	28
	List of figures	29

List of tables

Table 1.	Pin description	3
Table 2.	Absolute maximum ratings	4
Table 3.	Recommended operating conditions	5
Table 4.	Thermal data	5
Table 5.	Driver electrical characteristics	6
Table 6.	GaN power transistor electrical characteristics	8
Table 7.	GaN power transistor characterization values	9
Table 8.	Inductive load switching characteristics	9
Table 9.	Inputs truth table (applicable when device is not in UVLO)	17
Table 10.	QFN 9 x 9 x 1 mm package dimensions	22
Table 11.	Order codes	25
Table 12.	Document revision history	26

List of figures

Figure 1.	MASTERGAN3 block diagram	2
Figure 2.	Pin connection (top view)	3
Figure 3.	Switching time definition	10
Figure 4.	Typ I_{D_LS} vs. V_{DS} at $T_J=25^\circ\text{C}$	11
Figure 5.	Typ I_{D_LS} vs. V_{DS} at $T_J=125^\circ\text{C}$	11
Figure 6.	Typ I_{D_HS} vs. V_{DS} at $T_J=25^\circ\text{C}$	11
Figure 7.	Typ I_{D_HS} vs. V_{DS} at $T_J=125^\circ\text{C}$	11
Figure 8.	Typ $R_{DS(on)_LS}$ vs. I_D at $T_J=25^\circ\text{C}$	12
Figure 9.	Typ $R_{DS(on)_LS}$ vs. I_D at $T_J=125^\circ\text{C}$	12
Figure 10.	Typ $R_{DS(on)_HS}$ vs. I_D at $T_J=25^\circ\text{C}$	12
Figure 11.	Typ $R_{DS(on)_HS}$ vs. I_D at $T_J=125^\circ\text{C}$	12
Figure 12.	Typ I_{D_LS} vs. V_{DS}	13
Figure 13.	Typ I_{D_HS} vs. V_{DS}	13
Figure 14.	Typ $R_{DS(on)}$ vs. T_J normalized at 25°C	13
Figure 15.	Typ I_{SD_LS} vs. V_{SD_LS} at $T_J=25^\circ\text{C}$	14
Figure 16.	Typ I_{SD_LS} vs. V_{SD_LS} at $T_J=125^\circ\text{C}$	14
Figure 17.	Typ I_{SD_HS} vs. V_{SD_HS} at $T_J=25^\circ\text{C}$	14
Figure 18.	Typ I_{SD_HS} vs. V_{SD_HS} at $T_J=125^\circ\text{C}$	14
Figure 19.	Safe Operating Area (LS) at $T_J=25^\circ\text{C}$	15
Figure 20.	Safe Operating Area (HS) at $T_J=25^\circ\text{C}$	15
Figure 21.	Typical Gate Charge (LS) at $T_J=25^\circ\text{C}$	15
Figure 22.	Typical Gate Charge (HS) at $T_J=25^\circ\text{C}$	15
Figure 23.	LS Derating curve	16
Figure 24.	HS Derating curve.	16
Figure 25.	Typ R_{Dboot} vs. T_J	16
Figure 26.	VCC UVLO and Low Side	18
Figure 27.	V_{BO} UVLO and High Side	19
Figure 28.	Thermal shutdown timing waveform	20
Figure 29.	Asymmetrical Active clamp flyback	21
Figure 30.	QFN 9 x 9 x 1 mm package dimensions	23
Figure 31.	Suggested footprint (top view drawing)	24

IMPORTANT NOTICE – PLEASE READ CAREFULLY

STMicroelectronics NV and its subsidiaries (“ST”) reserve the right to make changes, corrections, enhancements, modifications, and improvements to ST products and/or to this document at any time without notice. Purchasers should obtain the latest relevant information on ST products before placing orders. ST products are sold pursuant to ST’s terms and conditions of sale in place at the time of order acknowledgement.

Purchasers are solely responsible for the choice, selection, and use of ST products and ST assumes no liability for application assistance or the design of Purchasers’ products.

No license, express or implied, to any intellectual property right is granted by ST herein.

Resale of ST products with provisions different from the information set forth herein shall void any warranty granted by ST for such product.

ST and the ST logo are trademarks of ST. For additional information about ST trademarks, please refer to www.st.com/trademarks. All other product or service names are the property of their respective owners.

Information in this document supersedes and replaces information previously supplied in any prior versions of this document.

© 2021 STMicroelectronics – All rights reserved

X-ON Electronics

Largest Supplier of Electrical and Electronic Components

Click to view similar products for [Gate Drivers](#) category:

Click to view products by [STMicroelectronics](#) manufacturer:

Other Similar products are found below :

[00053P0231](#) [56956](#) [57.404.7355.5](#) [LT4936](#) [57.904.0755.0](#) [5882900001](#) [00600P0005](#) [00-9050-LRPP](#) [00-9090-RDPP](#) [5951900000](#) [01-1003W-10/32-15](#) [0131700000](#) [00-2240](#) [LTP70N06](#) [LVP640](#) [5J0-1000LG-SIL](#) [LY1D-2-5S-AC120](#) [LY2-US-AC240](#) [LY3-UA-DC24](#) [00576P0020](#) [00600P0010](#) [LZN4-UA-DC12](#) [LZNQ2M-US-DC5](#) [LZNQ2-US-DC12](#) [LZP40N10](#) [00-8196-RDPP](#) [00-8274-RDPP](#) [00-8275-RDNP](#) [00-8722-RDPP](#) [00-8728-WHPP](#) [00-8869-RDPP](#) [00-9051-RDPP](#) [00-9091-LRPP](#) [00-9291-RDPP](#) [0207100000](#) [0207400000](#) [01312](#) [0134220000](#) [60713816](#) [M15730061](#) [61161-90](#) [61278-0020](#) [6131-204-23149P](#) [6131-205-17149P](#) [6131-209-15149P](#) [6131-218-17149P](#) [6131-220-21149P](#) [6131-260-2358P](#) [6131-265-11149P](#) [CS1HCPU63](#)