

RobuST low-power dual operational amplifier

Datasheet - production data

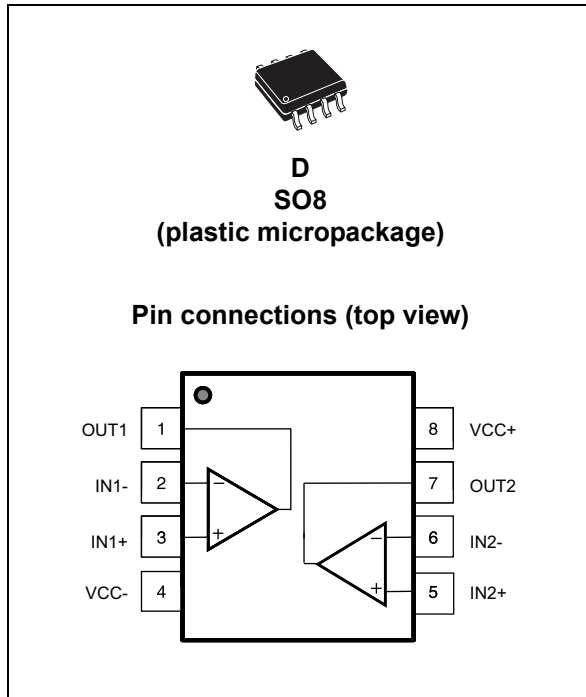

- Intended for use in aerospace and defense applications:
 - Dedicated traceability and part marking
 - Approval documents available for production parts
 - Adapted extended life time and obsolescence management
 - Extended product change notification process
 - Designed and manufactured to meet sub ppm quality goals
 - Advanced mold and frame designs for superior resilience to harsh environments (acceleration, EMI, thermal, humidity)
 - Extended screening capability on request
 - Single fabrication, assembly, and test site
 - Temperature range (-40 °C to 150 °C)

Applications

- Aerospace and defense
- Harsh environments

Features

- Frequency compensation implemented internally
- Large DC voltage gain: 100 dB
- Wide bandwidth (unity gain): 1.1 MHz (temperature compensated)
- Very low supply current/amplifier, essentially independent of supply voltage
- Low input bias current: 20 nA (temperature compensated)
- Low input offset current: 2 nA
- Input common-mode voltage range includes negative rail
- Differential input voltage range equal to the power supply voltage
- Large output voltage swing 0 V to (V_{CC+}) - 1.5V

Description

This circuit consists of two independent, high gain operational amplifiers with frequency compensation implemented internally. It is designed specifically for aerospace and defense applications. The circuit operates from a single power supply over a wide range of voltages. Low power supply drain is independent of the magnitude of the power supply voltage.

In linear mode, the input common-mode voltage range includes ground and the output voltage can also swing to ground, even though operated from a single power supply.

Contents

- 1 Absolute maximum ratings and operating conditions 3**
- 2 Schematic diagram 4**
- 3 Electrical characteristics 5**
- 4 Package information 10**
 - 4.1 SO8 package information11
- 5 Ordering information 12**
- 6 Revision history 12**

1 Absolute maximum ratings and operating conditions

Table 1. Absolute maximum ratings

Symbol	Parameter	Value	Unit
V_{CC}^+	Supply voltage	32	V
V_{id}	Differential input voltage	-0.3 to $V_{CC}+0.3$	
V_{in}	Input voltage	-0.3 to $V_{CC}+0.3$	
	Output short-circuit to ground ⁽¹⁾	40	mA
T_j	Maximum junction temperature	150	°C
R_{thja}	Thermal resistance junction to ambient ⁽²⁾	125	°C/W
R_{thjc}	Thermal resistance junction to case ⁽²⁾	40	
I_{in}	Input current ⁽³⁾	5	mA
T_{stg}	Storage temperature range	-65 to 150	°C
ESD	HBM: human body model ⁽⁴⁾	2	kV
	MM: machine model ⁽⁵⁾	200	V
	CDM: charged device model ⁽⁶⁾	1.5	kV

- Short-circuits from the output to V_{CC} can cause excessive heating if $V_{CC}^+ > 15$ V. The maximum output current is approximately 40 mA, independent of the magnitude of V_{CC} . Destructive dissipation can result from simultaneous short-circuits on all amplifiers.
- Short-circuits can cause excessive heating and destructive dissipation. Values are typical.
- This input current only exists when the voltage values applied on the inputs is beyond the supply voltage line limits. This is not destructive if the current does not exceed 5 mA as indicated, and normal output is restored for input voltages above -0.3 V.
- Human body model: A 100 pF capacitor is charged to the specified voltage, then discharged through a 1.5k Ω resistor between two pins of the device. This is done for all couples of connected pin combinations while the other pins are floating.
- Machine model: A 200 pF capacitor is charged to the specified voltage, then discharged directly between two pins of the device with no external series resistor (internal resistor < 5 Ω). This is done for all couples of connected pin combinations while the other pins are floating.
- Charged device model: all pins and the package are charged together to the specified voltage and then discharged directly to the ground through only one pin. This is done for all pins.

Table 2. Operating conditions

Symbol	Parameter	Value	Unit
V_{CC}^+	Supply voltage	3 to 30	V
T_{oper}	Operating free-air temperature range	-40 to 150	°C
V_{icm}	Input common mode voltage range ($V_{CC}^+=+30V$) ⁽¹⁾ $T_{amb} = 25$ °C $T_{min} \leq T_{amb} \leq T_{max}$	0 to (V_{CC}^+) - 1.5 0 to (V_{CC}^+) - 2	V

- The input common-mode voltage of either input signal voltage should not be allowed to go negative by more than 0.3 V. The upper end of the common-mode voltage range is $V_{CC}^+ - 1.5$ V, but either or both inputs can go to +32 V without damage.

3 Electrical characteristics

**Table 3. $V_{CC}^+ = 5V$, $V_{CC}^- = \text{ground}$, $V_O = 1.4 V$, $T_{\text{amb}} = 25\text{ }^\circ\text{C}$
(unless otherwise specified)**

Symbol	Parameter	Min.	Typ.	Max.	Unit
V_{io}	Input offset voltage ⁽¹⁾ $T_{\text{min}} \leq T_{\text{amb}} \leq T_{\text{max}}$		2	7 9	mV
I_{io}	Input offset current $T_{\text{min}} \leq T_{\text{amb}} \leq T_{\text{max}}$		2	30 40	nA
I_{ib}	Input bias current ⁽²⁾ $T_{\text{min}} \leq T_{\text{amb}} \leq T_{\text{max}}$		20	150 200	
A_{vd}	Large signal voltage gain $V_{CC}^+ = 15 V$, $R_L = 2\text{ k}\Omega$, $V_O = 1.4 V$ to $11.4 V$ $T_{\text{min}} \leq T_{\text{amb}} \leq T_{\text{max}}$	50 2.5	100		V/mV
SVR	Supply voltage rejection ratio $V_{CC}^+ = 5$ to $30 V$, $R_S \leq 10\text{ k}\Omega$ $T_{\text{min}} \leq T_{\text{amb}} \leq T_{\text{max}}$	65 65	100		dB
I_{CC}	Supply current, all amps, no load $V_{CC}^+ = 5 V$ $T_{\text{min}} \leq T_{\text{amb}} \leq T_{\text{max}}$, $V_{CC} = 30 V$		0.7	1.2 2	mA
CMR	Common-mode rejection ratio ($R_S = 10\text{ k}\Omega$) $T_{\text{min}} \leq T_{\text{amb}} \leq T_{\text{max}}$	70 60	85		dB
I_{source}	Output short-circuit current $V_{CC}^+ = 15 V$, $V_O = 2 V$, $V_{id} = 1 V$ $T_{\text{min}} \leq T_{\text{amb}} \leq T_{\text{max}}$	20 10	40	60	mA
I_{sink}	Output sink current $V_O = 2 V$, $V_{CC}^+ = 5 V$ $T_{\text{min}} \leq T_{\text{amb}} \leq T_{\text{max}}$	10 5	20		mA
	$V_O = 0.2 V$, $V_{CC}^+ = 15 V$ $T_{\text{min}} \leq T_{\text{amb}} \leq T_{\text{max}}$	12 10	50		μA
V_{OPP}	Output voltage swing ($R_L = 2\text{ k}\Omega$) $T_{\text{min}} \leq T_{\text{amb}} \leq T_{\text{max}}$	0 0		$(V_{CC}^+) - 1.5$ $(V_{CC}^+) - 2$	V
V_{OH}	High level output voltage ($V_{CC}^+ = 30 V$) $R_L = 2\text{ k}\Omega$ $T_{\text{min}} \leq T_{\text{amb}} \leq T_{\text{max}}$	26 26	27		
	$R_L = 10\text{ k}\Omega$ $T_{\text{min}} \leq T_{\text{amb}} \leq T_{\text{max}}$	27 27	28		
V_{OL}	Low level output voltage ($R_L = 10\text{ k}\Omega$) $T_{\text{min}} \leq T_{\text{amb}} \leq T_{\text{max}}$		5	20 20	mV

**Table 3. $V_{CC}^+ = 5V$, $V_{CC}^- = \text{ground}$, $V_O = 1.4 V$, $T_{\text{amb}} = 25\text{ }^\circ\text{C}$
(unless otherwise specified) (continued)**

Symbol	Parameter	Min.	Typ.	Max.	Unit
SR	Slew rate (unity gain) $V_{CC}^+ = 15 V$, $V_i = 0.5$ to $3 V$, $R_L = 2\text{ k}\Omega$, $C_L = 100\text{ pF}$, $T_{\text{min}} \leq T_{\text{amb}} \leq T_{\text{max}}$	0.3 0.2	0.6		V/ μs
GBP	Gain bandwidth product $f = 100\text{ kHz}$ $V_{CC}^+ = 30 V$, $V_{\text{in}} = 10\text{ mV}$, $R_L = 2\text{ k}\Omega$, $C_L = 100\text{ pF}$ $T_{\text{min}} \leq T_{\text{amb}} \leq T_{\text{max}}$	0.7 0.45	1.1		MHz
THD	Total harmonic distortion $f = 1\text{ kHz}$, $A_V = 20\text{ dB}$, $R_L = 2\text{ k}\Omega$, $V_O = 2 V_{\text{pp}}$, $C_L = 100\text{ pF}$, $V_{CC} = 30 V$		0.02		%
e_n	Equivalent input noise voltage, $f = 1\text{ kHz}$, $R_S = 100\text{ }\Omega$, $V_{CC} = 30 V$		55		nV/ $\sqrt{\text{Hz}}$
DV_{iO}	Input offset voltage drift		7	30	$\mu\text{V}/^\circ\text{C}$
DI_{iO}	Input offset current drift		10	300	pA/ $^\circ\text{C}$
V_{O1}/V_{O2}	Channel separation ⁽³⁾ $1\text{ kHz} \leq f \leq 20\text{ kHz}$		120		dB

- $V_O = 1.4 V$, $R_S = 0\text{ }\Omega$, $5 V < V_{CC}^+ < 30 V$, $0 V < V_{iC} < (V_{CC}^+) - 1.5 V$.
- The direction of the input current is out of the IC. This current is essentially constant, independent of the state of the output, so there is no change in the loading charge on the input lines.
- Due to the proximity of external components, ensure that stray capacitance does not cause coupling between these external parts. Typically, this can be detected because this type of capacitance increases at higher frequencies.

Figure 2. Open-loop frequency response

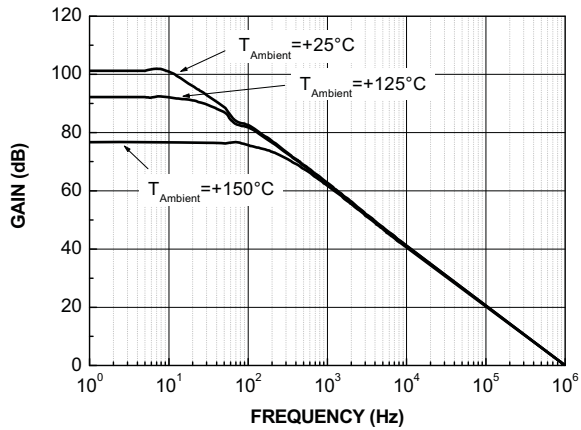

Figure 3. Large signal frequency response

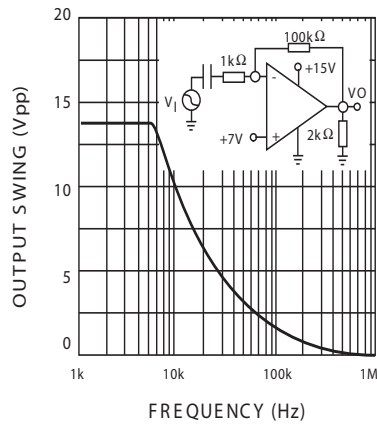

Figure 4. Voltage follower pulse response

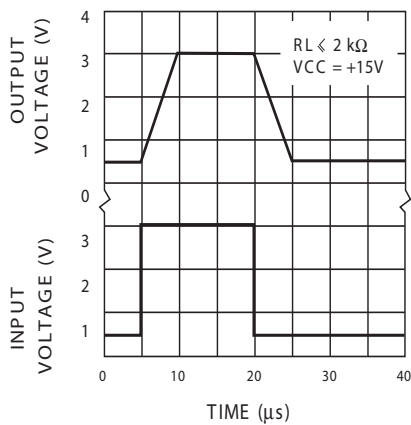

Figure 5. Input bias current

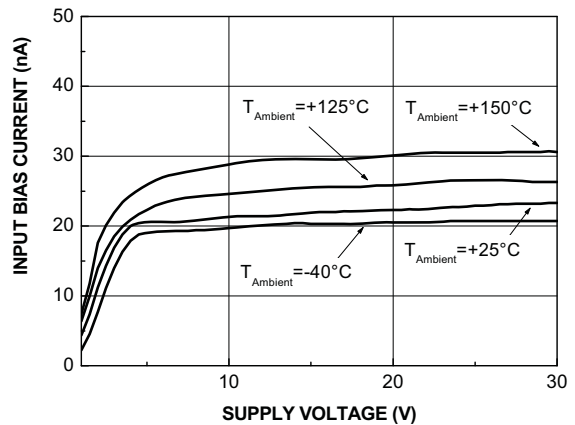

Figure 6. Supply current

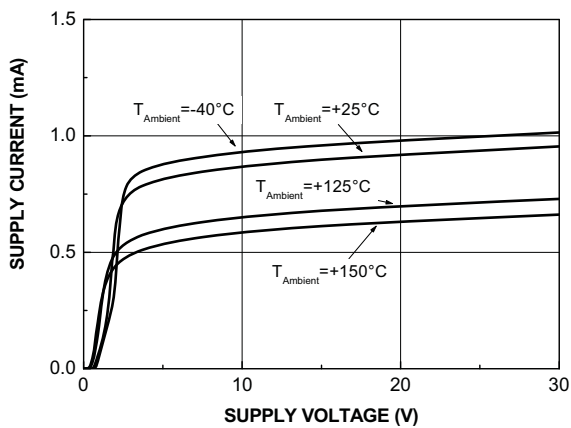

Figure 7. Output characteristics vs. +VCC

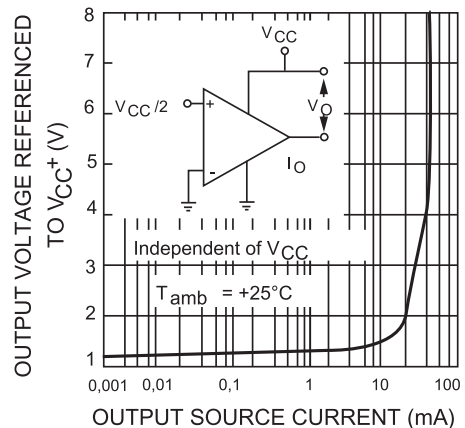

Figure 8. Output characteristics vs. GND

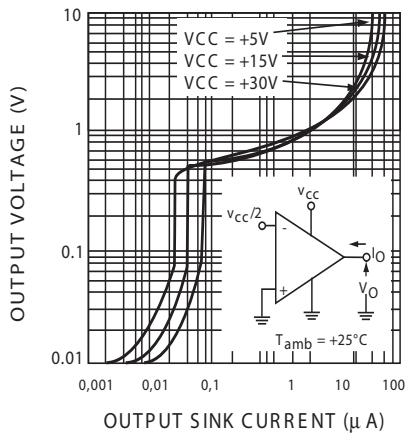

Figure 9. Current limiting

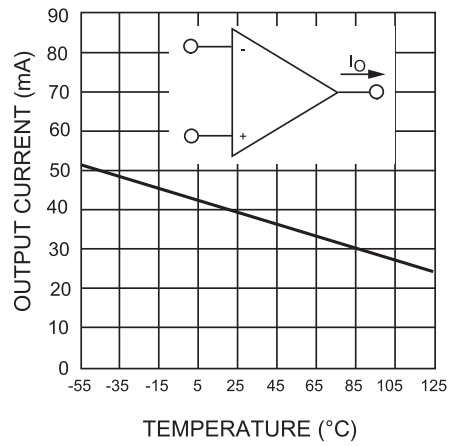

Figure 10. Voltage follower pulse response on 50 pF

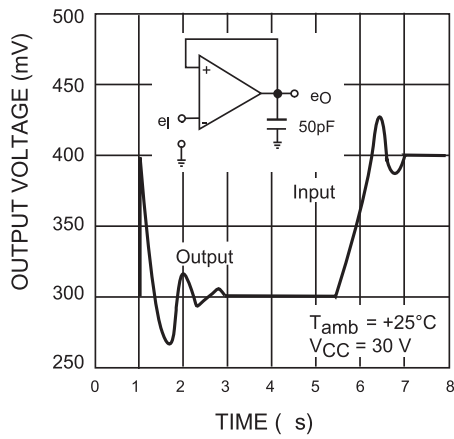

Figure 11. Input voltage range

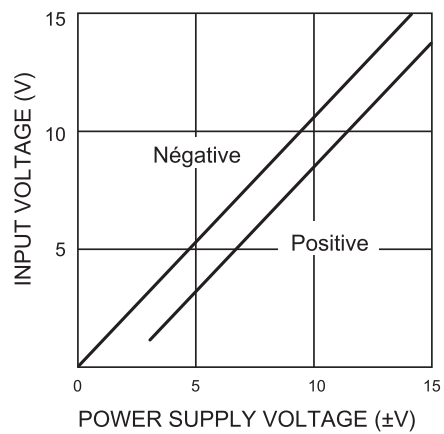

Figure 12. Voltage gain

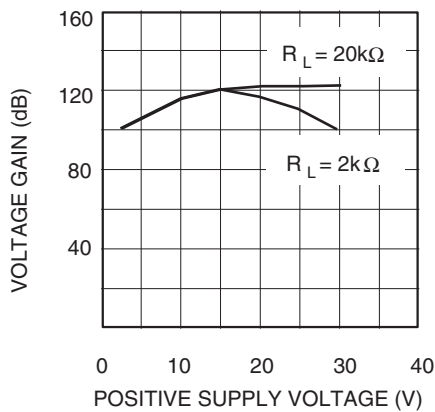

Figure 13. Gain bandwidth product

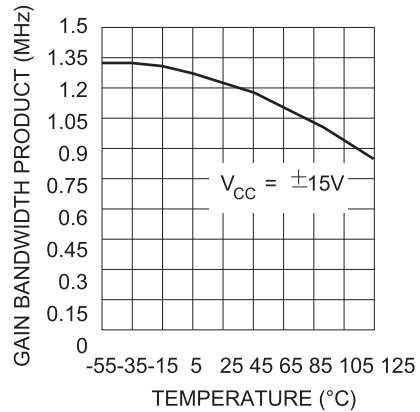

Figure 14. Power supply rejection ratio versus temperature

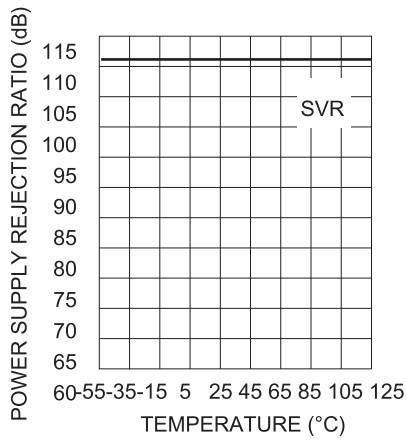
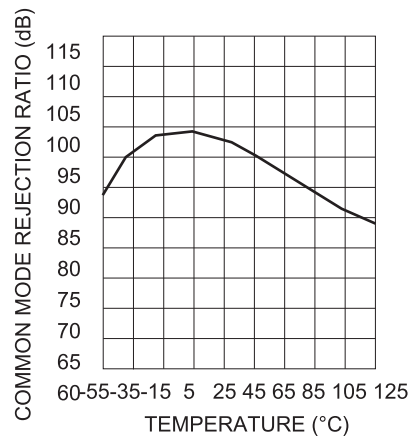

Figure 15. Common mode rejection ratio versus temperature



4 Package information

In order to meet environmental requirements, ST offers these devices in different grades of ECOPACK[®] packages, depending on their level of environmental compliance. ECOPACK[®] specifications, grade definitions and product status are available at: www.st.com. ECOPACK[®] is an ST trademark.

4.1 SO8 package information

Figure 16. SO8 package mechanical drawing

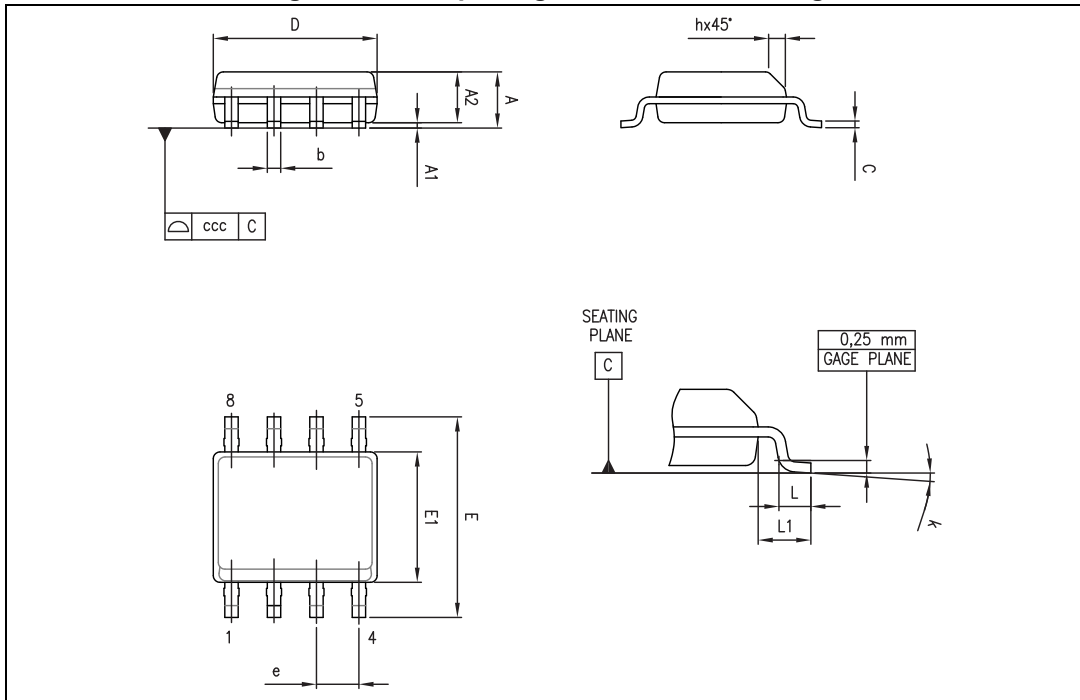

Table 4. SO8 package mechanical data

Ref.	Dimensions					
	Millimeters			Inches		
	Min.	Typ.	Max.	Min.	Typ.	Max.
A			1.75			0.069
A1	0.10		0.25	0.004		0.010
A2	1.25			0.049		
b	0.28		0.48	0.011		0.019
c	0.17		0.23	0.007		0.010
D	4.80	4.90	5.00	0.189	0.193	0.197
E	5.80	6.00	6.20	0.228	0.236	0.244
E1	3.80	3.90	4.00	0.150	0.154	0.157
e		1.27			0.050	
h	0.25		0.50	0.010		0.020
L	0.40		1.27	0.016		0.050
L1		1.04			0.040	
k	1°		8°	1°		8°
ccc			0.10			0.004

5 Ordering information

Table 5. Order codes

Order code	Temperature range	Package	Packing	Marking
RT2904WHYDT	-40 °C to 150 °C	SO8	Tape and reel	R2904WHY

6 Revision history

Table 6. Document revision history

Date	Revision	Changes
08-Oct-2014	1	Initial release.

IMPORTANT NOTICE – PLEASE READ CAREFULLY

STMicroelectronics NV and its subsidiaries (“ST”) reserve the right to make changes, corrections, enhancements, modifications, and improvements to ST products and/or to this document at any time without notice. Purchasers should obtain the latest relevant information on ST products before placing orders. ST products are sold pursuant to ST’s terms and conditions of sale in place at the time of order acknowledgement.

Purchasers are solely responsible for the choice, selection, and use of ST products and ST assumes no liability for application assistance or the design of Purchasers’ products.

No license, express or implied, to any intellectual property right is granted by ST herein.

Resale of ST products with provisions different from the information set forth herein shall void any warranty granted by ST for such product.

ST and the ST logo are trademarks of ST. All other product or service names are the property of their respective owners.

Information in this document supersedes and replaces information previously supplied in any prior versions of this document.

© 2014 STMicroelectronics – All rights reserved



X-ON Electronics

Largest Supplier of Electrical and Electronic Components

Click to view similar products for [Analog Comparators](#) category:

Click to view products by [STMicroelectronics](#) manufacturer:

Other Similar products are found below :

[633740E](#) [ADCMP396ARZ-RL7](#) [NCV2200SN2T1G](#) [NCV2200SQ2T2G](#) [SC339DR2G](#) [LM2901SNG](#) [LM339SNG](#) [AP393AM8G-13](#)
[418524AB](#) [TS393CD C3](#) [LM393SNG](#) [55122](#) [5962-8757203IA](#) [MAX971ESA+T](#) [MAX961ESAT](#) [MAX944ESD+T](#) [MAX931ESAT](#)
[MAX984CPE](#) [MAX9062EBSTG45](#) [MAX9041AEUTT](#) [MAX9022ASAT](#) [RT2902YDT](#) [M38510/11201B2A](#) [NTE911](#) [5962-8751601DA](#)
[5962-8751601CA](#) [MAX961EUA+T](#) [MAX9065EBS+TG45](#) [NCV2202SN2T1G](#) [MAX919ESA+T](#) [LT6700HS6-2#TRMPBF](#) [MAX19005CCS+](#)
[LM339EDR2G](#) [LT6700HS6-2#TRM](#) [NTE919](#) [NTE922](#) [TS883IQ2T](#) [LT6700HVCS6-3#TRMPBF](#) [LT6700HVHS6-3#TRMPBF](#)
[MAX978EEE+T](#) [MAX975ESA+T](#) [MAX9602EUG+T](#) [MAX997EUA+T](#) [MIC841NYC5-T5](#) [LM393WDT](#) [MCP6564T-E/STVAO](#)
[MAX983ESA+T](#) [NCX2200GMAZ](#) [LTC1540CMS8#PBF](#) [MC10E1651FNG](#)