

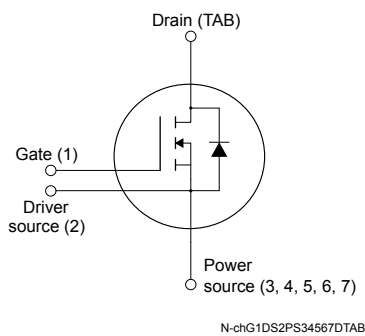

Automotive-grade silicon carbide Power MOSFET 650 V, 40 mΩ typ., 30 A in an HU3PAK package

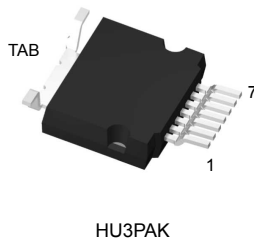

Features

Order code	V _{DS}	R _{DS(on)} typ.	I _D
SCT040HU65G3AG	650 V	40 mΩ	30 A

- AEC-Q101 qualified 
- Very low R_{DS(on)} over the entire temperature range
- High speed switching performances
- Very fast and robust intrinsic body diode
- Source sensing pin for increased efficiency

Applications

- Main inverter (electric traction)
- DC/DC converter for EV/HEV
- On board charger (OBC)

Description

This silicon carbide Power MOSFET device has been developed using ST's advanced and innovative 3rd generation SiC MOSFET technology. The device features a very low R_{DS(on)} over the entire temperature range combined with low capacitances and very high switching operations, which improve application performance in frequency, energy efficiency, system size and weight reduction.

Product status link

[SCT040HU65G3AG](#)

Product summary

Order code	SCT040HU65G3AG
Marking	SCT40HU65G3AG
Package	HU3PAK
Packing	Tape and reel

1 Electrical ratings

Table 1. Absolute maximum ratings

Symbol	Parameter	Value	Unit
V_{DS}	Drain-source voltage	650	V
V_{GS}	Gate-source voltage	-10 to 22	V
	Gate-source voltage (recommended operating values)	-5 to 18	
	Gate-source transient voltage, $t_p < 1 \mu s$, $t \leq 10$ hours over lifetime	-11 to 25	
$I_D^{(1)}$	Drain current (continuous) at $T_C = 25 \text{ }^\circ\text{C}$	30	A
	Drain current (continuous) at $T_C = 100 \text{ }^\circ\text{C}$	30	
$I_{DM}^{(2)}$	Drain current (pulsed)	160	A
P_{TOT}	Total power dissipation at $T_C = 25 \text{ }^\circ\text{C}$	221	W
T_{stg}	Storage temperature range	-55 to 175	$^\circ\text{C}$
T_J	Operating junction temperature range		$^\circ\text{C}$

- I_D is limited by package.
- Pulse width is limited by safe operating area.

Table 2. Thermal data

Symbol	Parameter	Value	Unit
R_{thJC}	Thermal resistance, junction-to-case	0.68	$^\circ\text{C}/\text{W}$
R_{thJA}	Thermal resistance, junction-to-ambient	50	$^\circ\text{C}/\text{W}$

2 Electrical characteristics

$T_C = 25\text{ }^\circ\text{C}$ unless otherwise specified.

Table 3. On/off states

Symbol	Parameter	Test conditions	Min.	Typ.	Max.	Unit
$V_{(BR)DSS}$	Drain-source breakdown voltage	$V_{GS} = 0\text{ V}, I_D = 1\text{ mA}$	650			V
I_{DSS}	Zero gate voltage drain current	$V_{GS} = 0\text{ V}, V_{DS} = 650\text{ V}$			10	μA
I_{GSS}	Gate-body leakage current	$V_{DS} = 0\text{ V}, V_{GS} = -10\text{ to }22\text{ V}$			± 100	nA
$V_{GS(th)}$	Gate threshold voltage	$V_{DS} = V_{GS}, I_D = 1\text{ mA}$	1.8	3.0	4.2	V
$R_{DS(on)}$	Static drain-source on-resistance	$V_{GS} = 15\text{ V}, I_D = 20\text{ A}$		50		m Ω
		$V_{GS} = 18\text{ V}, I_D = 20\text{ A}$		40	55	
		$V_{GS} = 18\text{ V}, I_D = 20\text{ A}, T_J = 175\text{ }^\circ\text{C}$		50		

Table 4. Dynamic

Symbol	Parameter	Test conditions	Min.	Typ.	Max.	Unit
C_{iss}	Input capacitance	$V_{DS} = 400\text{ V}, f = 1\text{ MHz}, V_{GS} = 0\text{ V}$	-	920	-	pF
C_{oss}	Output capacitance		-	94	-	pF
C_{riss}	Reverse transfer capacitance		-	13	-	pF
Q_g	Total gate charge	$V_{DD} = 400\text{ V}, V_{GS} = -5\text{ to }18\text{ V}, I_D = 20\text{ A}$	-	39.5	-	nC
Q_{gs}	Gate-source charge		-	11.5	-	nC
Q_{gd}	Gate-drain charge		-	14.5	-	nC
R_g	Gate input resistance	$f = 1\text{ MHz}, I_D = 0\text{ A}$	-	1.4	-	Ω

Table 5. Switching energy (inductive load)

Symbol	Parameter	Test conditions	Min.	Typ.	Max.	Unit
E_{on}	Turn-on switching energy	$V_{DD} = 400\text{ V}, I_D = 20\text{ A},$	-	79	-	μJ
E_{off}	Turn-off switching energy	$R_G = 15\text{ }\Omega, V_{GS} = -5\text{ V to }18\text{ V}$	-	67	-	μJ

Table 6. Switching times

Symbol	Parameter	Test conditions	Min.	Typ.	Max.	Unit
$t_{d(on)}$	Turn-on delay time	$V_{DD} = 400\text{ V}, I_D = 20\text{ A},$ $R_G = 15\text{ }\Omega, V_{GS} = -5\text{ to }18\text{ V}$	-	10	-	ns
t_r	Rise time		-	17	-	ns
$t_{d(off)}$	Turn-off delay time		-	26	-	ns
t_f	Fall time		-	8	-	ns

Table 7. Reverse SiC diode characteristics

Symbol	Parameter	Test conditions	Min.	Typ.	Max.	Unit
$I_{SD}^{(1)}$	Continuous diode forward current	$T_C = 25\text{ }^\circ\text{C}$	-		30	A
		$T_C = 100\text{ }^\circ\text{C}$	-		30	
V_{SD}	Diode forward voltage	$I_{SD} = 20\text{ A}$, $V_{GS} = 0\text{ V}$	-	2.8		V
t_{rr}	Reverse recovery time	$I_{SD} = 20\text{ A}$, $di/dt = 1000\text{ A}/\mu\text{s}$, $V_{DD} = 400\text{ V}$	-	18		ns
Q_{rr}	Reverse recovery charge		-	97		nC
I_{RRM}	Reverse recovery current		-	9		A

1. I_{SD} is limited by package.

2.1 Electrical characteristics (curves)

Figure 1. Safe operating area

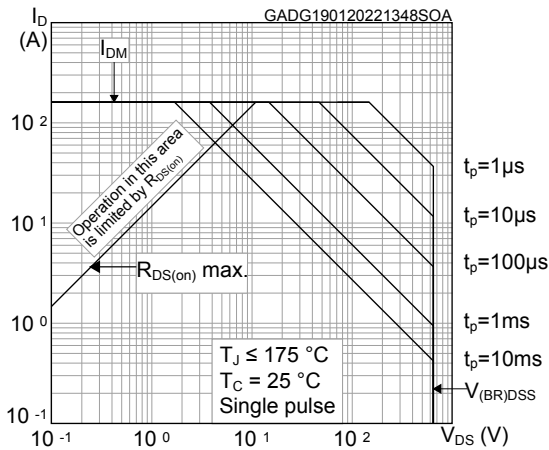

Figure 2. Maximum transient thermal impedance

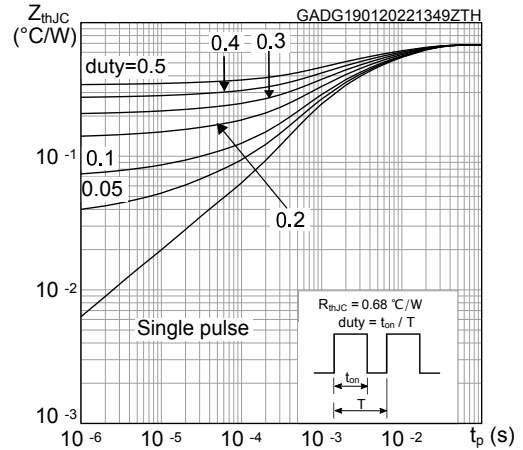

Figure 3. Typical output characteristics ($T_J = 25^\circ C$)

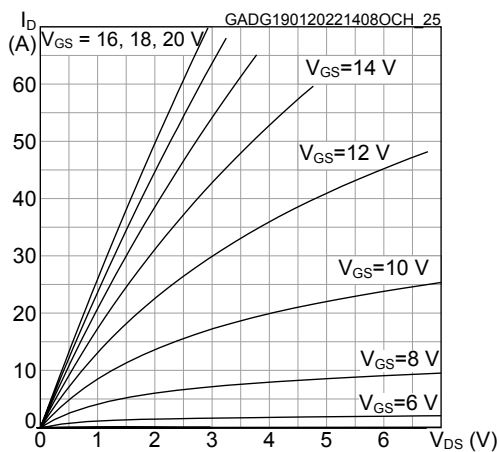

Figure 4. Typical output characteristics ($T_J = 175^\circ C$)

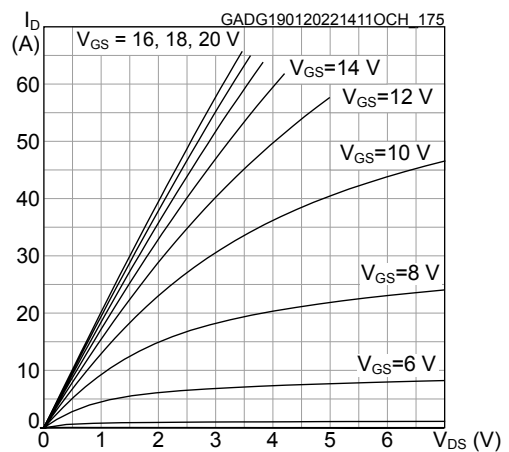

Figure 5. Typical transfer characteristics

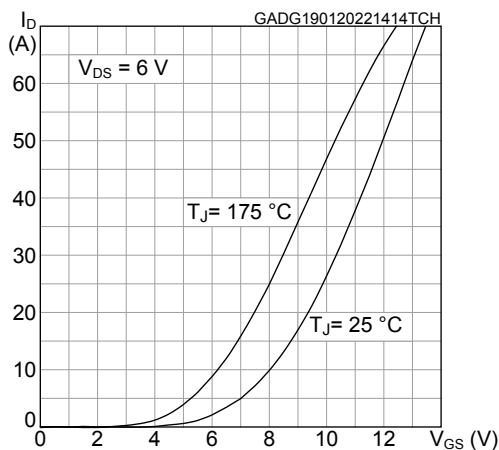

Figure 6. Total power dissipation

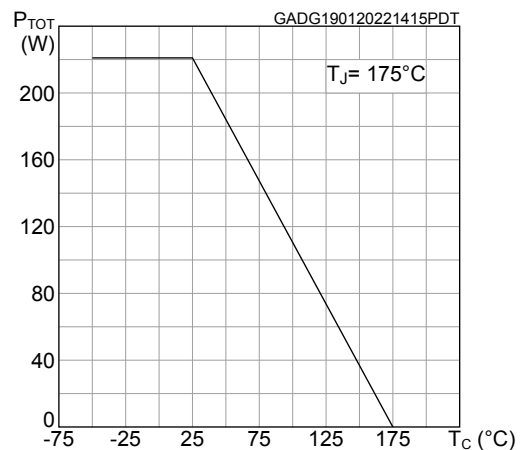

Figure 7. Typical gate charge characteristics

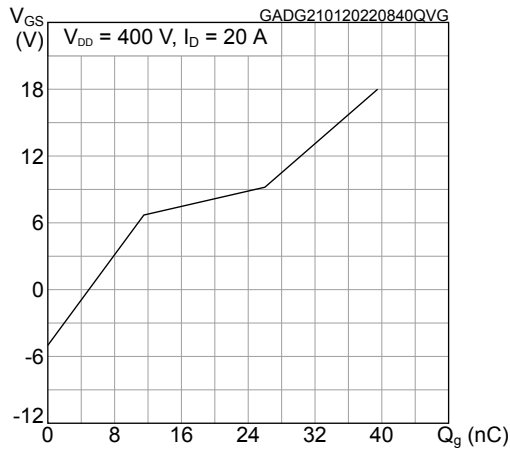

Figure 8. Typical capacitance characteristics

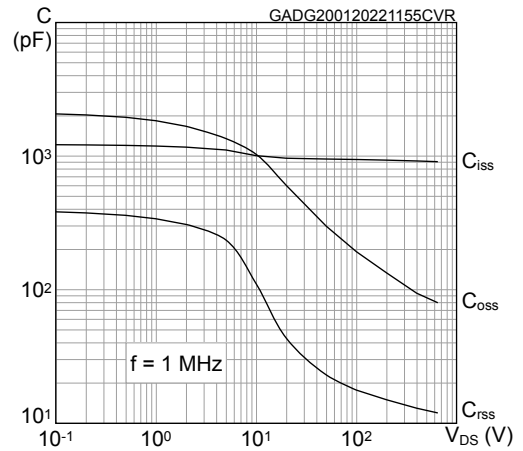

Figure 9. Typical switching energy vs drain current

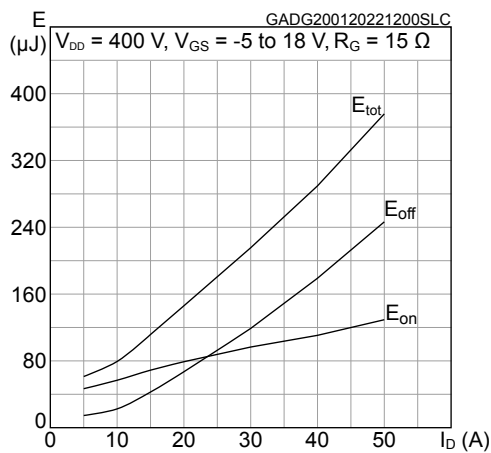

Figure 10. Typical switching energy vs gate resistance

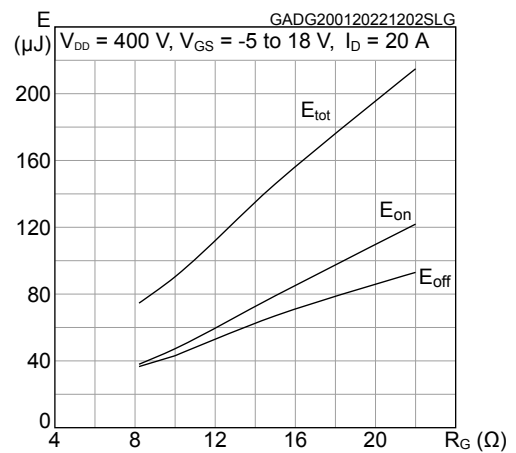

Figure 11. Normalized breakdown voltage vs temperature

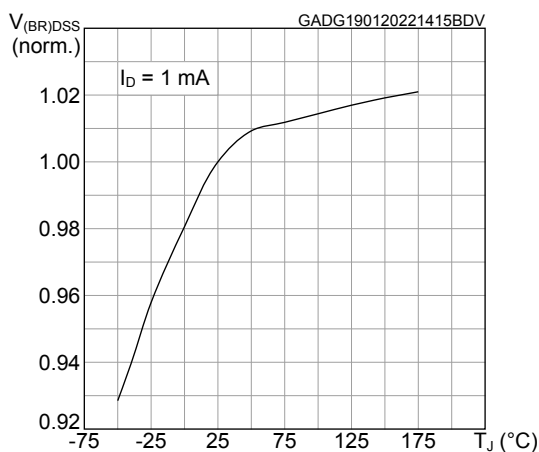

Figure 12. Normalized gate threshold vs temperature

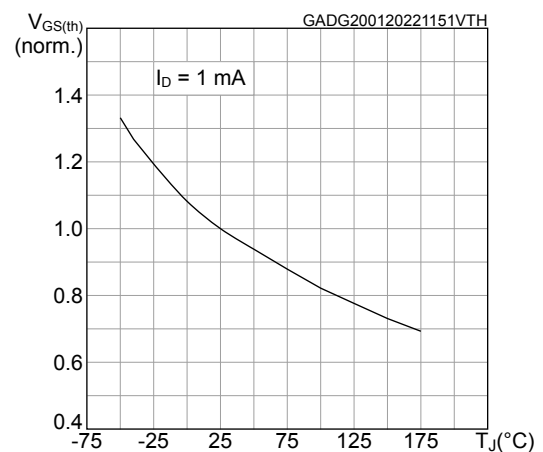

Figure 13. Normalized on-resistance vs temperature

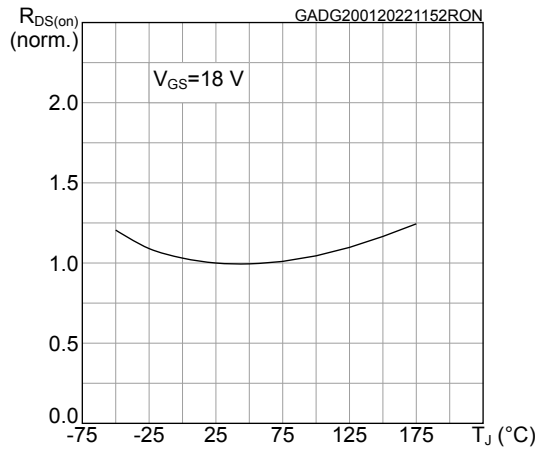

Figure 14. Typical reverse conduction characteristics ($T_J=25^\circ\text{C}$)

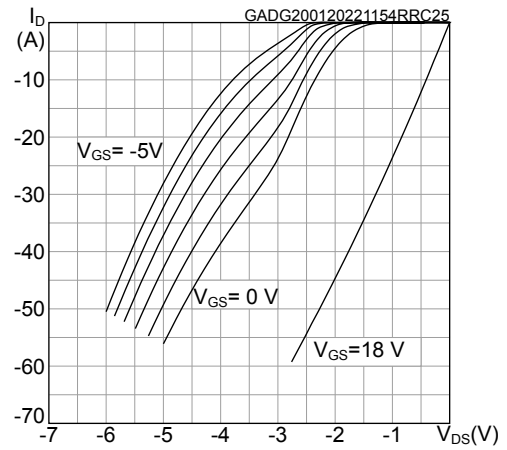
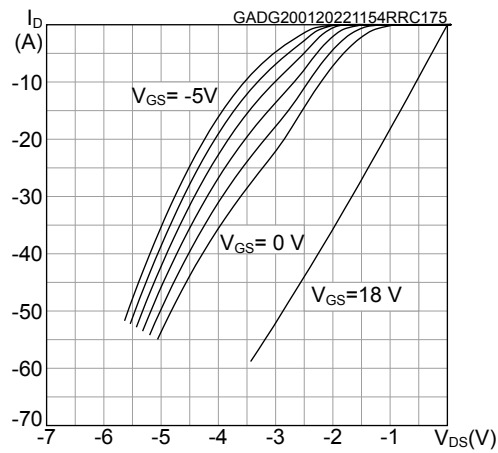

Figure 15. Typical reverse conduction characteristics ($T_J=175^\circ\text{C}$)



3 Package information

In order to meet environmental requirements, ST offers these devices in different grades of **ECOPACK** packages, depending on their level of environmental compliance. ECOPACK specifications, grade definitions and product status are available at: www.st.com. ECOPACK is an ST trademark.

3.1 HU3PAK package information

Figure 16. HU3PAK package outline

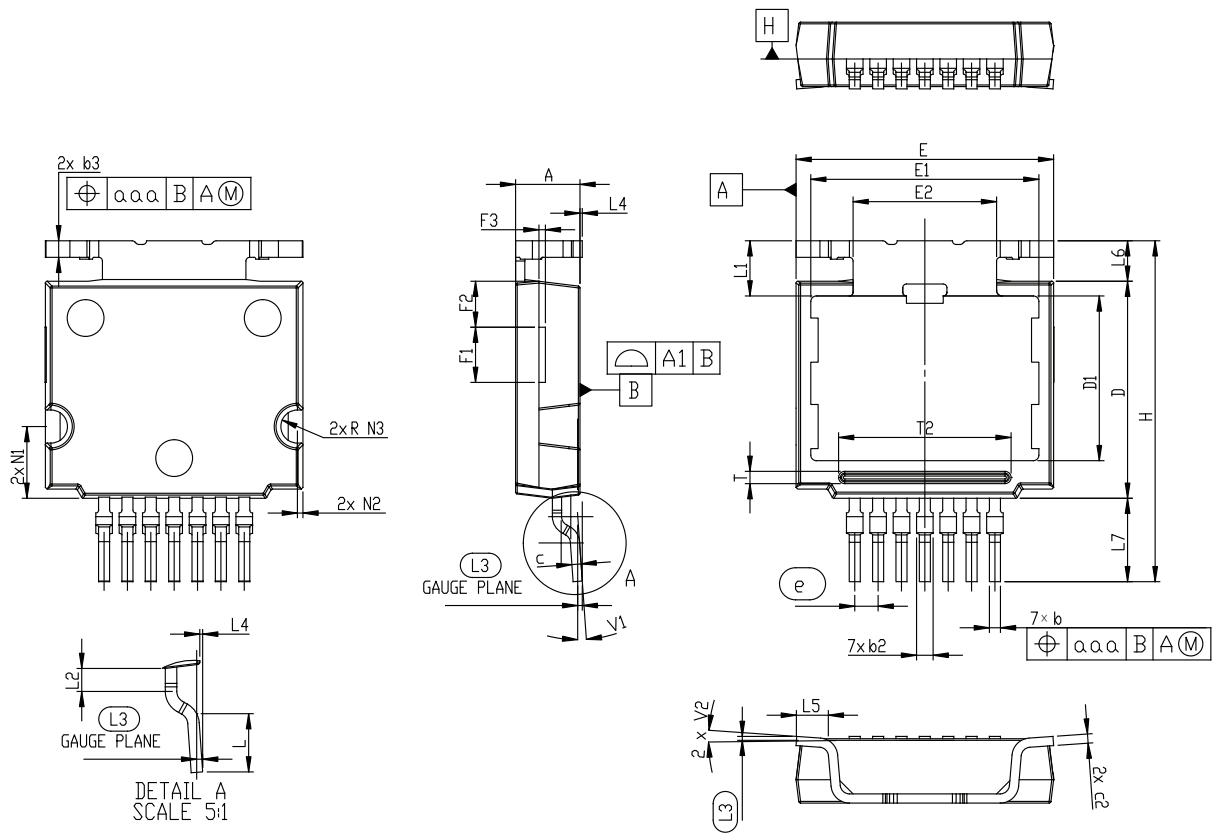

DM00674007_2

Table 8. HU3PAK package mechanical data

Ref.	Dimensions		
	mm		
	Min.	Typ.	Max.
A	3.40	3.50	3.60
A1		0.05	
b	0.50	0.60	0.70
b2	0.50	0.70	1.00
b3	0.80	0.90	1.00
c	0.40	0.50	0.60
c2	0.40	0.50	0.60
D	11.70	11.80	11.90
D1	8.80	8.955	9.10
E	13.90	14.00	14.10
E1	12.30	12.40	12.50
E2	7.75	7.80	7.85
e		1.27	
H	18.00	18.58	19.00
aaa		0.10	
L	2.40	2.52	2.60
L1		3.05	
L2	0.90	1.00	1.10
L3		0.26	
L4	0.075	0.125	0.175
L5	1.83	1.93	2.03
L6	2.14	2.24	2.34
L7	4.44	4.54	4.64
F1	2.90	3.00	3.10
F2	2.40	2.50	2.60
F3	0.25	0.35	0.45
N1	3.80	3.90	4.00
N2	0.25	0.30	0.45
N3	0.80	0.90	1.00
T	0.50	0.67	0.70
T2	9.18	9.38	9.43
V1		0°	8°
V2		0°	8°

Figure 17. HU3PAK recommended footprint (dimensions in mm)

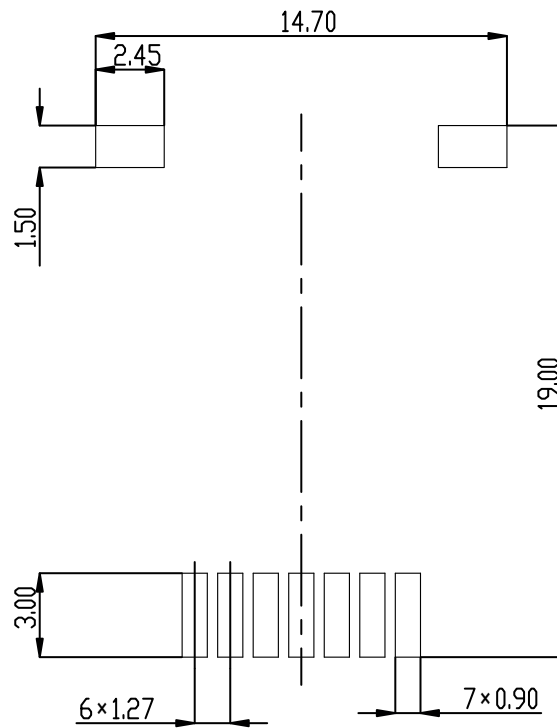

3.2 HU3PAK packing information

Figure 18. HU3PAK carrier tape outline

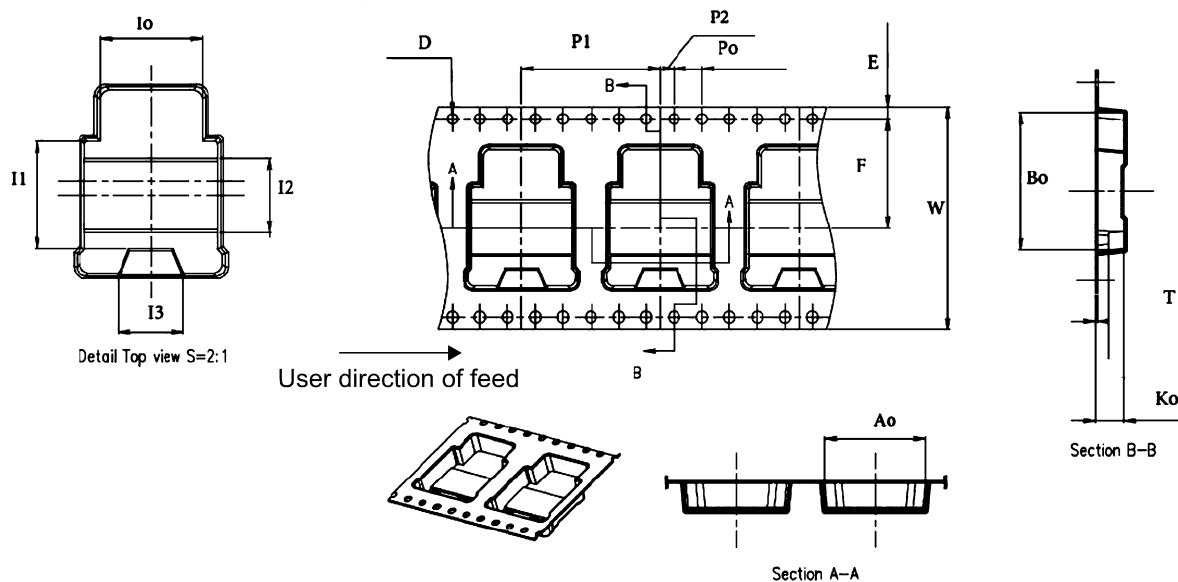

DM00345054_3

Table 9. HU3PAK tape mechanical data

Dimension	Value
	mm
A0	14.40 ±0.10
B0	19.70
D	1.50 ±0.10
E	1.75 ±0.10
F	15.65 ±0.10
I0	11.00
I1	11.60 ±0.10
I2	8.00
I3	7.00
K0	4.20
P0	4.00 ±0.10
P1	20.00 ±0.10
P2	2.00 ±0.10
T	0.40 ±0.50
W	32.00 ±0.30

Figure 19. HU3PAK reel outline

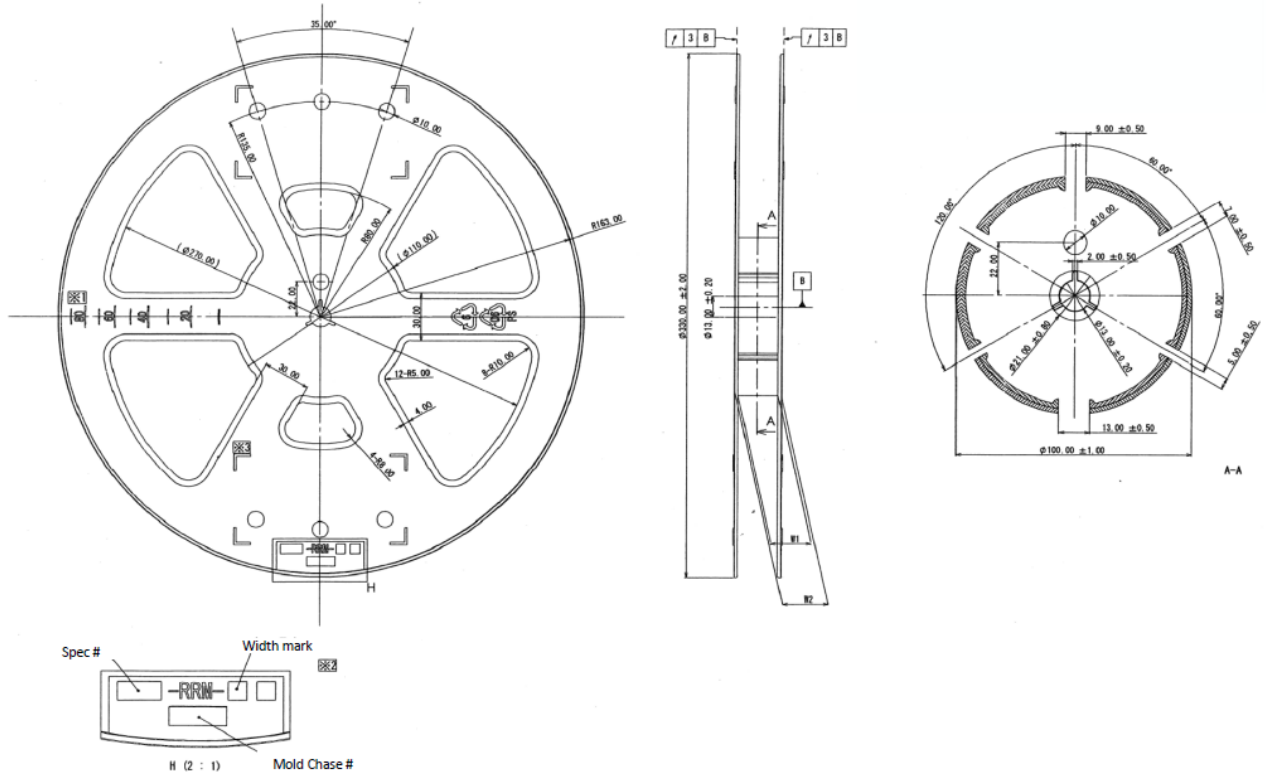

Table 10. HU3PAK reel mechanical data

Dimension	Value
	mm
Reel width	32.0
Reel inner width	33.4 ± 1.0
Reel outer width	37.4 ± 1.0

Revision history

Table 11. Document revision history

Date	Revision	Changes
21-Feb-2022	1	First release.
23-Mar-2022	2	Updated marking in Device summary . Minor text changes.

Contents

1	Electrical ratings	2
2	Electrical characteristics	3
2.1	Electrical characteristics (curves)	5
3	Package information	8
3.1	HU3PAK package information	8
3.2	HU3PAK packing information	11
	Revision history	13

IMPORTANT NOTICE – READ CAREFULLY

STMicroelectronics NV and its subsidiaries (“ST”) reserve the right to make changes, corrections, enhancements, modifications, and improvements to ST products and/or to this document at any time without notice. Purchasers should obtain the latest relevant information on ST products before placing orders. ST products are sold pursuant to ST’s terms and conditions of sale in place at the time of order acknowledgment.

Purchasers are solely responsible for the choice, selection, and use of ST products and ST assumes no liability for application assistance or the design of purchasers’ products.

No license, express or implied, to any intellectual property right is granted by ST herein.

Resale of ST products with provisions different from the information set forth herein shall void any warranty granted by ST for such product.

ST and the ST logo are trademarks of ST. For additional information about ST trademarks, refer to www.st.com/trademarks. All other product or service names are the property of their respective owners.

Information in this document supersedes and replaces information previously supplied in any prior versions of this document.

© 2022 STMicroelectronics – All rights reserved

X-ON Electronics

Largest Supplier of Electrical and Electronic Components

Click to view similar products for [SiC MOSFETs](#) category:

Click to view products by [STMicroelectronics](#) manufacturer:

Other Similar products are found below :

[NTC040N120SC1](#) [HC3M001K170J](#) [IMBG65R048M1HXTMA1](#) [IMW120R045M1](#) [SCTWA70N120G2V-4](#) [SCT040HU65G3AG](#)
[SCTWA90N65G2V](#) [GC3M0060065K](#) [GC3M0120090D](#) [GC3M0032120D](#) [GC3M0160120D](#) [GC3M0040120K](#) [GC3M0021120D](#)
[GC3M0065090D](#) [GC3M0032120K](#) [GC3M0065100K](#) [GC3M0075120K](#) [GC2M0040120D](#) [GC3M0280090D](#) [GC2M0025120D](#)
[GC3M0075120D](#) [GC3M0040120D](#) [GC2M0280120D](#) [GC2M0080120K](#) [GC3M0016120D](#) [GC2M0045170D](#) [GC2M0160120K](#)
[GC3M0021120K](#) [SP25N120CTK](#) [SP90N120CTK](#) [GC3M0080120K](#) [SP50N120CTK](#) [GC2M0160120D](#) [GC2M1000170D](#) [GC3M0120100K](#)
[GC2M0080120D](#) [SP50N120CTF](#) [SP35N120CTF](#) [SP25N120CTF](#) [IV2Q171R0D7](#) [IV1Q06040L1](#) [IV1Q06060T3G](#) [IV1Q12160T4](#)
[IV1B12013HA1L](#) [IV1Q12160T3](#) [IV1Q07015T4G](#) [IV1Q12750O3](#) [IV1Q06040T3](#) [IV1Q12050T4Z](#) [IV1Q12030T4G](#)