

600 W TVS in SMB

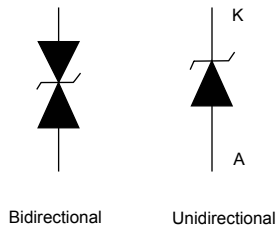

Features

- Peak pulse power: 600 W (10/1000 μ s) and 4 kW (8/20 μ s)
- Stand-off voltage range from 5 V to 188 V
- Unidirectional and bidirectional types
- Low leakage current: 0.2 μ A at 25 °C and 1 μ A at 85 °C
- Operating T_j max: 150 °C
- High power capability at T_j max.: up to 515 W (10/1000 μ s)
- Lead finishing: matte tin plating

Complies with the following standards

- UL94, V0
- J-STD-020 MSL level 1
- J-STD-002, JESD 22-B102 E3 and MIL-STD-750, method 2026 solderable matte tin plated leads
- JESD-201 class 2 whisker test
- IPC7531 footprint
- JEDEC registered package outline
- IEC 61000-4-4 level 4:
 - 4 kV
- IEC 61000-4-2, C = 150 pF - R = 330 Ω exceeds level 4:
 - 30 kV (air discharge)
 - 30 kV (contact discharge)

Description

The SM6T series are designed to protect sensitive equipment against electrostatic discharges according to IEC 61000-4-2 and MIL STD 883, method 3015, and electrical overstress according to IEC 61000-4-4 and 5. This device is more generally used against surges below 600 W (10/1000 μ s).

The Planar technology makes it suitable for high-end equipment and SMPS where low leakage current and high junction temperature are required to provide reliability and stability over time.

The SM6T series are packaged in SMB.

Product status link

Product status link	
SM6T	SM6T6V8A, SM6T6V8CA, SM6T7V5A, SM6T7V5CA, SM6T10A, SM6T10CA, SM6T12A, SM6T12CA, SM6T15A, SM6T15CA, SM6T18A, SM6T18CA, SM6T22A, SM6T22CA, SM6T24A, SM6T24CA, SM6T27A, SM6T27CA, SM6T30A, SM6T30CA, SM6T33A, SM6T33CA, SM6T36A, SM6T36CA, SM6T39A, SM6T39CA, SM6T56A, SM6T56CA, SM6T68A, SM6T68CA, SM6T75A, SM6T75CA, SM6T100A, SM6T100CA, SM6T150A, SM6T150CA, SM6T200A, SM6T200CA, SM6T220A, SM6T220CA

1 Characteristics

Table 1. Absolute maximum ratings ($T_{amb} = 25\text{ }^{\circ}\text{C}$)

Symbol	Parameter	Value	Unit	
V_{PP}	Peak pulse voltage	IEC 61000-4-2 (C = 150 pF, R = 330 Ω)		
		Contact discharge	30	kV
		Air discharge	30	
P_{PP}	Peak pulse power dissipation	10/1000 μs , T_j initial = T_{amb}	600	W
T_{stg}	Storage temperature range		-65 to +150	$^{\circ}\text{C}$
T_j	Operating junction temperature range		-55 to +150	$^{\circ}\text{C}$
T_L	Maximum lead temperature for soldering during 10 s		260	$^{\circ}\text{C}$

Figure 1. Electrical characteristics - parameter definitions

Figure 2. Pulse definition for electrical characteristics

Table 2. Electrical characteristics - parameter values ($T_{amb} = 25\text{ }^{\circ}\text{C}$, unless otherwise specified)

Type	I_{RM} max at V_{RM}			V_{BR} at I_{BR} ⁽¹⁾				10 / 1000 μs			8 / 20 μs			αT
								V_{CL} ⁽²⁾⁽³⁾	I_{PP} ⁽⁴⁾	R_D	V_{CL} ⁽²⁾⁽³⁾	I_{PP} ⁽⁴⁾	R_D	Max.
	25 $^{\circ}\text{C}$	85 $^{\circ}\text{C}$		Min.	Typ.	Max.		Max.						
	μA	V		V			mA	V	A	Ω	V	A	Ω	$10^{-4}/^{\circ}\text{C}$
SM6T6V8A/CA	20	50	5.80	6.45	6.8	7.14	10	10.5	57	0.059	14.4	275	0.027	5.7
SM6T7V5A/CA	20	50	6.40	7.13	7.5	7.88	10	11.3	53	0.065	15.2	266	0.027	6.1
SM6T10A/CA	20	50	8.55	9.5	10.0	10.5	1	14.5	41	0.098	18.6	215	0.038	7.3
SM6T12A/CA	0.2	1	10.2	11.4	12	12.6	1	16.7	36	0.114	21.7	184	0.049	7.8
SM6T15A/CA	0.2	1	12.8	14.3	15	15.8	1	21.2	28	0.193	27.2	147	0.078	8.4
SM6T18A/CA	0.2	1	15.3	17.1	18	18.9	1	25.2	24	0.263	32.5	123	0.111	8.8
SM6T22A/CA	0.2	1	18.8	20.9	22	23.1	1	30.6	20	0.375	39.3	102	0.159	9.2
SM6T24A/CA	0.2	1	20.5	22.8	24	25.2	1	33.2	18	0.444	42.8	93	0.189	9.4
SM6T27A/CA	0.2	1	23.1	25.7	27	28.4	1	37.5	16	0.569	48.3	83	0.240	9.6
SM6T30A/CA	0.2	1	25.6	28.5	30	31.5	1	41.5	14.5	0.690	53.5	75	0.293	9.7
SM6T33A/CA	0.2	1	28.2	31.4	33	34.7	1	45.7	13.1	0.840	59.0	68	0.357	9.8
SM6T36A/CA	0.2	1	30.8	34.2	36	37.8	1	49.9	12	1.01	64.3	62	0.427	9.9
SM6T39A/CA	0.2	1	33.3	37.1	39	41.0	1	53.9	11.1	1.16	69.7	57	0.504	10.0
SM6T56A/CA	0.2	1	47.6	53.2	56	58.8	1	76.6	7.8	2.28	100	40	1.030	10.0
SM6T68A/CA	0.2	1	58.1	64.6	68	71.4	1	92	6.5	3.17	121	33	1.503	10.4
SM6T75A/CA	0.2	1	64.1	71.3	75	78.8	1	103	5.8	4.17	134	30	1.84	10.5
SM6T100A/CA	0.2	1	85.5	95.0	100	105	1	137	4.4	7.27	178	22.5	3.24	10.6
SM6T150A/CA	0.2	1	128	143	150	158	1	207	2.9	16.9	265	15	7.13	10.8
SM6T200A/CA	0.2	1	171	190	200	210	1	274	2.2	29.1	353	11.3	12.7	10.8
SM6T220A/CA	0.2	1	188	209	220	231	1	328	2	48.5	388	10.3	15.2	10.8

1. To calculate V_{BR} versus T_j : V_{BR} at $T_j = V_{BR}$ at $25\text{ }^{\circ}\text{C} \times (1 + \alpha T \times (T_j - 25))$
2. To calculate V_{CL} versus T_j : V_{CL} at $T_j = V_{CL}$ at $25\text{ }^{\circ}\text{C} \times (1 + \alpha T \times (T_j - 25))$
3. To calculate V_{CL} max versus $I_{PPappli}$: $V_{CLmax} = V_{BR}$ max + $R_D \times I_{PPappli}$
4. Surge capability given for both directions for unidirectional and bidirectional devices

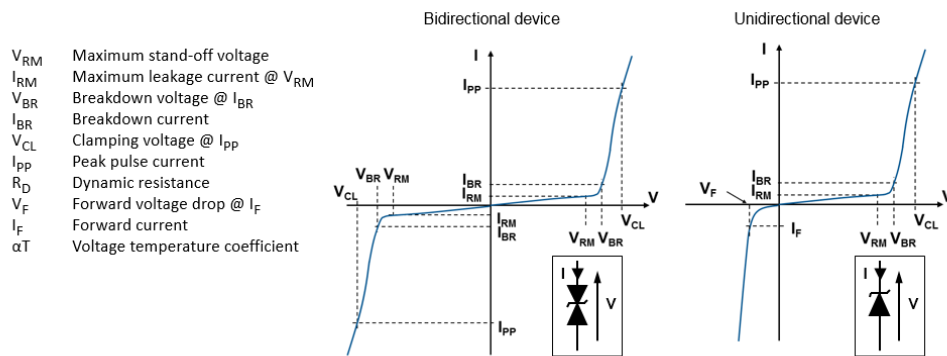
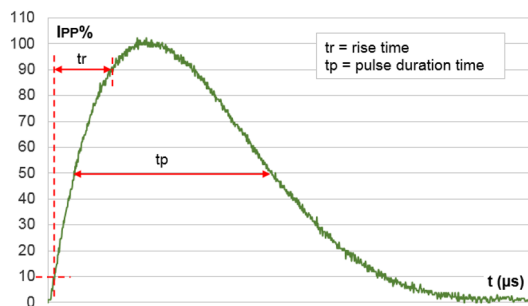
1.1 Characteristics (curves)

Figure 3. Maximum peak power dissipation versus initial junction temperature

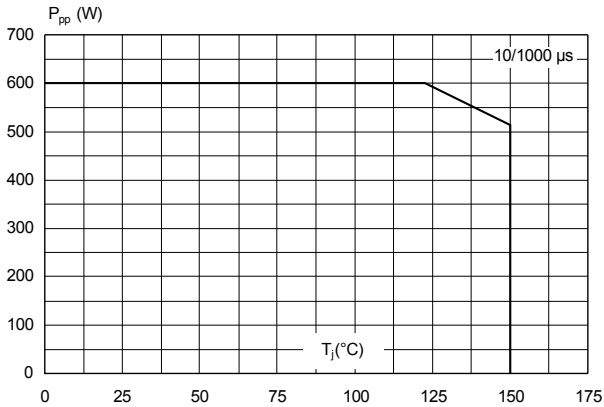

Figure 4. Maximum peak pulse power versus exponential pulse duration

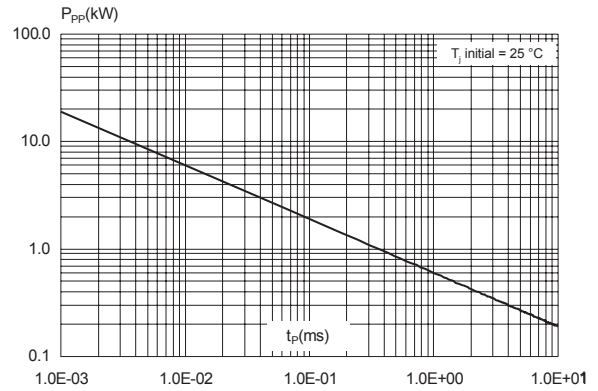

Figure 5. Maximum peak pulse current versus clamping voltage

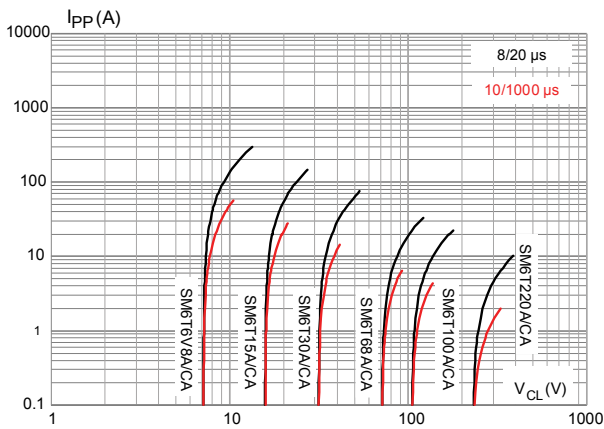

Figure 6. Dynamic resistance versus pulse duration (typical values)

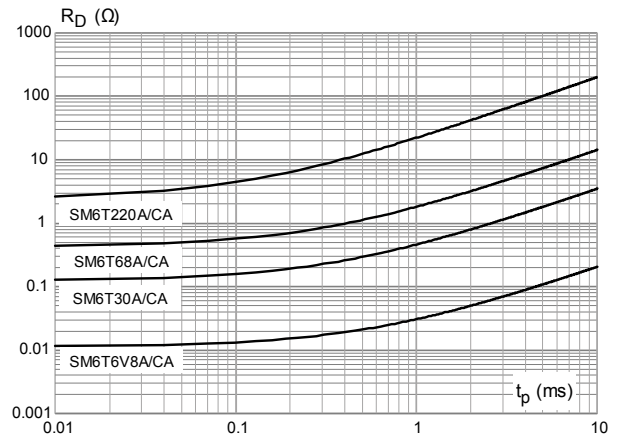

Figure 7. Junction capacitance versus reverse applied voltage (unidirectional types)

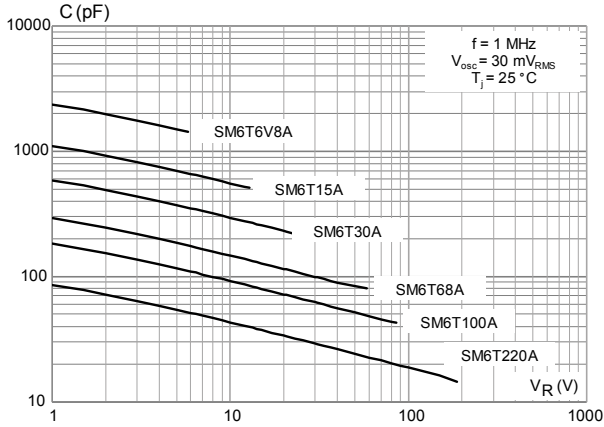

Figure 8. Junction capacitance versus applied voltage (bidirectional type)

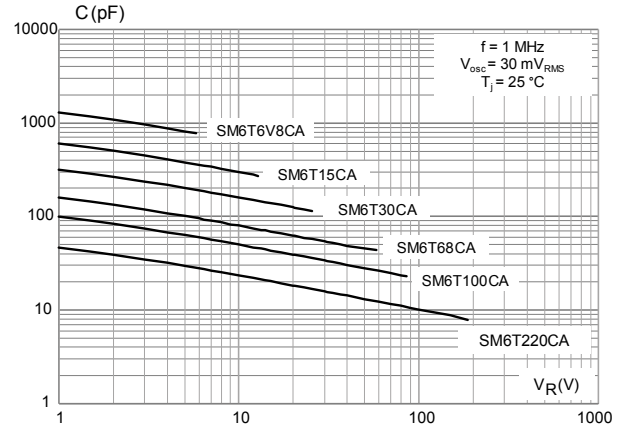

Figure 9. Leakage current versus junction temperature

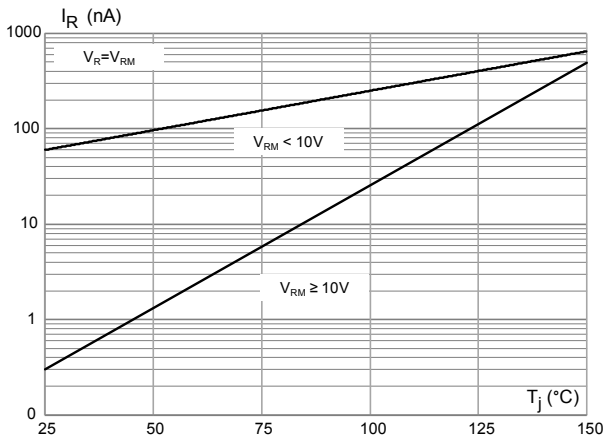

Figure 10. Peak forward voltage drop versus peak forward current

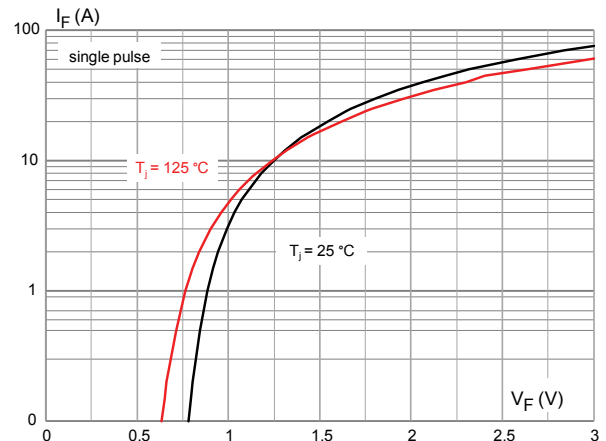

Figure 11. Thermal impedance junction to ambient versus pulse duration

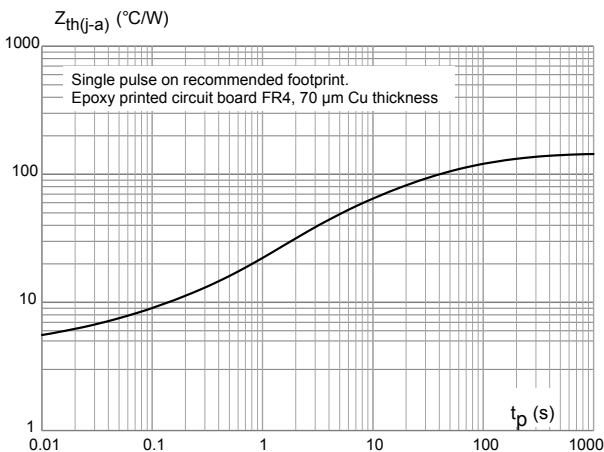
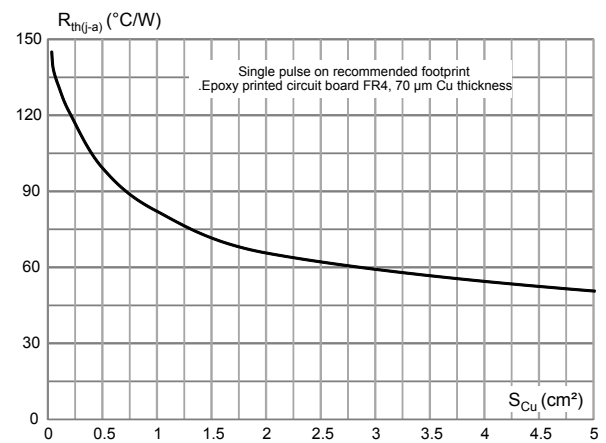

Figure 12. Thermal resistance junction to ambient versus copper area under each lead



2 Package information

In order to meet environmental requirements, ST offers these devices in different grades of **ECOPACK** packages, depending on their level of environmental compliance. ECOPACK specifications, grade definitions and product status are available at: www.st.com. ECOPACK is an ST trademark.

2.1 SMB package information

Figure 13. SMB package outline

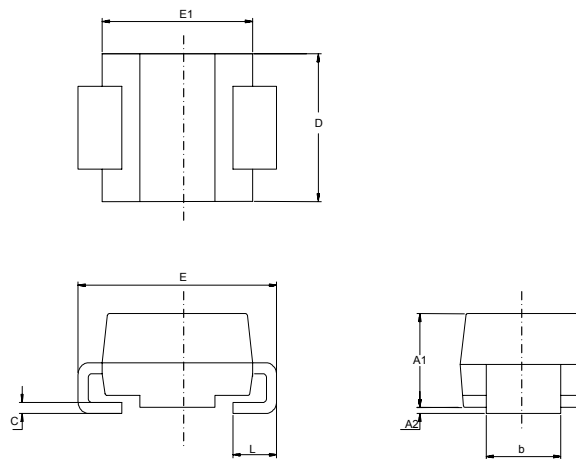

Table 3. SMB package mechanical data

Ref.	Dimensions			
	Millimeters		Inches ⁽¹⁾	
	Min.	Max.	Min.	Max.
A1	1.90	2.45	0.0748	0.0965
A2	0.05	0.20	0.0020	0.0079
b	1.95	2.20	0.0768	0.0867
c	0.15	0.40	0.0059	0.0157
D	3.30	3.95	0.1299	0.1556
E	5.10	5.60	0.2008	0.2205
E1	4.05	4.60	0.1594	0.1811
L	0.75	1.50	0.0295	0.0591

1. Values in inches are converted from mm

Figure 14. SMB recommended footprint

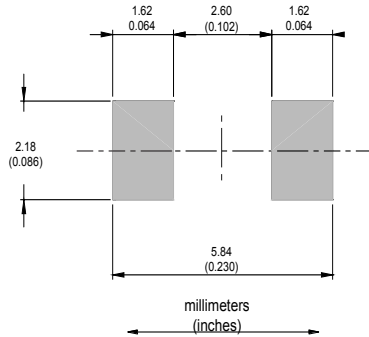

Figure 15. Marking layout

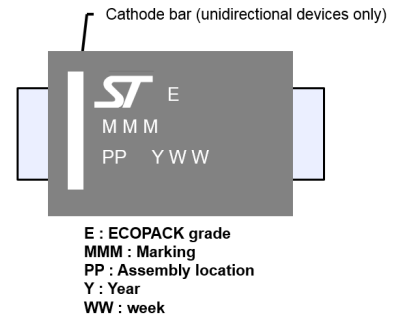
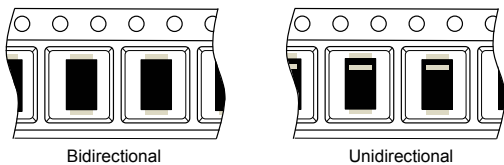

Figure 16. Package orientation in reel



Taped according to EIA-481
Pocket dimensions are not on scale.
Pocket shape may vary depending on package
On bidirectional devices, marking and logo may not be always in the same direction.

Figure 17. Tape and reel orientation

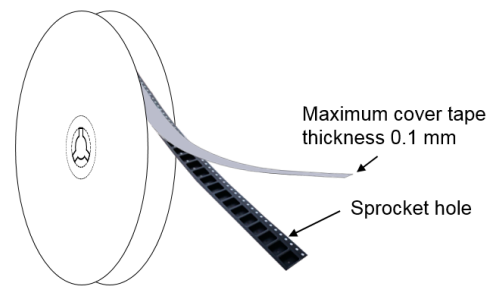

Figure 18. Reel dimensions (mm)

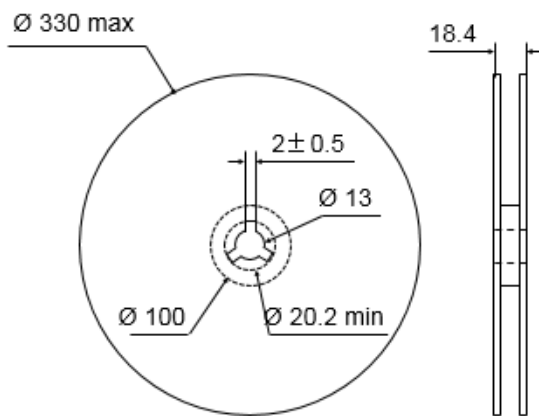

Figure 19. Inner box dimensions (mm)

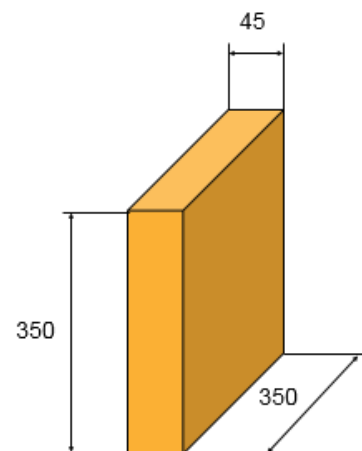
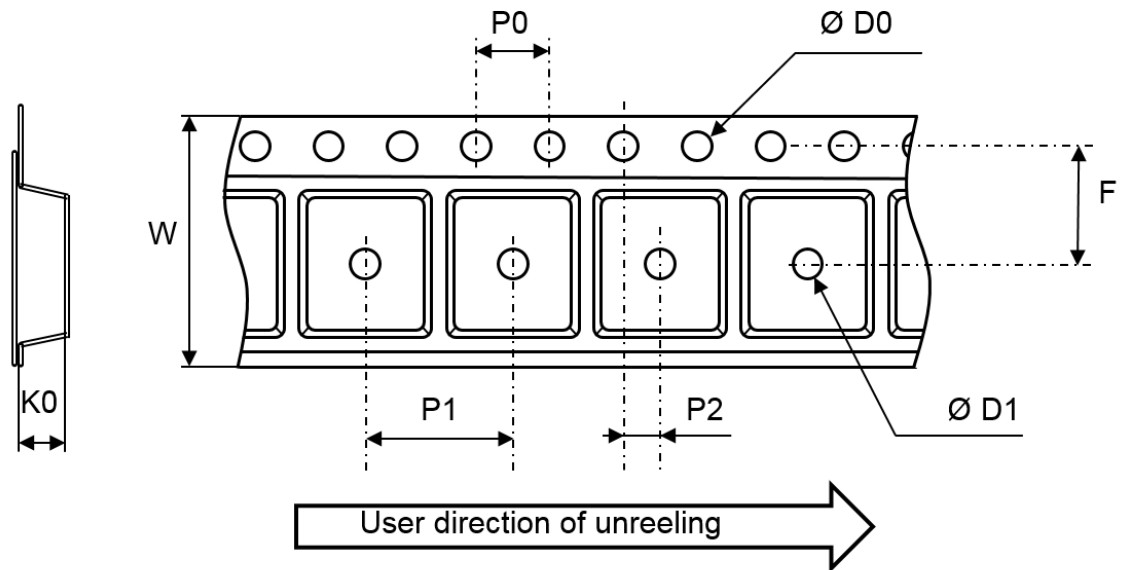

Figure 20. Tape and reel outline



Note: Pocket dimensions are not on scale
Pocket shape may vary depending on package

Table 4. Tape and reel mechanical data

Ref.	Dimensions		
	Millimeters		
	Min.	Typ.	Max.
ØD0	1.5	1.55	1.6
ØD1	1.5		
F	5.4	5.5	5.6
K0	2.64	2.74	2.84
P0	3.9	4.0	4.1
P1	7.9	8.0	8.1
P2	1.9	2.0	2.1
W	11.7	12.0	12.3

2.2 Reflow profile

Figure 21. ST ECOPACK recommended soldering reflow profile for PCB mounting

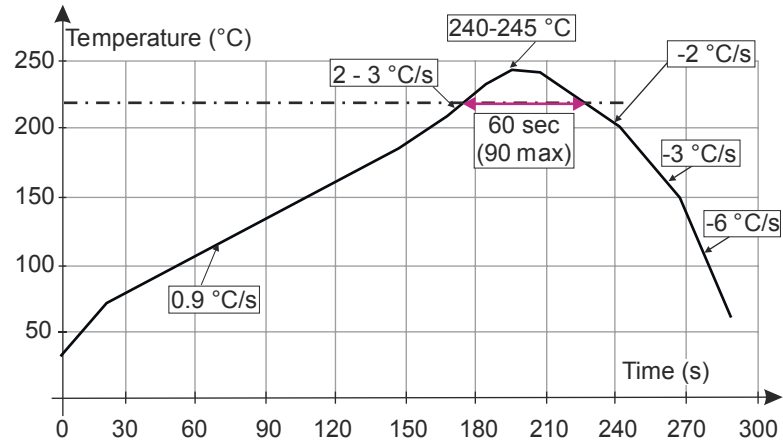

Note: Minimize air convection currents in the reflow oven to avoid component movement. Maximum soldering profile corresponds to the latest IPC/JEDEC J-STD-020.

3 Ordering information

Figure 22. Ordering information scheme

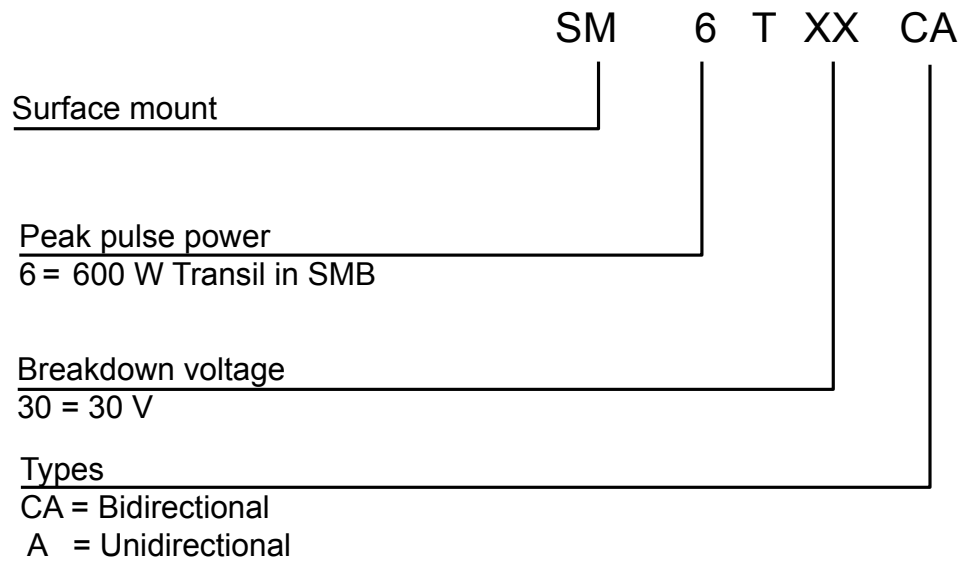

Table 5. Ordering information

Order code	Marking	Package	Weight	Base qty.	Delivery mode
SM6TxxxA / CA	See Table 6. Marking	SMB	0.11 g	2500	Tape and reel

Table 6. Marking

Order code	Marking	Order code	Marking
SM6T6V8A	DE	SM6T6V8CA	LE
SM6T7V5A	DG	SM6T7V5CA	LG
SM6T10A	DP	SM6T10CA	LP
SM6T12A	DT	SM6T12CA	LT
SM6T15A	DX	SM6T15CA	LX
SM6T18A	EE	SM6T18CA	ME
SM6T22A	EK	SM6T22CA	MK
SM6T24A	EM	SM6T24CA	MM
SM6T27A	EP	SM6T27CA	MP
SM6T30A	ER	SM6T30CA	MR
SM6T33A	ET	SM6T33CA	MT
SM6T36A	EV	SM6T36CA	MV
SM6T39A	EX	SM6T39CA	MX
SM6T56A	FL	SM6T56CA	NL
SM6T68A	FQ	SM6T68CA	NQ
SM6T75A	FS	SM6T75CA	NS
SM6T100A	FY	SM6T100CA	NY
SM6T150A	GL	SM6T150CA	OL
SM6T200A	GU	SM6T200CA	OU
SM6T220A	GW	SM6T220CA	OW

Revision history

Table 7. Document revision history

Date	Version	Changes
Aug-2001	4	Previous update.
15-Sep-2004	5	1. Types table parameters on page 2: IRM @ T _j = 85 °C condition added 2. IRM max values changed
26-Mar-2009	6	Reformatted to current standard. SMB dimensions and footprint updated. Maximum junction temperature replaced with operating junction temperature range in Table 1.
25-May-2009	7	Reformatted to current standard. Added standards compliance information on page 1. Added device SM6T56 to Table 3. Updated all characteristic curves.
17-Sep-2009	8	Document updated for low leakage current.
20-Oct-2009	9	Updated Figure 13.
10-Jan-2018	10	Updated Table 3: "Electrical characteristics parameter values (T _{amb} = 25 °C, unless otherwise specified)".
03-Sep-2020	11	Updated Section 1.1 Characteristics (curves).
11-Sep-2020	12	Minor text change.
02-Jun-2021	13	Updated Figure 12 .

IMPORTANT NOTICE – PLEASE READ CAREFULLY

STMicroelectronics NV and its subsidiaries (“ST”) reserve the right to make changes, corrections, enhancements, modifications, and improvements to ST products and/or to this document at any time without notice. Purchasers should obtain the latest relevant information on ST products before placing orders. ST products are sold pursuant to ST’s terms and conditions of sale in place at the time of order acknowledgement.

Purchasers are solely responsible for the choice, selection, and use of ST products and ST assumes no liability for application assistance or the design of Purchasers’ products.

No license, express or implied, to any intellectual property right is granted by ST herein.

Resale of ST products with provisions different from the information set forth herein shall void any warranty granted by ST for such product.

ST and the ST logo are trademarks of ST. For additional information about ST trademarks, please refer to www.st.com/trademarks. All other product or service names are the property of their respective owners.

Information in this document supersedes and replaces information previously supplied in any prior versions of this document.

© 2021 STMicroelectronics – All rights reserved

X-ON Electronics

Largest Supplier of Electrical and Electronic Components

Click to view similar products for [ESD Suppressors / TVS Diodes](#) category:

Click to view products by [STMicroelectronics](#) manufacturer:

Other Similar products are found below :

[60KS200C](#) [D12V0H1U2WS-7](#) [D18V0L1B2LP-7B](#) [82356050220](#) [D5V0M5U6V-7](#) [NTE4902](#) [P4KE27CA](#) [P6KE11CA](#) [P6KE39CA-TP](#)
[P6KE8.2A](#) [SA110CA](#) [SA60CA](#) [SA64CA](#) [SMBJ12CATR](#) [SMBJ8.0A](#) [SMLJ30CA-TP](#) [ESD101-B1-02ELS E6327](#) [ESD112-B1-02EL E6327](#)
[ESD119B1W01005E6327XTSA1](#) [ESD5V0J4-TP](#) [ESD5V0L1B02VH6327XTSA1](#) [ESD7451N2T5G](#) [19180-510](#) [CPDT-5V0USP-HF](#)
[3.0SMCJ33CA-F](#) [3.0SMCJ36A-F](#) [HSPC16701B02TP](#) [D3V3Q1B2DLP3-7](#) [D55V0M1B2WS-7](#) [DESD5V0U1BL-7B](#) [DRTR5V0U4SL-7](#)
[SCM1293A-04SO](#) [ESD200-B1-CSP0201 E6327](#) [ESD203-B1-02EL E6327](#) [SM12-7](#) [SMF8.0A-TP](#) [SMLJ45CA-TP](#) [CEN955 W/DATA](#)
[82350120560](#) [82356240030](#) [VESD12A1A-HD1-GS08](#) [CPDUR5V0R-HF](#) [CPDUR24V-HF](#) [CPDQC5V0U-HF](#) [CPDQC5V0USP-HF](#)
[CPDQC5V0-HF](#) [D1213A-01LP4-7B](#) [D1213A-02WL-7](#) [ESDLIN1524BJ-HQ](#) [5KP100A](#)