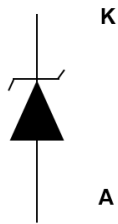
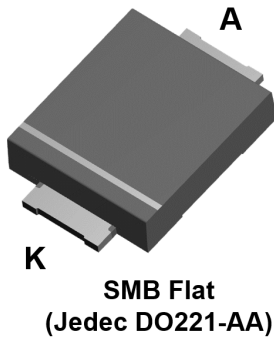


## 1500 W TVS in SMB Flat



Unidirectional

Product status link

SMB15FxxA series

SMB15F5.0A, SMB15F6.0A,  
SMB15F6.5A, SMB15F8.5A,  
SMB15F10A, SMB15F11A, SMB15F13A,  
SMB15F12A, SMB15F14A, SMB15F15A,  
SMB15F16A, SMB15F18A, SMB15F20A,  
SMB15F22A, SMB15F23A, SMB15F24A,  
SMB15F26A, SMB15F28A, SMB15F30A,  
SMB15F31A, SMB15F33A, SMB15F36A,  
SMB15F40A, SMB15F48A, SMB15F58A,  
SMB15F64A

### Features

- Peak pulse power: 1500 W (10/1000  $\mu$ s) and 10 kW (8/20  $\mu$ s)
- Flat and thin package: 1 mm
- Stand-off voltage range: from 5 V to 64 V
- Unidirectional type
- Low leakage current: 0.2  $\mu$ A at 25 °C and 1  $\mu$ A at 85 °C
- Operating  $T_j$  max: 175 °C
- High power capability at  $T_j$  max.: 1100 W (10/1000  $\mu$ s)
- Lead finishing: matte tin plating

### Complies with the following standards

- UL94, V0
- J-STD-020 MSL level 1
- J-STD-002, JESD 22-B102 E3 and MIL-STD-750, method 2026 solderable matte tin plated leads
- JESD-201 class 2 whisker test
- IPC7531 footprint
- JEDEC registered package outline
- IEC 61000-4-4 level 4:
  - 4 kV
- IEC 61000-4-2, C = 150 pF - R = 330  $\Omega$  exceeds level 4:
  - 30 kV (air discharge)
  - 30 kV (contact discharge)

### Description

The SMB15FxxA series are designed to protect sensitive circuits against surges.

The Planar technology makes it compatible with high-end circuits where low leakage current and high junction temperature are required to provide long term reliability and stability.

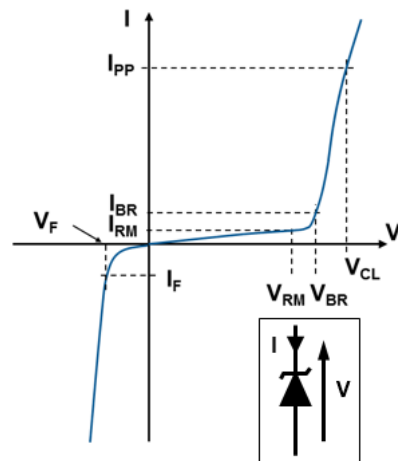
# 1 Characteristics

**Table 1. Absolute maximum ratings ( $T_{amb} = 25\text{ }^{\circ}\text{C}$ )**

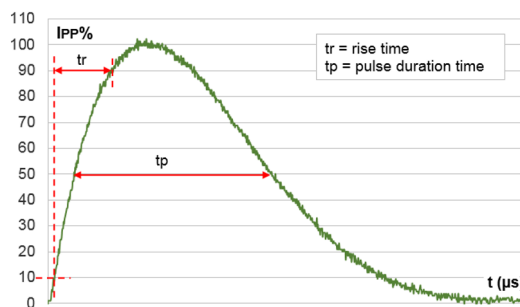
Symbol	Parameter	Value	Unit	
$V_{PP}$	Peak pulse voltage	IEC 61000-4-2 (C = 150 pF, R = 330 $\Omega$ )	kV	
		Contact discharge		30
		Air discharge		30
$P_{PP}$	Peak pulse power dissipation	10/1000 $\mu\text{s}$ , $T_j$ initial = $T_{amb}$	1500	W
$T_{stg}$	Storage temperature range		-65 to +175	$^{\circ}\text{C}$
$T_j$	Operating junction temperature range		-55 to +175	$^{\circ}\text{C}$
$T_L$	Maximum lead temperature for soldering during 10 s		260	$^{\circ}\text{C}$

**Figure 1. Electrical characteristics - parameter definitions**

- $V_{RM}$  Maximum stand-off voltage
- $I_{RM}$  Maximum leakage current @  $V_{RM}$
- $V_R$  Stand-off voltage
- $I_R$  Leakage current @  $V_R$
- $V_{BR}$  Breakdown voltage @  $I_{BR}$
- $I_{BR}$  Breakdown current
- $V_{CL}$  Clamping voltage @  $I_{PP}$
- $I_{PP}$  Peak pulse current
- $R_D$  Dynamic resistance
- $V_F$  Forward voltage drop @  $I_F$
- $I_F$  Forward current
- $\alpha T$  Voltage temperature coefficient



**Figure 2. Pulse definition for electrical characteristics**



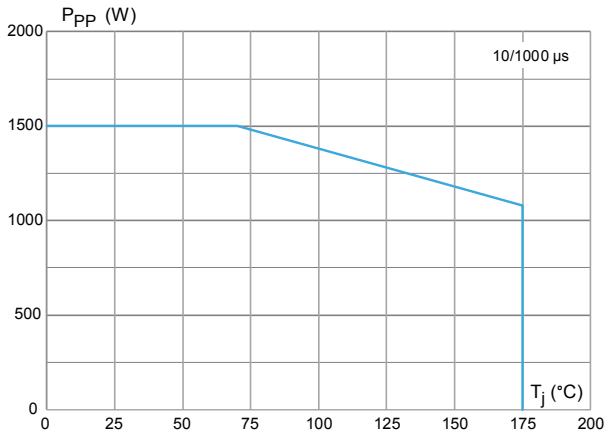
**Table 2. Electrical characteristics - parameter values (T<sub>amb</sub> = 25 °C, unless otherwise specified)**

Type	I <sub>RM</sub> max at V <sub>RM</sub>			V <sub>BR</sub> at I <sub>BR</sub> <sup>(1)</sup>				10 / 1000 μs			8 / 20μs			αT
								V <sub>CL</sub> <sup>(2)(3)</sup>	I <sub>PP</sub> <sup>(4)</sup>	R <sub>D</sub>	V <sub>CL</sub> <sup>(2)(3)</sup>	I <sub>PP</sub> <sup>(4)</sup>	R <sub>D</sub>	
	25 °C	85 °C		Min.	Typ.	Max.		Max.		Max.	Max.		Max.	
	μA		V	V			mA	V	A	Ω	V	A	Ω	10 <sup>-4</sup> /°C
SMB15F5.0A	20	50	5.0	6.4	6.74	7.1	10	9.2	171	0.012	13.4	746	0.008	5.7
SMB15F6.0A	20	50	6.0	6.7	7.05	7.4	10	10.3	152	0.019	13.7	730	0.009	5.9
SMB15F6.5A	20	50	6.5	7.2	7.58	8	10	11.2	140	0.023	14.5	690	0.009	6.1
SMB15F8.5A	20	50	8.5	9.4	9.9	10.4	1	14.4	105	0.038	19.5	512	0.018	7.3
SMB15F10A	0.2	1	10	11.1	11.7	12.3	1	17	92	0.051	21.7	461	0.020	7.8
SMB15F11A	0.2	1	11	12.3	13	13.7	1	18	85	0.051	24.2	413	0.025	8.1
SMB15F12A	0.2	1	12	13.3	14	14.7	1	19.9	79	0.066	25.3	394	0.027	8.3
SMB15F13A	0.2	1	13	14.4	15.2	16	1	21.5	73	0.075	27.2	368	0.030	8.4
SMB15F14A	0.2	1	14	15.7	16.5	17.3	1	23.1	67	0.087	29	338	0.035	8.6
SMB15F15A	0.2	1	15	16.7	17.6	18.5	1	24.4	64	0.092	32.5	308	0.045	8.8
SMB15F16A	0.2	1	16	17.9	18.8	19.8	1	26	58	0.107	34.7	293	0.049	9.0
SMB15F18A	0.2	1	18	20	21.1	22.2	1	29.2	53	0.132	39.3	254	0.067	9.2
SMB15F20A	0.2	1	20	22.2	23.4	24.6	1	32.4	48	0.163	42.8	234	0.078	9.4
SMB15F22A	0.2	1	22	24.4	25.7	27	1	35.5	44	0.193	48.3	207	0.103	9.6
SMB15F23A	0.2	1	23	25.7	27	28.4	1	37.8	41	0.229	49.2	202	0.103	9.6
SMB15F24A	0.2	1	24	26.7	28.1	29.5	1	38.9	40	0.235	50	200	0.103	9.6
SMB15F26A	0.2	1	26	28.9	30.4	31.9	1	42.1	37	0.276	53.5	187	0.116	9.7
SMB15F28A	0.2	1	28	31.1	32.7	34.3	1	45.4	34	0.326	59	169	0.146	9.8
SMB15F30A	0.2	1	30	33.2	35	36.8	1	48.4	32	0.363	64.3	156	0.176	9.9
SMB15F31A	0.2	1	31	34.2	36	37.8	1	50.2	31	0.400	65	153	0.178	9.9
SMB15F33A	0.2	1	33	36.7	38.6	40.5	1	53.3	29	0.441	69.7	143	0.204	10
SMB15F36A	0.2	1	36	40	42.1	44.2	1	58.1	26	0.539	76	131	0.243	10
SMB15F40A	0.2	1	40	44.4	46.7	49	1	64.5	24	0.646	84	119	0.294	10.1
SMB15F48A	0.2	1	48	53.2	56	58.8	1	77.4	20	0.930	100	100	0.412	10.3
SMB15F58A	0.2	1	58	64.6	68	71.4	1	93.6	16	1.39	121	83	0.598	10.4
SMB15F64A	0.2	1	64	71.1	74.8	78.6	1	103	14.6	1.66	134	75	0.74	10.5

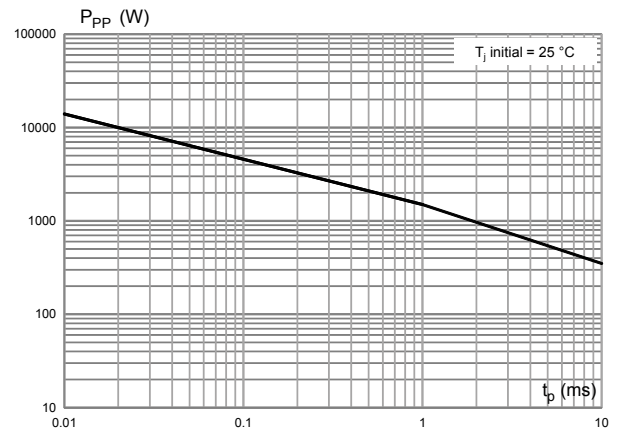
1. To calculate V<sub>BR</sub> versus T<sub>j</sub>: V<sub>BR</sub> at T<sub>j</sub> = V<sub>BR</sub> at 25 °C x (1 + αT x (T<sub>j</sub> - 25))
2. To calculate V<sub>CL</sub> versus T<sub>j</sub>: V<sub>CL</sub> at T<sub>j</sub> = V<sub>CL</sub> at 25 °C x (1 + αT x (T<sub>j</sub> - 25))
3. To calculate V<sub>CL</sub> max versus I<sub>PPappli</sub>: V<sub>CLmax</sub> = V<sub>BR</sub> max + RD x I<sub>PPappli</sub>
4. Surge capability given for both directions

## 1.1 Characteristics (curves)

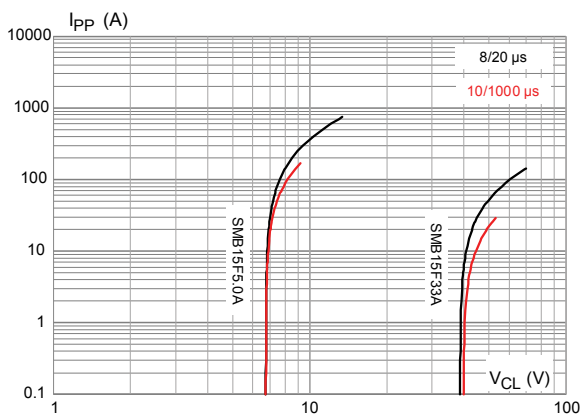
**Figure 3. Maximum peak power dissipation versus initial junction temperature**



**Figure 4. Maximum peak pulse power versus exponential pulse duration**



**Figure 5. Maximum peak pulse current versus clamping voltage**



**Figure 6. Dynamic resistance versus pulse duration**

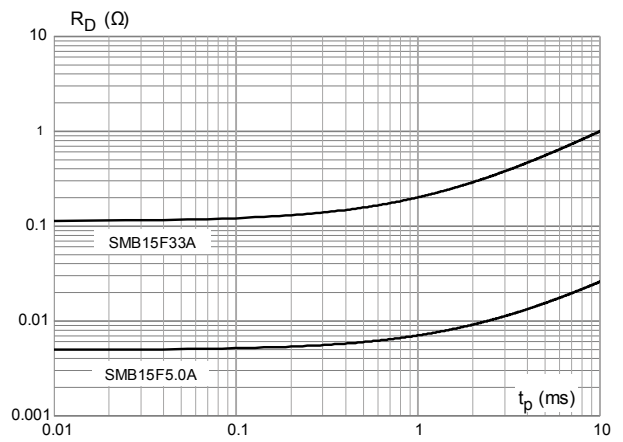


Figure 7. Junction capacitance versus reverse applied voltage (unidirectional types)

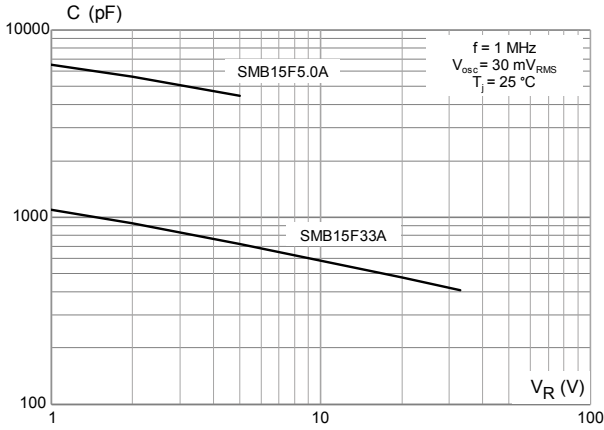


Figure 8. Leakage current versus junction temperature

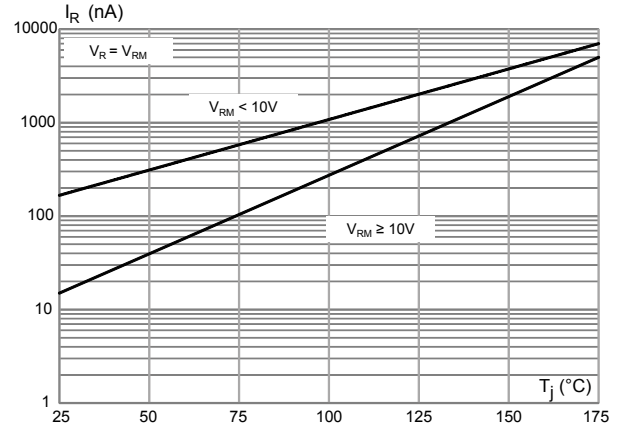


Figure 9. Peak forward voltage drop versus peak forward current

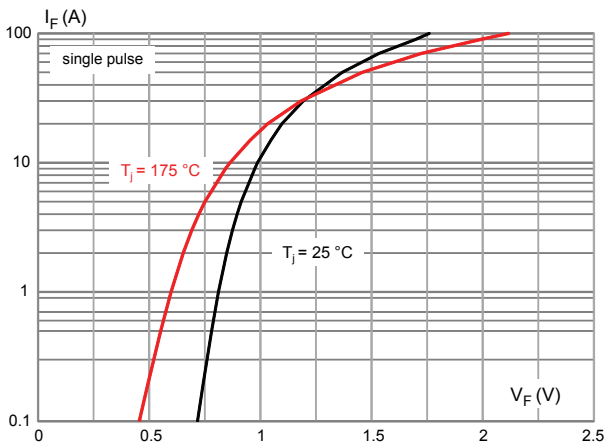


Figure 10. Thermal impedance junction to ambient versus pulse duration

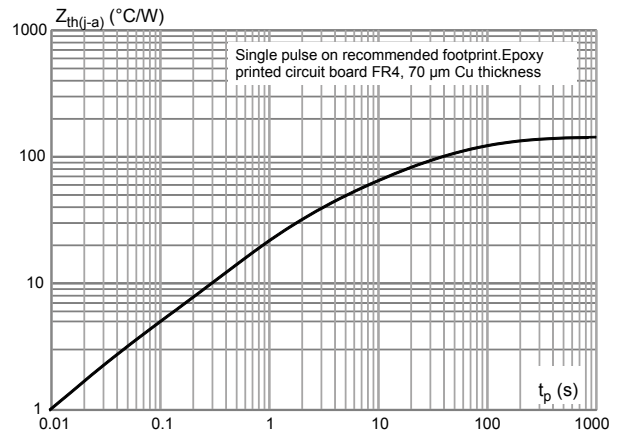
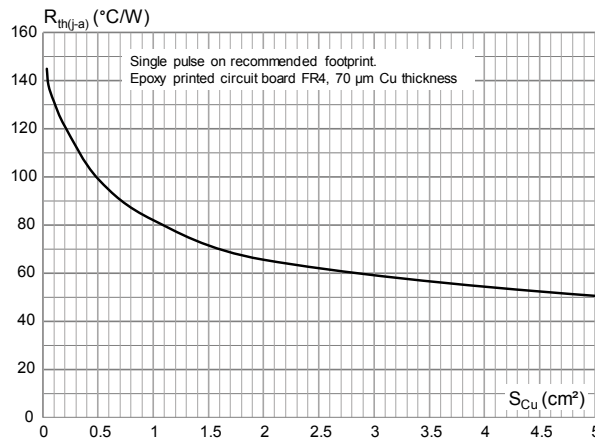


Figure 11. Thermal resistance junction to ambient versus copper area under each lead (SMB Flat)



## 2 Package information

In order to meet environmental requirements, ST offers these devices in different grades of **ECOPACK** packages, depending on their level of environmental compliance. ECOPACK specifications, grade definitions and product status are available at: [www.st.com](http://www.st.com). ECOPACK is an ST trademark.

### 2.1 SMB Flat package information

Figure 12. SMB Flat package outline

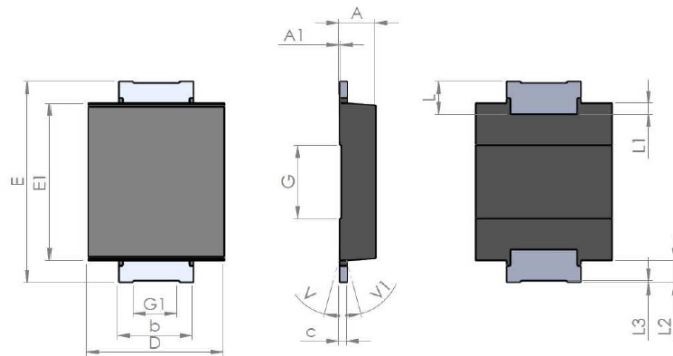
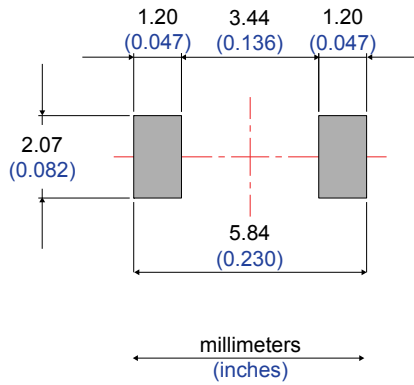


Table 3. SMB Flat mechanical data

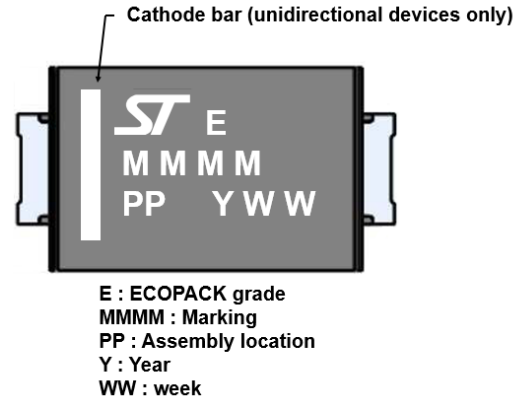
Ref.	Dimensions					
	Millimeters			Inches <sup>(1)</sup>		
	Min.	Typ.	Max.	Min.	Typ.	Max.
A	0.90		1.10	0.035		0.044
A1		0.05			0.002	
b	1.95		2.20	0.076		0.087
c	0.15		0.40	0.005		0.016
D	3.30		3.95	0.129		0.156
E	5.20		5.60	0.204		0.221
E1	4.05		4.60	0.159		0.182
G		2.00			0.079	
G1		1.20			0.047	
L	0.75		1.20	0.029		0.048
L1		0.30			0.012	
L2		0.60			0.024	
L3	0.02			0.000		
V			8°			8°
V1			8°			8°

1. Values in inches are converted from mm and rounded to 3 decimal digits.

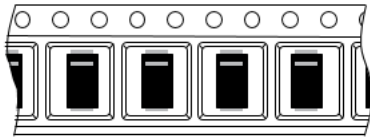
**Figure 13. Footprint recommendations, dimensions in mm (inches)**



**Figure 14. Marking layout (refer to ordering information table for marking)**

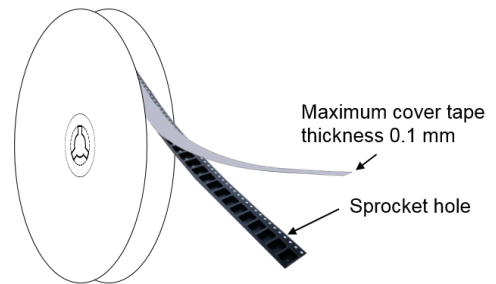


**Figure 15. Package orientation in reel**

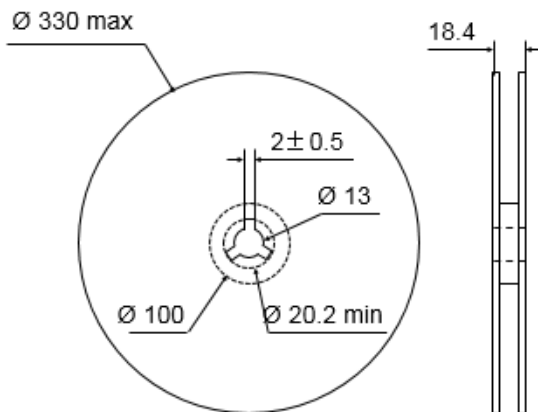


Taped according to EIA-481  
Note: Pocket dimensions are not on scale  
Pocket shape may vary depending on package  
On bidirectional devices, marking and logo may be not always in the same direction

**Figure 16. Tape and reel orientation**



**Figure 17. Reel dimensions (mm)**



**Figure 18. Inner box dimensions (mm)**

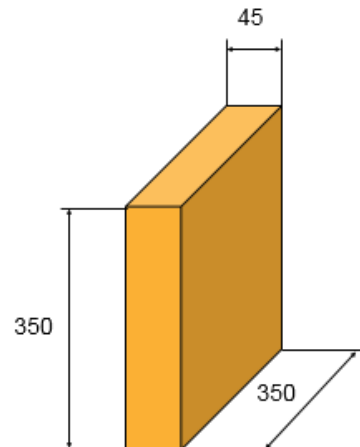
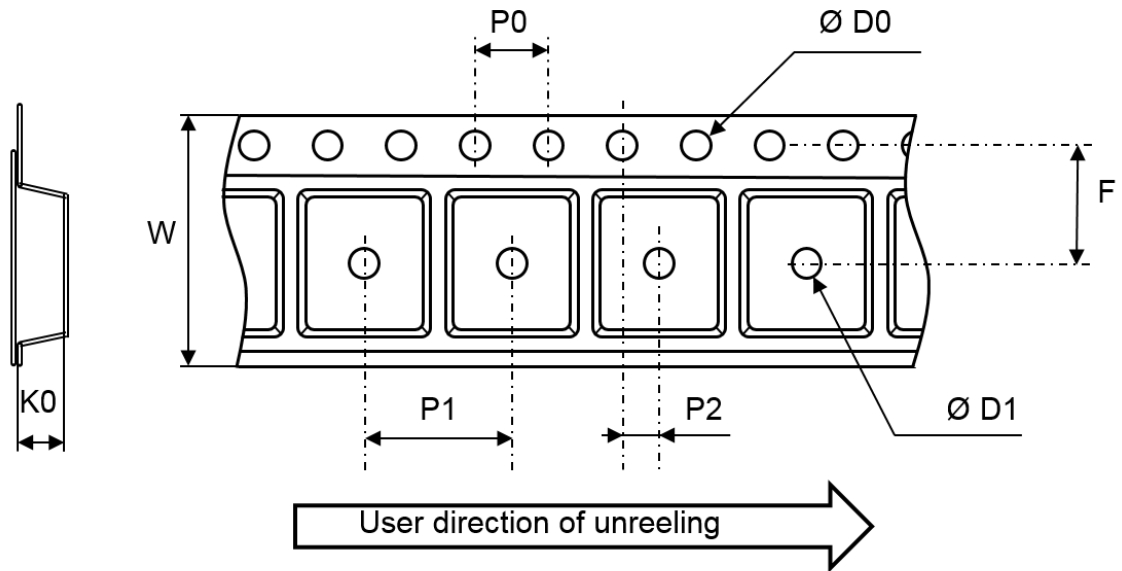


Figure 19. Tape and reel outline



Note: Pocket dimensions are not on scale  
Pocket shape may vary depending on package

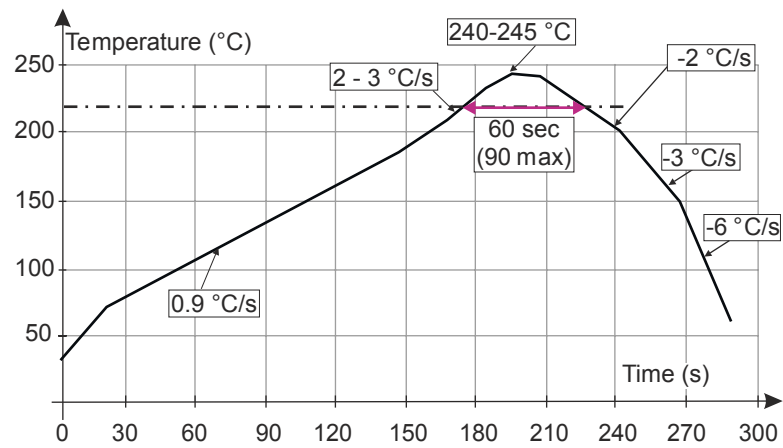
Table 4. Tape and reel mechanical data

Ref.	Dimensions		
	Millimeters		
	Min.	Typ.	Max.
ØD0	1.45	1.50	1.55
ØD1	1.5		
F	5.4	5.5	5.6
K0	1.2	1.3	1.4
P0	3.9	4.0	4.1
P1	7.9	8.0	8.1
P2	1.9	2.0	2.1
W	11.7	12.0	12.3



## 2.2 Reflow profile

Figure 20. ST ECOPACK recommended soldering reflow profile for PCB mounting



Note: Minimize air convection currents in the reflow oven to avoid component movement. Maximum soldering profile corresponds to the latest IPC/JEDEC J-STD-020.

### 3 Ordering information

Figure 21. Ordering information scheme

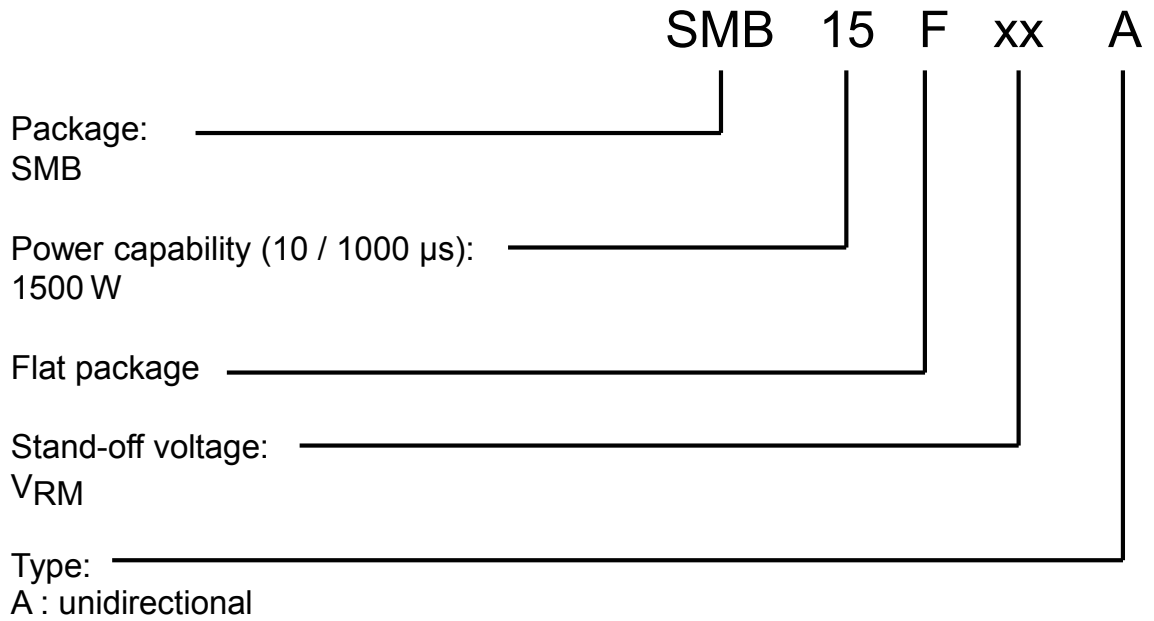


Table 5. Ordering information

Order code	Marking	Package	Weight	Base qty.	Delivery mode
SMB15FxxA	See Table 6. Marking.	SMB Flat	60 mg	5000	Tape and reel

**Table 6. Marking**

Order code	Marking
SMB15F5.0A	FAI
SMB15F6.0A	FAK
SMB15F6.5A	FAL
SMB15F8.5A	FAP
SMB15F10A	FAS
SMB15F11A	FAU
SMB15F12A	FAW
SMB15F13A	FAY
SMB15F14A	FBA
SMB15F15A	FBC
SMB15F16A	FBE
SMB15F18A	FBI
SMB15F20A	FBM
SMB15F22A	FBO
SMB15F23A	FBP
SMB15F24A	FBQ
SMB15F26A	FBS
SMB15F28A	FBU
SMB15F30A	FBW
SMB15F31A	FBX
SMB15F33A	FBZ
SMB15F36A	FCC
SMB15F40A	FCG
SMB15F48A	FCO
SMB15F58A	FCY
SMB15F64A	FDE

## Revision history

**Table 7. Document revision history**

Date	Revision	Changes
31-Aug-2020	1	Initial release.

**IMPORTANT NOTICE – PLEASE READ CAREFULLY**

STMicroelectronics NV and its subsidiaries (“ST”) reserve the right to make changes, corrections, enhancements, modifications, and improvements to ST products and/or to this document at any time without notice. Purchasers should obtain the latest relevant information on ST products before placing orders. ST products are sold pursuant to ST’s terms and conditions of sale in place at the time of order acknowledgement.

Purchasers are solely responsible for the choice, selection, and use of ST products and ST assumes no liability for application assistance or the design of Purchasers’ products.

No license, express or implied, to any intellectual property right is granted by ST herein.

Resale of ST products with provisions different from the information set forth herein shall void any warranty granted by ST for such product.

ST and the ST logo are trademarks of ST. For additional information about ST trademarks, please refer to [www.st.com/trademarks](http://www.st.com/trademarks). All other product or service names are the property of their respective owners.

Information in this document supersedes and replaces information previously supplied in any prior versions of this document.

© 2020 STMicroelectronics – All rights reserved

## X-ON Electronics

Largest Supplier of Electrical and Electronic Components

*Click to view similar products for [ESD Suppressors / TVS Diodes](#) category:*

*Click to view products by [STMicroelectronics](#) manufacturer:*

Other Similar products are found below :

[60KS200C](#) [D12V0H1U2WS-7](#) [D18V0L1B2LP-7B](#) [82356050220](#) [D5V0M5U6V-7](#) [NTE4902](#) [P4KE27CA](#) [P6KE11CA](#) [P6KE39CA-TP](#)  
[P6KE8.2A](#) [SA110CA](#) [SA60CA](#) [SA64CA](#) [SMBJ12CATR](#) [SMBJ8.0A](#) [SMLJ30CA-TP](#) [ESD101-B1-02ELS E6327](#) [ESD112-B1-02EL E6327](#)  
[ESD119B1W01005E6327XTSA1](#) [ESD5V0J4-TP](#) [ESD5V0L1B02VH6327XTSA1](#) [ESD7451N2T5G](#) [19180-510](#) [CPDT-5V0USP-HF](#)  
[3.0SMCJ33CA-F](#) [3.0SMCJ36A-F](#) [HSPC16701B02TP](#) [D3V3Q1B2DLP3-7](#) [D55V0M1B2WS-7](#) [DESD5V0U1BL-7B](#) [DRTR5V0U4SL-7](#)  
[SCM1293A-04SO](#) [ESD200-B1-CSP0201 E6327](#) [ESD203-B1-02EL E6327](#) [SM12-7](#) [SMF8.0A-TP](#) [SMLJ45CA-TP](#) [CEN955 W/DATA](#)  
[82350120560](#) [82356240030](#) [VESD12A1A-HD1-GS08](#) [CPDUR5V0R-HF](#) [CPDUR24V-HF](#) [CPDQC5V0U-HF](#) [CPDQC5V0USP-HF](#)  
[CPDQC5V0-HF](#) [D1213A-01LP4-7B](#) [D1213A-02WL-7](#) [ESDLIN1524BJ-HQ](#) [5KP100A](#)