

**Trisil™ for telecommunication equipment protection**

Datasheet – production data

**Features**

- Bidirectional crowbar protection
- Repetitive peak pulse current ( $T_{amb}$  -40 °C to +85 °C)
  - $I_{PP} = 100$  A (10/1000  $\mu$ s)
  - $I_{PP} = 200$  A (5/310  $\mu$ s)
  - $I_{PP} = 500$  A (2/10  $\mu$ s)
- Breakdown voltage: from 72 V to 310 V
- Operating  $T_j$  max: 150 °C
- Micro capacitance technology
- JEDEC registered package outline

**Complies with the following standards**

- Telcordia GR-1089
- ITU-T K20/21/45 enhanced level
- TIA-968
- YD/T 950 / 993 / 1082
- IEC 61000-4-5
- IEC 61000-4-2 level 4
  - $\pm 15$  kV (air discharge)
  - $\pm 8$  kV (contact discharge)
- MIL STD 883H - Method 3015-8 Class 3B
- Resin meets UL 94, V0
- MIL-STD-750, method 2026 solderability
- EIA STD RS-481 and IEC 60286-3 packing
- IPC 7531 footprint
- UL497B recognized, UL file E136224

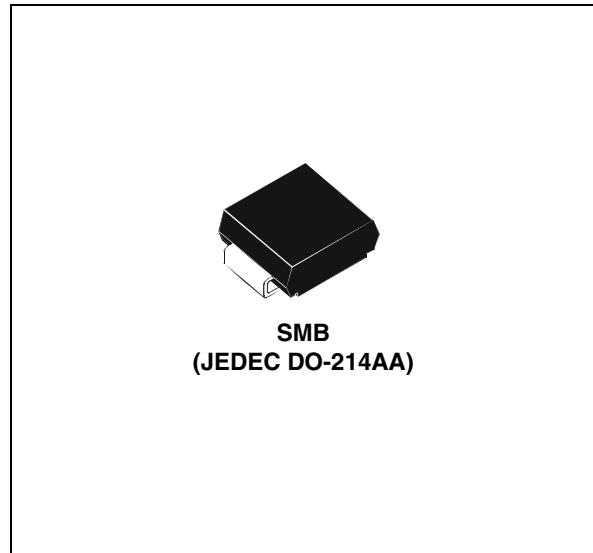
**Description**

The devices in the SMP-0SCMC series are micro capacitance Trisils designed to protect broadband telecommunication equipment such as DSL modems, subscriber gateways and DSLAMs from lightning surges and power faults.

Trisils are not subject to aging and provide a failsafe mode in short circuit for a better protection. They are used to help equipment to meet main standards such as UL60950, IEC950 / CSA C22.2 and UL1459.

The SMP-0SCMC series is packaged in SMB.

TM: Trisil is a trademark of STMicroelectronics

# 1 Characteristics

**Table 1. Absolute ratings ( $-40\text{ °C} < T_{\text{amb}} < 85\text{ °C}$ ) for repetitive peak pulse current  $I_{\text{PP}}$**

<b>Voltage pulse</b>	0.5/700	2/10	1.2/50	10/160	10/560	9/720	10/360	10/1000	10/700	$\mu\text{s}$
<b>Current pulse</b>	0.2/310	2/10	8/20	10/160	10/560	5/320	10/360	10/1000	5/310	$\mu\text{s}$
<b><math>I_{\text{PP}}</math></b>	100	500	400	200	150	200	175	100	200	A

**Table 2. Absolute ratings ( $T_{\text{amb}} = 25\text{ °C}$ ) for other parameters**

Symbol	Parameter	Value	Unit	
$I_{\text{TSM}}$	Non repetitive surge peak on-state current (sinusoidal) <sup>(1)</sup>	$t = 10\text{ ms}$	61	A
		$t = 0.2\text{ s}$	18	
		$t = 1\text{ s}$	9	
		$t = 2\text{ s}$	7	
		$t = 15\text{ mn}$	4	
$T_{\text{stg}}$	Storage temperature range	-55 to 150	$^{\circ}\text{C}$	
$T_{\text{j}}$	Operating junction temperature range	-40 to 150	$^{\circ}\text{C}$	
$T_{\text{L}}$	Maximum lead temperature for soldering during 10 s.	260	$^{\circ}\text{C}$	

1. In fail safe mode, the device acts as a short circuit.

**Figure 1. Electrical characteristics - definitions ( $T_{\text{amb}} = 25\text{ °C}$ )**

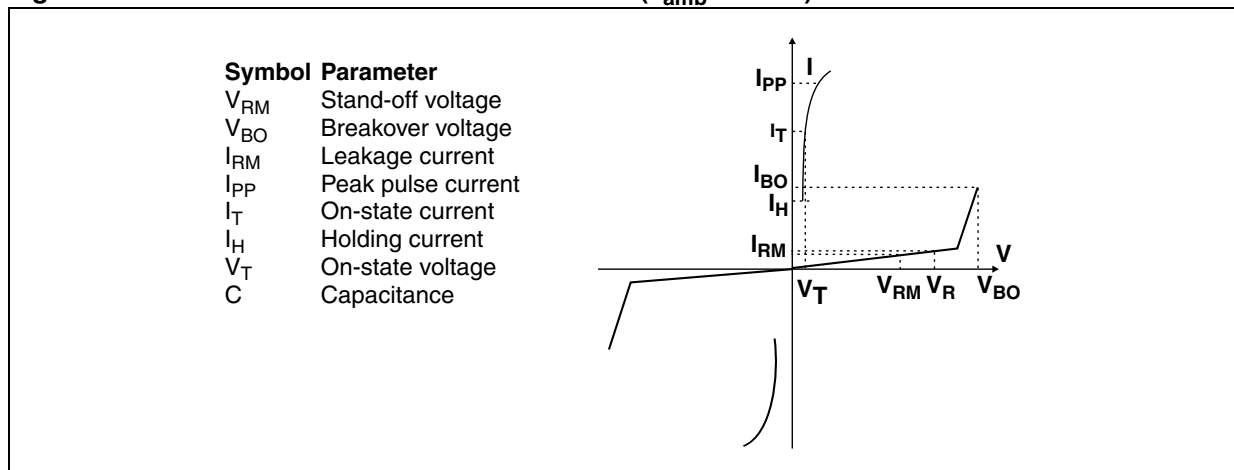
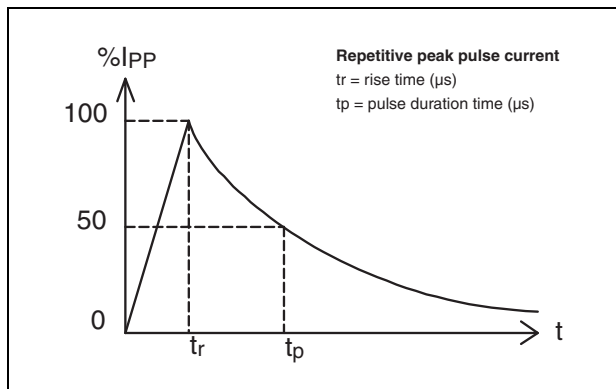

**Table 3. Electrical characteristics - values ( $T_{amb} = 25\text{ }^{\circ}\text{C}$ )**

Order code	$I_{RM} \text{ max @ } V_{RM}$		$V_{BR}$	$V_{BO}$	$I_H$	$V_T @ 2.2 \text{ A}$	$C @ 2 \text{ V}$	$C @ 50 \text{ V}$	$\alpha T^{(1)}$
	Max.		Typ.	Max.	Min.	Max.	Max.	Max.	
	$\mu\text{A}$	V	V	V	mA	V	pF	pF	$10^{-4}/^{\circ}\text{C}$
SMP0720SCMC	5	65	72	88	150	3	80	45	9
SMP0900SCMC	5	75	90	98	150	3	80	45	9.1
SMP1100SCMC	5	90	110	130	150	3	75	40	9.3
SMP1300SCMC	5	120	130	160	150	3	75	40	9.5
SMP1500SCMC	5	140	150	180	150	3	75	40	9.7
SMP1800SCMC	5	170	180	220	150	3	70	35	9.9
SMP2100SCMC	5	180	210	240	150	3	45	25	10.2
SMP2300SCMC	5	190	230	260	150	3	45	25	10.3
SMP2600SCMC	5	220	260	300	150	3	40	20	10.6
SMP3100SCMC	5	275	310	350	150	3	40	20	11

1. For  $V_{BR}$  versus junction temperature, use the following formula:  $V_{BR} @ T_J = V_{BR} @ 25\text{ }^{\circ}\text{C} \times (1 + \alpha T \times (T_J - 25))$

**Figure 2. Pulse waveform**



**Figure 3. Non repetitive surge peak on-state current versus overload duration**

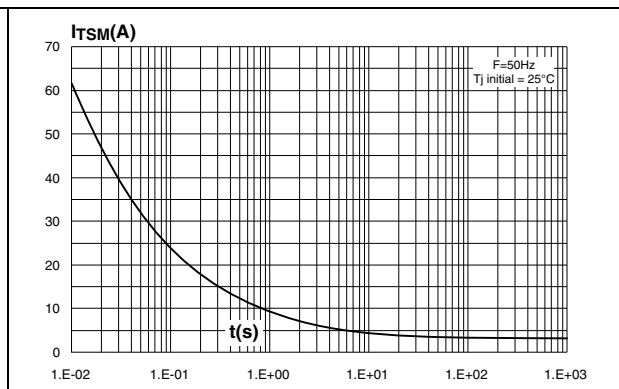

Figure 4. Relative variation of holding current versus junction temperature

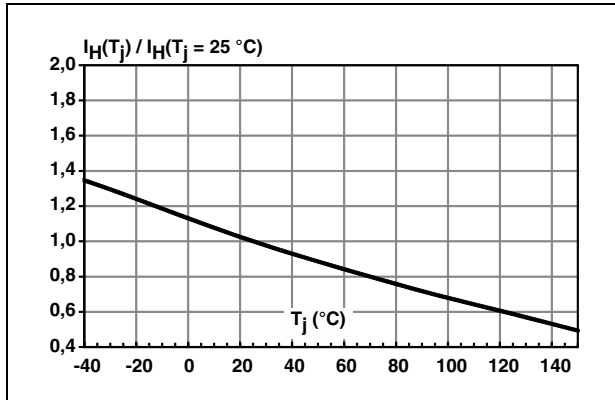

Figure 5. Percentage of change of break over voltage versus junction temperature

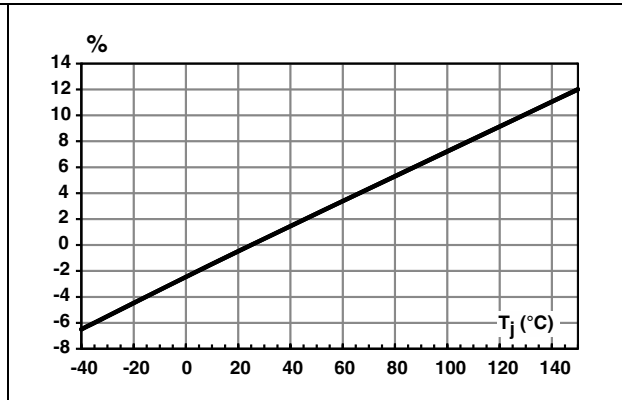
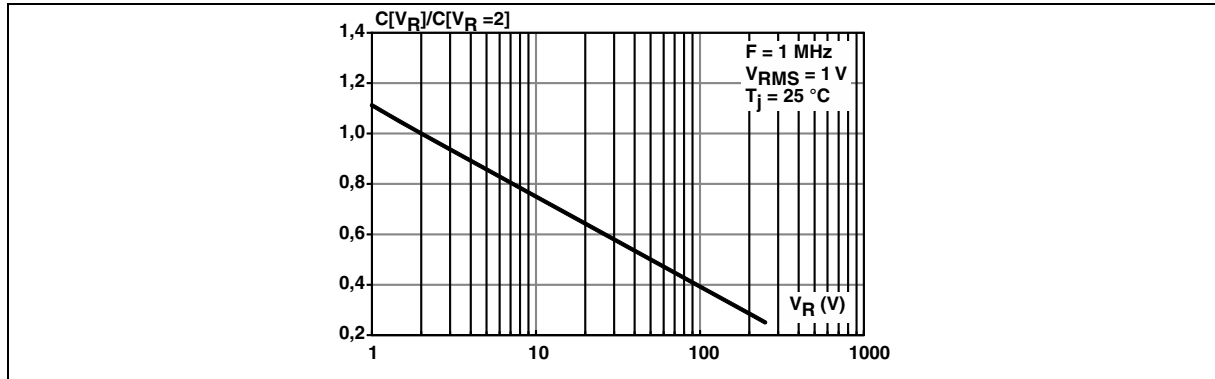

Figure 6. Relative variation of junction capacitance versus reverse applied voltage (typical values)



## 2 Package information

- Epoxy meets UL94, V0
- Lead-free package

In order to meet environmental requirements, ST offers these devices in different grades of ECOPACK® packages, depending on their level of environmental compliance. ECOPACK® specifications, grade definitions and product status are available at: [www.st.com](http://www.st.com). ECOPACK® is an ST trademark.

**Table 4. SMB dimensions**

Ref.	Dimensions			
	Millimeters		Inches	
	Min.	Max.	Min.	Max.
A1	1.90	2.45	0.075	0.096
A2	0.05	0.20	0.002	0.008
b	1.95	2.20	0.077	0.087
c	0.15	0.40	0.006	0.016
E	5.10	5.60	0.201	0.220
E1	4.05	4.60	0.159	0.181
D	3.30	3.95	0.130	0.156
L	0.75	1.50	0.030	0.059

**Figure 7. Footprint dimensions in mm (inches)**

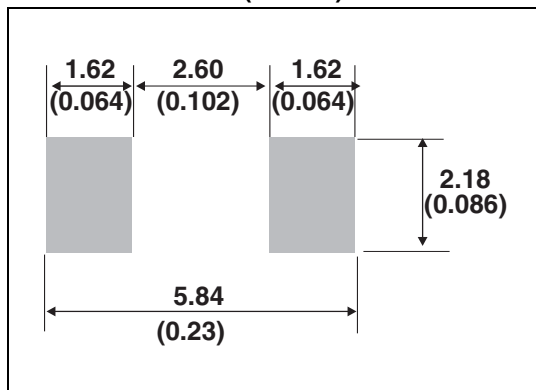

**Figure 8. Marking layout**

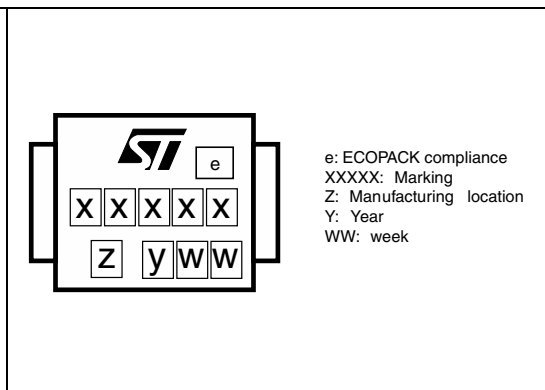

### 3 Ordering information

**Table 5. Ordering information**

Order code	Marking	Package	Weight	Base qty	Delivery mode
SMP0720SCMC	P07CM	SMB	98 mg	2500	Tape and reel
SMP0900SCMC	P09CM				
SMP1100SCMC	P11CM				
SMP1300SCMC	P13CM				
SMP1500SCMC	P15CM				
SMP1800SCMC	P18CM				
SMP2100SCMC	P21CM				
SMP2300SCMC	P23CM				
SMP2600SCMC	P26CM				
SMP3100SCMC	P31CM				

### 4 Revision history

**Table 6. Document revision history**

Date	Revision	Changes
17-Jan-2013	1	Initial version.

**Please Read Carefully:**

Information in this document is provided solely in connection with ST products. STMicroelectronics NV and its subsidiaries ("ST") reserve the right to make changes, corrections, modifications or improvements, to this document, and the products and services described herein at any time, without notice.

All ST products are sold pursuant to ST's terms and conditions of sale.

Purchasers are solely responsible for the choice, selection and use of the ST products and services described herein, and ST assumes no liability whatsoever relating to the choice, selection or use of the ST products and services described herein.

No license, express or implied, by estoppel or otherwise, to any intellectual property rights is granted under this document. If any part of this document refers to any third party products or services it shall not be deemed a license grant by ST for the use of such third party products or services, or any intellectual property contained therein or considered as a warranty covering the use in any manner whatsoever of such third party products or services or any intellectual property contained therein.

**UNLESS OTHERWISE SET FORTH IN ST'S TERMS AND CONDITIONS OF SALE ST DISCLAIMS ANY EXPRESS OR IMPLIED WARRANTY WITH RESPECT TO THE USE AND/OR SALE OF ST PRODUCTS INCLUDING WITHOUT LIMITATION IMPLIED WARRANTIES OF MERCHANTABILITY, FITNESS FOR A PARTICULAR PURPOSE (AND THEIR EQUIVALENTS UNDER THE LAWS OF ANY JURISDICTION), OR INFRINGEMENT OF ANY PATENT, COPYRIGHT OR OTHER INTELLECTUAL PROPERTY RIGHT.**

**UNLESS EXPRESSLY APPROVED IN WRITING BY TWO AUTHORIZED ST REPRESENTATIVES, ST PRODUCTS ARE NOT RECOMMENDED, AUTHORIZED OR WARRANTED FOR USE IN MILITARY, AIR CRAFT, SPACE, LIFE SAVING, OR LIFE SUSTAINING APPLICATIONS, NOR IN PRODUCTS OR SYSTEMS WHERE FAILURE OR MALFUNCTION MAY RESULT IN PERSONAL INJURY, DEATH, OR SEVERE PROPERTY OR ENVIRONMENTAL DAMAGE. ST PRODUCTS WHICH ARE NOT SPECIFIED AS "AUTOMOTIVE GRADE" MAY ONLY BE USED IN AUTOMOTIVE APPLICATIONS AT USER'S OWN RISK.**

Resale of ST products with provisions different from the statements and/or technical features set forth in this document shall immediately void any warranty granted by ST for the ST product or service described herein and shall not create or extend in any manner whatsoever, any liability of ST.

ST and the ST logo are trademarks or registered trademarks of ST in various countries.

Information in this document supersedes and replaces all information previously supplied.

The ST logo is a registered trademark of STMicroelectronics. All other names are the property of their respective owners.

© 2013 STMicroelectronics - All rights reserved

STMicroelectronics group of companies

Australia - Belgium - Brazil - Canada - China - Czech Republic - Finland - France - Germany - Hong Kong - India - Israel - Italy - Japan - Malaysia - Malta - Morocco - Philippines - Singapore - Spain - Sweden - Switzerland - United Kingdom - United States of America

[www.st.com](http://www.st.com)

## X-ON Electronics

Largest Supplier of Electrical and Electronic Components

*Click to view similar products for [Triacs](#) category:*

*Click to view products by [STMicroelectronics](#) manufacturer:*

Other Similar products are found below :

[CTA08-1000CW](#) [CTB24-800BW](#) [CTA08-1000C](#) [CTA12-800BWPT](#) [CTA16-1000B](#) [CTB24-800B](#) [BT137-600-0Q](#) [5615](#) [OT415Q](#) [2N6075A](#)  
[NTE5629](#) [NTE5688](#) [CTB08-400CW](#) [D31410](#) [T2535T-8I](#) [BTA425Z-800BTQ](#) [KS100N12](#) [TOPT16-800C0,127](#) [OT408,135](#) [BT134-800E](#)  
[BT136D](#) [BTB16Q-600BW](#) [Z0409MF](#) [BTA04-600B](#) [BTA06-600BRG](#) [BTA06-800BWRG](#) [BTA08-600BRG](#) [BTA08-800B](#) [BT136-600,127](#)  
[MAC97A6,116](#) [BT137-600E,127](#) [BTB16-600CW3G](#) [BTB16-600CW3G](#) [Z0109MN,135](#) [T825T-6I](#) [T1220T-6I](#) [NTE5638](#) [ACST1235-8FP](#)  
[BT136X-600E,127](#) [MAC4DLM-1G](#) [BT134-600D,127](#) [BTA08-600BW3G](#) [NTE56008](#) [NTE56017](#) [NTE56018](#) [NTE56059](#) [NTE5608](#)  
[NTE5609](#) [NTE5656](#) [NTE56020](#)