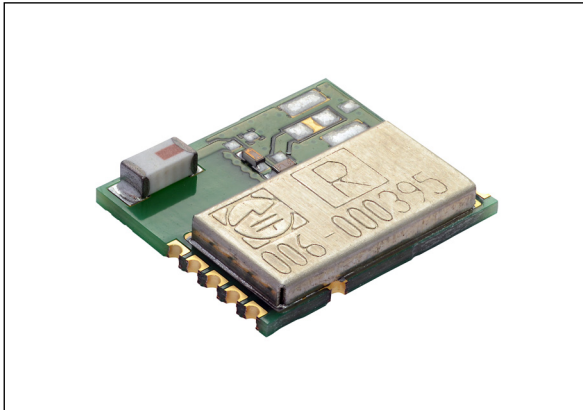

---

**Very low power network processor module for Bluetooth® low energy v4.1**

---

**Datasheet - production data****Features**

- Bluetooth v4.1 compliant
  - Supports master and slave modes
  - Multiple roles supported simultaneously
- Embedded Bluetooth low energy protocol stack
  - GAP, GATT, SM, L2CAP, LL, RFPHY
- Bluetooth low energy profiles provided separately
- Bluetooth radio performance:
  - Embedded ST BlueNRG-MS
  - Tx power: + 4 dBm
  - Rx sensitivity: - 88 dBm
  - Provides up to 92 dB link budget with excellent link reliability
- Host interface
  - SPI, IRQ, and RESET
  - On-field stack upgrading available via SPI
- AES security co-processor
- Certification
  - CE qualified
  - FCC, IC modular approval certified
  - TELEC
  - BQE qualified

- On-board chip antenna
- Operating supply voltage: from 1.7 to 3.6 V
- Operating temperature range: -40 °C to 85 °C

**Applications**

- Watches
- Fitness, wellness and sports
- Consumer medical
- Security/proximity
- Remote control
- Home and industrial automation
- Assisted living
- Mobile phone peripherals
- PC peripherals

**Description**

The SPBTLE-RF is an easy to use Bluetooth® low energy master/slave network processor module, compliant with Bluetooth v4.1. The SPBTLE-RF module supports multiple roles simultaneously, and can act at the same time as Bluetooth low energy sensor and hub device.

The entire Bluetooth low energy stack and protocols are embedded into SPBTLE-RF module. The external host application processor, where the application resides, is connected to the SPBTLE-RF module through a standard SPI interface.

The SPBTLE-RF module provides a complete RF platform in a tiny form factor. Radio, antenna, high frequency and LPO oscillators are integrated to offer a certified solution to optimize the time to market of the final applications.

The SPBTLE-RF can be powered directly with a standard 3 V coin cell battery, a pair of AAA batteries or any power source from 1.7 to 3.6 V.

# Contents

- 1      General description ..... 3**
- 2      Block diagram ..... 4**
- 3      Software architecture ..... 5**
  - 3.1    Bluetooth firmware implementation ..... 5
- 4      Hardware specifications ..... 6**
  - 4.1    Absolute maximum ratings ..... 6
  - 4.2    Recommended operating conditions ..... 6
  - 4.3    Current consumption ..... 6
  - 4.4    Current consumption comparison ..... 7
  - 4.5    Pin assignment ..... 10
  - 4.6    Mechanical dimensions ..... 11
- 5      Hardware design ..... 13**
  - 5.1    Reflow soldering ..... 13
- 6      Regulatory compliance ..... 15**
  - 6.1    FCC certification ..... 15
    - 6.1.1    Labeling instructions ..... 15
    - 6.1.2    Product manual instructions ..... 16
  - 6.2    IC certification ..... 16
    - 6.2.1    Labeling instructions ..... 17
    - 6.2.2    Product manual instructions ..... 18
  - 6.3    CE certification ..... 18
  - 6.4    Bluetooth certification ..... 19
  - 6.5    TELEC certification ..... 19
- 7      Ordering information ..... 20**
- 8      ECOPACK® ..... 21**
- 9      Traceability ..... 21**
- 10     Revision history ..... 22**

# 1 General description

The SPBTLE-RF is a single-mode Bluetooth low energy master/slave network processor module compliant with Bluetooth® v4.1.

The SPBTLE-RF module integrates a 2.4 GHz RF radio the ST BlueNRG-MS on which a complete power-optimized stack for Bluetooth single mode protocol runs, providing

- Master, slave role support
- GAP: central, peripheral, observer or broadcaster roles
- ATT/GATT: client and server
- SM: privacy, authentication and authorization
- L2CAP
- Link Layer: AES-128 encryption and decryption

The BlueNRG-MS radio embeds nonvolatile Flash memory allows on-field stack upgrading.

In addition, according the Bluetooth specification v4.1 the SPBTLE-RF module provides:

- Multiple roles simultaneously support
- Support simultaneous advertising and scanning
- Support being slave of up to two masters simultaneously
- Privacy V1.1
- Low duty cycle directed advertising
- Connection parameters request procedure
- LE Ping
- 32 bits UUIDs
- L2CAP connection oriented channels

The SPBTLE-RF module is equipped with Bluetooth low energy profiles in C source code, available for the ST radio BlueNRG-MS.

The external host application processor, where the application resides, is interfaced with the SPBTLE-RF module through an application controller interface protocol, which is based on a standard SPI interface.

The SPBTLE-RF module enables wireless connectivity into electronic devices, not requiring any RF experience or expertise for integration into the final product. The SPBTLE-RF module provides a complete RF platform in a tiny form factor and being a certified solution optimizes the time to market of the final applications.

The SPBTLE-RF module allows applications to meet of the tight advisable peak current requirements imposed with the use of standard coin cell batteries. Optimized results are obtained when the embedded high-efficiency DC-DC step-down converter is used. SPBTLE-RF can be powered directly with a standard 3 V coin cell battery, a pair of AAA batteries or any power source from 1.7 to 3.6 V.

ST may update the FW provided with the modules at any time. ST recommends that users regularly check for documentation and the current FW version available at [www.st.com/bluemodules](http://www.st.com/bluemodules).

## 2 Block diagram

Figure 1. HW block diagram

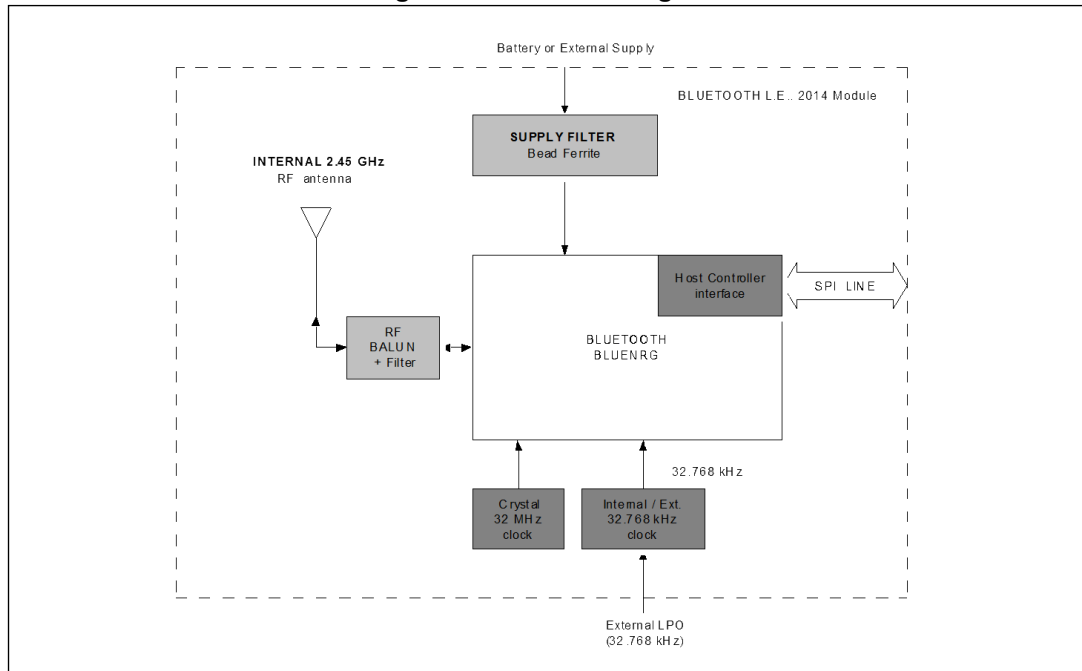

### 3 Software architecture

#### 3.1 Bluetooth firmware implementation

Figure 2. SPBTLE-RF application block diagram

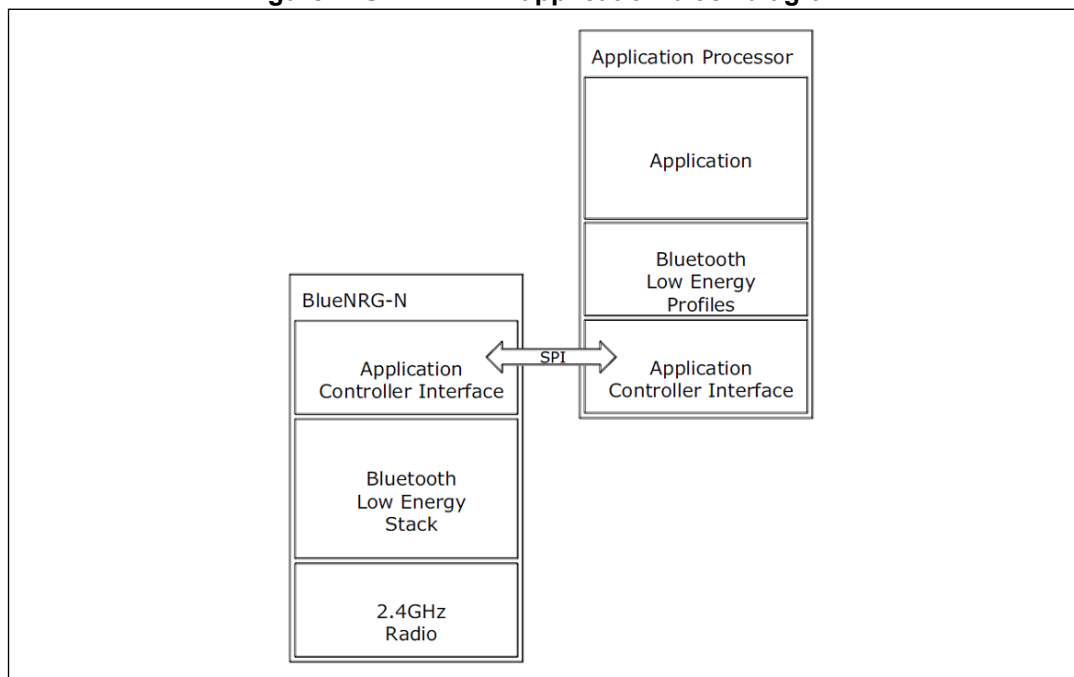

## 4 Hardware specifications

General conditions ( $V_{IN}$ = 3.3 V and 25 °C)

### 4.1 Absolute maximum ratings

Table 1. Absolute maximum ratings

| Rating   | Min  | Typ. | Max | Unit |
|--|------|------|-----|------|
| Storage temperature range                          | -40  | -    | +85 | °C   |
| Supply voltage, $V_{IN}$                           | -0.3 | -    | 3.9 | V    |
| I/O pin Voltage ( $V_{IO}$ five-volt tolerant pin) | -0.3 | -    | 3.9 | V    |
| RF saturation input power                          | -    | 8    | -   | dBm  |

### 4.2 Recommended operating conditions

Table 2. Recommended operating conditions

| Rating   | Min  | Typ. | Max  | Unit |
|--|------|------|------|------|
| Storage temperature range                            | -40  | -    | +85  | °C   |
| Supply voltage, $V_{IN}$                             | 1.7  | 3.3  | 3.6  | V    |
| Signals & I/O pin voltage (according supply voltage) | 1.7  | -    | 3.6  | V    |
| RF Frequency   | 2402 | -    | 2480 | MHz  |

### 4.3 Current consumption

Table 3. Current consumption summary

| Symbol   | Parameter      | Test conditions                   | Typ.  | Unit    |
|----------|----------------|-----------------------------------|-------|---------|
| $I_{DD}$ | Supply current | Shutdown / STANDBY                | 1.98  | $\mu$ A |
|          |                | Peripheral in advertising (20 ms) | 0.850 | mA      |
|          |                | Peripheral in advertising (80 ms) | 0.250 | mA      |
|          |                | Peripheral in connection          | 0.103 | mA      |
|          |                | Central in scan mode              | 7.72  | mA      |
|          |                | Central in connection             | 0.105 | mA      |

### 4.4 Current consumption comparison

The measured values reported in table 3 have been compared with the value calculated with the “BlueNRG current consumption estimation tool”, available on ST.com at:

<http://www.st.com/web/en/catalog/tools/PF260405>

The comparison between measured and calculated values is reported in following *Table 4*.

**Table 4. Current consumption comparison summary**

| Symbol          | Parameter      | Test conditions                   | Typ.  | Peak  | Calculated | Unit | Calculated value reference   |
|-----------------|----------------|-----------------------------------|-------|-------|------------|------|------------------------------|
| I <sub>DD</sub> | Supply current | Shutdown / STANDBY                | 1.98  |       | 2          | µA   | BlueNRG-MS Datasheet Table 7 |
|                 |                | Peripheral in advertising (20 ms) | 0.850 | 11.5  | 0.985      | mA   | Screenshot Figure 3          |
|                 |                | Peripheral in advertising (80 ms) | 0.250 | 15.7  | 0.247      | mA   | Screenshot Figure 4          |
|                 |                | Peripheral in connection          | 0.103 | 15    | 0.119      | mA   | Screenshot Figure 5          |
|                 |                | Central in scan mode              | 7.72  | 8.5   | 7.1 - 7.4  | mA   | Screenshot Figure 6          |
|                 |                | Central in connection             | 0.105 | 12.85 | 0.106      | mA   | Screenshot Figure 7          |

For each calculated value refer to the following screenshot

**Figure 3. Peripheral in advertising (20 ms)**

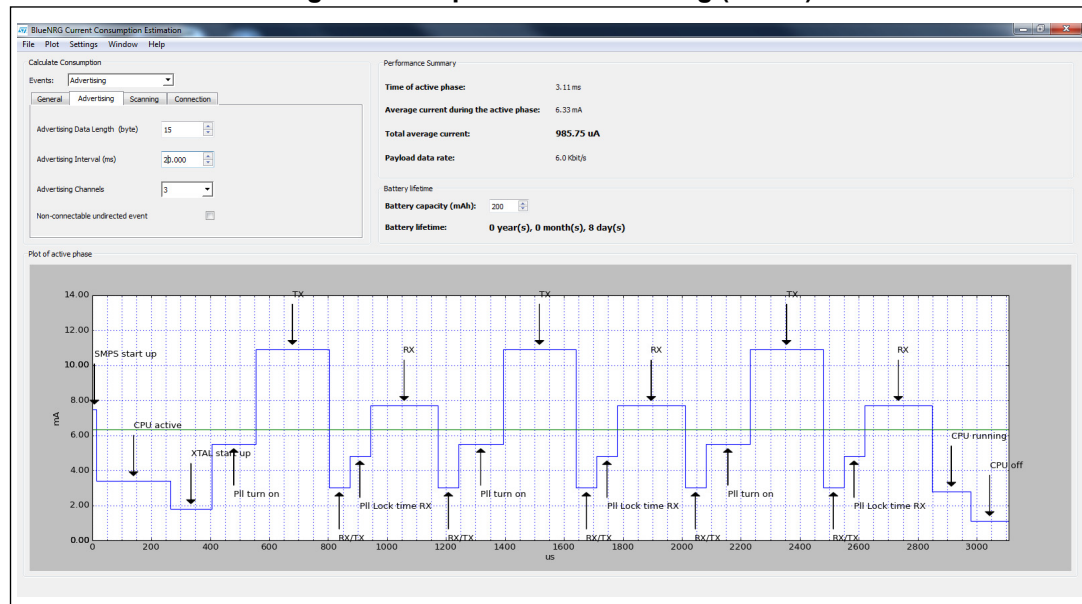

Figure 4. Peripheral in advertising (80 ms)

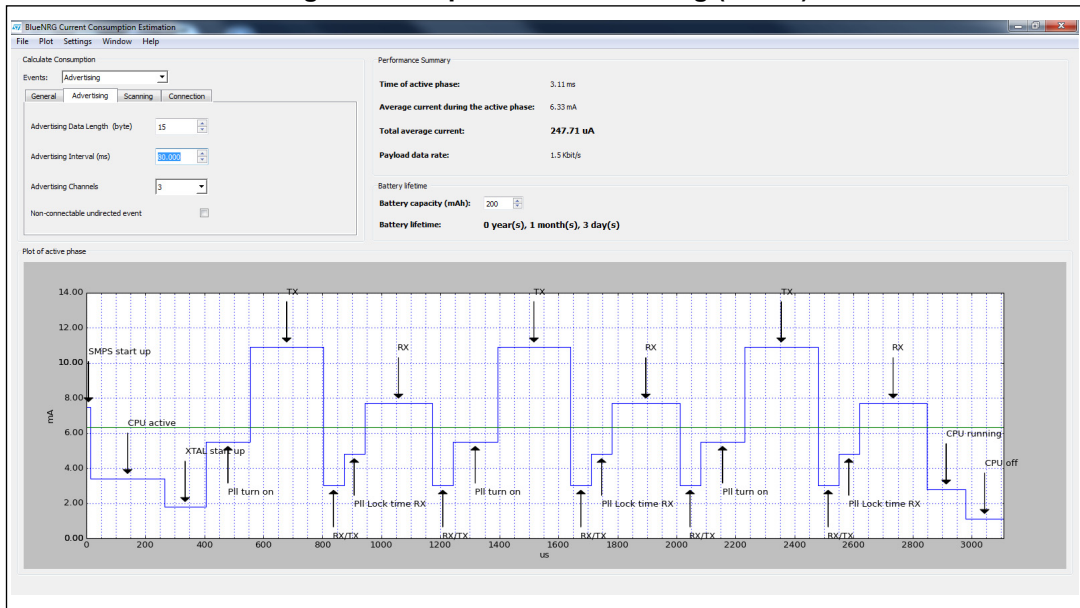

Figure 5. Peripheral in connection

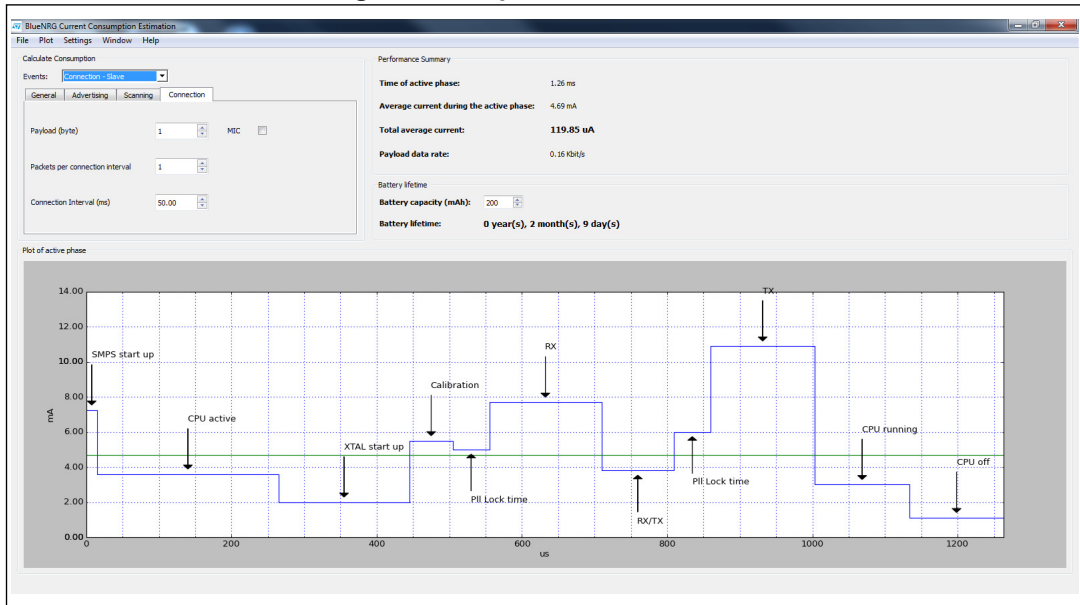



Figure 6. Central in scan mode

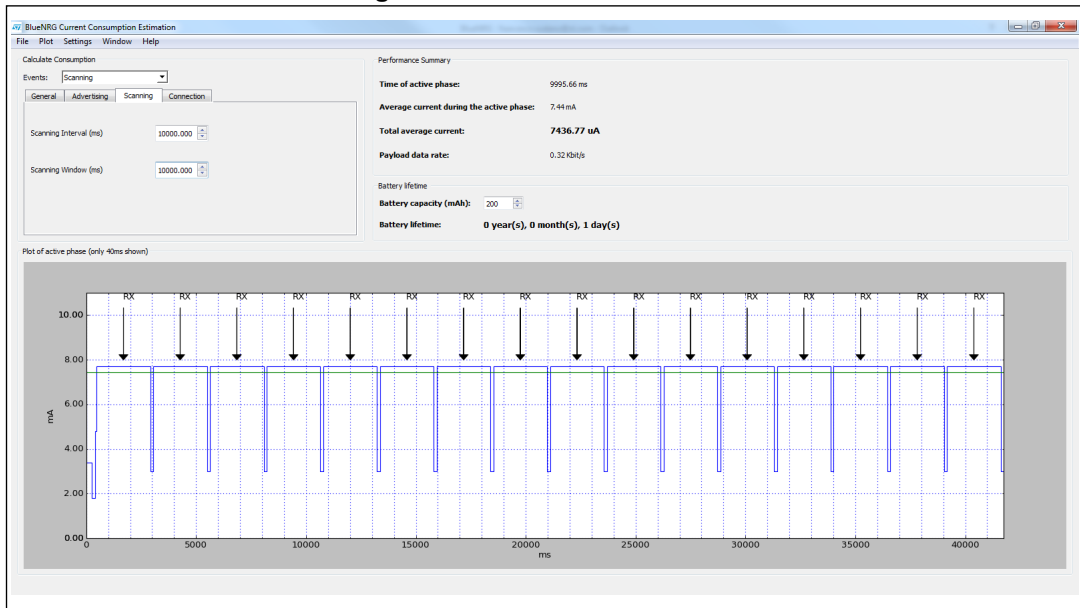
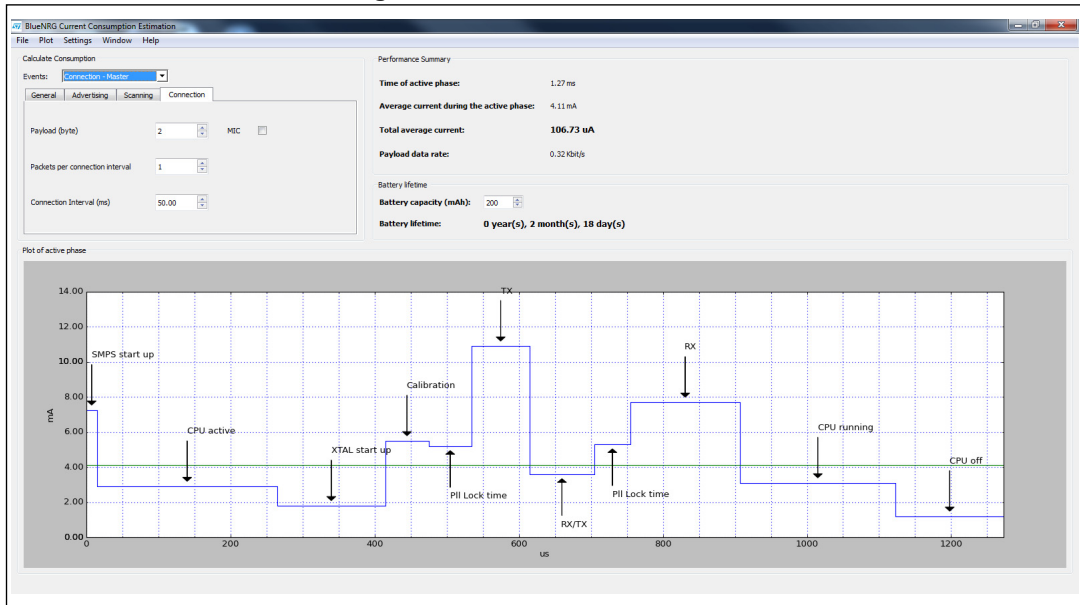

Figure 7. Central in connection



### 4.5 Pin assignment

Figure 8. Pin connection

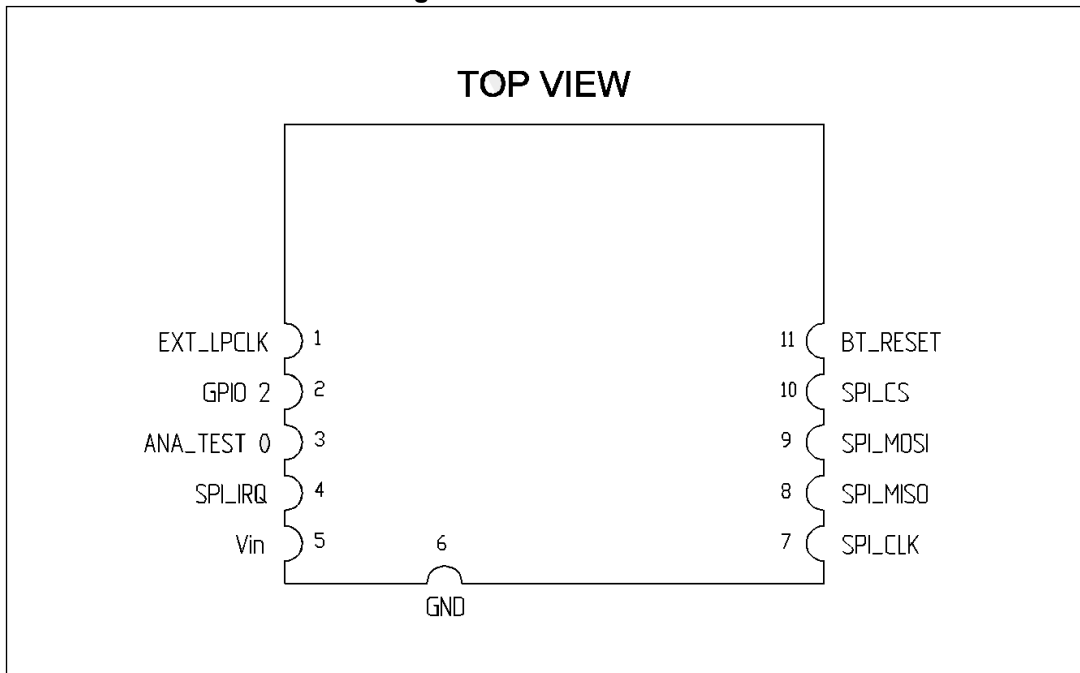

Table 5. Pin assignment

| Name             | Type | Pin # | Description                                      | V max. Tolerant    |
|------------------|------|-------|--|--------------------|
| SPI Interface    |      |       |  |                    |
| SPI_IRQ          | O    | 4     | SPI IRQ (SLAVE has data for MASTER)              | V <sub>in</sub>    |
| SPI_CLK          | I    | 7     | SPI CLOCK (Max. 8 MHz)                           | V <sub>in</sub>    |
| SPI_MISO         | O    | 8     | SPI MISO (MASTER in / SLAVE out)                 | V <sub>in</sub>    |
| SPI_MOSI         | I    | 9     | SPI MOSI (MASTER out SLAVE in)                   | V <sub>in</sub>    |
| SPI_CS           | I    | 10    | SPI "Chip select" (SPI slave select)             | V <sub>in</sub>    |
| Power and ground |      |       |  |                    |
| V <sub>in</sub>  |      | 5     | V <sub>in</sub>                                  | (1.7V - 3.6V max.) |
| GND              |      | 6     | GND  |                    |
| Reset            |      |       |  |                    |
| BT_RESET         | I    | 11    | Reset input (active low < 0.35 V <sub>in</sub> ) | (1.7V - 3.6V max.) |
| LPO              |      |       |  |                    |
| EXT_LPCLK        | I    | 1     | Not connected                                    |                    |
| GPIO2            | I/O  | 2     | Not connected                                    |                    |
| ANA TEST 0       | I    | 3     | Not connected                                    |                    |

### 4.6 Mechanical dimensions

Figure 9. Mechanical dimensions

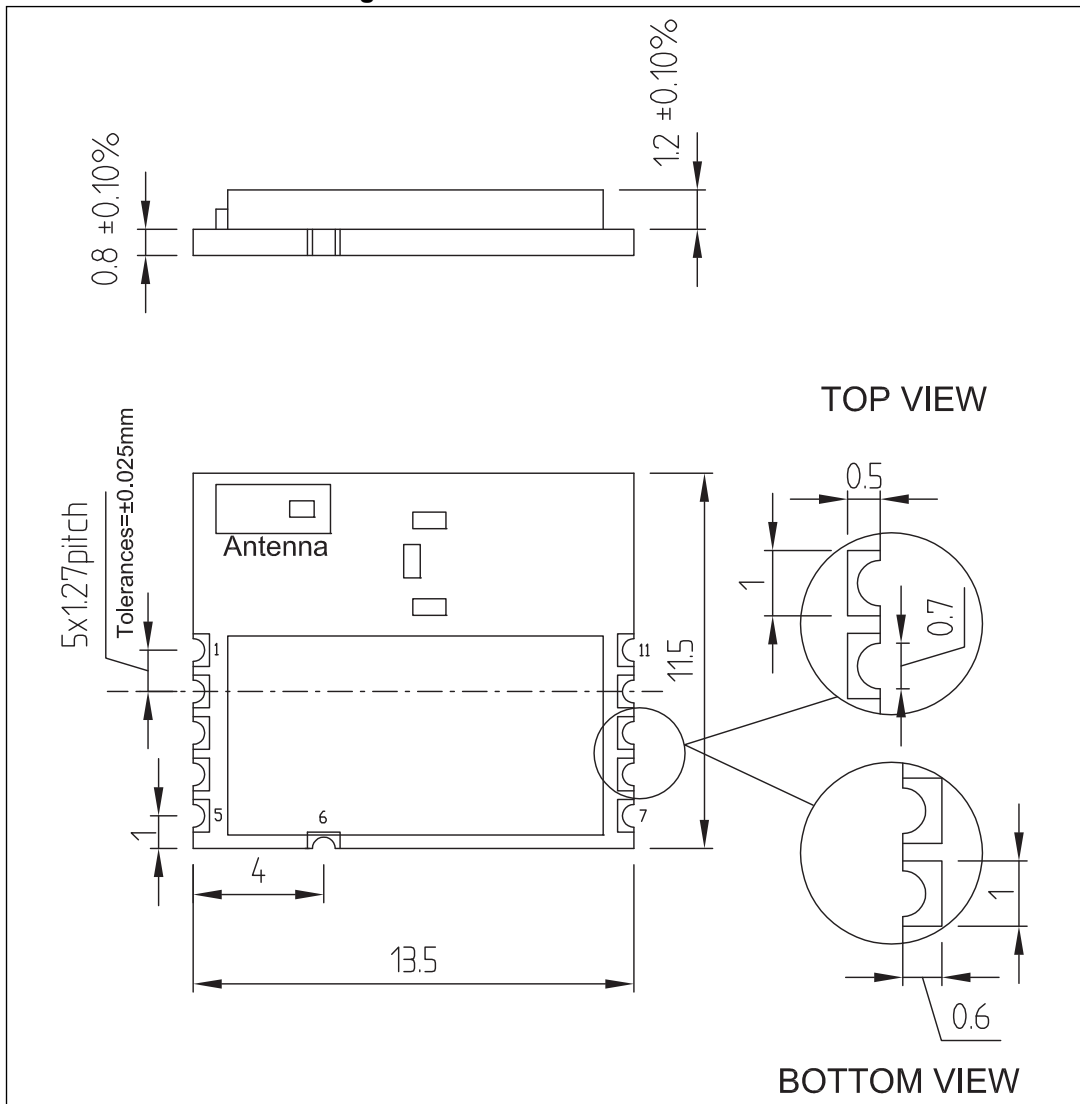
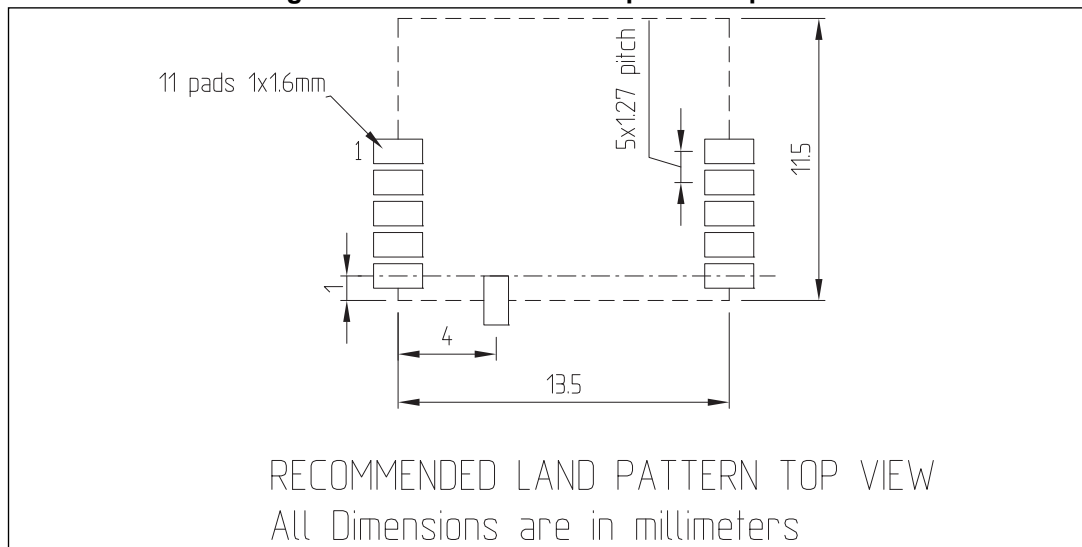

Figure 10. Recommend land pattern top view



## 5 Hardware design

SPBTLE-RF module supports SPI hardware interfaces.

Note:

- All unused pins should be left floating; do not ground.
- All GND pins must be well grounded.
- The area around the module should be free of any ground planes, power planes, trace routings, or metal for 6 mm from the module antenna position, in all directions.
- Traces should not be routed underneath the module.

### 5.1 Reflow soldering

The SPBTLE-RF is a high temperature strength surface mount Bluetooth® module supplied on a 11 pin, 4-layer PCB. The final assembly recommended reflow profiles are indicated here below.

Soldering phase has to be executed with care: in order to avoid undesired melting phenomenon, particular attention has to be taken on the set up of the peak temperature.

Here following some suggestions for the temperature profile based on following recommendations.

**Table 6. Soldering**

| Profile feature                                       | PB-free assembly |
|---|------------------|
| Average ramp up rate ( $T_{S\text{MAX}}$ to $T_p$ )   | 3°C/ sec max     |
| Preheat   |                  |
| Temperature min ( $T_S$ mn)                           | 150 °C           |
| Temperature max ( $T_S$ max)                          | 200 °C           |
| Time ( $t_S$ min to $t_S$ max) ( $t_S$ )              | 60-100 sec       |
| Time maintained above:                                |                  |
| Temperature $T_L$                                     | 217 °C           |
| Time $t_L$  | 60-70 sec        |
| Peak temperature ( $T_p$ )                            | 240 + 0 °C       |
| Time within 5 °C of actual peak temperature ( $T_p$ ) | 10-20 sec        |
| Ramp down rate  | 6 °C/sec         |
| Time from 25 °C to peak temperature                   | 8 minutes max    |

Figure 11. Soldering profiles

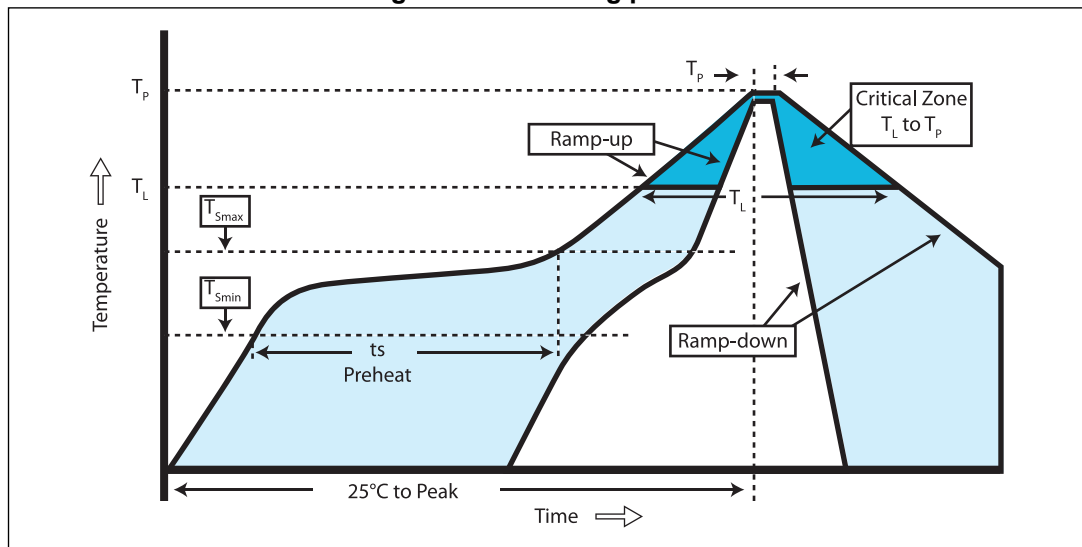

## 6 Regulatory compliance

### 6.1 FCC certification

This module has been tested and found to comply with the FCC part 15 rules. These limits are designed to provide reasonable protection against harmful interference in approved installations. This equipment generates, uses, and can radiate radio frequency energy and, if not installed and used in accordance with the instructions, may cause harmful interference to radio communications.

However, there is no guarantee that interference may not occur in a particular installation.

This device complies with part 15 of the FCC rules. Operation is subject to the following two conditions:

1. This device may not cause harmful interference,  
and
2. this device must accept any interference received, including interference that may cause undesired operation.

Modifications or changes to this equipment not expressly approved by STMicroelectronics may render void the user's authority to operate this equipment.

#### Modular approval

FCC ID: S9NSPBTLERF

In accordance with FCC part 15, the SPBTLE-RF is listed as a modular transmitter device.

This module is evaluated for stand-alone use only. Finished products incorporating multiple transmitters must comply with colocation and RF exposure requirements in accordance with FCC multi-transmitter product procedures. Collocated transmitters operating in portable RF Exposure conditions (e.g. <20 cm from persons including but not limited to body worn and hand held devices) may require separate approval.

#### 6.1.1 Labeling instructions

When integrating the SPBTLE-RF into the final product, the OEM must ensure that the FCC labeling requirements are satisfied. A statement must be included on the exterior of the final product which indicates the product includes a certified module. The label should state the following (or similar wording that conveys the same meaning):

Contains FCC ID: S9NSPBTLERF

OR

This product contains FCC ID: S9NSPBTLERF

The OEM must include the following statements on the exterior of the final product unless the product is too small (e.g. less than 4 x 4 inches):

This device complies with Part 15 of the FCC Rules. Operation is subject to the following two conditions:

1. this device may not cause harmful interference,  
and
2. this device must accept any interference received, including any interference that may cause undesired operation.

### 6.1.2 Product manual instructions

This section applies to OEM final products containing the SPBTLE-RF module, subject to FCC compliance. The final product manual must contain the following statement (or a similar statement that conveys the same meaning):

---

**Warning: Changes or modifications not expressly approved by the party responsible for compliance could void the user's authority to operate the equipment. (Part. 15.21)**

---

In the case where an OEM seeks Class B (residential) limits for the final product, the following statement must be included in the final product manual:

*Note: This equipment has been tested and found to comply with the limits for a Class B digital device, pursuant to part 15 of the FCC Rules. These limits are designed to provide reasonable protection against harmful interference in a residential installation. This equipment generates, uses and can radiate radio frequency energy and, if not installed and used in accordance with the instructions, may cause harmful interference to radio communications. However, there is no guarantee that interference will not occur in a particular installation. If this equipment does cause harmful interference to radio or television reception, which can be determined by turning the equipment off and on, the user is encouraged to try to correct the interference by one or more of the following measures:*

- Reorient or relocate the receiving antenna.
- Increase the separation between the equipment and receiver.
- Connect the equipment into an outlet on a circuit different from that to which the receiver is connected.
- Consult the dealer or an experienced radio/TV technician for help.

In the case where an OEM seeks the lesser category of a Class A digital device for the final product, the following statement must be included in the final product manual:

*Note: This equipment has been tested and found to comply with the limits for a Class A digital device, pursuant to part 15 of the FCC Rules. These limits are designed to provide reasonable protection against harmful interference when the equipment is operated in a commercial environment. This equipment generates, uses, and can radiate radio frequency energy and, if not installed and used in accordance with the instruction manual, may cause harmful interference to radio communications. Operation of this equipment in a residential area is likely to cause harmful interference in which case the user will be required to correct the interference at his expense.*

## 6.2 IC certification

The SPBTLE-RF module has been tested and found compliant with the IC RSS-210 rules. These limits are designed to provide reasonable protection against harmful interference in



approved installations. This equipment generates, uses, and can radiate radio frequency energy and, if not installed and used in accordance with the instructions, may cause harmful interference to radio communications.

However, there is no guarantee that interference may not occur in a particular installation.

This device complies with RSS-210 of the IC rules. Operation is subject to the following two conditions:

1. this device may not cause harmful interference,
- and
2. this device must accept any interference received, including interference that may cause undesired operation.

Modifications or changes to this equipment not expressly approved by STMicroelectronics may render void the user's authority to operate this equipment.

### **Modular approval**

IC: 8976C-SPBTLERF

In accordance with IC RSS-210, the SPBTLE-RF is listed as a modular transmitter device.

This module is evaluated for stand-alone use only. Finished products incorporating multiple transmitters must comply with colocation and RF exposure requirements in accordance with IC multi-transmitter product procedures. Collocated transmitters operating in portable RF Exposure conditions (e.g. <20cm from persons including but not limited to body worn and hand held devices) may require separate approval.

## **6.2.1 Labeling instructions**

When integrating the SPBTLE-RF into the final product, the OEM must ensure that the IC labeling requirements are satisfied. A statement must be included on the exterior of the final product which indicates that the product includes a certified module. The label should state the following (or similar wording that conveys the same meaning):

Contains IC: 8976C-SPBTLERF

OR

This product contains IC: 8976C-SPBTLERF

The OEM must include the following statements on the exterior of the final product unless the product is too small (e.g. less than 4 x 4 inches):

This device complies with RSS-210 of the IC Rules. Operation is subject to the following two conditions:

1. this device may not cause harmful interference,
- and
2. this device must accept any interference received, including any interference that may cause undesired operation.

## 6.2.2 Product manual instructions

This section applies to OEM final products containing the SPBTLE-RF module, subject to IC compliance. The final product manual must contain the following statement (or a similar statement that conveys the same meaning):

---

**Warning: Changes or modifications not expressly approved by the party responsible for compliance could void the user's authority to operate the equipment. (RSS-210)**

---

In the case where an OEM seeks Class B (residential) limits for the final product, the following statement must be included in the final product manual:

*Note: This equipment has been tested and found to comply with the limits for a Class B digital device, pursuant to RSS-210 of the IC Rules. These limits are designed to provide reasonable protection against harmful interference in a residential installation. This equipment generates, uses and can radiate radio frequency energy and, if not installed and used in accordance with the instructions, may cause harmful interference to radio communications. However, there is no guarantee that interference will not occur in a particular installation. If this equipment does cause harmful interference to radio or television reception, which can be determined by turning the equipment off and on, the user is encouraged to try to correct the interference by one or more of the following measures:*

- Reorient or relocate the receiving antenna.
- Increase the separation between the equipment and receiver.
- Connect the equipment into an outlet on a circuit different from that to which the receiver is connected.
- Consult the dealer or an experienced radio/TV technician for help.

In the case where an OEM seeks the lesser category of a Class A digital device for the final product, the following statement must be included in the final product manual:

*Note: This equipment has been tested and found to comply with the limits for a Class A digital device, pursuant to RSS-210 of the IC Rules. These limits are designed to provide reasonable protection against harmful interference when the equipment is operated in a commercial environment. This equipment generates, uses, and can radiate radio frequency energy and, if not installed and used in accordance with the instruction manual, may cause harmful interference to radio communications. Operation of this equipment in a residential area is likely to cause harmful interference in which case the user will be required to correct the interference at his expense.*

## 6.3 CE certification

The module has been certified according to the following certification rules:

- EN 300 328 V 2.1.1 (2016-11)<sup>(a)</sup>
- ETSI EN 301 489-17 V3.1.1 (2017-02)<sup>(b)</sup>
- ETSI EN 301 489-1 V2.1.1 (2017-02)<sup>(c)</sup>
- EN 60950-1:2006 + A11:2009 + A1:2010 + A12:2011 + A2:2013<sup>(d)</sup>
- EN 62479:2010

The module is provided by CE marking:



The module has obtained the RED certificate: No. 0051-RED-0011 REV. 0

The certified module production firmware release is: **7.X**

For additional information please refer to:

**STMicroelectronics Via C. Olivetti 2, Agrate Brianza 20864 (ITALY)**

## 6.4 Bluetooth certification

The module with embedded stack and profile has been qualified in accordance with SIG qualification rules:

- Declaration ID: D028766
- Qualified design ID: 71984
- Product type: End Product
- Core spec version: 4.1
- Product description: Bluetooth low energy v4.1 module

## 6.5 TELEC certification

Module has been tested according to following TELEC certification rules:

Type of specified radio equipment

- Radio equipment according to certification ordinance article 2-1-9

Sophisticated low power radio data communication system in 2.4 GHz band.

Class of emissions, assigned frequency, and antenna power

- F1D, G1D 2441 MHz channel separation 2 MHz/40 channel, 0.0025 W

Certification number

- 006-000395

Design and manufacturing are certified based on Japan radio law 38-24.

- 
- EN 300 328 V 2.1.1 (2016 11): "electromagnetic compatibility and radio spectrum Matters (ERM); Wideband transmission systems; data transmission equipment operating in the 2.4 GHz ISM band and using wideband modulation techniques; harmonized EN covering essential requirements under article 3.2 of the R&TTE directive".
  - EN 301 489-17 V 3.1.1 (2017 02): "electromagnetic compatibility and radio spectrum Matters (ERM); electromagnetic compatibility (EMC) standard for radio equipment and services; part 17: specific condition for 2.4 GHz wideband transmission systems and 5 GHz high performance RLAN equipment".
  - ETSI EN 301 489-1 V2.1.1 (2017 02): "electromagnetic compatibility and radio spectrum Matters (ERM); electromagnetic compatibility (EMC) standard for radio equipment and services; part 1: Common technical requirements".
  - EN60950-1:2006 +A11:2009+A1:2010+A12:2011+A2:2013: "Information technology equipment - safety".

## 7 Ordering information

**Table 7. Ordering information**

| <b>Order code</b> | <b>Description</b>                | <b>Packing</b> | <b>MOQ</b> |
|-------------------|-----------------------------------|----------------|------------|
| SPBTLE-RF         | Bluetooth® V4.1 low energy module | JEDEC tray     | 2448 pcs   |
| SPBTLE-RFTR       | Bluetooth® V4.1 low energy module | Tape and reel  | 1000 pcs   |

## 8 ECOPACK®

In order to meet environmental requirements, ST offers these devices in different grades of ECOPACK® packages, depending on their level of environmental compliance. ECOPACK® specifications, grade definitions and product status are available at: [www.st.com](http://www.st.com). ECOPACK® is an ST trademark.

## 9 Traceability

Each module is univocally identified by serial number stored in a 2D data matrix laser marked on the bottom side of the module itself.

The serial number has the following format:

**Table 8. Traceability information**

| Letter | Meaning                                    |
|--------|--|
| WW     | Week                                       |
| YY     | Year                                       |
| D      | Product ID family                          |
| FF     | Production panel coordinate identification |
| NNN    | Progressive serial number.                 |

Each module bulk is identified by a bulk ID.

BULK ID and module 2D data matrix are linked by a reciprocal traceability link.

The module 2D data matrix traces the lot number of any raw material used.

## 10 Revision history

**Table 9. Document revision history**

| Date        | Revision | Changes   |
|-------------|----------|---|
| 07-May-2015 | 1        | Initial release.  |
| 09-Jul-2015 | 2        | Inserted: <i>Section 4.3</i> and <i>Section 4.4</i> .   |
| 03-Nov-2015 | 3        | – Document status promoted from preliminary data to production data.<br>– Added <i>Section 6.4: Bluetooth certification</i> . |
| 17-Dec-2015 | 4        | Updated figure on the cover page.   |
| 11-Jan-2016 | 5        | Updated BQE feature on the cover page.  |
| 08-Jun-2016 | 6        | Added paragraph regarding firmware update in <i>Section 1: General description</i> .  |
| 27-Mar-2017 | 7        | Added new paragraph <i>Section 6.5: TELEC certification</i> .   |
| 12-Apr-2017 | 8        | Updated figure on the cover page.   |
| 07-Jul-2017 | 9        | Updated <i>Table 7</i> .  |
| 04-Oct-2017 | 10       | Updated <i>Section 6.3: CE certification for SPBTLE-RF module</i> .   |

**IMPORTANT NOTICE – PLEASE READ CAREFULLY**

STMicroelectronics NV and its subsidiaries (“ST”) reserve the right to make changes, corrections, enhancements, modifications, and improvements to ST products and/or to this document at any time without notice. Purchasers should obtain the latest relevant information on ST products before placing orders. ST products are sold pursuant to ST’s terms and conditions of sale in place at the time of order acknowledgement.

Purchasers are solely responsible for the choice, selection, and use of ST products and ST assumes no liability for application assistance or the design of Purchasers’ products.

No license, express or implied, to any intellectual property right is granted by ST herein.

Resale of ST products with provisions different from the information set forth herein shall void any warranty granted by ST for such product.

ST and the ST logo are trademarks of ST. All other product or service names are the property of their respective owners.

Information in this document supersedes and replaces information previously supplied in any prior versions of this document.

© 2017 STMicroelectronics – All rights reserved

## X-ON Electronics

Largest Supplier of Electrical and Electronic Components

*Click to view similar products for [Bluetooth Modules - 802.15.1 category](#):*

*Click to view products by [STMicroelectronics manufacturer](#):*

Other Similar products are found below :

[A2541R24A10GM](#) [CYBLE-212023-10](#) [BM78SPP05NC2-0002AA](#) [BM78SPP05MC2-0002AA](#) [CYW20732S](#) [968EMB0019](#) [E73-2G4M08S1CX](#) [TB-03F](#) [TB-03F-AT\\_Mesh](#) [TB-04](#) [TB-04--AT\\_Mesh](#) [BT3L\(jibu\)](#) [BT5S\(xoft\)](#) [BT5S\(4k43\)](#) [BT5S\(jcyv\)](#) [1327](#) [RN42HID-I/RM](#) [ENW-89829C3KF](#) [BLE113-A-V1](#) [BM70BLE01FC2-0B03AA](#) [ACN52832](#) [A2541E24A10GM](#) [RN42-I/RM630](#) [450-0168R](#) [MOTG-BLUETOOTH](#) [ABBTM-2.4GHz-52-T](#) [ABBTM-2.4GHz-T](#) [ABBTM-2.4GHz-T2](#) [4076](#) [AFERO-BL24-01](#) [BLED112](#) [BM62SPKS1MC2-0001AA](#) [BM78SPPS5MC2-0002AA](#) [PX0880/1](#) [CYBLE-224110-00](#) [DAT12](#) [BT680F](#) [PBA31309V1.00](#) [S LK64](#) [ATSAMB11-MR510CA](#) [BM20SPKA1NBC-0001AA](#) [BM20SPKS1NBC-0001AA](#) [BM23SPKS1NB9-0B02AA](#) [BM64SPKS1MC2-0002AA](#) [BM70BLE01FC2-0B04AA](#) [BM70BLE01FC2-0B05BA](#) [BM77SPP03MC2-0007AA](#) [BM77SPP03MC2-0008AA](#) [BM78SPP05NC2-0001AA](#) [BM78SPPS5NC2-0002AA](#) [BM83SM1-00TA](#)