

Sub-GHz (868 or 915 MHz) low power programmable RF transceiver modules

Datasheet - production data

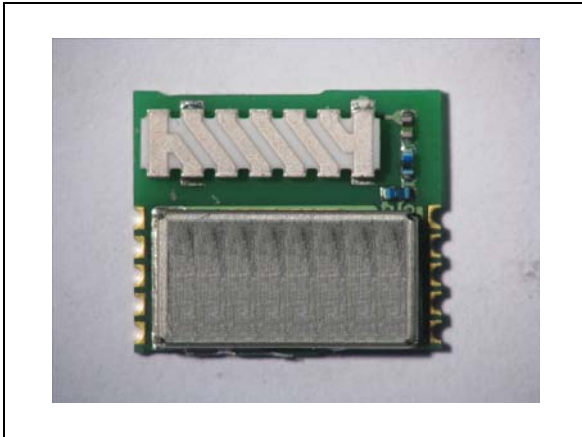

Features

- Programmable radio features
 - Based on Sub-1GHz SPIRIT1 transceiver and integrated Balun (BALF-SPI-01D3)
 - Modulation schemes: 2-FSK, GFSK, MSK, GMSK, OOK, ASK
 - Air data rate from 1 to 500 kbps
 - On-board antenna
 - Operating temperature range from -40 °C to 85 °C
- RF features
 - Receiver sensitivity: -118 dBm
 - Programmable RF output power up to +11.6 dBm
- Host interface
 - SPI
- General I/O
 - Up to 32 programmable I/O functions on 4 GPIO programmable module pins
- Two typical carrier frequency versions:
 - SPSGRF-868 with 868 MHz tuned antenna
 - SPSGRF-915 with 915 MHz tuned antenna

- Certification:
 - CE (SPSGRF-868)
 - FCC (SPSGRF-915)
 - IC (SPSGRF-915)

Applications

- AMR (automatic meter reading)
- Home and building automation
- WSN (wireless sensor network)
- Industrial monitoring and control
- Wireless fire and security alarm systems
- Point-to-point wireless link

Description

The SPSGRF-868 and SPSGRF-915 are easy-to-use, low power sub-GHz modules based on the SPIRIT1 RF transceiver, operating respectively in the 868 MHz SRD and 915 MHz ISM bands.

The modules provide a complete RF platform in a tiny form factor.

The SPSGRF series enables wireless connectivity in electronic devices, requiring no RF experience or expertise for integration into the final product. As an FCC, IC, and CE certified solution, the SPSGRF series optimizes the time-to-market of end applications. The SPSGRF-915 is an FCC certified module (FCC ID: S9NSPSGRF) and IC certified (IC 8976C-SPSGRF), while the SPSGRF-868 is certified CE.

The modules are designed for maximum performance in minimal space and include 4 programmable I/O pins and SPI serial interfaces.

Contents

- 1 Block diagram 3**
- 2 SPSGRF module functional behavior 4**
- 3 Hardware specifications 5**
 - 3.1 Absolute maximum ratings 5
 - 3.2 Recommended operating conditions 5
 - 3.3 Module current consumption 5
 - 3.4 Module RF compliance limits 6
 - 3.5 SPSGRF module RF typical performance 7
 - 3.6 Pin connections 10
- 4 Mechanical dimensions 11**
- 5 Hardware design 12**
 - 5.1 Reflow soldering 12
- 6 Regulatory compliance 14**
 - 6.1 FCC certification 14
 - 6.1.1 Labeling instructions 14
 - 6.1.2 Product manual instructions 15
 - 6.2 IC certification 15
 - 6.2.1 Labeling instructions 16
 - 6.2.2 Product manual instructions 16
 - 6.3 CE certification 18
- 7 Module traceability and marking 19**
- 8 Ordering information 21**
- 9 ECOPACK® 22**
- 10 Revision history 23**

1 Block diagram

Figure 1. SPSGRF block diagram

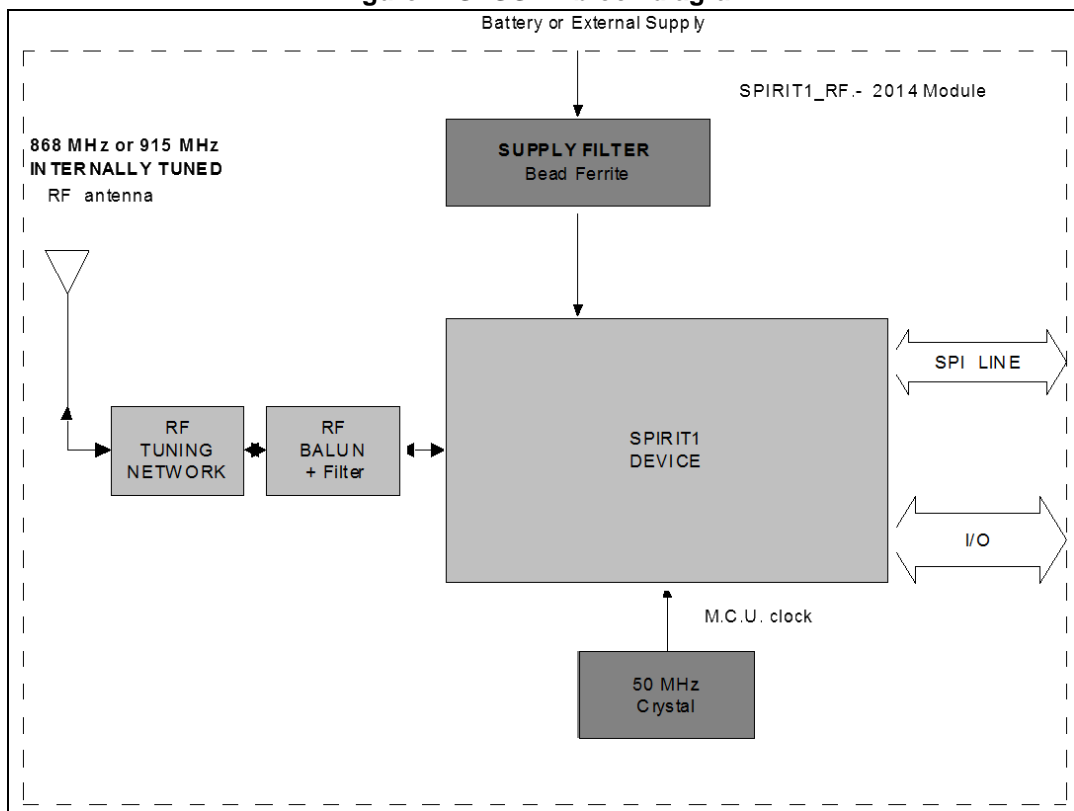

2 SPSGRF module functional behavior

The SPIRIT1 device in the SPSGRF module is equipped with a built-in main controller which controls the switching between the two main operating modes: transmit (TX) and receive (RX).

In shutdown condition, the SPSGRF module can be switched on/off with the external SDN pin; all other functions/registers/commands are available through the SPI interface and GPIOs. No internal supply is generated (in order to minimize battery leakage), and therefore all stored data and configurations are lost.

The GPIO and SPI ports of the module during shutdown are in HiZ. From the SHUTDOWN state, the SPSGRF module can be switched on from the SDN pin and goes into a READY state, which is the default, where the reference signal from XO is available.

From the READY state, the SPSGRF module can be moved to a LOCK state to generate the high precision LO signal and/or TX or RX modes. Switching from RX to TX and vice-versa can occur only by passing through the LOCK state. This operation is normally managed by radio control with a single user command (TX or RX).

At the end of the events above, the SPSGRF module can return to its default state (READY) and can then be put into a sleep condition (SLEEP state), characterized by very low power consumption.

If no timeout is required, the SPSGRF module can be moved from READY to STANDBY state, which has the lowest possible current consumption while retaining FIFO, status and configuration registers. To manage the transitions towards and between these operating modes, the controller works as a state machine, the state switching of which is driven by SPI commands.

Figure 2. Module functional state transitions diagram

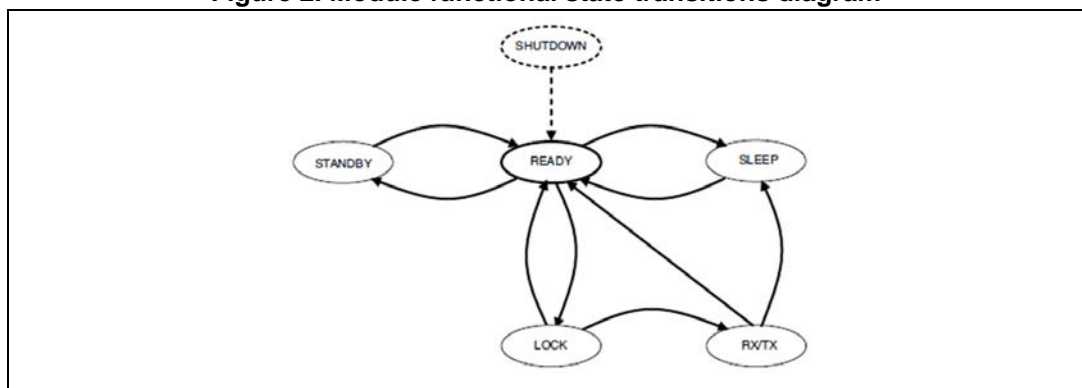

3 Hardware specifications

3.1 Absolute maximum ratings

General conditions (V_{IN} = 3.3 V and 25 °C)

Table 1. Absolute maximum ratings

Rating	Min.	Typ.	Max.	Unit
Storage temperature range	-40		+85	°C
Supply voltage, V_{IN}	-0.3		3.9	V
I/O pin voltage	-0.3		3.9	V
RF saturation input power		+10		dBm

3.2 Recommended operating conditions

Table 2. Recommended operating conditions

Rating	Min.	Typ.	Max.	Unit
Operating temperature range	-40		+85	°C
Supply voltage, V_{IN}	1.8	3.3	3.6	V
Signals & I/O pin voltage (according supply voltage)	1.8		3.6	V
RF frequency bandwidth (SPSGRF-868)	863		870	MHz
RF frequency bandwidth (SPSGRF-915)	902		928	MHz

3.3 Module current consumption

Table 3. SPSGRF-868 module

Symbol	Parameter	Test conditions	Typ.	Unit
I_{DD}	Supply current	Operating mode Tx, +11.6 dBm, 2-FSK, 868 MHz	22	mA
		Operating mode Tx, - 7 dBm, 2-FSK, 868 MHz	9	mA
		Operating mode Rx, 868MHz	10	mA
		Command mode	0.6	mA
		Shutdown high level $-V_{DD}$ (with other I/O in High impedance)	0.1	μA

Table 4. SPSGRF-915 module

Symbol	Parameter	Test conditions	Typ.	Unit
I _{DD}	Supply current	Operating mode Tx, +11.6 dBm, 2-FSK, 915 MHz	22	mA
		Operating mode Tx, - 7 dBm, 2-FSK, 915 MHz	9	mA
		Operating mode Rx, 915 MHz	10	mA
		Command mode	0.6	mA
		Shutdown high level -V _{DD} (with other I/O in high impedance)	0.1	µA

3.4 Module RF compliance limits

The RF compliance limits are those tested for FCC, IC and CE certification using the dedicated dongle (PC92A.V01). These limits are enforced by the dongle firmware. Care must be taken with custom application firmware to ensure these limits are not exceeded, voiding the FCC, IC and CE certification.

Table 5. RF compliance limits table

Modulation	Standards	Parameter	Max.	Unit
2-FSK GFSK MSK	FCC Part 15.207 ⁽¹⁾ FCC Part 15.247 ⁽¹⁾ IC RSS-210 ETSI EN 301 489-3 V2.1.1 ETSI EN 301 489-1 V2.2.3 ETSI EN 300 220-2 V3.2.1	Data rate	500	kbps
		Output power	+11.6	dBm
OOK ASK	FCC Part 15.207 ⁽¹⁾ FCC Part 15.247 ⁽¹⁾ IC RSS-210 ETSI EN 301 489-3 V2.1.1 ETSI EN 301 489-1 V2.2.3 ETSI EN 300 220-2 V3.2.1	Data rate	250	kbps
		Output power	+6	dBm

1. FCC and IC standards are applicable only to the SPSGRF-915 module.

3.5 SPSGRF module RF typical performance

The RF performance of the SPSGRF-868 and SPSGRF-915 modules are dependent on many factors, related to the customer hardware application board where the module is connected and also to the customer application firmware. In order to provide some basic information to the customer integrating the module, it may be useful to provide the RF measurements taken in an anechoic chamber using a dongle containing a connected SPSGRF-868 or SPSGRF-915 module.

Table 6. SPSGRF-868 or 915 modules radiated typical performance

Symbol	Parameter	Test conditions	Typ.	Unit
Tx RF power	RF radiated power	Operating mode Tx, +11.6 dBm, 2-FSK, 868,0-868,6 MHz	+5.3	dBm
		Operating mode Tx, +11.6 dBm, 2-FSK, 902-928 MHz	+2.2	dBm

Table 7. SPSGRF-868 or 915 module conducted typical performance before the RF antenna circuits (positive RF power signal values measured)

Parameter	Test conditions ⁽¹⁾	Conducted programmable value	Measured conducted value Typ.	Unit
Tx RF conducted power (before the antenna circuits)	Tx, +11.6 dBm, 2-FSK, 868 MHz Tx, +11.6 dBm, 2-FSK, 915 MHz	+11.6	+11.2	dBm
	Tx, +11 dBm, 2-FSK, 868 MHz Tx, +11 dBm, 2-FSK, 915 MHz	+11.0	+10.8	dBm
	Tx, +10 dBm, 2-FSK, 868 MHz Tx, +10 dBm, 2-FSK, 915 MHz	+10.0	+9.7	dBm
	Tx, +9 dBm, 2-FSK, 868 MHz Tx, +9 dBm, 2-FSK, 915 MHz	+9.0	+8.5	dBm
	Tx, +8 dBm, 2-FSK, 868 MHz Tx, +8 dBm, 2-FSK, 915 MHz	+8.0	+7.6	dBm
	Tx, +7 dBm, 2-FSK, 868 MHz Tx, +7 dBm, 2-FSK, 915 MHz	+7.0	+7.2	dBm
	Tx, +6 dBm, 2-FSK, 868 MHz Tx, +6 dBm, 2-FSK, 915 MHz	+6.0	+6.2	dBm
	Tx, +5 dBm, 2-FSK, 868 MHz Tx, +5 dBm, 2-FSK, 915 MHz	+5.0	+5.4	dBm
	Tx, +4 dBm, 2-FSK, 868 MHz Tx, +4 dBm, 2-FSK, 915 MHz	+4.0	+4.0	dBm
	Tx, +3 dBm, 2-FSK, 868 MHz Tx, +3 dBm, 2-FSK, 915 MHz	+3.0	+3.1	dBm
	Tx, +2 dBm, 2-FSK, 868 MHz Tx, +2 dBm, 2-FSK, 915 MHz	+2.0	+2.1	dBm
	Tx, +1 dBm, 2-FSK, 868 MHz Tx, +1 dBm, 2-FSK, 915 MHz	+1.0	+1.2	dBm
	Tx, +0 dBm, 2-FSK, 868 MHz Tx, +0 dBm, 2-FSK, 915 MHz	+0.0	+0.6	dBm

1. Operating mode

Table 8. SPSGRF-868 or 915 module conducted typical performance before the RF antenna circuits (negative RF power signal values measured)

Parameter	Test conditions ⁽¹⁾	Conducted programmable value	Measured conducted value Typ.	Unit
Tx RF conducted power (before the antennas circuits)	Tx, -1 dBm, 2-FSK, 868 MHz Tx, -1 dBm, 2-FSK, 915 MHz	-1.0	-1.1	dBm
	Tx, -2 dBm, 2-FSK, 868 MHz Tx, -2 dBm, 2-FSK, 915 MHz	-2.0	-2.3	dBm
	Tx, -3 dBm, 2-FSK, 868 MHz Tx, -3 dBm, 2-FSK, 915 MHz	-3.0	-3.4	dBm
	Tx, -4 dBm, 2-FSK, 868 MHz Tx, -4 dBm, 2-FSK, 915 MHz	-4.0	-4.9	dBm
	Tx, -5 dBm, 2-FSK, 868 MHz Tx, -5 dBm, 2-FSK, 915 MHz	-5.0	-5.8	dBm
	Tx, -6 dBm, 2-FSK, 868 MHz Tx, -6 dBm, 2-FSK, 915 MHz	-6.0	-6.9	dBm
	Tx, -7 dBm, 2-FSK, 868 MHz Tx, -7 dBm, 2-FSK, 915 MHz	-7.0	-6.5	dBm
	Tx, -8 dBm, 2-FSK, 868 MHz Tx, -8 dBm, 2-FSK, 915 MHz	-8.0	-7.3	dBm
	Tx, -9 dBm, 2-FSK, 868 MHz Tx, -9 dBm, 2-FSK, 915 MHz	-9.0	-8.2	dBm
	Tx, -10 dBm, 2-FSK, 868 MHz Tx, -10 dBm, 2-FSK, 915 MHz	-10.0	-9.7	dBm
	Tx, -15 dBm, 2-FSK, 868 MHz Tx, -15 dBm, 2-FSK, 915 MHz	-15.0	-14.6	dBm
	Tx, -20 dBm, 2-FSK, 868 MHz Tx, -20 dBm, 2-FSK, 915 MHz	-20.0	-19.2	dBm
	Tx, -25 dBm, 2-FSK, 868 MHz Tx, -25 dBm, 2-FSK, 915 MHz	-25.0	-23.3	dBm
	Tx, -30 dBm, 2-FSK, 868 MHz Tx, -30 dBm, 2-FSK, 915 MHz	-30.0	-26.2	dBm
Tx, -35 dBm, 2-FSK, 868 MHz Tx, -35 dBm, 2-FSK, 915 MHz	-35.0	-27.8	dBm	

1. Operating mode

3.6 Pin connections

Figure 3. Pin connection diagram

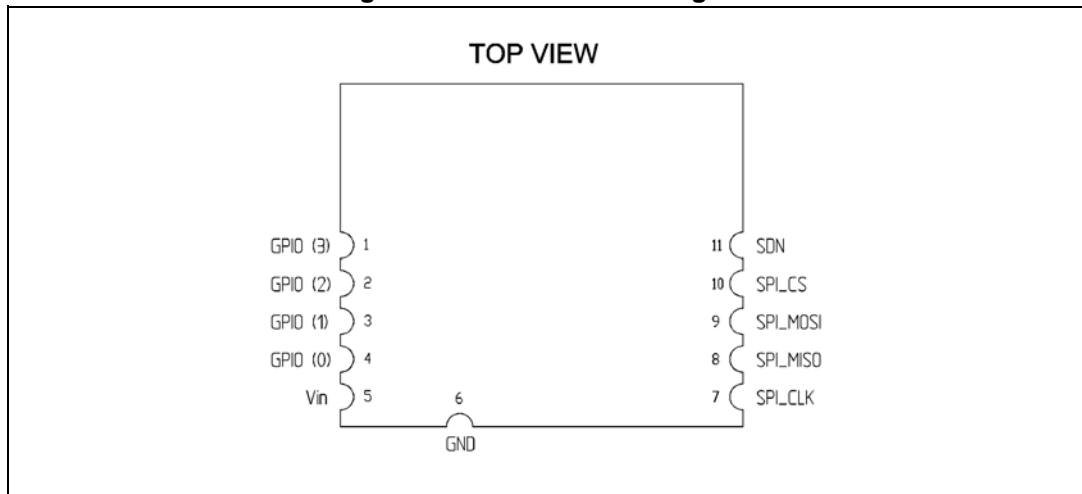

Table 9. Pin assignment

Name	Type	Pin#	Description	Alt function	V max. tolerance	Initial state
SPI interface						
SPI_CLK	I	7	SPI CLOCK (Max. 8 MHz)		V _{in}	
SPI_MISO	O	8	SPI MISO (MASTER in / SLAVE out)		V _{in}	
SPI_MOSI	I	9	SPI MOSI (MASTER out SLAVE in)		V _{in}	
SPI_CS	I	10	SPI "Chip Select" (SPI slave select)		V _{in}	
Power and ground						
V _{in}		5	V _{in}		(1.8V - 3.6V max.)	
GND		6	GND			
Module shutdown						
SDN	I	11	Shutdown input (active high)		(1.8V - 3.6V max.)	
GPIO - general purpose input/output						
GPIO [0]	I/O	4	Programmable input / output & analog temperature output		(1.8V - V _{in} max.)	Digital output. Low power
GPIO [1]	I/O	3	Programmable input / output		(1.8V - V _{in} max.)	Digital output. Low power
GPIO [2]	I/O	2	Programmable input / output		(1.8V - V _{in} max.)	Digital output. Low power
GPIO [3]	I/O	1	Programmable input / output		(1.8V - V _{in} max.)	Digital output. Low power

4 Mechanical dimensions

Figure 4. Mechanical dimensions

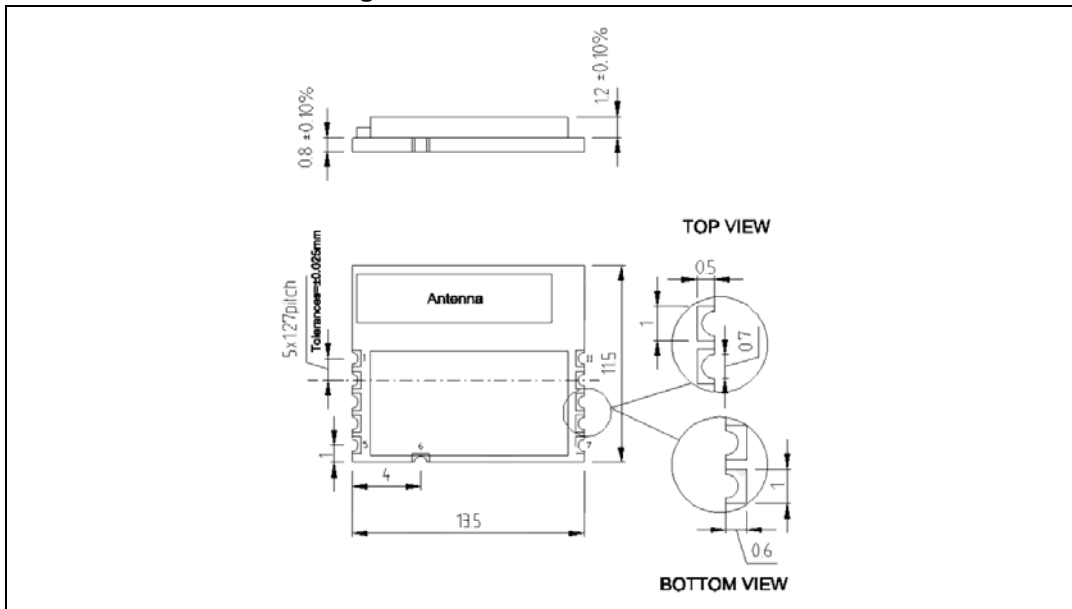
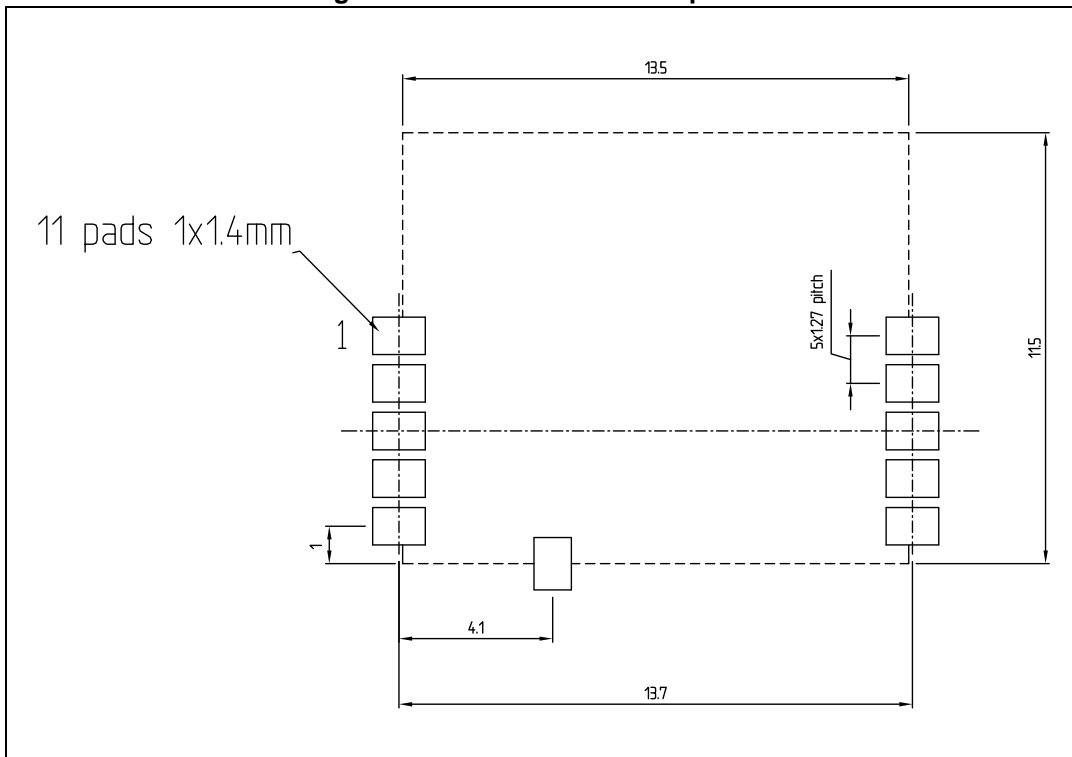

Figure 5. Recommended land pattern



5 Hardware design

The SPSGRF module supports SPI hardware interfaces.

- Note:*
- All unused pins should be left floating; do not ground.
 - All GND pins must be well grounded.
 - The area around the module should be free of any ground planes, power planes, trace routings, or metal for 6 mm from the module antenna position, in all directions.
 - Traces should not be routed underneath the module

5.1 Reflow soldering

The SPSGRF is a surface mount sub-1 GHz transceiver module supplied on an 11 pin, 4-layer PCB. The final assembly recommended reflow profiles are indicated below.

The soldering phase must be executed with care. In order to avoid an undesired melting phenomenon, particular attention should be given to the setup of the peak temperature.

[Table 10](#) provides suggestions for the temperature profile based on IPC/JEDEC J-STD-020C, July 2004 recommendations.

Table 10. Soldering recommendations

Profile feature	PB-free assembly
Average ramp up rate ($T_{S\text{MAX}}$ to T_p)	3°C/ sec max
Preheat	
Temperature min (T_S min)	150 °C
Temperature max (T_S max)	200 °C
Time (t_S min to t_S max) (t_S)	60-100 sec
Time maintained above:	
Temperature T_L	217 °C
Time t_L	60-70 sec
Peak temperature (T_p)	240 + 0 °C
Time within 5 °C of actual peak temperature (t_p)	10-20 sec
Ramp down rate	6 °C/sec
Time from 25 °C to peak temperature	8 minutes max

Figure 6. Soldering profile

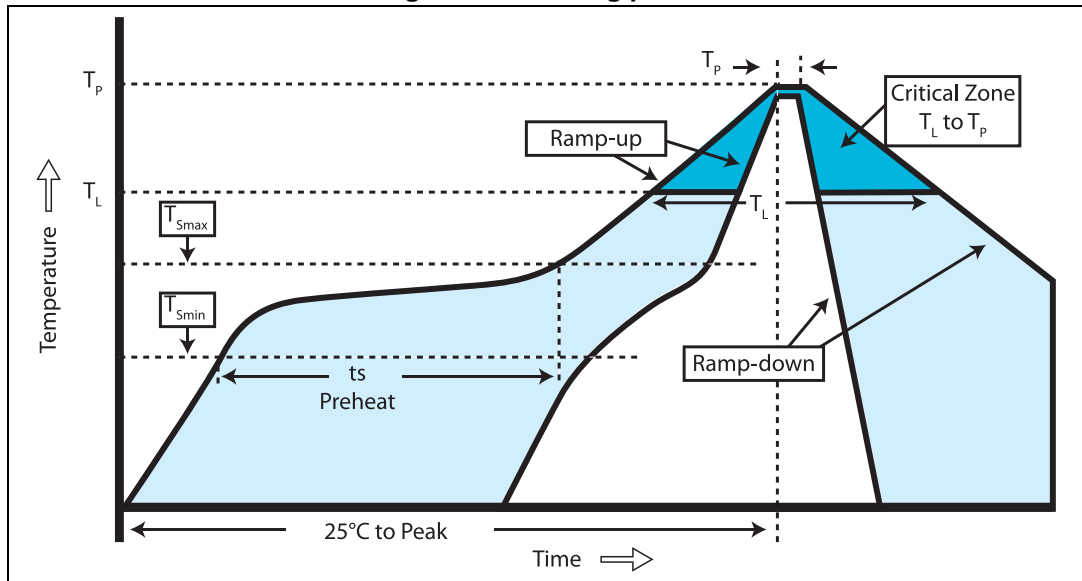

6 Regulatory compliance

6.1 FCC certification

The SPSGRF-915 module has been tested and found compliant with the FCC part 15 rules. These limits are designed to provide reasonable protection against harmful interference in approved installations. This equipment generates, uses, and can radiate radio frequency energy and, if not installed and used in accordance with the instructions, may cause harmful interference to radio communications.

However, there is no guarantee that interference may not occur in a particular installation.

This device complies with part 15 of the FCC rules. Operation is subject to the following two conditions: (1) this device may not cause harmful interference, and (2) this device must accept any interference received, including interference that may cause undesired operation.

Modifications or changes to this equipment not expressly approved by STMicroelectronics may render void the user's authority to operate this equipment.

Modular approval

FCC ID: S9NSPSGRF

In accordance with FCC part 15, the SPSGRF-915 is listed as a modular transmitter device.

This module is evaluated for stand-alone use only. Finished products incorporating multiple transmitters must comply with collocation and RF exposure requirements in accordance with FCC multi-transmitter product procedures. Collocated transmitters operating in portable RF exposure conditions (e.g. <20 cm from persons including but not limited to body worn and hand-held devices) may require separate approval.

6.1.1 Labeling instructions

When integrating the SPSGRF-915 into the final product, the OEM must ensure that the FCC labeling requirements are satisfied. A statement must be included on the exterior of the final product which indicates that the product includes a certified module. The label should state the following (or similar wording that conveys the same meaning):

Contains FCC ID: S9NSPSGRF

OR This product contains FCC ID: S9NSPSGRF

The OEM must include the following statements on the exterior of the final product unless the product is too small (e.g. less than 4 x 4 inches):

This device complies with part 15 of the FCC rules. Operation is subject to the following two conditions:

1. this device may not cause harmful interference
2. this device must accept any interference received, including any interference that may cause undesired operation.

6.1.2 Product manual instructions

This section applies to OEM final products containing the SPSGRF-915 module, subject to FCC compliance. The final product manual must contain the following statement (or a similar statement that conveys the same meaning):

“Warning: Changes or modifications not expressly approved by the party responsible for compliance could void the user’s authority to operate the equipment. (Part. 15.21)”

In the case where an OEM seeks Class B (residential) limits for the final product, the following statement must be included in the final product manual:

“Note: This equipment has been tested and found to comply with the limits for a Class B digital device, pursuant to part 15 of the FCC Rules. These limits are designed to provide reasonable protection against harmful interference in a residential installation. This equipment generates, uses and can radiate radio frequency energy and, if not installed and used in accordance with the instructions, may cause harmful interference to radio communications. However, there is no guarantee that interference will not occur in a particular installation. If this equipment does cause harmful interference to radio or television reception, which can be determined by turning the equipment off and on, the user is encouraged to try to correct the interference by one or more of the following measures:

- Reorient or relocate the receiving antenna.*
- Increase the separation between the equipment and receiver.*
- Connect the equipment into an outlet on a circuit different from that to which the receiver is connected.*
- Consult the dealer or an experienced radio/TV technician for help.”*

In the case where an OEM seeks the lesser category of a Class A digital device for the final product, the following statement must be included in the final product manual:

“Note: This equipment has been tested and found to comply with the limits for a Class A digital device, pursuant to part 15 of the FCC Rules. These limits are designed to provide reasonable protection against harmful interference when the equipment is operated in a commercial environment. This equipment generates, uses, and can radiate radio frequency energy and, if not installed and used in accordance with the instruction manual, may cause harmful interference to radio communications. Operation of this equipment in a residential area is likely to cause harmful interference in which case the user will be required to correct the interference at his expense.”

6.2 IC certification

The SPSGRF-915 module has been tested and found compliant with the IC RSS-210 rules. These limits are designed to provide reasonable protection against harmful interference in approved installations. This equipment generates, uses, and can radiate radio frequency energy and, if not installed and used in accordance with the instructions, may cause harmful interference to radio communications.

However, there is no guarantee that interference may not occur in a particular installation.

This device complies with RSS-210 of the IC rules. Operation is subject to the following two conditions: (1) this device may not cause harmful interference, and (2) this device must accept any interference received, including interference that may cause undesired operation.

Modifications or changes to this equipment not expressly approved by STMicroelectronics may render void the user's authority to operate this equipment.

Modular approval

IC: 8976C-SPSGRF

In accordance with IC RSS-210, the SPSGRF-915 is listed as a modular transmitter device.

This module is evaluated for stand-alone use only. Finished products incorporating multiple transmitters must comply with collocation and RF exposure requirements in accordance with IC multi-transmitter product procedures. Collocated transmitters operating in portable RF exposure conditions (e.g. <20 cm from persons including but not limited to body worn and hand-held devices) may require separate approval.

6.2.1 Labeling instructions

When integrating the SPSGRF-915 into the final product, the OEM must ensure that the IC labeling requirements are satisfied. A statement must be included on the exterior of the final product which indicates that the product includes a certified module. The label should state the following (or similar wording that conveys the same meaning):

Contains IC ID: 8976C-SPSGRF

OR This product contains IC ID: 8976C-SPSGRF

The OEM must include the following statements on the exterior of the final product unless the product is too small (e.g. less than 4 x 4 inches):

"This device complies with RSS-210 of the IC Rules. Operation is subject to the following two conditions:

- 1. this device may not cause harmful interference*
- 2. this device must accept any interference received, including any interference that may cause undesired operation."*

6.2.2 Product manual instructions

This section applies to OEM final products containing the SPSGRF-915 module, subject to IC compliance. The final product manual must contain the following statement (or a similar statement that conveys the same meaning):

"Warning: Changes or modifications not expressly approved by the party responsible for compliance could void the user's authority to operate the equipment. (RSS-210)"

In the case where an OEM seeks Class B (residential) limits for the final product, the following statement must be included in the final product manual:

"Note: This equipment has been tested and found to comply with the limits for a Class B digital device, pursuant to RSS-210 of the IC Rules. These limits are designed to provide reasonable protection against harmful interference in a residential installation. This equipment generates, uses and can radiate radio frequency energy and, if not installed and used in accordance with the instructions, may cause harmful interference to radio communications. However, there is no guarantee that interference will not occur in a particular installation. If this equipment does cause harmful interference to radio or

television reception, which can be determined by turning the equipment off and on, the user is encouraged to try to correct the interference by one or more of the following measures:

- Reorient or relocate the receiving antenna.
- Increase the separation between the equipment and receiver.
- Connect the equipment into an outlet on a circuit different from that to which the receiver is connected.
- Consult the dealer or an experienced radio/TV technician for help.”

In the case where an OEM seeks the lesser category of a Class A digital device for the final product, the following statement must be included in the final product manual:

“Note: This equipment has been tested and found to comply with the limits for a Class A digital device, pursuant to RSS-210 of the IC Rules. These limits are designed to provide reasonable protection against harmful interference when the equipment is operated in a commercial environment. This equipment generates, uses, and can radiate radio frequency energy and, if not installed and used in accordance with the instruction manual, may cause harmful interference to radio communications. Operation of this equipment in a residential area is likely to cause harmful interference in which case the user will be required to correct the interference at his expense.”

6.3 CE certification

The module has been certified according to the following certification rules:

- EN 62479:2010
- EN 62368-1:2020+A11:2020
- ETSI EN 301 489-3 V2.1.1
- ETSI EN 301 489-1 V2.2.3
- ETSI EN 300 220-2 V3.2.1
- ETSI EN 300 220-1 V3.1.1

The module is provided by CE marking:



The SPSGRF-868 module has obtained the RED certificate: No. 0051-RED-0024

For additional information please refer to:

STMicroelectronics Via C. Olivetti 2, Agrate Brianza 20864 (ITALY)

Hereby, STMicroelectronics declares that the radio equipment type SPSGRF is in compliance with Directive 2014/53/EU.

The full text of the EU declaration of conformity is available at the following internet address:

<https://www.st.com/en/wireless-connectivity/spsgrf.html#documentation>

7 Module traceability and marking

The SPSGRF bottom-side label contains the following information:

- Model: "MODEL: SPSGRF-915" indicating the SPSGRF RF module family
- FCC USA Certification Identification number: "FCCID:S9NPSGRF". This code is valid only for 915 MHz frequency band
- IC Canada certification number: "IC: 8976C-SPSGRF". This code is used only for the Canadian market
- 2D laser data matrix

Figure 7. SPSGRF bottom side

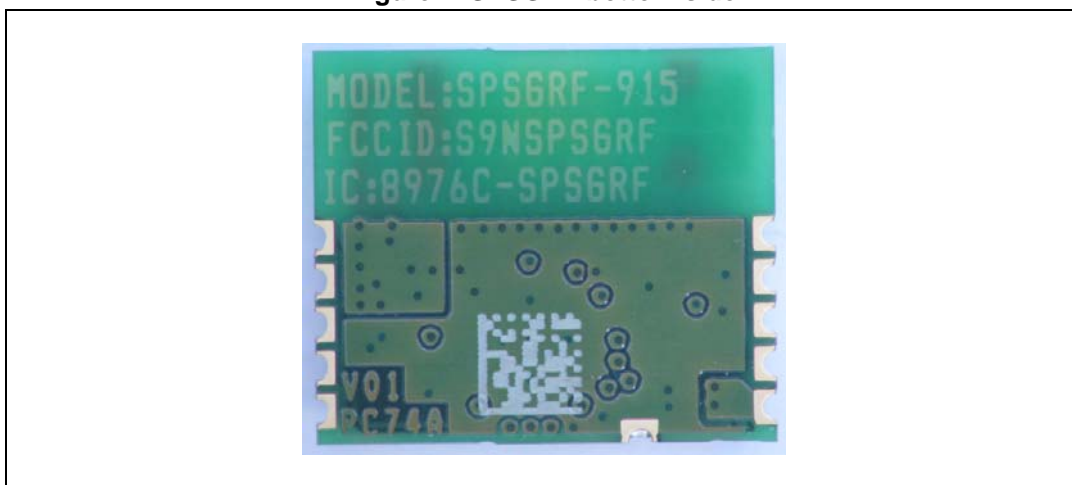

Each module is univocally identified by serial number stored in a 2D laser data matrix marked on the bottom of the module.

The figure below shows the standard bottom-side QR-code laser marking.

Figure 8. SPSGRF QR-code laser marking

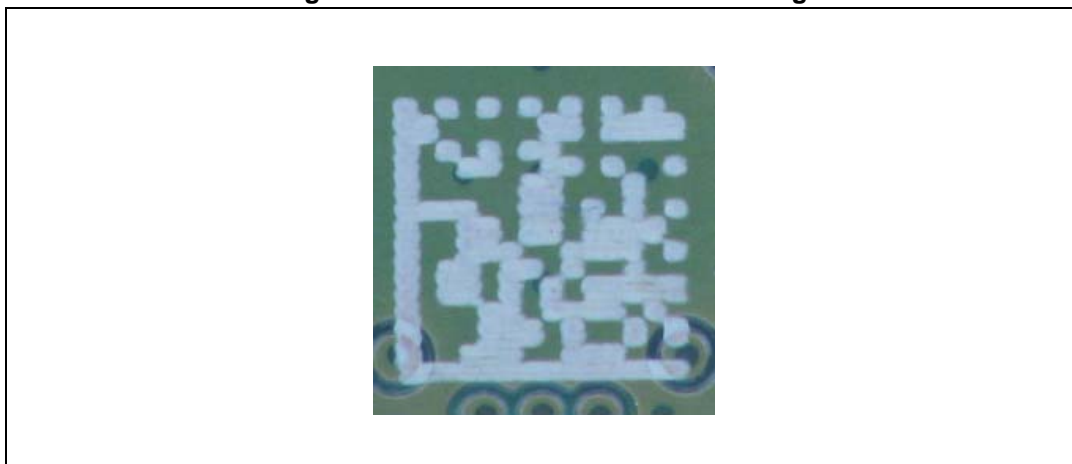

The serial number has the following format: WW YY K PP NNN

where:

- WW - Week
- YY - Year
- K - Product ID (refer to [Table 11](#) below)
- PP - internal ST use only
- NNN - internal ST use only

Table 11. Module Product ID

K	Product family identification
W	SPSGRF-868
X	SPSGRF-915

Each module bulk package is identified by a bulk ID.

The Bulk ID and module 2D data matrix are linked by a reciprocal traceability link.

The module 2D data matrix traces the lot number of any raw material used.

8 Ordering information

Table 12. Ordering information

Order code	Description	Packing	MOQ
SPSGRF-868	868 MHz SPIRIT1 transceiver module (Region 1, Europe)	JEDEC tray	2448 pcs
SPSGRF-915	915 MHz SPIRIT1 transceiver module (Region 2, The Americas)	JEDEC tray	2448 pcs

9 ECOPACK®

In order to meet environmental requirements, ST offers these devices in different grades of ECOPACK® packages, depending on their level of environmental compliance. ECOPACK® specifications, grade definitions and product status are available at: www.st.com. ECOPACK® is an ST trademark.

10 Revision history

Table 13. Document revision history

Date	Revision	Changes
31-Mar-2015	1	Initial release.
14-Apr-2015	2	Updated <i>Features</i> and <i>Description</i> in cover page.
22-May-2015	3	Updated <i>Description</i> in cover page.
29-Jun-2016	4	<ul style="list-style-type: none"> – Added marking and module identification details in <i>Section 7: Module traceability and marking</i>. – Updated <i>Figure 5: Recommended land pattern</i>
17-Oct-2016	5	Corrected typographical error in part number SPSGRF-915 in the <i>Features</i> and <i>Description</i> sections of the coverpage.
04-Oct-2017	6	Updated <i>Section 6.3: CE certification</i>
14-Oct-2021	7	Updated Section 3.4: Module RF compliance limits , Section 6.3: CE certification .

IMPORTANT NOTICE – PLEASE READ CAREFULLY

STMicroelectronics NV and its subsidiaries ("ST") reserve the right to make changes, corrections, enhancements, modifications, and improvements to ST products and/or to this document at any time without notice. Purchasers should obtain the latest relevant information on ST products before placing orders. ST products are sold pursuant to ST's terms and conditions of sale in place at the time of order acknowledgement.

Purchasers are solely responsible for the choice, selection, and use of ST products and ST assumes no liability for application assistance or the design of Purchasers' products.

No license, express or implied, to any intellectual property right is granted by ST herein.

Resale of ST products with provisions different from the information set forth herein shall void any warranty granted by ST for such product.

ST and the ST logo are trademarks of ST. For additional information about ST trademarks, please refer to www.st.com/trademarks. All other product or service names are the property of their respective owners.

Information in this document supersedes and replaces information previously supplied in any prior versions of this document.

© 2021 STMicroelectronics – All rights reserved

X-ON Electronics

Largest Supplier of Electrical and Electronic Components

Click to view similar products for [Sub-GHz Modules](#) category:

Click to view products by [STMicroelectronics](#) manufacturer:

Other Similar products are found below :

[HMC-C024](#) [nRF24L01P-MODULE-SMA](#) [CMD-KEY2-418-CRE](#) [V640-A90](#) [SM1231E868](#) [HMC-C582](#) [SM-MN-00-HF-RC](#) [HMC-C031](#)
[LoRa Node Kit\(US\)](#) [Sierra HL7588 4G KIT\(US\)](#) [WISE-4610-S672NA](#) [EC21AUFA-MINIPCIE](#) [EC21EUGA-MINIPCIE](#) [CS-EASYSWITCH-](#)
[25](#) [EC21JFB-MINIPCIE](#) [DL-RFM95-915M](#) [DL-RFM96-433M](#) [Ra-07H-V1.1](#) [Ra-07](#) [Ra-01SH](#) [Ra-01S-T](#) [Ra-01SH-T](#) [CMD-HHCP-418-MD](#)
[CMD-HHCP-433-MD](#) [CMD-HHLR-418-MD](#) [2095000000200](#) [XB9X-DMRS-031](#) [20911051101](#) [COM-13909](#) [HMC-C033](#) [COM-13910](#)
[WRL-14498](#) [SX1276RF1KAS](#) [HMC-C011](#) [HMC-C014](#) [HMC-C050](#) [HMC-C001](#) [HMC-C006](#) [HMC-C030](#) [HMC-C021](#) [HMC-C041](#) [HMC-](#)
[C042](#) [HMC-C048](#) [HMC-C051](#) [HMC-C071](#) [HMC-C072](#) [HMC-C088](#) [A2500R24C00GM](#) [702-W](#) [HUM-900-PRC](#)