

13.56 MHz short-range contactless memory chip with 512-bit EEPROM and anticollision functions

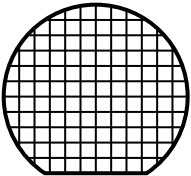

-Unsawn wafer
-Bumped and sawn wafer

Features

- ISO 14443-2 Type B air interface compliant
- ISO 14443-3 Type B frame format compliant
- 13.56 MHz carrier frequency
- 847 kHz subcarrier frequency
- 106 Kbit/second data transfer
- 8 bit Chip_ID based anticollision system
- 2 count-down binary counters with automated anti-tearing protection
- 64-bit Unique Identifier
- 512-bit EEPROM with write protect feature
- Read_block and Write_block (32 bits)
- Internal tuning capacitor: 68 pF
- 1 million erase/write cycles
- 40-year data retention
- Self-timed programming cycle
- 5 ms typical programming time

Product status link

[ST25TB512-AC](#)

1 Description

The **ST25TB512-AC** is a contactless memory, powered by an externally transmitted radio wave. It contains a 512-bit user EEPROM. The memory is organized as 16 blocks of 32 bits. The **ST25TB512-AC** is accessed via the 13.56 MHz carrier. Incoming data are demodulated and decoded from the received amplitude shift keying (ASK) modulation signal and outgoing data are generated by load variation using bit phase shift keying (BPSK) coding of a 847 kHz sub-carrier. The received ASK wave is 10% modulated. The data transfer rate between the **ST25TB512-AC** and the reader is 106 kbit/s in both reception and emission modes.

The **ST25TB512-AC** follows the ISO 14443 - 2 Type B recommendation for the radio-frequency power and signal interface.

Figure 1. Logic diagram

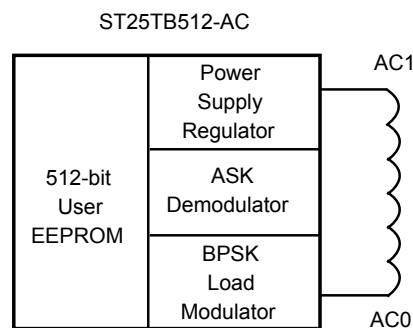

The **ST25TB512-AC** is specifically designed for short range applications that need re-usable products. The **ST25TB512-AC** includes an anticollision mechanism that allows it to detect and select tags present at the same time within range of the reader. The anticollision is based on a probabilistic scanning method using slot markers.

Table 1. Signal names

Signal names	Description
AC1	Antenna coil
AC0	Antenna coil

The **ST25TB512-AC** contact-less EEPROM can be randomly read and written in block mode (each block containing 32 bits). The instruction set includes the following nine commands:

- Read_block
- Write_block
- Initiate
- Pcall16
- Slot_marker
- Select
- Completion
- Reset_to_inventory
- Get_UID

The **ST25TB512-AC** memory is organized in three areas, as described in [Table 3](#). The first area is an resettable OTP (one time programmable) area in which bits can only be switched from 1 to 0. Using a special command, it is possible to erase all bits of this area to 1. The second area provides two 32-bit binary counters which can only be decremented. The last area is the EEPROM memory. It is accessible by block of 32 bits and includes an auto-erase cycle during each Write_block command.

Die floor plan and physical options related to the die assembly are described in [Figure 2](#).

Figure 2. Die floor plan and assembly options

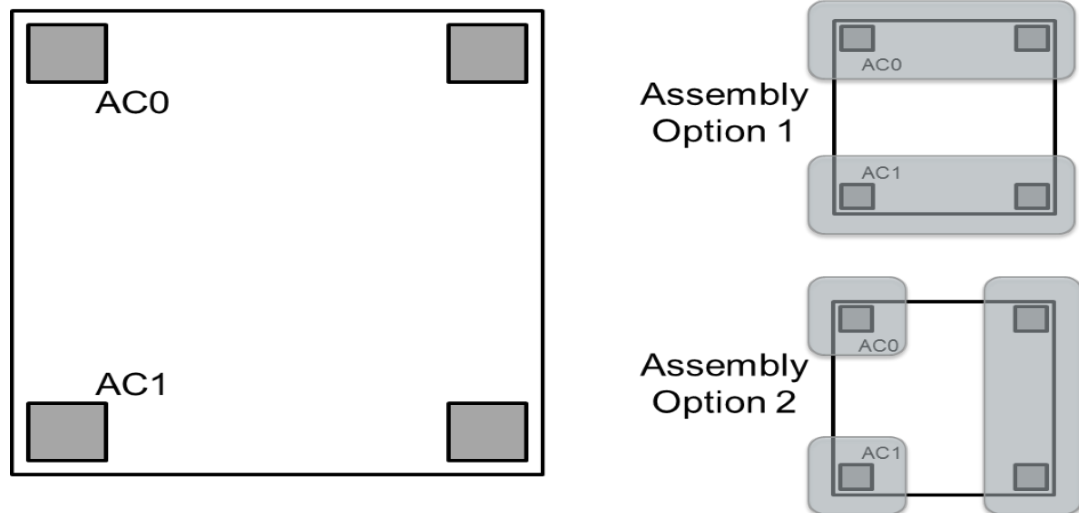

For the option 1 of the die assembly, the CTUN (referenced in [Section 10 RF electrical parameters](#)) can increase from 0.5 pF to 1 pF. The option 2 of the die assembly is showing a tripod which can be used for physical stability, having no impact on CTUN parameter.

2 Signal description

2.1 AC1, AC0

The pads for the Antenna Coil. AC1 and AC0 must be directly bonded to the antenna.

3 Data transfer

3.1 Input data transfer from reader to ST25TB512-AC (request frame)

The reader must generate a 13.56 MHz sinusoidal carrier frequency at its antenna, with enough energy to “remote-power” the memory. The energy received at the ST25TB512-AC’s antenna is transformed into a supply voltage by a regulator, and into data bits by the ASK demodulator. For the ST25TB512-AC to decode correctly the information it receives, the reader must 10% amplitude-modulate the 13.56 MHz wave before sending it to the ST25TB512-AC. This is represented in Figure 3. The data transfer rate is 106 Kbits/s.

In some figures of this datasheet the ST25TBxxx refers to ST25TB512-AC.

Figure 3. ST25TB512-AC 10% ASK modulation of the received wave

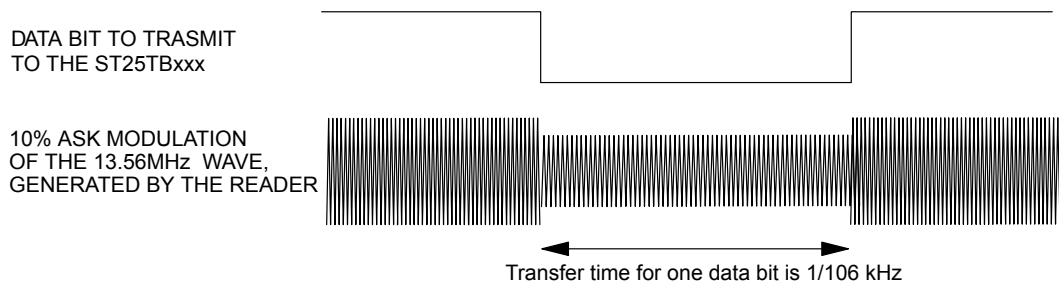

3.1.1 Character transmission format for request frame

The ST25TB512-AC transmits and receives data bytes as 10-bit characters, with the least significant bit (b_0) transmitted first, as shown in Figure 4. Each bit duration, an ETU (elementary time unit), is equal to 9.44 μ s (1/106 kHz).

These characters, framed by a start of frame (SOF) and an end of frame (EOF), are put together to form a command frame as shown in Figure 10. A frame includes an SOF, commands, addresses, data, a CRC and an EOF as defined in the ISO 14443-3 Type B Standard. If an error is detected during data transfer, the ST25TB512-AC does not execute the command, but it does not generate an error frame.

Figure 4. ST25TB512-AC request frame character format

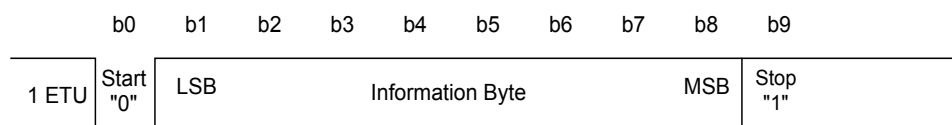

Table 2. Bit description

Bit	Description	Value
b_0	Start bit used to synchronize the transmission	$b_0 = 0$
b_1 to b_8	Information byte (command, address or data)	The information byte is sent with the least significant bit first
b_9	Stop bit used to indicate the end of a character	$b_9 = 1$

3.1.2 Request start of frame

The SOF described in [Figure 5](#) is composed of:

- one falling edge,
- followed by 10 ETUs at logic-0,
- followed by a single rising edge,
- followed by at least 2 ETUs (and at most 3) at logic-1.

Figure 5. Request start of frame

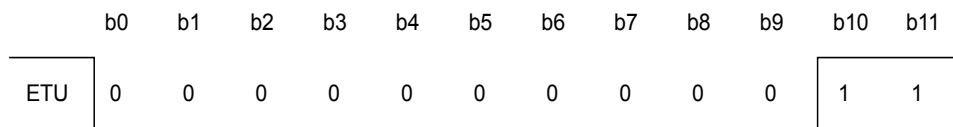

3.1.3 Request end of frame

The EOF shown in [Figure 6](#) is composed of:

- one falling edge,
- followed by 10 ETUs at logic-0,
- followed by a single rising edge.

Figure 6. Request end of frame

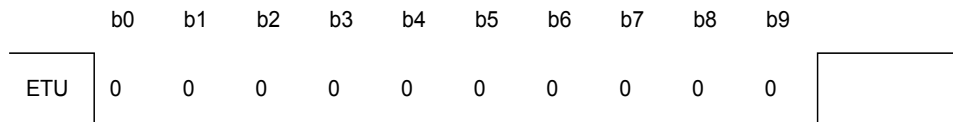

3.2 Output data transfer from ST25TB512-AC to reader (answer frame)

The data bits issued by the ST25TB512-AC use back-scattering. Back-scattering is obtained by modifying the ST25TB512-AC current consumption at the antenna (load modulation). The load modulation causes a variation at the reader antenna by inductive coupling. With appropriate detector circuitry, the reader is able to pick up information from the ST25TB512-AC. To improve load-modulation detection, data is transmitted using a BPSK encoded, 847 kHz subcarrier frequency f_s as shown in Figure 7, and as specified in the ISO 14443-2 Type B standard.

Figure 7. Wave transmitted using BPSK subcarrier modulation

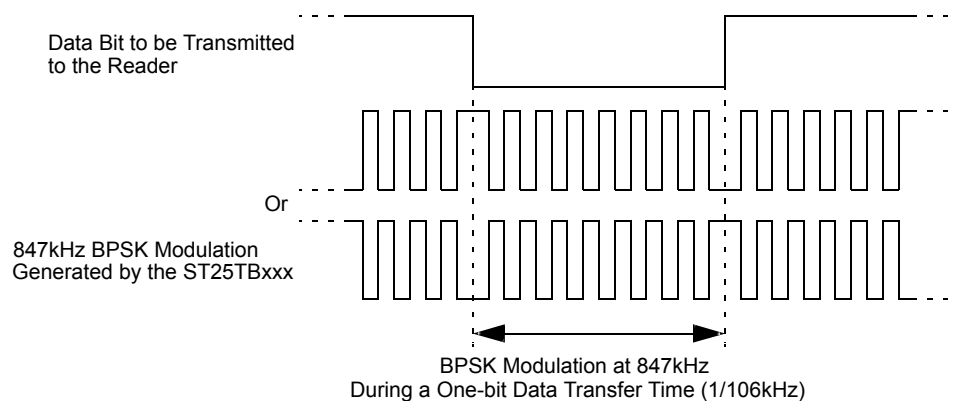

3.2.1 Character transmission format for answer frame

The character format is the same as for input data transfer (Figure 4). The transmitted frames are made up of an SOF, data, a CRC and an EOF (Figure 10). As with an input data transfer, if an error occurs, the reader does not issue an error code to the ST25TB512-AC, but it should be able to detect it and manage the situation. The data transfer rate is 106 Kbits/second.

3.2.2 Answer start of frame

The SOF described in Figure 8 is composed of:

- one falling edge,
- followed by 10 ETUs at logic-0,
- followed by 2 ETUs at logic-1.

Figure 8. Answer start of frame

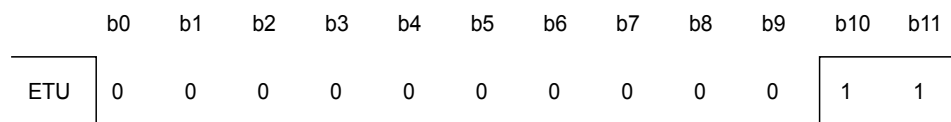

3.2.3 Answer end of frame

The EOF shown in Figure 9 is composed of:

- one falling edge,
- followed by 10 ETUs at logic-0,
- followed by 2 ETUs at logic-1.

Figure 9. Answer end of frame

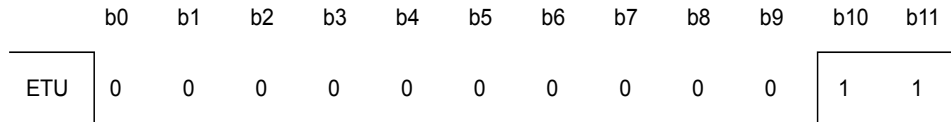

3.3 Transmission frame

Between the request data transfer and the answer data transfer, all ASK and BPSK modulations are suspended for a minimum time of $t_0 = 128/f_S$. This delay allows the reader to switch from Transmission to Reception mode. It is repeated after each frame. After t_0 , the 13.56 MHz carrier frequency is modulated by the ST25TB512-AC at 847 kHz for a period of $t_1 = 128/f_S$ to allow the reader to synchronize. After t_1 , the first phase transition generated by the ST25TB512-AC forms the start bit ('0') of the answer SOF. After the falling edge of the answer EOF, the reader waits a minimum time, t_2 , before sending a new request frame to the ST25TB512-AC.

Figure 10. Example of a complete transmission frame

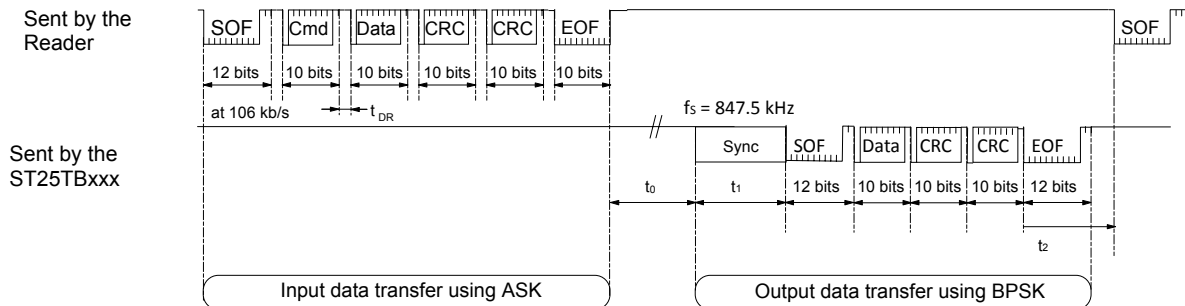

3.4 CRC

The 16-bit CRC used by the **ST25TB512-AC** is generated in compliance with the ISO14443 Type B recommendation. For further information, please see Appendix A [ISO-14443 Type B CRC calculation](#). The initial register contents are all 1s: FFFFh.

The two-byte CRC is present in every request and in every answer frame, before the EOF. The CRC is calculated on all the bytes between SOF (not included) and the CRC field.

Upon reception of a request from a reader, the **ST25TB512-AC** verifies that the CRC value is valid. If it is invalid, the **ST25TB512-AC** discards the frame and does not answer the reader.

Upon reception of an answer from the **ST25TB512-AC**, the reader should verify the validity of the CRC. In case of error, the actions to be taken are the reader designer's responsibility.

The CRC is transmitted with the least significant byte first and each byte is transmitted with the least significant bit first.

Figure 11. CRC transmission rules

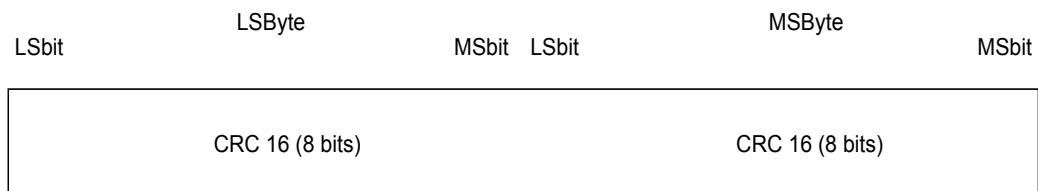

4 Memory mapping

The **ST25TB512-AC** is organized as 16 blocks of 32 bits as shown in . All blocks are accessible by the `Read_block` command. Depending on the write access, they can be updated by the `Write_block` command. A `Write_block` updates all the 32 bits of the block.

Table 3. ST25TB512-AC memory mapping

Block Address	32-bit block						Description
	MSB					LSB	
	b31	b24 b23	b16	b15	b8 b7	b0	
0	32-bit Boolean area						Resettable OTP bit
1	32-bit Boolean area						
2	32-bit Boolean area						
3	32-bit Boolean area						
4	32-bit Boolean area						
5	32 bits binary counter						Count down counter
6	32 bits binary counter						
7	User area						Lockable EEPROM
8	User area						
9	User area						
10	User area						
11	User area						
12	User area						
13	User area						
14	User area						
15	User area						
255	OTP_Lock_Reg			0	ST Reserved		System OTP bits
UID0	64 bits UID area						ROM
UID1							

4.1 EEPROM area

4.1.1 Block 0 - 4: resettable OTP area

This area contains five individual 32-bit Boolean words (see [Table 4. Resettable OTP area \(addresses 0 to 4\)](#) for a map of the area). A Write_block command will not erase the previous contents of the block as the write cycle is not preceded by an auto-erase cycle. This feature can be used to reset selected bits from 1 to 0. All bits previously at 0 remain unchanged. When the 32 bits of a block are all at 0, the block is empty, and cannot be updated any more. See [Figure 12. Write_block update in Standard mode \(binary format\)](#) and [Figure 13. Write_block update in Reload mode \(binary format\)](#) for examples of the result of the Write_block command in the resettable OTP area.

Table 4. Resettable OTP area (addresses 0 to 4)

Block Address	32-bit block					Description
	MSB b31	b24 b23		LSB b0		
0	32-bit Boolean area					Resettable OTP bit
1	32-bit Boolean area					
2	32-bit Boolean area					
3	32-bit Boolean area					
4	32-bit Boolean area					

Figure 12. Write_block update in Standard mode (binary format)

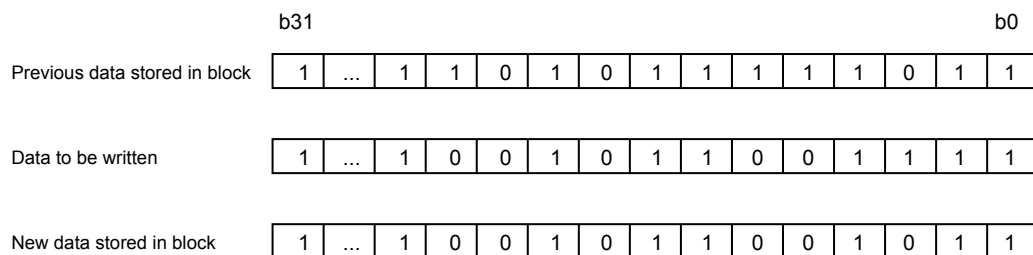

The five 32-bit blocks making up the resettable OTP area can be erased in one go by adding an auto-erase cycle to the Write_block command. An auto-erase cycle is added each time one reload mode is activated. The reload mode is implemented through a specific update of the 32-bit binary counter located at block address 6 (see [Section 4.2 32-bit binary counters](#) for details).

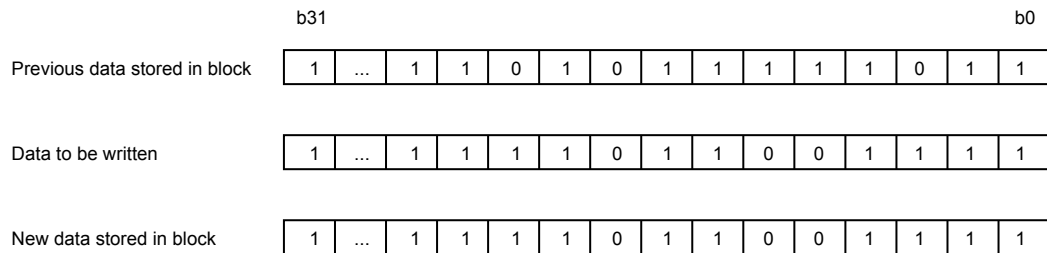
Figure 13. Write_block update in Reload mode (binary format)

4.1.2 Block 7 - 15

The 9 blocks between addresses 7 and 15 are EEPROM blocks of 32 bits each (36 bytes in total). (See not found for a map of the area.) These blocks can be accessed using the Read_block and Write_block commands. The Write_block command for the EEPROM area always includes an auto-erase cycle prior to the write cycle.

Blocks 7 to 15 can be write-protected. Write access is controlled by the 9 bits of the OTP_Lock_Reg located at block address 255 (see Section 4.3.1 OTP_Lock_Reg for details). Once protected, these blocks (7 to 15) cannot be unprotected.

Table 5. EEPROM area (addresses 7 to 15)

Block Address	32-bit block				Description	
	MSB			LSB		
	b31	b24 b23	b16 b15	b8 b7	b0	
7						Lockable EEPROM
8						
9						
10						
11						
12						
13						
14						
15						

4.2 32-bit binary counters

The two 32-bit binary counters are located at block addresses 5 and 6. The **ST25TB512-AC** uses dedicated logic that only allows the update of a counter if the new value is lower than the previous one. This feature allows the application to count down by steps of 1 or more. The initial value in Counter 5 is FFFF FFFEh and is FFFF FFFFh in Counter 6. When the reached value is 0000 0000h, the counter is empty and cannot be reloaded. For each counter 5 and 6, the update is done by issuing the Write_block command. The Write_block command writes the new 32-bit value to the counter block address. [Table 6](#) shows examples of how the counters operate.

The counter programming cycles are protected by automated antitearing logic. This function allows the counter value to be protected in case of power down within the programming cycle. In case of power down, the counter value is not updated and the previous value continues to be stored.

Blocks 5 and 6 can be write-protected using the OTP_Lock_Reg bits (block 255). Once a block has been protected, its contents cannot be modified. A protected counter block behaves like a ROM block.

Table 6. Binary counter (addresses 5 to 6)

Block Address	MSB	32-bit block			LSB	Description
	b31	b24 b23	b16 b15	b8 b7	b0	
5	32-bit Boolean area					Count down counter
6	32-bit Boolean area					

Figure 14. Countdown example (binary format)

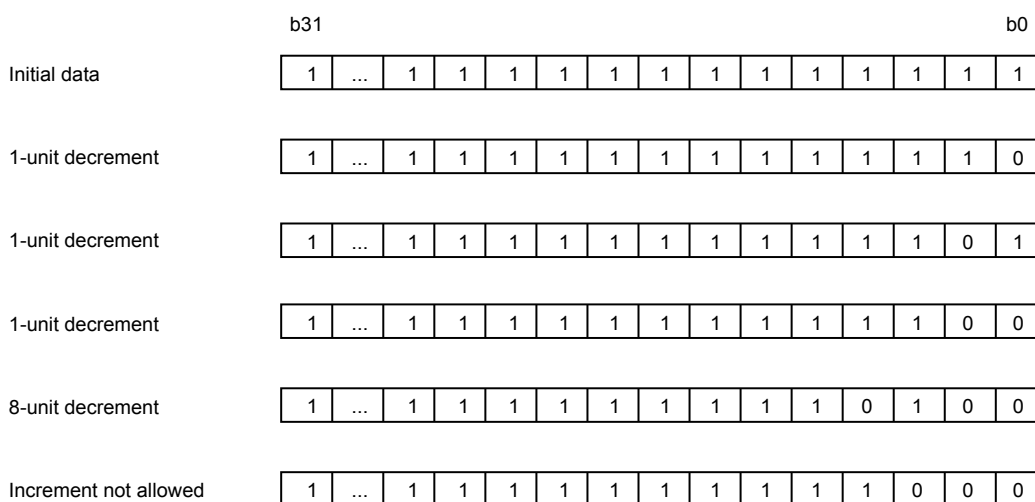

The counter with block address 6 controls the reload mode used to reset the resettable OTP area (addresses 0 to 4). Bits b_{31} to b_{21} act as an 11-bit Reload counter; whenever one of these 11 bits is updated, the **ST25TB512-AC** detects the change and adds an Erase cycle to the Write_block command for locations 0 to 4 (see the [Section 4.1.1 Block 0 - 4: resettable OTP area](#)).

The Erase cycle remains active until a Power-off or a Select command is issued.

The **ST25TB512-AC**'s resettable OTP area can be reloaded up to 2 047 times (2¹¹-1).

4.3 System area

This area is used to modify the settings of the [ST25TB512-AC](#). It contains 2 registers: OTP_Lock_Reg and ST Reserved. See [Table 7](#) for a map of this area.

A Write_block command in this area will not erase the previous contents. Selected bits can thus be set from 1 to 0. All bits previously at 0 remain unchanged. Once all the 32 bits of a block are at 0, the block is empty and cannot be updated any more.

Table 7. System area

Block Address	MSB			32-bit block					LSB	Description
	b31	b24	b23	b16	b15	b14	b7	b0		
255	OTP_Lock_Reg			0		ST reserved			OTP	

4.3.1 OTP_Lock_Reg

The 16 bits, b_{31} to b_{16} , of the System area (block address 255) are used as OTP_Lock_Reg bits in the [ST25TB512-AC](#). They control the write access to the 16 EEPROM blocks with addresses 0 to 15 as follows:

- When b_{16} is at 0, block 0 is write-protected
- When b_{17} is at 0, block 1 is write-protected
- When b_{18} is at 0, block 2 is write-protected
- When b_{19} is at 0, block 3 is write-protected
- When b_{20} is at 0, block 4 is write-protected
- When b_{21} is at 0, block 5 is write-protected
- When b_{22} is at 0, block 6 is write-protected
- When b_{23} is at 0, block 7 is write-protected.
- When b_{24} is at 0, block 8 is write-protected
- When b_{25} is at 0, block 9 is write-protected
- When b_{26} is at 0, block 10 is write-protected
- When b_{27} is at 0, block 11 is write-protected
- When b_{29} is at 0, block 12 is write-protected
- When b_{29} is at 0, block 13 is write-protected
- When b_{30} is at 0, block 14 is write-protected
- When b_{31} is at 0, block 15 is write-protected.

The OTP_Lock_Reg bits cannot be erased. Once write-protected, EEPROM blocks behave like ROM blocks and cannot be unprotected.

After any modification of the OTP_Lock_Reg bits, it is necessary to send a Select command with a valid Chip_ID to the [ST25TB512-AC](#) in order to load the block write protection into the logic.

5 ST25TB512-AC operation

All commands, data and CRC are transmitted to the **ST25TB512-AC** as 10-bit characters using ASK modulation. The start bit of the 10 bits, b_0 , is sent first. The command frame received by the **ST25TB512-AC** at the antenna is demodulated by the 10% ASK demodulator, and decoded by the internal logic. Prior to any operation, the **ST25TB512-AC** must have been selected by a Select command. Each frame transmitted to the **ST25TB512-AC** must start with a start of frame, followed by one or more data characters, two CRC bytes and the final end of frame. When an invalid frame is decoded by the **ST25TB512-AC** (wrong command or CRC error), the memory does not return any error code.

When a valid frame is received, the **ST25TB512-AC** may have to return data to the reader. In this case, data is returned using BPSK encoding, in the form of 10-bit characters framed by an SOF and an EOF. The transfer is ended by the **ST25TB512-AC** sending the 2 CRC bytes and the EOF.

6 ST25TB512-AC states

The ST25TB512-AC can be switched into different states. Depending on the current state of the ST25TB512-AC, its logic will only answer to specific commands. These states are mainly used during the anticollision sequence, to identify and to access the ST25TB512-AC in a very short time. The ST25TB512-AC provides 6 different states, as described in the following paragraphs and in Figure 15.

6.1 Power-off state

The ST25TB512-AC is in Power-off state when the electromagnetic field around the tag is not strong enough. In this state, the ST25TB512-AC does not respond to any command.

6.2 Ready state

When the electromagnetic field is strong enough, the ST25TB512-AC enters the Ready state. After Power-up, the Chip_ID is initialized with a random value. The whole logic is reset and remains in this state until an Initiate() command is issued. Any other command will be ignored by the ST25TB512-AC.

6.3 Inventory state

The ST25TB512-AC switches from the Ready to the Inventory state after an Initiate() command has been issued. In Inventory state, the ST25TB512-AC will respond to any anticollision commands: Initiate(), Pcall16() and Slot_marker(), and then remain in the Inventory state. It will switch to the Selected state after a Select(Chip_ID) command is issued, if the Chip_ID in the command matches its own. If not, it will remain in Inventory state.

6.4 Selected state

In Selected state, the ST25TB512-AC is active and responds to all Read_block(), Write_block() and Get_UID() commands. When an ST25TB512-AC has entered the Selected state, it no longer responds to anticollision commands. So that the reader can access another tag, the ST25TB512-AC can be switched to the Deselected state by sending a Select(Chip_ID) with a Chip_ID that does not match its own, or it can be placed in Deactivated state by issuing a Completion() command. Only one ST25TB512-AC can be in Selected state at a time.

6.5 Deselected state

Once the ST25TB512-AC is in Deselected state, only a Select(Chip_ID) command with a Chip_ID matching its own can switch it back to Selected state. All other commands are ignored.

6.6 Deactivated state

When in this state, the ST25TB512-AC can only be turned off. All commands are ignored.

Figure 15. State transition diagram

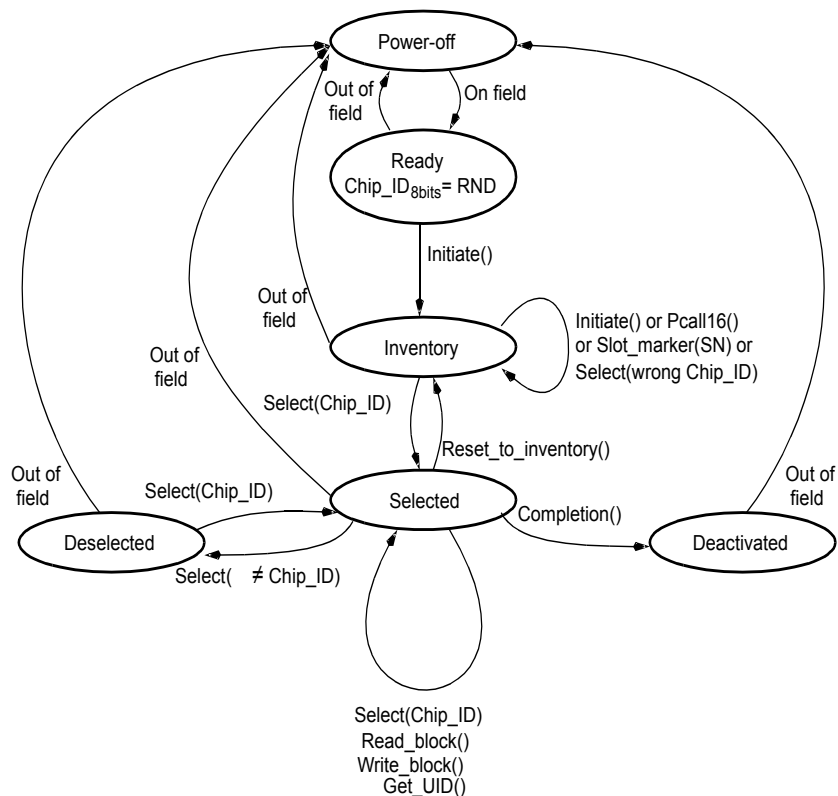

7 Anticollision

The **ST25TB512-AC** provides an anticollision mechanism that searches for the `Chip_ID` of each device that is present in the reader field range. When known, the `Chip_ID` is used to select an **ST25TB512-AC** individually, and access its memory. The anticollision sequence is managed by the reader through a set of commands described in [Section 8 ST25TB512-AC commands](#):

- `Initiate()`
- `Pcall16()`
- `Slot_marker()`.

The reader is the master of the communication with one or more **ST25TB512-AC** device(s). It initiates the tag communication activity by issuing an `Initiate()`, `Pcall16()` or `Slot_marker()` command to prompt the **ST25TB512-AC** to answer. During the anticollision sequence, it might happen that two or more **ST25TB512-AC** devices respond simultaneously, so causing a collision. The command set allows the reader to handle the sequence, to separate **ST25TB512-AC** transmissions into different time slots. Once the anticollision sequence has completed, **ST25TB512-AC** communication is fully under the control of the reader, allowing only one **ST25TB512-AC** to transmit at a time.

The Anticollision scheme is based on the definition of time slots during which the **ST25TB512-AC** devices are invited to answer with minimum identification data: the `Chip_ID`. The number of slots is fixed at 16 for the `Pcall16()` command. For the `Initiate()` command, there is no slot and the **ST25TB512-AC** answers after the command is issued. **ST25TB512-AC** devices are allowed to answer only once during the anticollision sequence. Consequently, even if there are several **ST25TB512-AC** devices present in the reader field, there will probably be a slot in which only one **ST25TB512-AC** answers, allowing the reader to capture its `Chip_ID`. Using the `Chip_ID`, the reader can then establish a communication channel with the identified **ST25TB512-AC**. The purpose of the anticollision sequence is to allow the reader to select one **ST25TB512-AC** at a time.

The **ST25TB512-AC** is given an 8-bit `Chip_ID` value used by the reader to select only one among up to 256 tags present within its field range. The `Chip_ID` is initialized with a random value during the Ready state, or after an `Initiate()` command in the Inventory state.

The four least significant bits (b_0 to b_3) of the `Chip_ID` are also known as the `Chip_slot_number`. This 4-bit value is used by the `Pcall16()` and `Slot_marker()` commands during the anticollision sequence in the Inventory state.

Figure 16. ST25TB512-AC Chip_ID description

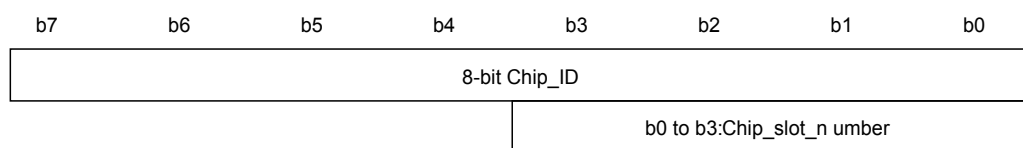

Each time the **ST25TB512-AC** receives a `Pcall16()` command, the `Chip_slot_number` is given a new 4-bit random value. If the new value is 0000_b , the **ST25TB512-AC** returns its whole 8-bit `Chip_ID` in its answer to the `Pcall16()` command. The `Pcall16()` command is also used to define the slot number 0 of the anticollision sequence. When the **ST25TB512-AC** receives the `Slot_marker(SN)` command, it compares its `Chip_slot_number` with the `Slot_number` parameter (SN). If they match, the **ST25TB512-AC** returns its `Chip_ID` as a response to the command. If they do not, the **ST25TB512-AC** does not answer. The `Slot_marker(SN)` command is used to define all the anticollision slot numbers from 1 to 15.

Figure 17. Description of a possible anticollision sequence

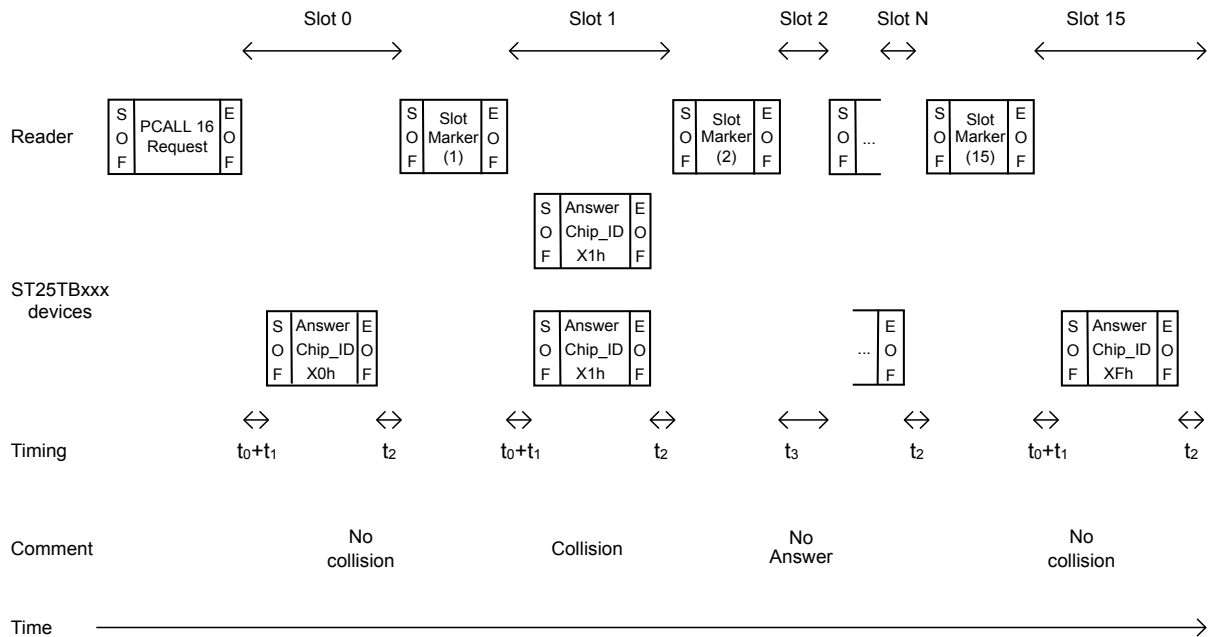

- The value X in the answer Chip_ID means a random hexadecimal character from 0 to F.

7.1 Description of an anticollision sequence

The anticollision sequence is initiated by the Initiate() command which triggers all the **ST25TB512-AC** devices that are present in the reader field range, and that are in Inventory state. Only **ST25TB512-AC** devices in Inventory state will respond to the Pcall16() and Slot_marker(SN) anticollision commands.

A new **ST25TB512-AC** introduced in the field range during the anticollision sequence will not be taken into account as it will not respond to the Pcall16() or Slot_marker(SN) command (Ready state). To be considered during the anticollision sequence, it must have received the Initiate() command and entered the Inventory state.

[Table 8](#) shows the elements of a standard anticollision sequence. (See [Table 9](#) for an example.)

Table 8. Standard anticollision sequence

Step 1	Init:	Send Initiate(). <ul style="list-style-type: none"> If no answer is detected, go to step1. If only 1 answer is detected, select and access the ST25TB512-AC. After accessing the ST25TB512-AC, deselect the tag and go to step1. If a collision (many answers) is detected, go to step2.
Step 2	Slot 0	Send Pcall16(). <ul style="list-style-type: none"> If no answer or collision is detected, go to step3. If 1 answer is detected, store the Chip_ID, Send Select() and go to step3.
Step 3	Slot 1	Send Slot_marker(1). <ul style="list-style-type: none"> If no answer or collision is detected, go to step4. If 1 answer is detected, store the Chip_ID, Send Select() and go to step4.
Step 4	Slot 2	Send Slot_marker(2). <ul style="list-style-type: none"> If no answer or collision is detected, go to step5. If 1 answer is detected, store the Chip_ID, Send Select() and go to step5.
Step N	Slot N	Send Slot_marker(3 up to 14) ... <ul style="list-style-type: none"> If no answer or collision is detected, go to stepN+1. If 1 answer is detected, store the Chip_ID, Send Select() and go to stepN+1.
Step 17	Slot 15	Send Slot_marker(15). <ul style="list-style-type: none"> If no answer or collision is detected, go to step18. If 1 answer is detected, store the Chip_ID, Send Select() and go to step18.
Step 18	-	All the slots have been generated and the Chip_ID values should be stored into the reader memory. Issue the Select(Chip_ID) command and access each identified ST25TB512-AC one by one. After accessing each ST25TB512-AC , switch them into Deselected or Deactivated state, depending on the application needs. <ul style="list-style-type: none"> If collisions were detected between Step2 and Step17, go to Step2. If no collision was detected between Step2 and Step17, go to Step1.

After each Slot_marker() command, there may be no answer, one or several answers from the **ST25TB512-AC** devices. The reader must handle all the cases and store all the Chip_IDs, correctly decoded. At the end of the anticollision sequence, after Slot_marker(15), the reader can start working with one **ST25TB512-AC** by issuing a Select() command containing the desired Chip_ID. If a collision is detected, the reader has to generate a new sequence in order to identify all unidentified **ST25TB512-AC** devices in the field. The anticollision sequence can stop when all **ST25TB512-AC** devices have been identified.

Table 9 gives an example of anticollision sequence, the cells containing (*) highlight the fact that the related tags are not yet identified. When the tag is identified, in the table the (*) changes to bold character.

Table 9. Example of an anticollision sequence

Command	Tag1	Tag2	Tag3	Tag4	Tag5	Tag6	Tag7	Tag8	Comment
	Chip_ID	Chip_ID	Chip_ID	Chip_ID	Chip_ID	Chip_ID	Chip_ID	Chip_ID	
READY state	28h(*)	75h(*)	40h(*)	01h(*)	02h(*)	FEh(*)	A9h(*)	7Ch(*)	Each tag gets a random Chip_ID
INITIATE()	40h(*)	13h(*)	3Fh(*)	4Ah(*)	50h(*)	48h(*)	52h(*)	7Ch(*)	Each tag get a new random Chip_ID. All tags answer: collisions
PCALL16()	45h(*)	12h(*)	30h(*)	43h(*)	55h(*)	43h(*)	53h(*)	73h(*)	All CHIP_SLOT_NUMBERS get a new random value
SELECT(30h)	(*)	(*)	(*)30h	(*)	(*)	(*)	(*)	(*)	Slot0: only one answer
SLOT_MARKER(1)	(*)	(*)	30h	(*)	(*)	(*)-	(*)-	(*)	Slot1: no answer
SLOT_MARKER(2)	(*)	12h(*)	-	(*)	(*)	(*)	(*)	(*)	Slot2: only one answer

Command	Tag1	Tag2	Tag3	Tag4	Tag5	Tag6	Tag7	Tag8	Comment
	Chip_ID	Chip_ID	Chip_ID	Chip_ID	Chip_ID	Chip_ID	Chip_ID	Chip_ID	
SELECT(12h)	(*)	12h	-	(*)	(*)	(*)	(*)	(*)	Tag2 is identified
SLOT_MARKER(3)	(*)	-	-	43h(*)	(*)	43h(*)	53h(*)	73h(*)	Slot3: collision
SLOT_MARKER(4)	(*)	-	-	(*)	(*)	(*)	(*)	(*)	Slot4: no answer
SLOT_MARKER(5)	45h(*)	-	-	(*)	55h(*)	(*)	(*)	(*)	Slot5: collision
SLOT_MARKER(6)	(*)	-	-	(*)	(*)	(*)	(*)	(*)	Slot6: no answer
SLOT_MARKER(N)	(*)	-	-	(*)	(*)	(*)	(*)	(*)	SlotN: no answer
SLOT_MARKER(F)	(*)	-	-	(*)	(*)	(*)	(*)	(*)	SlotF: no answer
PCALL16()	40h(*)	-	-	41h(*)	53h(*)	42h(*)	50h(*)	74h(*)	All CHIP_SLOT_NUMBERS get a new random value
	40h(*)	-	-	(*)	(*)	(*)	50h(*)	(*)	Slot0: collision
SLOT_MARKER(1)	(*)	-	-	41h(*)	(*)	(*)	(*)	(*)	Slot1: only one answer
SELECT(41h)	(*)	-	-	41h	(*)	(*)	(*)	(*)	Tag4 is identified
SLOT_MARKER(2)	(*)	-	-	-	(*)	42h(*)	(*)	(*)	Slot2: only one answer
SELECT(42h)	(*)	-	-	-	(*)	42h	(*)	(*)	Tag6 is identified
SLOT_MARKER(3)	(*)	-	-	-	53h(*)	-	(*)	(*)	Slot3: only one answer
SELECT(53h)	(*)	-	-	-	53h	-	(*)	(*)	Tag5 is identified
SLOT_MARKER(4)	(*)	-	-	-	-	-	(*)	74h(*)	Slot4: only one answer
SELECT(74h)	(*)	-	-	-	-	-	(*)	74h	Tag8 is identified
SLOT_MARKER(N)	(*)	-	-	-	-	-	(*)	-	SlotN: no answer
PCALL16()	41h(*)	-	-	-	-	-	50h(*)	-	All CHIP_SLOT_NUMBERS get a new random value
	(*)	-	-	-	-	-	50h(*)	-	Slot0: only one answer
SELECT(50h)	(*)	-	-	-	-	-	50h	-	Tag7 is identified
SLOT_MARKER(1)	41h(*)	-	-	-	-	-	-	-	Slot1: only one answer but already found for tag4
SLOT_MARKER(N)	(*)	-	-	-	-	-	-	-	SlotN: only one answer
PCALL16()	43h(*)	-	-	-	-	-	-	-	All CHIP_SLOT_NUMBERS get a new random value
	(*)	-	-	-	-	-	-	-	Slot0: only one answer
SLOT_MARKER(3)	43h(*)	-	-	-	-	-	-	-	Slot3: only one answer
SELECT(43h)	43h	-	-	-	-	-	-	-	Tag1 is identified
-	(*)	-	-	-	-	-	-	-	All tags are identified

8 ST25TB512-AC commands

See the paragraphs below for a detailed description of the commands available on the [ST25TB512-AC](#). The commands and their hexadecimal codes are summarized in [Table 10](#). A brief is given in Appendix B [ST25TB512-AC command brief](#).

Table 10. Command code

Hexadecimal code	Command
06h-00h	Initiate()
06h-04h	Pcall16()
x6h	Slot_marker (SN)
08h	Read_block(Addr)
09h	Write_block(Addr, Data)
0Bh	Get_UID()
0Ch	Reset_to_inventory
0Eh	Select(Chip_ID)
0Fh	Completion()

8.1 Initiate() command

Command code = 06h - 00h

Initiate() is used to initiate the anticollision sequence of the **ST25TB512-AC**. On receiving the Initiate() command, all **ST25TB512-AC** devices in Ready state switch to Inventory state, set a new 8-bit Chip_ID random value, and return their Chip_ID value. This command is useful when only one **ST25TB512-AC** in Ready state is present in the reader field range. It speeds up the Chip_ID search process. The Chip_slot_number is not used during Initiate() command access.

Figure 18. Initiate request format

SOF	Initiate		CRC _L	CRC _H	EOF
	06h	00h	8 bits	8 bits	

Request parameter:

- No parameter

Figure 19. Initiate response format

SOF	Chip_ID	CRC _L	CRC _H	EOF
	8 bits	8 bits	8 bits	

Response parameter:

- Chip_ID of the **ST25TB512-AC**

Figure 20. Initiate frame exchange between reader and ST25TB512-AC

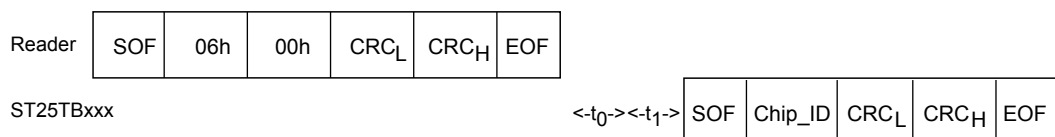

8.2 Pcall16() command

Command code = 06h - 04h

The **ST25TB512-AC** must be in Inventory state to interpret the Pcall16() command.

On receiving the Pcall16() command, the **ST25TB512-AC** first generates a new random Chip_slot_number value (in the 4 least significant bits of the Chip_ID). Chip_slot_number can take on a value between 0 and 15 (1111_b).

The value is retained until a new Pcall16() or Initiate() command is issued, or until the **ST25TB512-AC** is powered off. The new Chip_slot_number value is then compared with the value 0000_b. If they match, the **ST25TB512-AC** returns its Chip_ID value. If not, the **ST25TB512-AC** does not send any response.

The Pcall16() command, used together with the Slot_marker() command, allows the reader to search for all the Chip_IDs when there are more than one **ST25TB512-AC** device in Inventory state present in the reader field range.

Figure 21. Pcall16 request format

SOF	PCALL16		CRC _L	CRC _H	EOF
	06h	04h	8 bits	8 bits	

Request parameter:

- No parameter

Figure 22. Pcall16 response format

SOF	Chip_ID	CRC _L	CRC _H	EOF
	8 bits	8 bits	8 bits	

Response parameter:

- Chip_ID of the **ST25TB512-AC**

Figure 23. Pcall16 frame exchange between reader and ST25TB512-AC

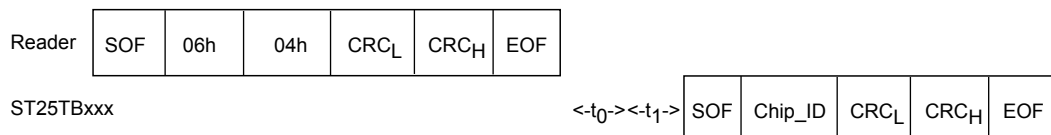

8.3 Slot_marker(SN) command

Command code = x6h

The **ST25TB512-AC** must be in Inventory state to interpret the Slot_marker(SN) command.

The Slot_marker byte code is divided into two parts:

- b₃ to b₀: 4-bit command code
- with fixed value 6.
- b₇ to b₄: 4 bits known as the Slot_number (SN). They assume a value between 1 and 15. The value 0 is reserved by the Pcall16() command.

On receiving the Slot_marker() command, the **ST25TB512-AC** compares its Chip_slot_number value with the Slot_number value given in the command code. If they match, the **ST25TB512-AC** returns its Chip_ID value. If not, the **ST25TB512-AC** does not send any response.

The Slot_marker() command, used together with the Pcall16() command, allows the reader to search for all the Chip_IDs when there are more than one **ST25TB512-AC** device in Inventory state present in the reader field range.

Figure 24. Slot_marker request format

SOF	Slot_marker	CRC _L	CRC _H	EOF
	X6h	8 bits	8 bits	

Request parameter:

- x: Slot number

Figure 25. Slot_marker response format

SOF	Chip_ID	CRC _L	CRC _H	EOF
	8 bits	8 bits	8 bits	

Response parameters:

- Chip_ID of the **ST25TB512-AC**

Figure 26. Slot_marker frame exchange between reader and ST25TB512-AC

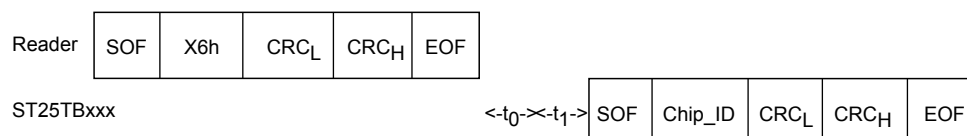

8.4 Select(Chip_ID) command

Command code = 0Eh

The Select() command allows the **ST25TB512-AC** to enter the Selected state. Until this command is issued, the **ST25TB512-AC** will not accept any other command, except for Initiate(), Pcall16() and Slot_marker(). The Select() command returns the 8 bits of the Chip_ID value. An **ST25TB512-AC** in Selected state, that receives a Select() command with a Chip_ID that does not match its own is automatically switched to Deselected state.

Figure 27. Select request format

SOF	Select	Chip_ID	CRC _L	CRC _H	EOF
	0Eh	8 bits	8 bits	8 bits	

Request parameter:

- 8-bit Chip_ID stored during the anticollision sequence

Figure 28. Select response format

SOF	Chip_ID	CRC _L	CRC _H	EOF
	8 bits	8 bits	8 bits	

Response parameters:

- Chip_ID of the selected tag. Must be equal to the transmitted Chip_ID

Figure 29. Select frame exchange between reader and ST25TB512-AC

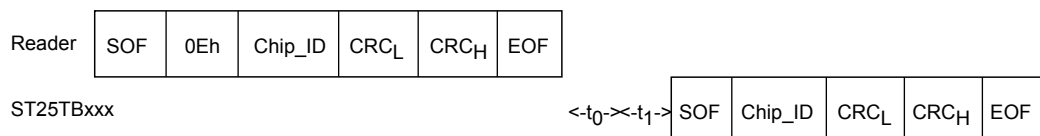

8.5 Completion() command

Command code = 0Fh

On receiving the Completion() command, an ST25TB512-AC in Selected state switches to Deactivated state and stops decoding any new commands. The ST25TB512-AC is then locked in this state until a complete reset (tag out of the field range). A new ST25TB512-AC can thus be accessed through a Select() command without having to remove the previous one from the field. The Completion() command does not generate a response.

All ST25TB512-AC devices not in Selected state ignore the Completion() command.

Figure 30. Completion request format

SOF	Completion	CRC _L	CRC _H	EOF
	0Fh	8 bits	8 bits	

Request parameters:

- No parameter

Figure 31. Completion response format

No Response

Figure 32. Completion frame exchange between reader and ST25TB512-AC

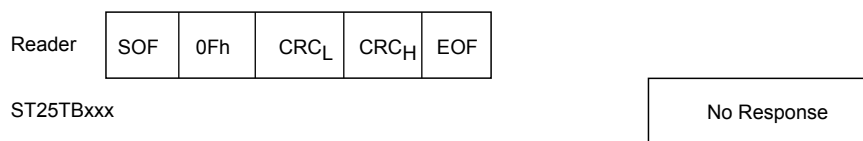

8.6 Reset_to_inventory() command

Command code = 0Ch

On receiving the Reset_to_inventory() command, all ST25TB512-AC devices in Selected state revert to Inventory state. The concerned ST25TB512-AC devices are thus resubmitted to the anticollision sequence. This command is useful when two ST25TB512-AC devices with the same 8-bit Chip_ID happen to be in Selected state at the same time. Forcing them to go through the anticollision sequence again allows the reader to generate new Pcall16() commands and so, to set new random Chip_IDs.

The Reset_to_inventory() command does not generate a response.

All ST25TB512-AC devices that are not in Selected state ignore the Reset_to_inventory() command.

Figure 33. Reset_to_inventory request format

SOF	RESET_TO_INVENTORY	CRC _L	CRC _H	EOF
	0Ch	8 bits	8 bits	

Request parameter:

- No parameter

Figure 34. Reset_to_inventory response format

No Response

Figure 35. Reset_to_inventory frame exchange between reader and ST25TB512-AC

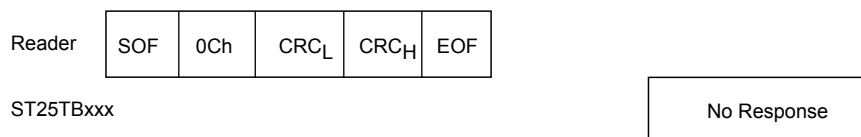

8.7 Read_block(Addr) command

Command code = 08h

On receiving the Read_block command, the **ST25TB512-AC** reads the desired block and returns the 4 data bytes contained in the block. Data bytes are transmitted with the least significant byte first and each byte is transmitted with the least significant bit first.

The address byte gives access to the 16 blocks of the **ST25TB512-AC** (addresses 0 to 15). Read_block commands issued with a block address above 15 will not be interpreted and the **ST25TB512-AC** will not return any response, except for the System area located at address 255.

The **ST25TB512-AC** must have received a Select() command and be switched to Selected state before any Read_block() command can be accepted. All Read_block() commands sent to the **ST25TB512-AC** before a Select() command is issued are ignored.

Figure 36. Read_block request format

SOF	Read_block	Address	CRC _L	CRC _H	EOF
	08h	8 bits	8 bits	8 bits	

Request parameter:

- Address: block addresses from 0 to 15, or 255

Figure 37. Read_block response format

SOF	Data 1	Data 2	Data 3	Data 4	CRC _L	CRC _H	EOF
	8 bits	8 bits	8 bits	8 bits	8 bits	8 bits	

Response parameters:

- Data 1: Less significant data byte
- Data 2: Data byte
- Data 3: Data byte
- Data 4: Most significant data byte

Figure 38. Read_block frame exchange between reader and ST25TB512-AC

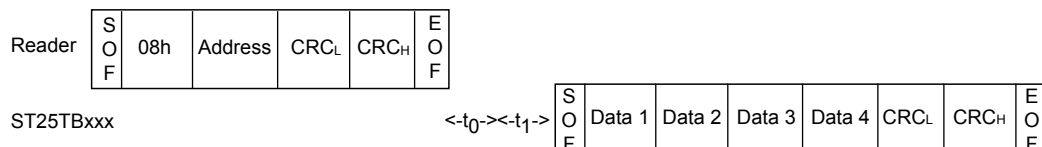

8.8 Write_block (Addr, Data) command

Command code = 09h

On receiving the Write_block command, the ST25TB512-AC writes the 4 bytes contained in the command to the addressed block, provided that the block is available and not write-protected. Data bytes are transmitted with the least significant byte first, and each byte is transmitted with the least significant bit first.

The address byte gives access to the 16 blocks of the ST25TB512-AC (addresses 0 to 15). Write_block commands issued with a block address above 15 will not be interpreted and the ST25TB512-AC will not return any response, except for the System area located at address 255.

The result of the Write_block command is submitted to the addressed block. See the following tables for a complete description of the Write_block command:

- [Table 4. Resettable OTP area \(addresses 0 to 4\)](#)
- [Table 6. Binary counter \(addresses 5 to 6\)](#)
- [Table 5. EEPROM area \(addresses 7 to 15\)](#)

The Write_block command does not give rise to a response from the ST25TB512-AC. The reader must check after the programming time, t_W , that the data was correctly programmed. The ST25TB512-AC must have received a Select() command and be switched to Selected state before any Write_block command can be accepted. All Write_block commands sent to the ST25TB512-AC before a Select() command is issued, are ignored.

Figure 39. Write_block request format

SOF	Write_block	Address	Data 1	Data 2	Data 3	Data 4	CRC _L	CRC _H	EOF
	09h	8 bits	8 bits	8 bits	8 bits	8 bits	8 bits	8 bits	

- Request parameters:
- Address: block addresses from 0 to 15, or 255
- Data 1: Less significant data byte
- Data 2: Data byte
- Data 3: Data byte
- Data 4: Most significant data byte.

Figure 40. Write_block response format

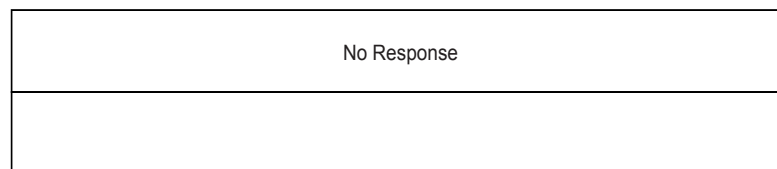
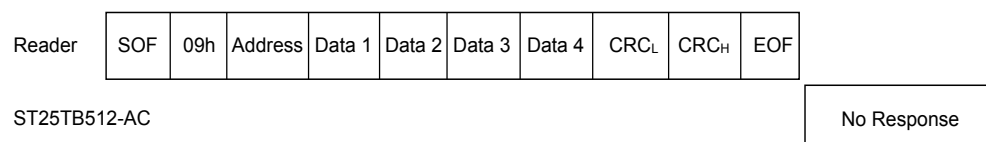

Figure 41. Write_block frame exchange between reader and ST25TB512-AC



AI108911

8.9 Get_UID() command

Command code = 0Bh

On receiving the Get_UID command, the **ST25TB512-AC** returns its 8 UID bytes. UID bytes are transmitted with the least significant byte first, and each byte is transmitted with the least significant bit first.

The **ST25TB512-AC** must have received a Select() command and be switched to Selected state before any Get_UID() command can be accepted. All Get_UID() commands sent to the **ST25TB512-AC** before a Select() command is issued, are ignored.

Figure 42. Get_UID request format

SOF	Get_UID	CRC _L	CRC _H	EOF
	0Bh	8 bits	8 bits	

Request parameter:

- No parameter

Figure 43. Get_UID response format

SOF	UID 0	UID 1	UID 2	UID 3	UID 4	UID 5	UID 6	UID 7	CRC _L	CRC _H	EOF
	8 bits	8 bits	8 bits	8 bits	8 bits	8 bits	8 bits	8 bits	8 bits	8 bits	

Response parameters:

- UID 0: Less significant UID byte
- UID 1 to UID 6: UID bytes
- UID 7: Most significant UID byte.

Unique identifier (UID)

Members of the **ST25TB512-AC** family are uniquely identified by a 64-bit unique identifier (UID). This is used for addressing each **ST25TB512-AC** device uniquely after the anticollision loop. The UID complies with ISO/IEC 15963 and ISO/IEC 7816-6. It is a read-only code, and comprises (as summarized in [Figure 44. 64-bit unique identifier of the ST25TB512-AC](#)):

- an 8-bit prefix, with the most significant bits set to D0h
- an 8-bit IC manufacturer code (ISO/IEC 7816-6/AM1) set to 02h (for STMicroelectronics)
- a 8-bit product ref code set to 1Bh for **ST25TB512-AC**
- a 40-bit unique serial number

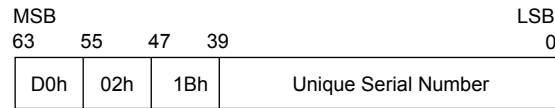
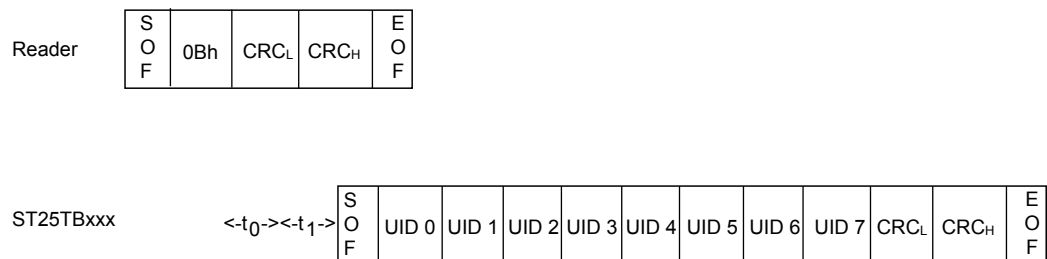
Figure 44. 64-bit unique identifier of the ST25TB512-AC

Figure 45. Get_UID frame exchange between reader and ST25TB512-AC

8.10 Power-on state

After power-on, the **ST25TB512-AC** is in the following state:

- It is in the low-power state.
- It is in Ready state.
- It shows highest impedance with respect to the reader antenna field.
- It will not respond to any command except Initiate().

9 Maximum ratings

Stressing the device above the ratings listed in the absolute maximum ratings table may cause permanent damage to the device. These are stress ratings only and operation of the device at these or any other conditions above those indicated in the operating sections of this specification is not implied. Exposure to absolute maximum ratings conditions for extended periods may affect device reliability. Refer also to the STMicroelectronics SURE Program and other relevant quality documents.

Table 11. Absolute maximum ratings

Symbol	Parameter		Min.	Max.	Unit
T _{STG} , t _{STG}	Storage conditions	Sawn wafer	15	25	°C
		(kept in its original packing form)	-	9 ⁽¹⁾	months
		Unsawn wafer	19	25	°C
		(kept in its antistatic bag)	-	23	months
I _{CC}	Supply current on AC0 / AC1	-	-	40	mA
V _{MAX} ⁽²⁾	RF input voltage amplitude between AC0 and AC1, GND pad left floating	-	-	10	V
V _{ESD}	Electrostatic discharge voltage	Human Body Model ⁽³⁾	-	2000	V

1. Counted from ST shipment date.
2. Based on characterization, not tested in production.
3. Positive and negative pulses applied on different combinations of pin connections, according to AEC-Q100-002 (compliant with ANSI/ESDA/JEDEC JS-001-2012, C1=100 pF, R1=1500 Ω, R2=500 Ω).

10 RF electrical parameters

Table 12. Operating conditions

Symbol	Parameter	Min.	Max.	Unit
T _A	Ambient operating temperature	-40	85	°C

Table 13. Electrical characteristics

Symbol	Parameter	Condition	Min	Typ	Max	Unit
H_ISO	Operating field according to ISO	T _A = 0 °C to 50 °C	1500	-	7500	mA/m
H_extended	Operating field in extended temperature range	T _A = -40 °C to 85 °C	1500	-	7500	
V _{RET}	Back-scattering induced voltage	ISO 10373-6	20	-	-	mV
C _{TUN}	Internal tuning capacitor	13.56 MHz ⁽¹⁾	62	68	74	pF

1. The tuning capacitance value is measured with ST characterization equipment at chip Power On Reset. This value is to be used as reference for antenna design. Min and Max value are deduced from correlation with industrial tester limits.

Note:

For inlay implementation, the antenna design applied for SRI512 can be re-used as-is for **ST25TB512-AC**: typical 68pF value for the **ST25TB512-AC** is equivalent to what was specified in the SRI512 data-sheet as 64pF. This change is related to a different measurement methodology between SRI512 and **ST25TB512-AC**.

Table 14. RF characteristics

Symbol	Parameter	Condition	Min	Typ	Max	Unit
f _{CC}	RFcarrier frequency	-	13.553	-	13.567	MHz
MI _{CARRIER}	Carrier modulation index	MI=(A-B)/(A+B)	8	11	14	%
t _{RFR} , t _{RFF}	10% Rise and Fall times	-	0.1	-	1.25	µs
t _{RFSBL}	Minimum pulse width for Start bit	ETU = 128/f _{CC}	-	9.44	-	µs
t _{JIT}	ASK modulation data jitter	Coupler to ST25TB512-AC	-2	-	+2	µs
t _{MIN CD}	Minimum timefrom carrier generation to first data	-	5	-	-	ms
f _S	Subcarrier frequency	f _{CC} /16	-	847.5	-	kHz
t ₀	Antenna reversal delay	-	-	159	-	µs
t ₁	Synchronization delay	-	-	151	-	µs
t ₂	Answer to new request delay	14 ETU	132	-	-	µs
t _{DR}	Time between request characters	Coupler to ST25TB512-AC	0	-	57	µs
t _{DA}	Time between answer characters	ST25TB512-AC to coupler	-	0	-	µs
t _W	Programming time for write	With no auto-erase cycle (OTP)	-	-	3	ms
		With auto-erase cycle (EEPROM)	-	-	5	ms
		Binarycounter decrement with tearing condition	-	-	7	ms

Note: All timing measurements were performed on a reference antenna with the following characteristics:

- External size: 76 mm x 46 mm
- Number of turns: 4
- Width of conductor: 0.9 mm
- Space between 2 conductors: 0.9 mm
- Tuning Frequency: 13.58 MHz

Figure 46. ST25TB512-AC synchronous timing, transmit and receive

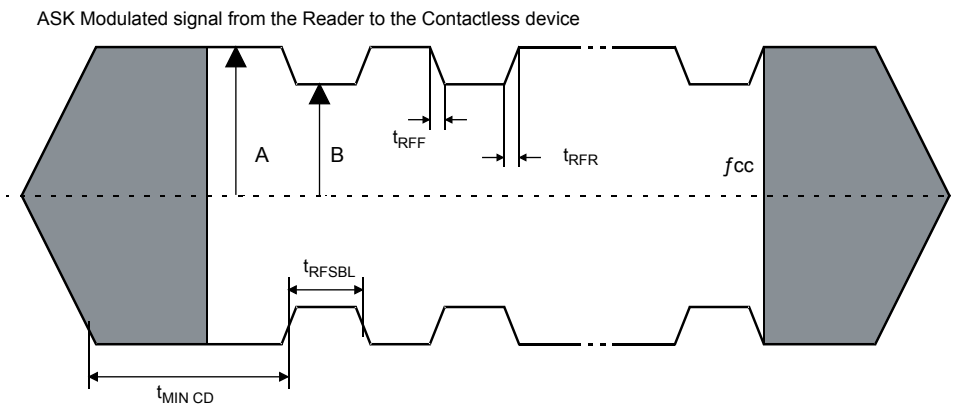

FRAME Transmission between the reader and the contactless device

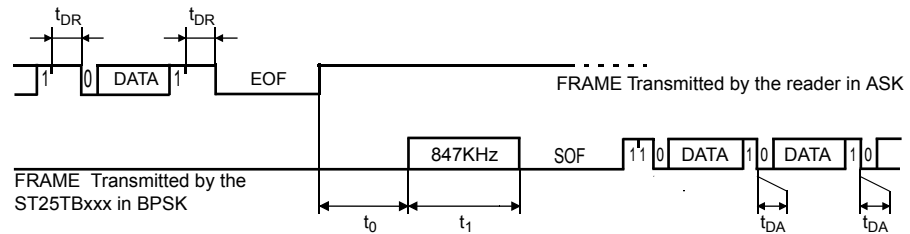

Data jitter on FRAME Transmitted by the reader in ASK

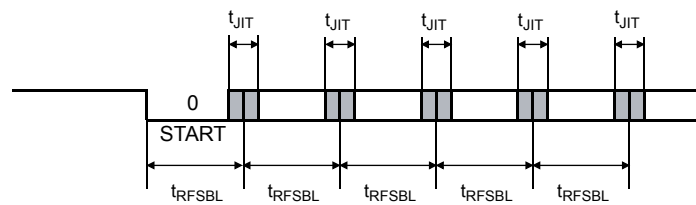

11 Ordering information

Table 15. Ordering information scheme

Example:	ST25	T	B	512	-A	C	6	G	6
Device type									
ST25 = RF memory									
Product type									
T = Tags + RFID									
Protocol									
B = ISO14443-B									
Memory density									
512 (binary)									
Interface									
A = None									
Features									
C = Counter as option									
Device grade									
6 = - 40 to 85 °C									
Package/Packaging									
G = Bumped 120 µm									
U = Unsawn 725 µm									
Capacitor value									
6 = 68 pF									

Note: Devices are shipped from the factory with the memory content bits erased to 1.

Note: Parts marked as “ES”, “E” or accompanied by an Engineering Sample notification letter, are not yet qualified and therefore not yet ready to be used in production and any consequences deriving from such usage will not be at ST charge. In no event, ST will be liable for any customer usage of these engineering samples in production. ST Quality has to be contacted prior to any decision to use these Engineering samples to run qualification activity.

A ISO-14443 Type B CRC calculation

```

#include <stdio.h>
#include <stdlib.h>
#include <string.h>
#include <ctype.h>
#define BYTE unsigned char
#define USHORT unsigned short
unsigned short UpdateCrc(BYTE ch, USHORT *lpwCrc)
{
  ch = (ch^(BYTE)((*lpwCrc) & 0x00FF));
  ch = (ch^(ch<<4));
  *lpwCrc = (*lpwCrc >> 8)^((USHORT)ch <<
  8)^((USHORT)ch<<3)^((USHORT)ch>>4);
  return(*lpwCrc);
}
void ComputeCrc(char *Data, int Length, BYTE *TransmitFirst, BYTE
*TransmitSecond)
{
  BYTE chBlock; USHORT wCrc;
  wCrc = 0xFFFF; // ISO 3309
  do
  {
    chBlock = *Data++;
    UpdateCrc(chBlock, &wCrc);
  } while (--Length);
  wCrc = ~wCrc; // ISO 3309
  *TransmitFirst = (BYTE) (wCrc & 0xFF);
  *TransmitSecond = (BYTE) ((wCrc >> 8) & 0xFF);
  return;
}
int main(void)
{
  BYTE BuffCRC_B[10] = {0x0A, 0x12, 0x34, 0x56}, First, Second, i;
  printf("Crc-16 G(x) = x^16 + x^12 + x^5 + 1");
  printf("CRC_B of [ ");
  for(i=0; i<4; i++)
  printf("%02X ",BuffCRC_B[i]);
  ComputeCrc(BuffCRC_B, 4, &First, &Second);
  printf("] Transmitted: %02X then %02X.", First, Second);
  return(0);
}

```

B ST25TB512-AC command brief

Figure 47. Initiate frame exchange between reader and ST25TB512-AC

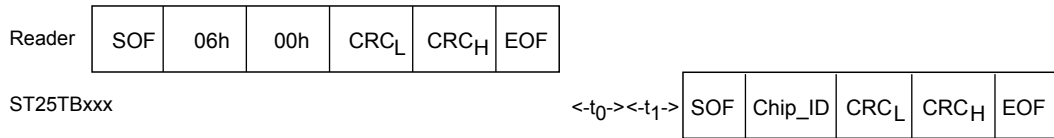

Figure 48. Pcall16 frame exchange between reader and ST25TB512-AC

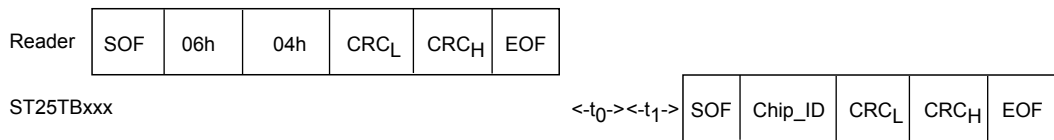

Figure 49. Slot_marker frame exchange between reader and ST25TB512-AC



Figure 50. Select frame exchange between reader and ST25TB512-AC

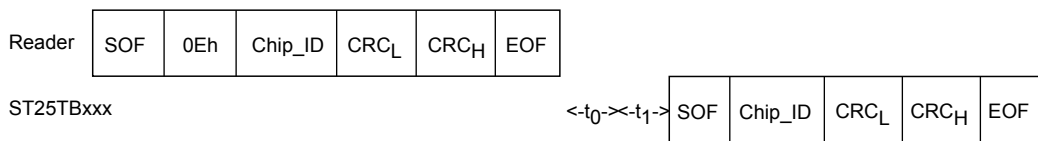

Figure 51. Completion frame exchange between reader and ST25TB512-AC

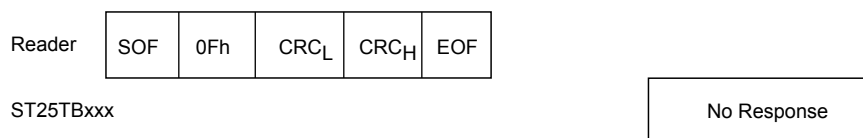

Figure 52. Reset_to_inventory frame exchange between reader and ST25TB512-AC

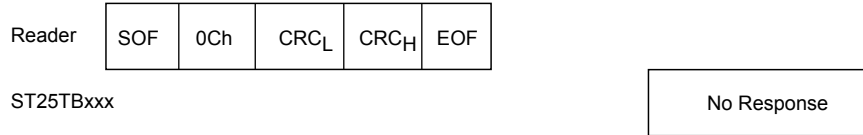

Figure 53. Read_block frame exchange between reader and ST25TB512-AC

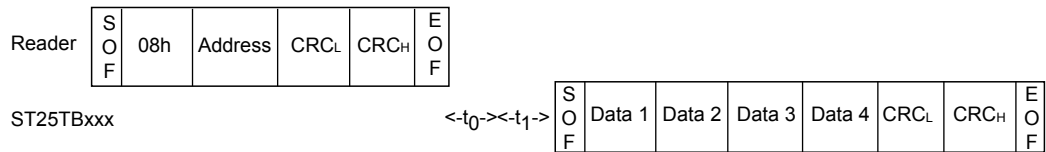

Figure 54. Write_block frame exchange between reader and ST25TB512-AC

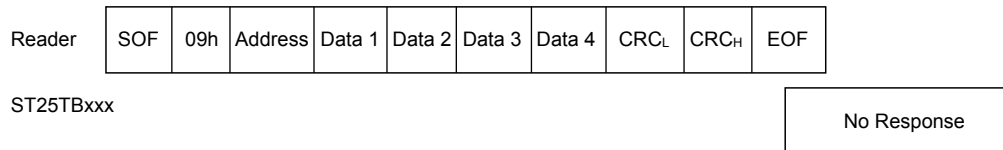
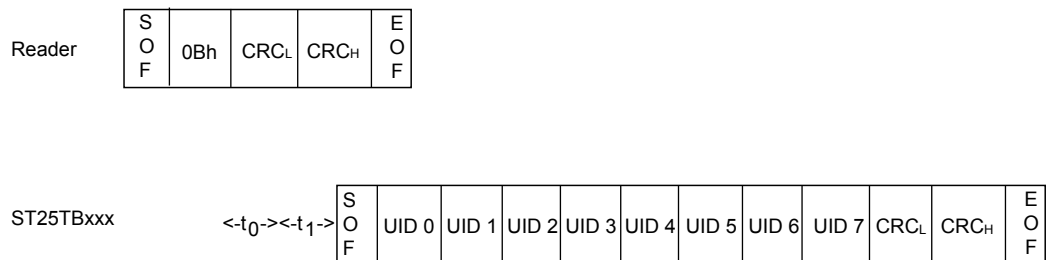

Figure 55. Get_UID frame exchange between reader and ST25TB512-AC



Revision history

Table 16. Document revision history

Date	Version	Changes
09-Feb-2016	1	Initial release
03-Mar-2016	2	Updated Figure 28 and Figure 41.
19-Apr-2016	3	Changed confidentiality level from ST restricted to public.
01-Sep-2016	4	Updated Figure 46: ST25TB512-AC synchronous timing, transmit and receive, Table 11: Absolute maximum ratings and Table 15: Ordering information scheme (bumped and sawn wafer)
21-Sept-2016	5	Updated Section 8.9: Get_UID() command, Table 11: Absolute maximum ratings, Table 15: Ordering information scheme (bumped and sawn wafer) and Figure 44: 64-bit unique identifier of the ST25TB512-AC
18-Oct-2016	6	Updated Features in cover page
27-Sep-2018	7	Updated Section 4.1 EEPROM area .
16-Oct-2018	8	Updated Section 8.9 Get_UID() command

Contents

1	Description	2
2	Signal description	4
2.1	AC1, AC0	4
3	Data transfer	5
3.1	Input data transfer from reader to ST25TB512-AC (request frame)	5
3.1.1	Character transmission format for request frame	5
3.1.2	Request start of frame	5
3.1.3	Request end of frame	6
3.2	Output data transfer from ST25TB512-AC to reader (answer frame)	7
3.2.1	Character transmission format for answer frame	7
3.2.2	Answer start of frame	7
3.2.3	Answer end of frame	8
3.3	Transmission frame	8
3.4	CRC	9
4	Memory mapping	10
4.1	EEPROM area	11
4.1.1	Block 0 - 4: resettable OTP area	11
4.1.2	Block 7 - 15	12
4.2	32-bit binary counters	13
4.3	System area	14
4.3.1	OTP_Lock_Reg	14
5	ST25TB512-AC operation	15
6	ST25TB512-AC states	16
6.1	Power-off state	16
6.2	Ready state	16
6.3	Inventory state	16
6.4	Selected state	16
6.5	Deselected state	16
6.6	Deactivated state	17

7	Anticollision	18
7.1	Description of an anticollision sequence	19
8	ST25TB512-AC commands	22
8.1	Initiate() command	23
8.2	Pcall16() command	24
8.3	Slot_marker(SN) command	25
8.4	Select(Chip_ID) command	26
8.5	Completion() command	27
8.6	Reset_to_inventory() command	28
8.7	Read_block(Addr) command	29
8.8	Write_block (Addr, Data) command	30
8.9	Get_UID() command	31
8.10	Power-on state	32
9	Maximum ratings	33
10	RF electrical parameters	34
11	Ordering information	36
A	ISO-14443 Type B CRC calculation	37
B	ST25TB512-AC command brief	38
	Revision history	40

List of tables

Table 1.	Signal names	2
Table 2.	Bit description	5
Table 3.	ST25TB512-AC memory mapping	10
Table 4.	Resettable OTP area (addresses 0 to 4)	11
Table 5.	EEPROM area (addresses 7 to 15)	12
Table 6.	Binary counter (addresses 5 to 6)	13
Table 7.	System area	14
Table 8.	Standard anticollision sequence	20
Table 9.	Example of an anticollision sequence	20
Table 10.	Command code	22
Table 11.	Absolute maximum ratings	33
Table 12.	Operating conditions	34
Table 13.	Electrical characteristics	34
Table 14.	RF characteristics	34
Table 15.	Ordering information scheme	36
Table 16.	Document revision history	40

List of figures

Figure 1.	Logic diagram	2
Figure 2.	Die floor plan and assembly options	3
Figure 3.	ST25TB512-AC 10% ASK modulation of the received wave	5
Figure 4.	ST25TB512-AC request frame character format	5
Figure 5.	Request start of frame	6
Figure 6.	Request end of frame	6
Figure 7.	Wave transmitted using BPSK subcarrier modulation	7
Figure 8.	Answer start of frame	7
Figure 9.	Answer end of frame	8
Figure 10.	Example of a complete transmission frame	8
Figure 11.	CRC transmission rules	9
Figure 12.	Write_block update in Standard mode (binary format)	11
Figure 13.	Write_block update in Reload mode (binary format)	12
Figure 14.	Countdown example (binary format)	13
Figure 15.	State transition diagram	17
Figure 16.	ST25TB512-AC Chip_ID description	18
Figure 17.	Description of a possible anticollision sequence	19
Figure 18.	Initiate request format	23
Figure 19.	Initiate response format	23
Figure 20.	Initiate frame exchange between reader and ST25TB512-AC	23
Figure 21.	Pcall16 request format	24
Figure 22.	Pcall16 response format	24
Figure 23.	Pcall16 frame exchange between reader and ST25TB512-AC	24
Figure 24.	Slot_marker request format	25
Figure 25.	Slot_marker response format	25
Figure 26.	Slot_marker frame exchange between reader and ST25TB512-AC	25
Figure 27.	Select request format	26
Figure 28.	Select response format	26
Figure 29.	Select frame exchange between reader and ST25TB512-AC	26
Figure 30.	Completion request format	27
Figure 31.	Completion response format	27
Figure 32.	Completion frame exchange between reader and ST25TB512-AC	27
Figure 33.	Reset_to_inventory request format	28
Figure 34.	Reset_to_inventory response format	28
Figure 35.	Reset_to_inventory frame exchange between reader and ST25TB512-AC	28
Figure 36.	Read_block request format	29
Figure 37.	Read_block response format	29
Figure 38.	Read_block frame exchange between reader and ST25TB512-AC	29
Figure 39.	Write_block request format	30
Figure 40.	Write_block response format	30
Figure 41.	Write_block frame exchange between reader and ST25TB512-AC	30
Figure 42.	Get_UID request format	31
Figure 43.	Get_UID response format	31
Figure 44.	64-bit unique identifier of the ST25TB512-AC	32
Figure 45.	Get_UID frame exchange between reader and ST25TB512-AC	32
Figure 46.	ST25TB512-AC synchronous timing, transmit and receive	35
Figure 47.	Initiate frame exchange between reader and ST25TB512-AC	38
Figure 48.	Pcall16 frame exchange between reader and ST25TB512-AC	38
Figure 49.	Slot_marker frame exchange between reader and ST25TB512-AC	38
Figure 50.	Select frame exchange between reader and ST25TB512-AC	38
Figure 51.	Completion frame exchange between reader and ST25TB512-AC	38
Figure 52.	Reset_to_inventory frame exchange between reader and ST25TB512-AC	39

Figure 53.	Read_block frame exchange between reader and ST25TB512-AC	39
Figure 54.	Write_block frame exchange between reader and ST25TB512-AC	39
Figure 55.	Get_UID frame exchange between reader and ST25TB512-AC	39

IMPORTANT NOTICE – PLEASE READ CAREFULLY

STMicroelectronics NV and its subsidiaries (“ST”) reserve the right to make changes, corrections, enhancements, modifications, and improvements to ST products and/or to this document at any time without notice. Purchasers should obtain the latest relevant information on ST products before placing orders. ST products are sold pursuant to ST’s terms and conditions of sale in place at the time of order acknowledgement.

Purchasers are solely responsible for the choice, selection, and use of ST products and ST assumes no liability for application assistance or the design of Purchasers’ products.

No license, express or implied, to any intellectual property right is granted by ST herein.

Resale of ST products with provisions different from the information set forth herein shall void any warranty granted by ST for such product.

ST and the ST logo are trademarks of ST. All other product or service names are the property of their respective owners.

Information in this document supersedes and replaces information previously supplied in any prior versions of this document.

© 2018 STMicroelectronics – All rights reserved

X-ON Electronics

Largest Supplier of Electrical and Electronic Components

Click to view similar products for [EEPROM](#) category:

Click to view products by [STMicroelectronics](#) manufacturer:

Other Similar products are found below :

[M29F040-70K6](#) [718278CB](#) [718620G](#) [444358RB](#) [444362FB](#) [BR93C46-WMN7TP](#) [EEROMH](#) [CAT25320YIGT-KK](#) [LE24C162-R-E](#) [5962-8751409YA](#) [BR9016AF-WE2](#) [LE2464DXATBG](#) [CAS93C66VP2I-GT3](#) [W60002FT20T](#) [CAT24S128C4UTR](#) [ZD24C64B-SSGMA0](#) [BL24C04F-RRRC](#) [S-25C040A0I-I8T1U](#) [AT24C256BY7-YH-T](#) [M24C64-DFCT6TPK](#) [BR24C21FJ-E2](#) [BR24G02FVJ-3GTE2](#) [BR24L16FJ-WE2](#) [BR24L16FVJ-WE2](#) [BR24S16FJ-WE2](#) [BR24S256F-WE2](#) [BR93L56RFV-WE2](#) [BR93L66F-WE2](#) [BR93L76RFV-WE2](#) [CAT24C64C4CTR](#) [CHL24C32WEGT3](#) [AT28HC256E-12SU-T](#) [AT93C46DY6-YH-T](#) [BR24T02FVT-WSGE2](#) [M35B32-WMN6TP](#) [M24C64-FMC6TG](#) [M24C08-WDW6TP](#) [CAT25080VP2IGTQH](#) [CAT25020ZIGT-QP](#) [CAT24C01VP2I-GT3](#) [CAT93C76BZI-GT3](#) [CAT64LC40WI-T3](#) [CAT25256HU4E-GT3](#) [CAT25128VP2I-GT3](#) [CAT25040VP2I-GT3](#) [CAT25020VP2I-GT3](#) [CAT24C16ZI-G](#) [CAT24C05LI-G](#) [CAT24C01ZI-G](#) [CAT24C05WI-G](#)