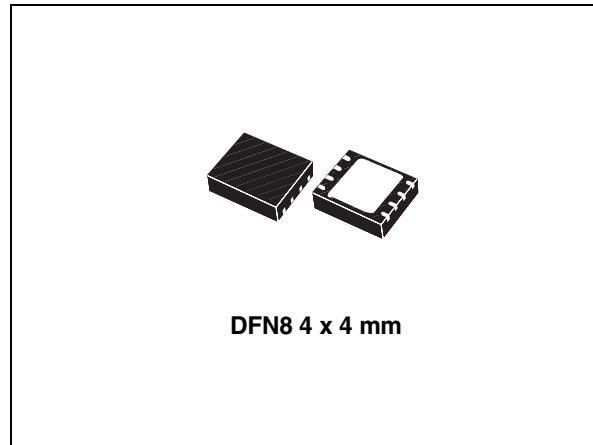

Micropower 1 A synchronous step-up DC-DC converter

Features

- Output voltage adjustable from 6 V to 12 V
- Output voltage accuracy: $\pm 2\%$
- Output current up to 1 A
- Low ripple voltage: 5 mV (typ.)
- Synchronous rectification
- High 90% efficiency: $V_O = 9\text{ V}$ (typ.)
- Few external components
- Thermal shutdown protection
- Very small DFN8 (4 x 4 mm) package

**Description**

The ST8R00 is a synchronous PWM step-up DC-DC converter. The device is able to provide an output voltage in the range of 6 to 12 V with an input voltage from 4 to 6 V. The high switching frequency (1.7 MHz) permits the use of tiny surface-mount components. In addition to the resistor divider to set the output voltage value, only an inductor and two capacitors are required. Moreover, a low output ripple is guaranteed by the current mode PWM topology and by the use of low ESR SMD ceramic capacitors. The device is available in a very small DFN8 (4 x 4 mm) package.

Table 1. Device summary

Part number	Order code	Output voltage
ST8R00	ST8R00WPUR	ADJ

Contents

1	Block diagram	3
2	Pin configuration	4
3	Typical application circuit	5
4	Maximum ratings	6
5	Electrical characteristics	7
6	Typical characteristics	8
7	Package mechanical data	13
8	Revision history	17

1 Block diagram

Figure 1. Schematic diagram

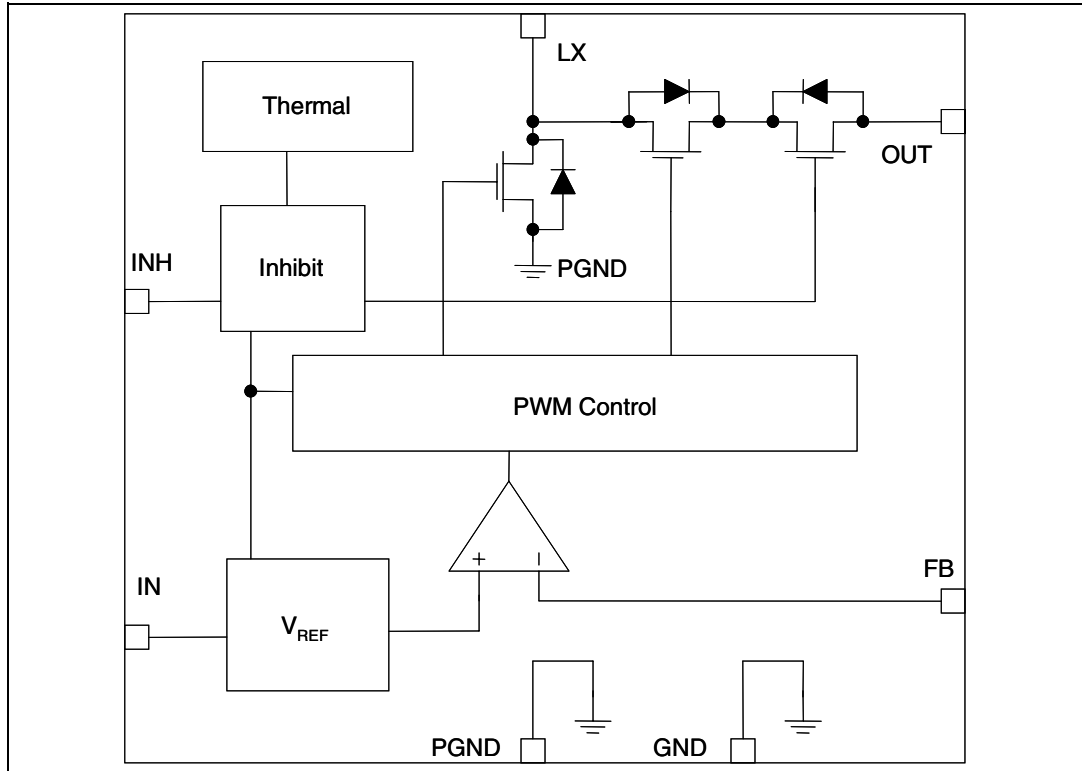

2 Pin configuration

Figure 2. Pin connections (top view)

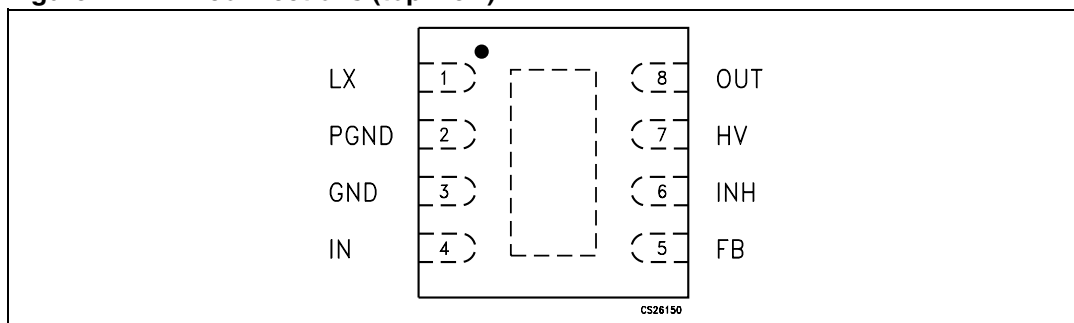
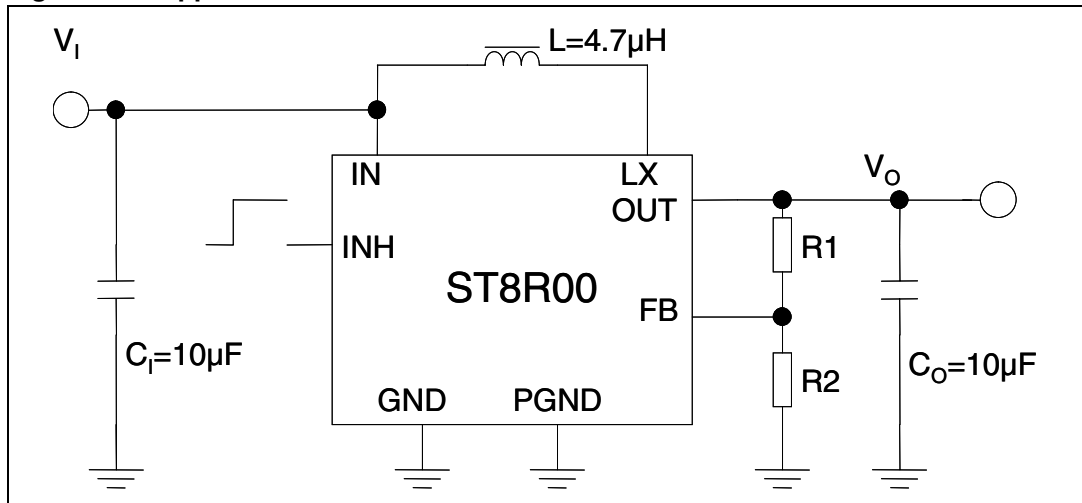

Table 2. Pin description

Pin n°	Symbol	Name and function
1	LX	Switching output
2	PGND	Power ground
3	GND	Analog ground
4	IN	Power input for analog circuit
5	FB	Feedback
6	INH	Inhibit. Connecting the pin to a voltage higher than 2 V = device ON. Connecting the pin to a voltage lower than 0.8 V = device OFF, resulting in no current flow to the load
7	HV	Trimming (floating or connected to GND)
8	OUT	Output voltage
EXP pad	GND	Exposed pad. Must be connected to GND

3 Typical application circuit

Figure 3. Application circuit



4 Maximum ratings

Table 3. Absolute maximum ratings

Symbol	Parameter	Value	Unit
V_O	Output voltage	16	V
V_I	Input voltage	6	V
V_{INH}	Inhibit voltage	6	V
V_{LX}	LX pin voltage	16	V
I_{LX}	LX pin output current	Internally limited	
T_{STG}	Storage temperature range	-50 to 150	°C
T_{OP}	Operating junction temperature range	-25 to 125	°C

Table 4. Thermal Data

Symbol	Parameter	Value	Unit
R_{thJC}	Thermal resistance junction-case	10	°C/W
R_{thJA}	Thermal resistance junction-ambient	50	°C/W

Table 5. ESD Performance

Symbol	Parameter	Test conditions	Value	Unit
ESD	ESD protection voltage	HBM	4	KV
ESD	ESD protection voltage	MM	500	V

5 Electrical characteristics

$V_I = 5\text{ V}$, $V_{INH} = 2\text{ V}$, $I_O = 100\text{ mA}$, $T_J = -25\text{ °C}$ to 125 °C , $C_I = C_O = 10\text{ }\mu\text{F(X7R)}$, $L = 4.7\text{ }\mu\text{H}$ unless otherwise specified.

Table 6. Electrical characteristics

Symbol	Parameter	Test conditions	Min.	Typ.	Max.	Unit
V_O	Output voltage	(1)	6		12	V
$V_{START-UP}$	Start-up voltage	$I_O = 400\text{mA}$, V_I rising		3	3.5	V
V_I	Input voltage range		4		6	V
V_{FB}	Feedback voltage	$I_O = 50\text{mA}$	1.195	1.22	1.245	V
V_{FB_OFF}	Feedback voltage	$I_O = 0$, $V_{INH} = 0$		0		V
I_{FB}	Feedback current	$V_{FB} = 0$, $V_{INH} = 2\text{V}$		600		nA
I_{SUPPLY}	Supply current	To be measured at V_I , $V_O = 7\text{V}$, no load		10		mA
R_{DSON_N}	Internal N channel R_{DSON}	$I_{LX} = 400\text{mA}$		300		m Ω
R_{DSON_P}	Internal P channel R_{DSON}	$I_{LX} = 400\text{mA}$		300		
$I_{LX(leak)}$	Internal leakage current	$V_{LX} = 4\text{V}$, $V_{FB} = 2\text{V}$, $V_{INH} = 0$			0.5	μA
$I_{LX(LIM)}$	LX current limitation	$V_{LX} = 4\text{V}$		3		A
f_{OSC}	Oscillator frequency	To be measured on LX pin	0.8	1.2	1.4	MHz
D_{TY}	Max. oscillator duty cycle	To be measured on LX pin		90		%
Eff	Efficiency	$I_O = 50\text{mA}$, $V_O = 7\text{V}$		85		%
		$I_O = 500\text{mA}$, $V_O = 9\text{V}$		90		
		$I_O = 1\text{A}$, $V_O = 9\text{V}$		90		
V_{INH_H}	Inhibit threshold high		2			V
V_{INH_L}	Inhibit threshold low	$V_I = 4$ to 6V , $I_O = 50\text{mA}$			0.8	
I_{INH}	Inhibit pin current	$V_{INH} = V_I = 5\text{V}$			2	μA
T_{SHDN}	Thermal shut down (2)		130	150		$^{\circ}\text{C}$
T_{HYS}	Thermal shut down hysteresis (2)			15		$^{\circ}\text{C}$
$\Delta V_O/\Delta V_I$	Line transient response	V_I from 4 to 5.5V, $I_O = 500\text{mA}$ (2)	-5		5	% V_O
$\Delta V_O/\Delta I_O$	Load transient response	$V_I = 5\text{V}$, I_O from 10mA to 500mA, $V_O = 7\text{V}$ (2)	-5		5	% V_O
$\Delta V_O/\Delta V_I$	Start-up transient	V_I from 0 to 5V, $I_O = 500\text{mA}$	-10		10	% V_O
T_{START}	Start-up time	V_{INH} from 0 to 5V, $I_O = 100\text{mA}$		500		μs

- For V_O higher than 9 V the maximum output current capability is reduced according to LX current limitation
- Guaranteed by design

6 Typical characteristics

$L = 4.7 \mu\text{H}$, $C_I = C_O = 10 \mu\text{F}$.

Figure 4. Voltage feedback vs. temperature

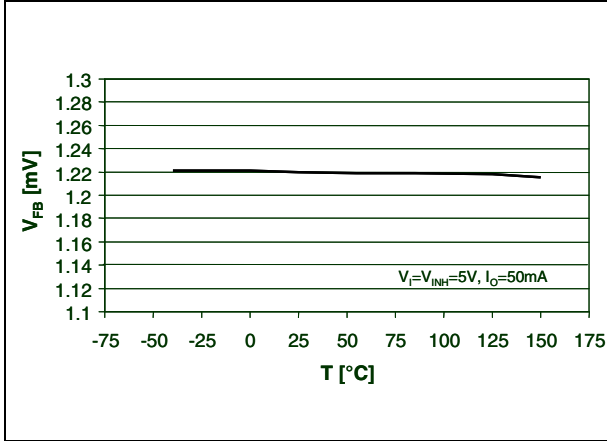

Figure 5. Feedback current vs. temperature

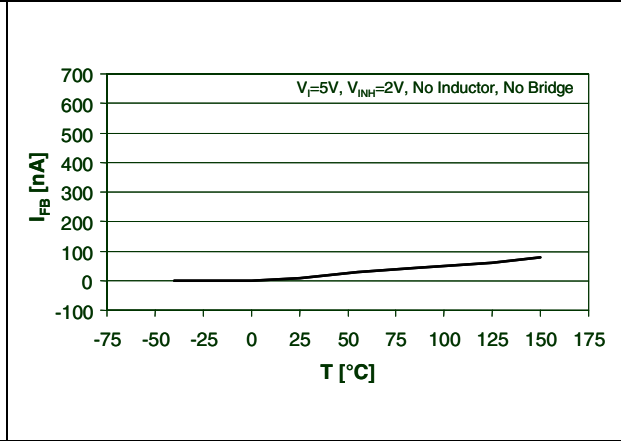

Figure 6. Supply current vs. temperature ($V_I = V_{INH} = 5 \text{ V}$)

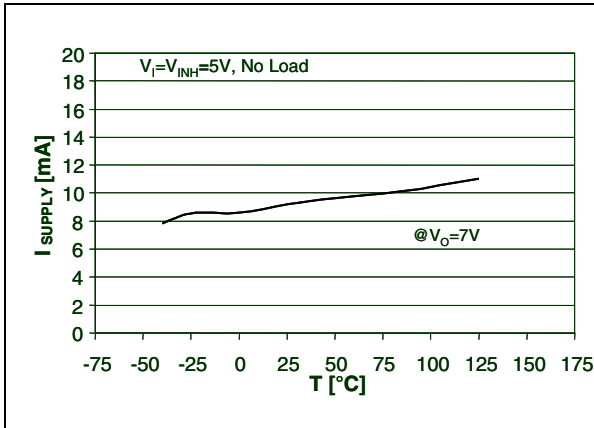

Figure 7. Supply current vs. temperature ($V_{INH} = 2 \text{ V}$)

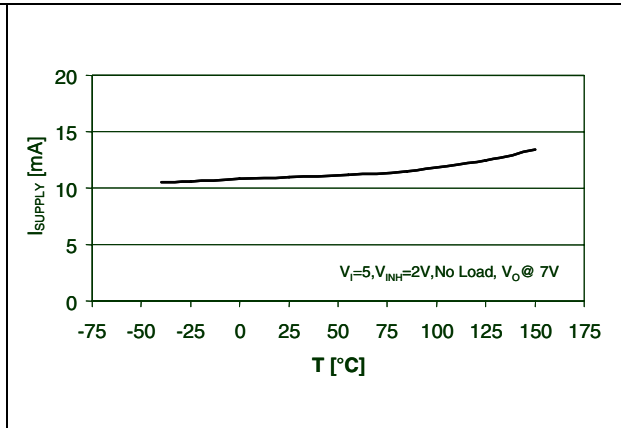

Figure 8. Supply current vs. temperature ($V_{FB} = 2 \text{ V}$)

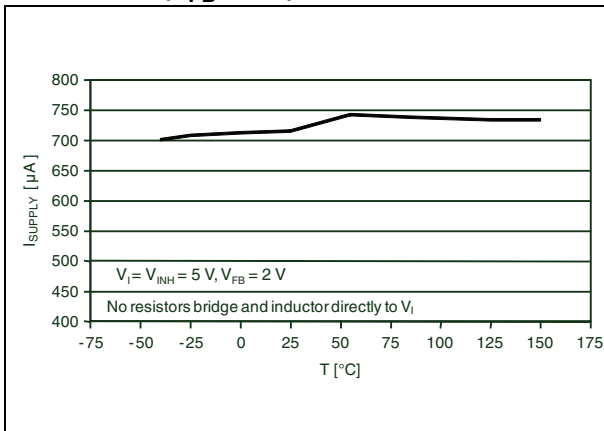

Figure 9. LX current limitation vs. temperature

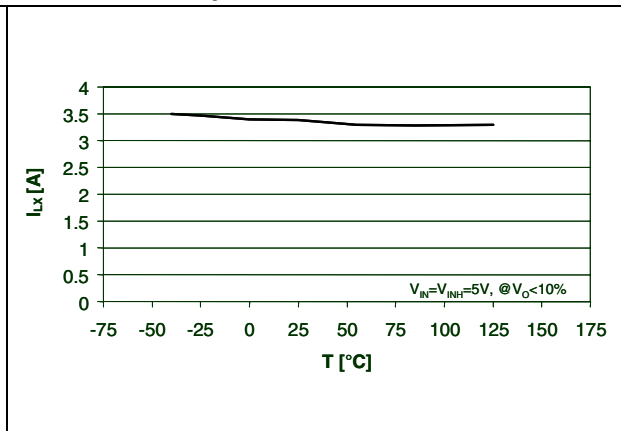

Figure 10. Inhibit voltage vs. temperature
($V_I = 4\text{ V}$)

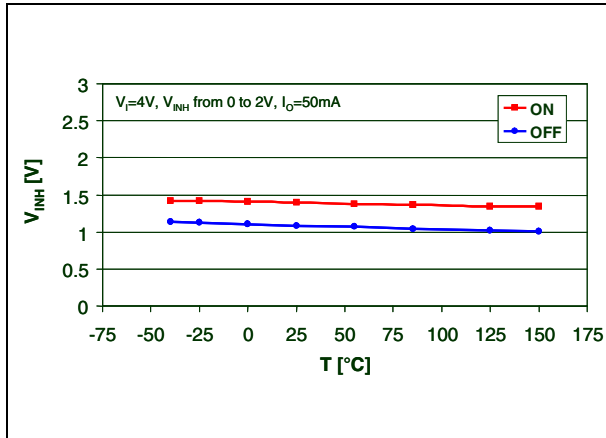

Figure 11. Inhibit voltage vs. temperature
($V_I = 6\text{ V}$)

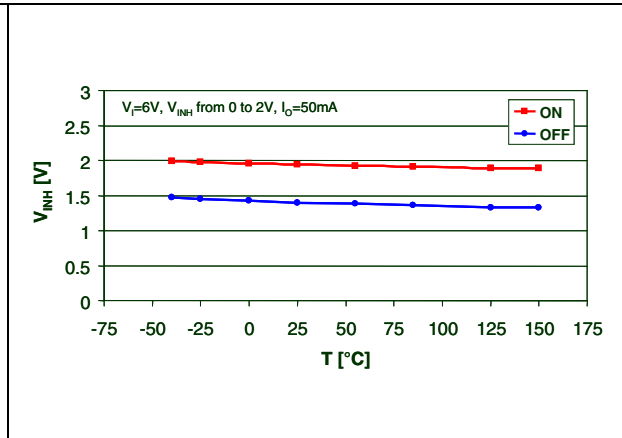

Figure 12. Line regulation vs. temperature

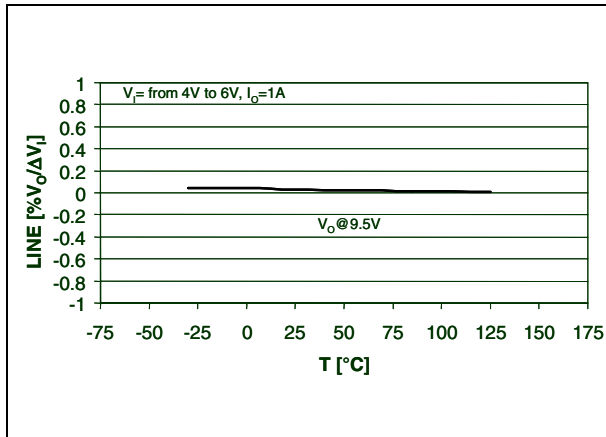

Figure 13. Load regulation vs. temperature

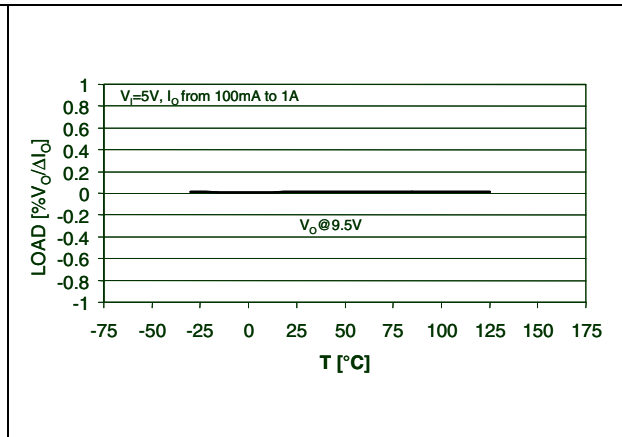

Figure 14. Oscillator frequency vs. temperature

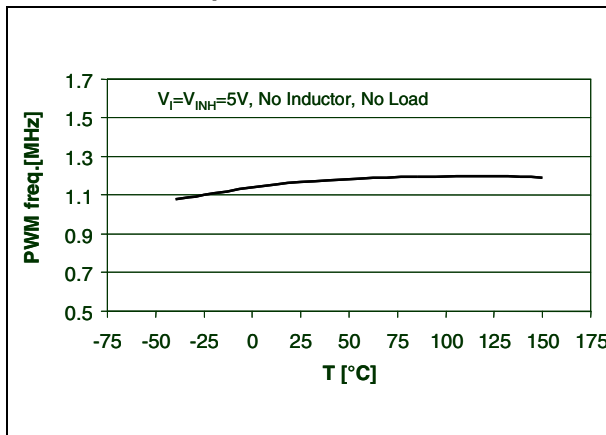

Figure 15. Max oscillator duty cycle vs. temperature

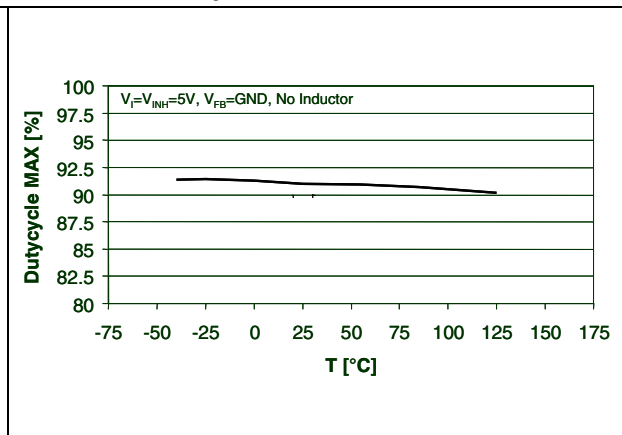

Figure 16. Internal leakage current vs. temperature ($V_I = V_{INH} = 5\text{ V}$)

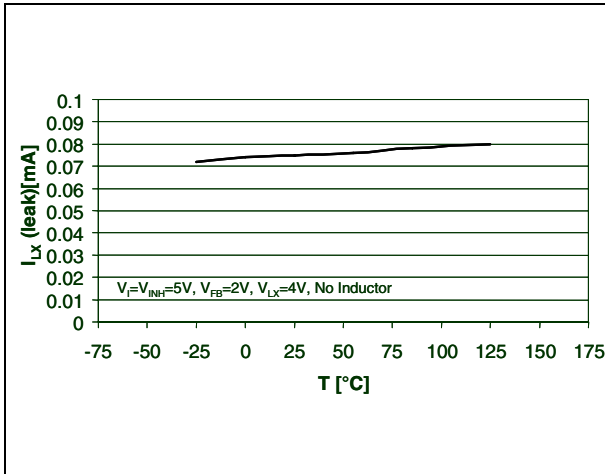

Figure 17. Internal leakage current vs. temperature ($V_I = 5\text{ V}$)

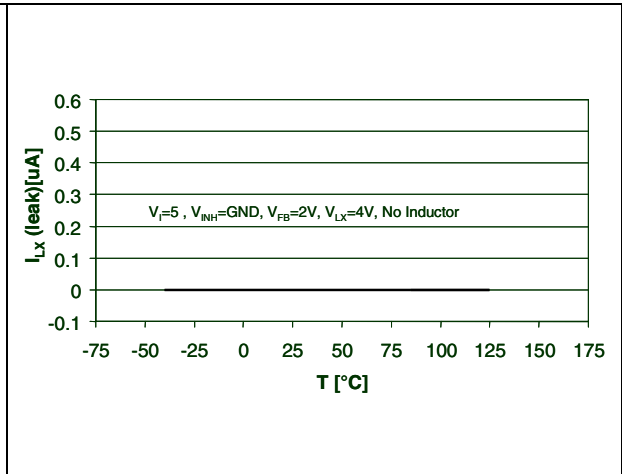

Figure 18. NMOS switch on resistance vs. temperature

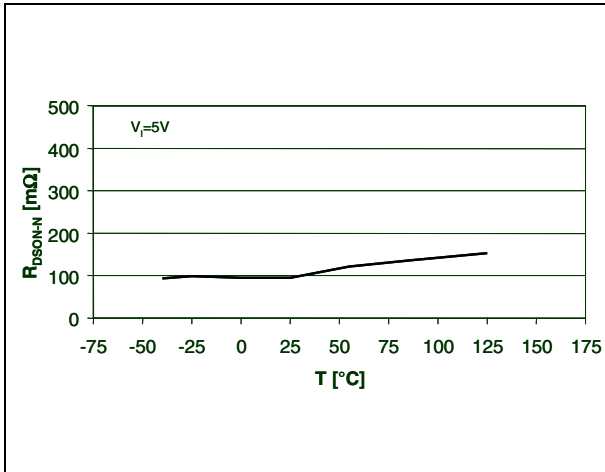

Figure 19. PMOS switch on resistance vs. temperature

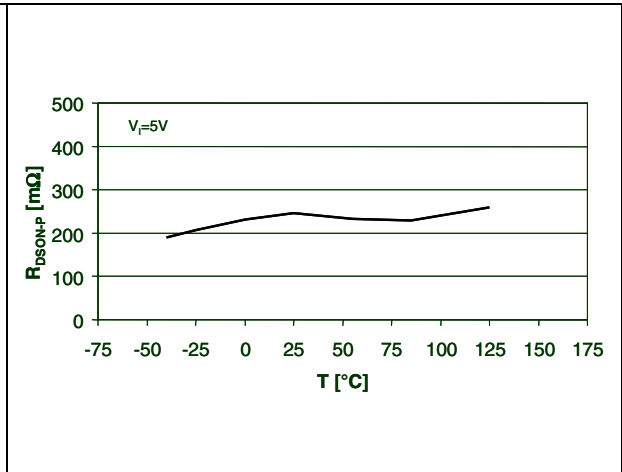

Figure 20. Efficiency vs. output current ($L = 10\text{ }\mu\text{H}$)

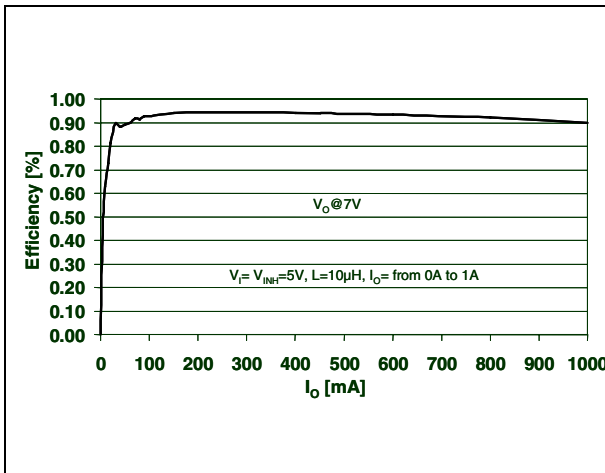

Figure 21. Efficiency vs. output current

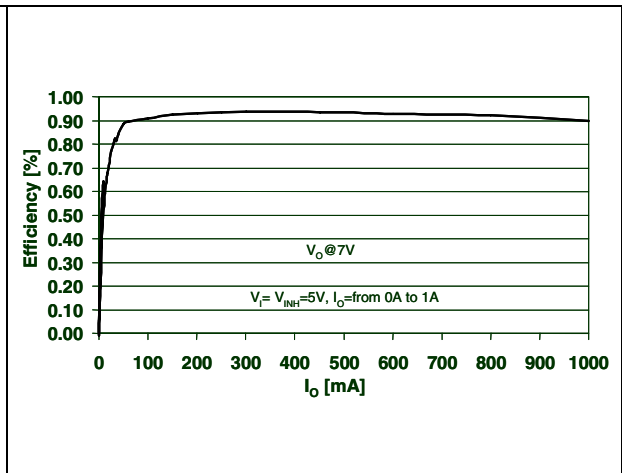

Figure 22. Output voltage vs. input voltage

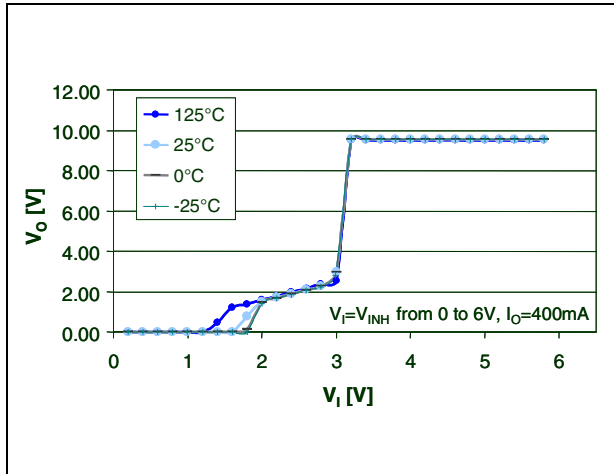

Figure 23. Maximum output current vs. output voltage

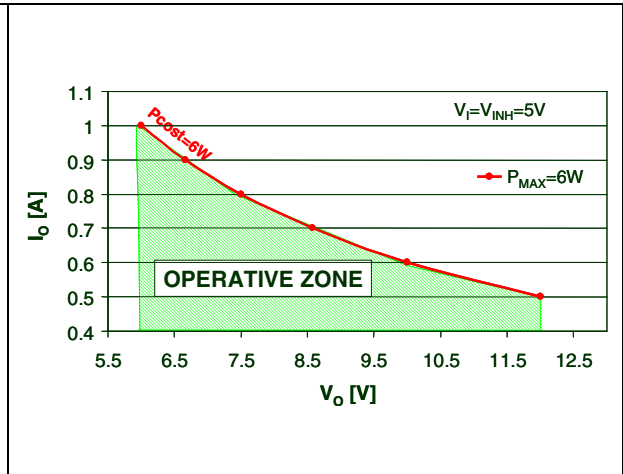

Figure 24. Inductor current

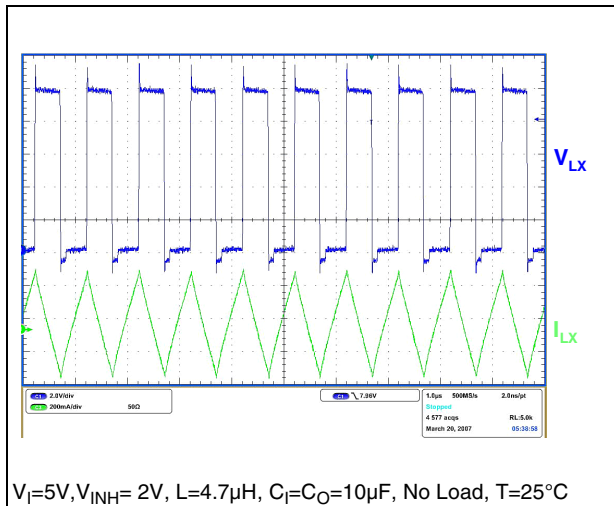

Figure 25. Load transient

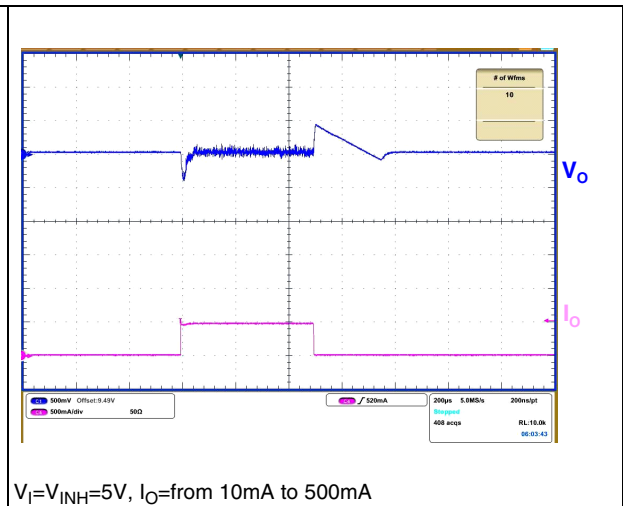

Figure 26. Line transient

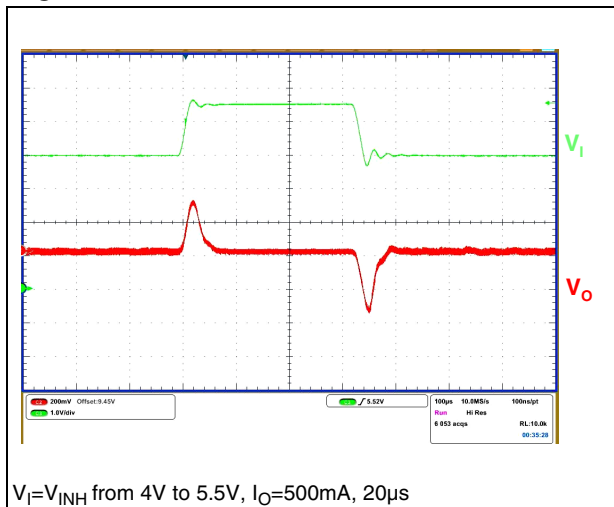

Figure 27. INH transient

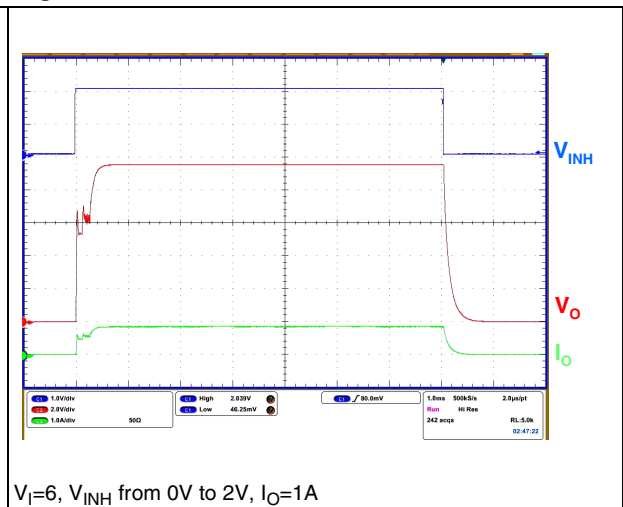
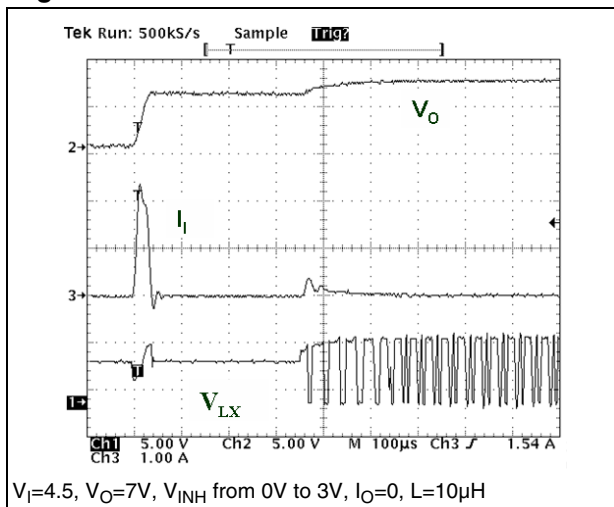

Figure 28. Inrush current



7 Package mechanical data

In order to meet environmental requirements, ST offers these devices in different grades of ECOPACK[®] packages, depending on their level of environmental compliance. ECOPACK[®] specifications, grade definitions and product status are available at: www.st.com. ECOPACK[®] is an ST trademark.

DFN8 (4x4) Mechanical Data

Dim.	mm.			inch.		
	Min.	Typ.	Max.	Min.	Typ.	Max.
A	0.80	0.90	1.00	0.031	0.035	0.039
A1	0	0.02	0.05	0	0.001	0.002
A3		0.20			0.008	
b	0.23	0.30	0.38	0.009	0.012	0.015
D	3.90	4.00	4.10	0.154	0.157	0.161
D2	2.82	3.00	3.23	0.111	0.118	0.127
E	3.90	4.00	4.10	0.154	0.157	0.161
E2	2.05	2.20	2.30	0.081	0.087	0.091
e		0.80			0.031	
L	0.40	0.50	0.60	0.016	0.020	0.024

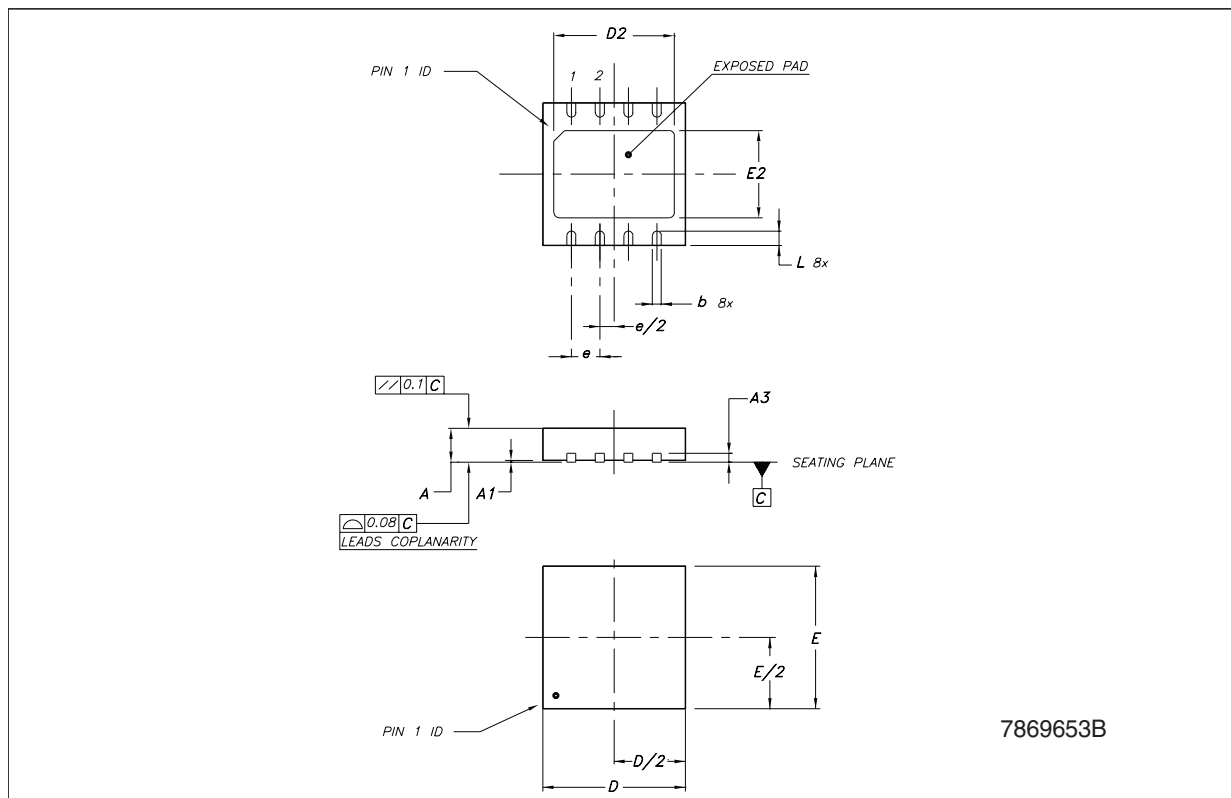
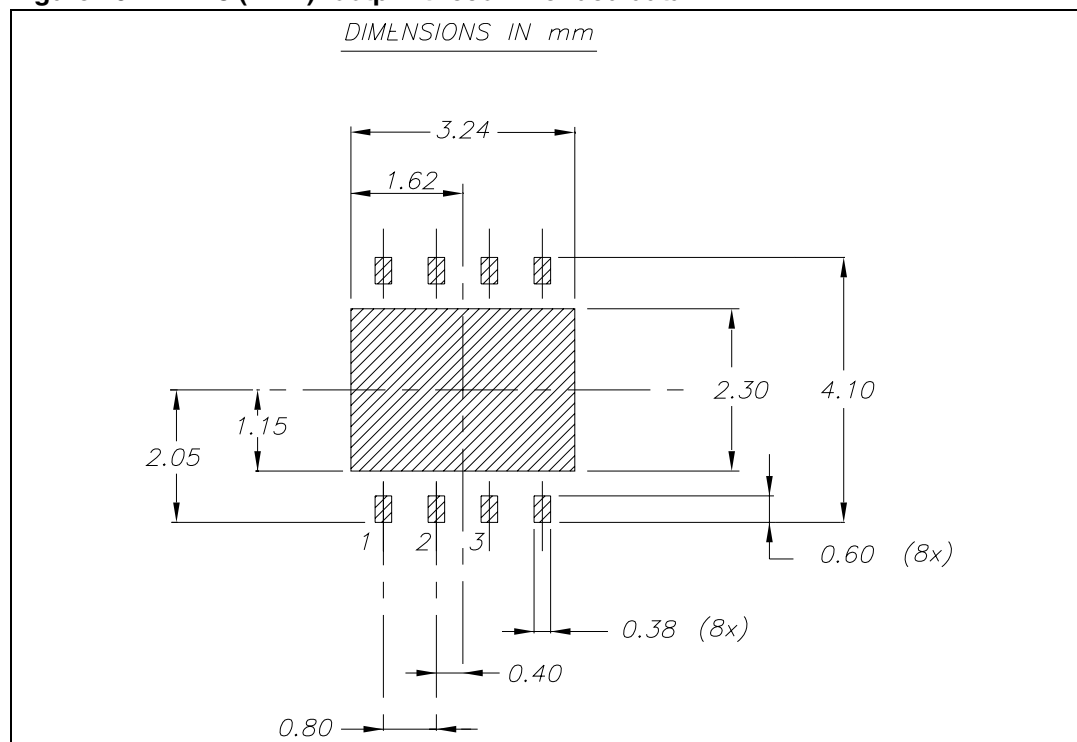
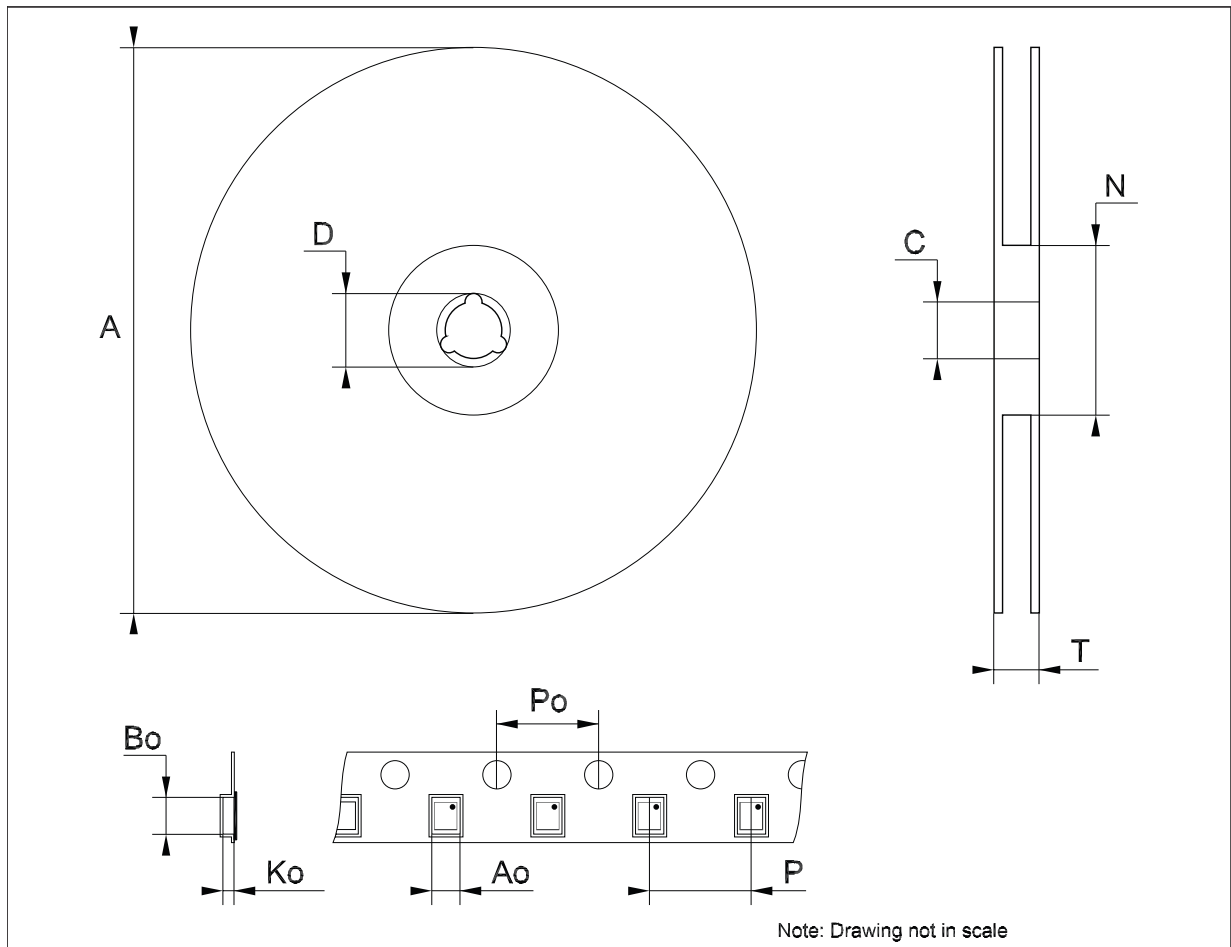

Figure 29. DFN8 (4 x 4) footprint recommended data

Tape & Reel QFNxx/DFNxx (4x4) Mechanical Data

Dim.	mm.			inch.		
	Min.	Typ.	Max.	Min.	Typ.	Max.
A			330			12.992
C	12.8		13.2	0.504		0.519
D	20.2			0.795		
N	99		101	3.898		3.976
T			14.4			0.567
Ao		4.35			0.171	
Bo		4.35			0.171	
Ko		1.1			0.043	
Po		4			0.157	
P		8			0.315	



8 Revision history

Table 7. Document revision history

Date	Revision	Changes
24-May-2007	1	Initial release.
01-Feb-2012	2	Modified: Figure 8 on page 8 . Removed: Table 6, Figures 24, 25 and 26.

Please Read Carefully:

Information in this document is provided solely in connection with ST products. STMicroelectronics NV and its subsidiaries ("ST") reserve the right to make changes, corrections, modifications or improvements, to this document, and the products and services described herein at any time, without notice.

All ST products are sold pursuant to ST's terms and conditions of sale.

Purchasers are solely responsible for the choice, selection and use of the ST products and services described herein, and ST assumes no liability whatsoever relating to the choice, selection or use of the ST products and services described herein.

No license, express or implied, by estoppel or otherwise, to any intellectual property rights is granted under this document. If any part of this document refers to any third party products or services it shall not be deemed a license grant by ST for the use of such third party products or services, or any intellectual property contained therein or considered as a warranty covering the use in any manner whatsoever of such third party products or services or any intellectual property contained therein.

UNLESS OTHERWISE SET FORTH IN ST'S TERMS AND CONDITIONS OF SALE ST DISCLAIMS ANY EXPRESS OR IMPLIED WARRANTY WITH RESPECT TO THE USE AND/OR SALE OF ST PRODUCTS INCLUDING WITHOUT LIMITATION IMPLIED WARRANTIES OF MERCHANTABILITY, FITNESS FOR A PARTICULAR PURPOSE (AND THEIR EQUIVALENTS UNDER THE LAWS OF ANY JURISDICTION), OR INFRINGEMENT OF ANY PATENT, COPYRIGHT OR OTHER INTELLECTUAL PROPERTY RIGHT.

UNLESS EXPRESSLY APPROVED IN WRITING BY TWO AUTHORIZED ST REPRESENTATIVES, ST PRODUCTS ARE NOT RECOMMENDED, AUTHORIZED OR WARRANTED FOR USE IN MILITARY, AIR CRAFT, SPACE, LIFE SAVING, OR LIFE SUSTAINING APPLICATIONS, NOR IN PRODUCTS OR SYSTEMS WHERE FAILURE OR MALFUNCTION MAY RESULT IN PERSONAL INJURY, DEATH, OR SEVERE PROPERTY OR ENVIRONMENTAL DAMAGE. ST PRODUCTS WHICH ARE NOT SPECIFIED AS "AUTOMOTIVE GRADE" MAY ONLY BE USED IN AUTOMOTIVE APPLICATIONS AT USER'S OWN RISK.

Resale of ST products with provisions different from the statements and/or technical features set forth in this document shall immediately void any warranty granted by ST for the ST product or service described herein and shall not create or extend in any manner whatsoever, any liability of ST.

ST and the ST logo are trademarks or registered trademarks of ST in various countries.

Information in this document supersedes and replaces all information previously supplied.

The ST logo is a registered trademark of STMicroelectronics. All other names are the property of their respective owners.

© 2012 STMicroelectronics - All rights reserved

STMicroelectronics group of companies

Australia - Belgium - Brazil - Canada - China - Czech Republic - Finland - France - Germany - Hong Kong - India - Israel - Italy - Japan - Malaysia - Malta - Morocco - Philippines - Singapore - Spain - Sweden - Switzerland - United Kingdom - United States of America

www.st.com

X-ON Electronics

Largest Supplier of Electrical and Electronic Components

Click to view similar products for [Switching Voltage Regulators](#) category:

Click to view products by [STMicroelectronics](#) manufacturer:

Other Similar products are found below :

[FAN53610AUC33X](#) [FAN53611AUC123X](#) [FAN48610BUC33X](#) [FAN48610BUC45X](#) [FAN48617UC50X](#) [R3](#) [430464BB](#) [KE177614](#)
[MAX809TTR](#) [NCV891234MW50R2G](#) [NCP81103MNTXG](#) [NCP81203PMNTXG](#) [NCP81208MNTXG](#) [NCP81109GMNTXG](#)
[SCY1751FCCT1G](#) [NCP81109JMNTXG](#) [AP3409ADNTR-G1](#) [NCP81241MNTXG](#) [LTM8064IY](#) [LT8315EFE#TRPBF](#) [LTM4668AIY#PBF](#)
[NCV1077CSTBT3G](#) [XCL207A123CR-G](#) [MPM54304GMN-0002](#) [MPM54304GMN-0004](#) [MPM54304GMN-0003](#)
[XDPE132G5CG000XUMA1](#) [MP8757GL-P](#) [MP9943AGQ-P](#) [MIC23356YFT-TR](#) [LD8116CGL](#) [HG2269M/TR](#) [OB2269](#) [XD3526](#) [U6215A](#)
[U6215B](#) [U6620S](#) [LTC3412IFE](#) [LT1425IS](#) [MAX25203BATJA/VY+](#) [MAX77874CEWM+](#) [XC9236D08CER-G](#) [ISL95338IRTZ](#) [MP3416GJ-P](#)
[BD9S201NUX-CE2](#) [MP5461GC-Z](#) [MPQ4415AGQB-Z](#) [MPQ4590GS-Z](#) [MAX38640BENT18+T](#) [MAX77511AEWB+](#)