



# STB12NM50ND STD12NM50ND, STF12NM50ND

N-channel 500 V, 0.29  $\Omega$ , 11 A, FDmesh™ II Power MOSFET  
(with fast diode) in D<sup>2</sup>PAK, DPAK, TO-220FP

## Features

Type	V <sub>DSS</sub> (@T <sub>jmax</sub> )	R <sub>DS(on)</sub> max	I <sub>D</sub>
STB12NM50ND	550 V	0.38 $\Omega$	11 A
STD12NM50ND	550 V	0.38 $\Omega$	11 A
STF12NM50ND	550 V	0.38 $\Omega$	11 A

- 100% avalanche tested
- Low input capacitance and gate charge
- Low gate input resistance

## Application

- Switching applications

## Description

FDmesh™ technology combines the MDmesh™ features with an intrinsic fast-recovery body diode. The resulting product has reduced on-resistance and fast switching commutations, making it especially suitable for bridge topologies where low  $t_{rr}$  is required.

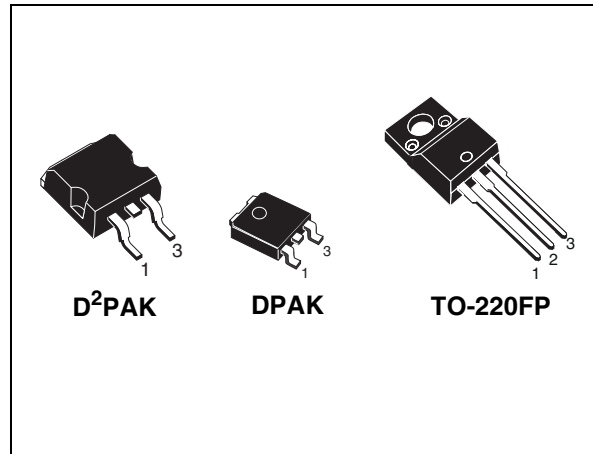

Figure 1. Internal schematic diagram

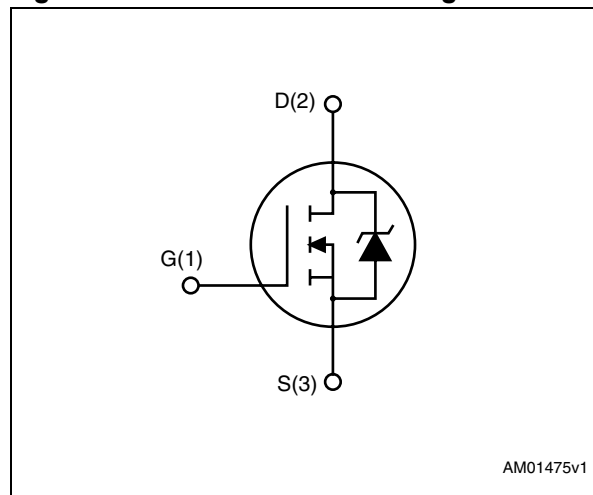

Table 1. Device summary

Order codes	Marking	Package	Packaging
STB12NM50ND	12NM50ND	D <sup>2</sup> PAK	Tape and reel
STD12NM50ND	12NM50ND	DPAK	Tape and reel
STF12NM50ND	12NM50ND	TO-220FP	Tube

# Contents

<b>1</b>	<b>Electrical ratings</b> .....	<b>3</b>
<b>2</b>	<b>Electrical characteristics</b> .....	<b>4</b>
2.1	Electrical characteristics (curves) .....	6
<b>3</b>	<b>Test circuits</b> .....	<b>9</b>
<b>4</b>	<b>Package mechanical data</b> .....	<b>10</b>
<b>5</b>	<b>Packaging mechanical data</b> .....	<b>13</b>
<b>6</b>	<b>Revision history</b> .....	<b>15</b>

# 1 Electrical ratings

**Table 2. Absolute maximum ratings**

Symbol	Parameter	Value			Unit
		D <sup>2</sup> PAK	DPAK	TO-220FP	
V <sub>DS</sub>	Drain-source voltage (V <sub>GS</sub> =0)	500			V
V <sub>GS</sub>	Gate-source voltage	± 25			V
I <sub>D</sub>	Drain current (continuous) at T <sub>C</sub> = 25 °C	11		11 <sup>(1)</sup>	A
I <sub>D</sub>	Drain current (continuous) at T <sub>C</sub> = 100 °C	6.9		6.9 <sup>(1)</sup>	A
I <sub>DM</sub> <sup>(2)</sup>	Drain current (pulsed)	44		44 <sup>(1)</sup>	A
P <sub>TOT</sub>	Total dissipation at T <sub>C</sub> = 25 °C	100		25	W
V <sub>ISO</sub>	Insulation withstand voltage (RMS) from all three leads to external heat sink (t=1 s; T <sub>C</sub> =25 °C)			2500	V
dv/dt <sup>(3)</sup>	Peak diode recovery voltage slope	40			V/ns
T <sub>stg</sub>	Storage temperature	-55 to 150			°C
T <sub>j</sub>	Operating junction temperature	150			°C

- Limited only by maximum temperature allowed
- Pulse width limited by safe operating area
- I<sub>SD</sub> ≤ 11 A, di/dt ≤ 600 A/μs, V<sub>DD</sub> = 80% V<sub>(BR)DSS</sub>

**Table 3. Thermal data**

Symbol	Parameter	Value			Unit
		D <sup>2</sup> PAK	DPAK	TO-220FP	
R <sub>thj-case</sub>	Thermal resistance junction-case max	1.25		5	°C/W
R <sub>thj-pcb</sub>	Thermal resistance junction-pcb max	30	50		°C/W
R <sub>thj-amb</sub>	Thermal resistance junction-amb max			62.5	°C/W
T <sub>l</sub>	Maximum lead temperature for soldering purposes	300			°C

**Table 4. Avalanche characteristics**

Symbol	Parameter	Max value	Unit
I <sub>AS</sub>	Avalanche current, repetitive or not-repetitive (pulse width limited by T <sub>j</sub> max)	5	A
E <sub>AS</sub>	Single pulse avalanche energy (starting T <sub>j</sub> = 25 °C, I <sub>D</sub> = I <sub>AS</sub> , V <sub>DD</sub> = 50 V)	350	mJ

## 2 Electrical characteristics

( $T_{CASE} = 25\text{ °C}$  unless otherwise specified)

**Table 5. On/off states**

Symbol	Parameter	Test conditions	Min.	Typ.	Max.	Unit
$V_{(BR)DSS}$	Drain-source breakdown voltage	$I_D = 1\text{ mA}$ , $V_{GS} = 0$	500			V
$dv/dt^{(1)}$	Drain-source voltage slope	$V_{DD} = 400\text{ V}$ , $I_D = 11\text{ A}$ , $V_{GS} = 10\text{ V}$	44			V/ns
$I_{DSS}$	Zero gate voltage drain current ( $V_{GS} = 0$ )	$V_{DS} = \text{Max rating}$ , $V_{DS} = \text{Max rating}$ , @ $125\text{ °C}$			1 100	$\mu\text{A}$ $\mu\text{A}$
$I_{GSS}$	Gate body leakage current ( $V_{DS} = 0$ )	$V_{GS} = \pm 20\text{ V}$			100	nA
$V_{GS(th)}$	Gate threshold voltage	$V_{DS} = V_{GS}$ , $I_D = 250\text{ }\mu\text{A}$	3	4	5	V
$R_{DS(on)}$	Static drain-source on resistance	$V_{GS} = 10\text{ V}$ , $I_D = 5.5\text{ A}$		0.29	0.38	$\Omega$

1. Value measured at turn off under inductive load

**Table 6. Dynamic**

Symbol	Parameter	Test conditions	Min.	Typ.	Max.	Unit
$g_{fs}^{(1)}$	Forward transconductance	$V_{DS} = 15\text{ V}$ , $I_D = 5.5\text{ A}$	-	8	-	S
$C_{iss}$ $C_{oss}$ $C_{rss}$	Input capacitance Output capacitance Reverse transfer capacitance	$V_{DS} = 50\text{ V}$ , $f = 1\text{ MHz}$ , $V_{GS} = 0$	-	850 48 5	-	pF pF pF
$C_{oss\text{ eq.}}^{(2)}$	Equivalent output capacitance	$V_{GS} = 0$ , $V_{DS} = 0\text{ to }400\text{ V}$	-	100	-	pF
$R_g$	Gate input resistance	$f = 1\text{ MHz}$ Gate DC Bias = 0 Test signal level = 20 mV open drain	-	4.5	-	$\Omega$
$Q_g$ $Q_{gs}$ $Q_{gd}$	Total gate charge Gate-source charge Gate-drain charge	$V_{DD} = 400\text{ V}$ , $I_D = 11\text{ A}$ $V_{GS} = 10\text{ V}$ <i>Figure 19</i>	-	30 6 17	-	nC nC nC

1. Pulsed: pulse duration = 300  $\mu\text{s}$ , duty cycle 1.5%

2.  $C_{oss\text{ eq.}}$  is defined as a constant equivalent capacitance giving the same charging time as  $C_{oss}$  when  $V_{DS}$  increases from 0 to 80%  $V_{DSS}$

Table 7. Switching times

Symbol	Parameter	Test conditions	Min.	Typ.	Max.	Unit
$t_{d(on)}$	Turn-on delay time	$V_{DD} = 250\text{ V}$ , $I_D = 5.5\text{ A}$ , $R_G = 4.7\ \Omega$ , $V_{GS} = 10\text{ V}$ <i>Figure 18</i>	-	12	-	ns
$t_r$	Rise time		-	15	-	ns
$t_{d(off)}$	Turn-off delay time		-	40	-	ns
$t_f$	Fall time		-	17	-	ns

Table 8. Source drain diode

Symbol	Parameter	Test conditions	Min.	Typ.	Max.	Unit
$I_{SD}$	Source-drain current		-		11	A
$I_{SDM}^{(1)}$	Source-drain current (pulsed)		-		44	A
$V_{SD}^{(2)}$	Forward on voltage	$I_{SD} = 11\text{ A}$ , $V_{GS} = 0$	-		1.6	V
$t_{rr}$	Reverse recovery time	$I_{SD} = 11\text{ A}$ , $di/dt = 100\text{ A}/\mu\text{s}$ , $V_{DD} = 100\text{ V}$ <i>Figure 20</i>	-	122		ns
$Q_{rr}$	Reverse recovery charge		-	650		nC
$I_{RRM}$	Reverse recovery current		-	11		A
$t_{rr}$	Reverse recovery time	$V_{DD} = 100\text{ V}$ $di/dt = 100\text{ A}/\mu\text{s}$ , $I_{SD} = 11\text{ A}$ $T_j = 150\text{ }^\circ\text{C}$ , <i>Figure 20</i>	-	160		ns
$Q_{rr}$	Reverse recovery charge		-	940		nC
$I_{RRM}$	Reverse recovery current		-	12		A

1. Pulse width limited by safe operating area

2. Pulsed: pulse duration = 300  $\mu\text{s}$ , duty cycle 1.5%

## 2.1 Electrical characteristics (curves)

Figure 2. Safe operating area for D<sup>2</sup>PAK

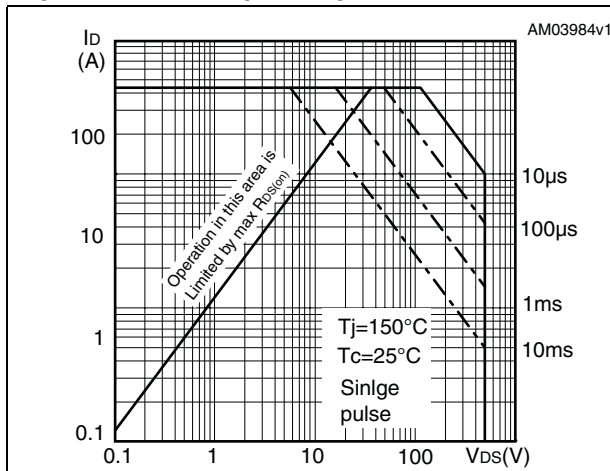

Figure 3. Thermal impedance for D<sup>2</sup>PAK

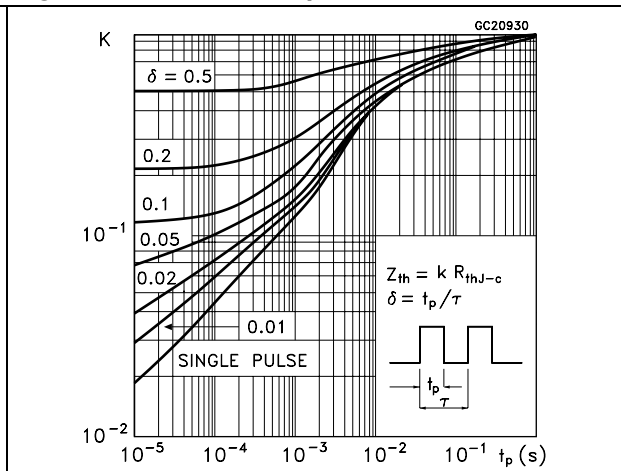

Figure 4. Safe operating area for TO-220FP

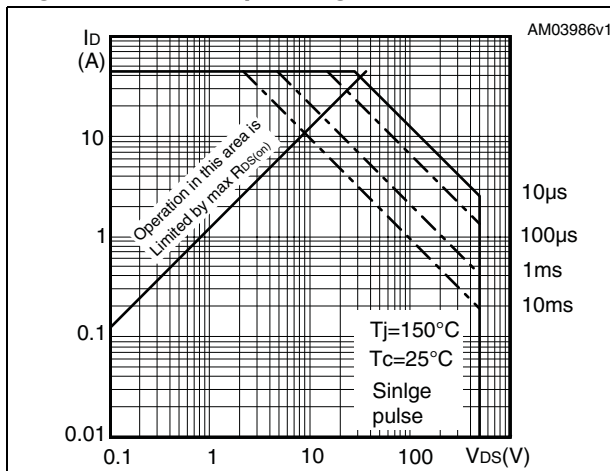

Figure 5. Thermal impedance for TO-220FP

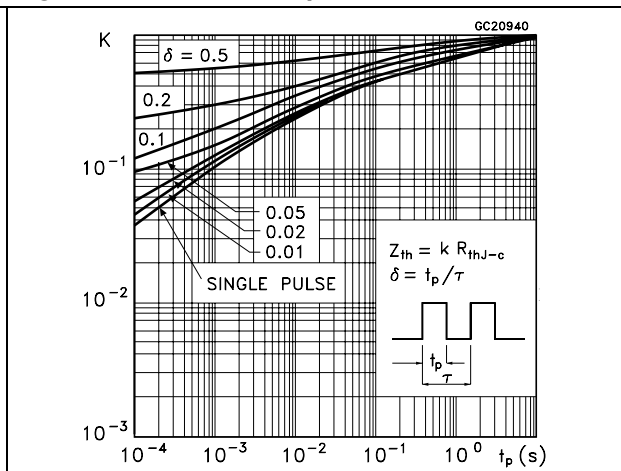

Figure 6. Safe operating area for DPAK

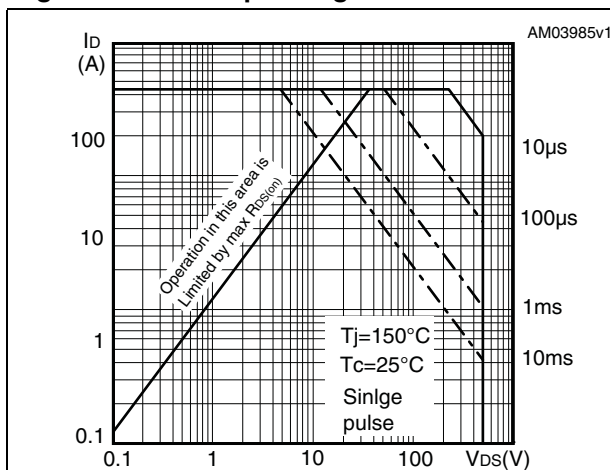

Figure 7. Thermal impedance for DPAK

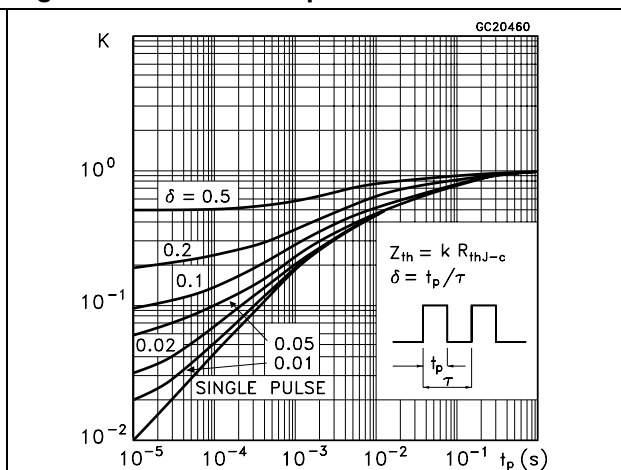

Figure 8. Output characteristics

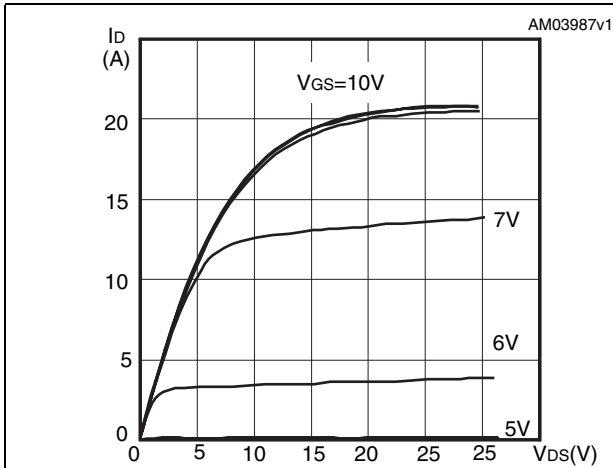

Figure 9. Transfer characteristics

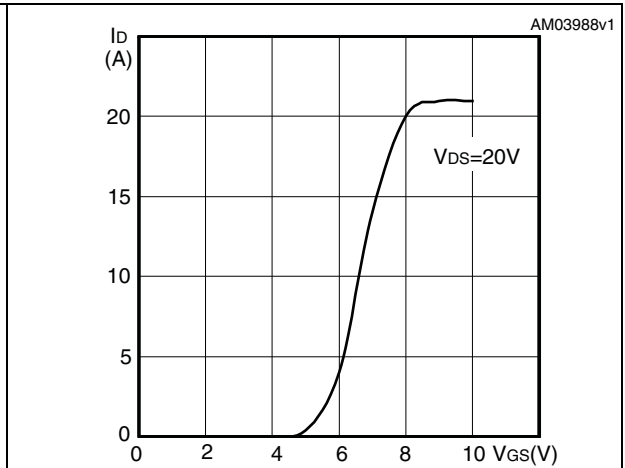

Figure 10. Transconductance

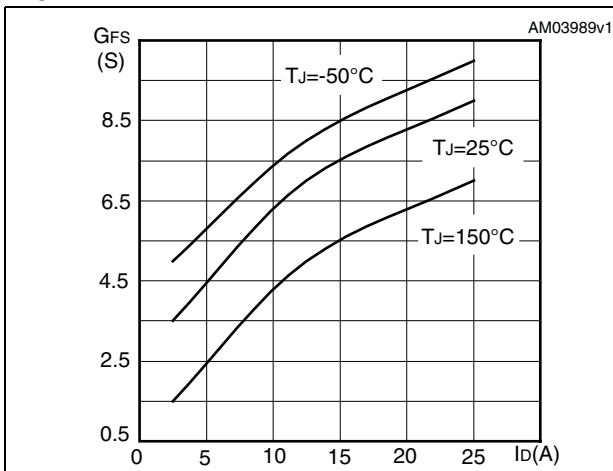

Figure 11. Static drain-source on resistance

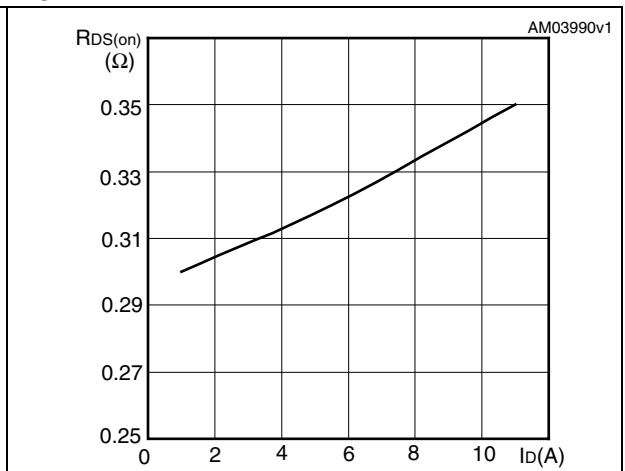

Figure 12. Gate charge vs gate-source voltage

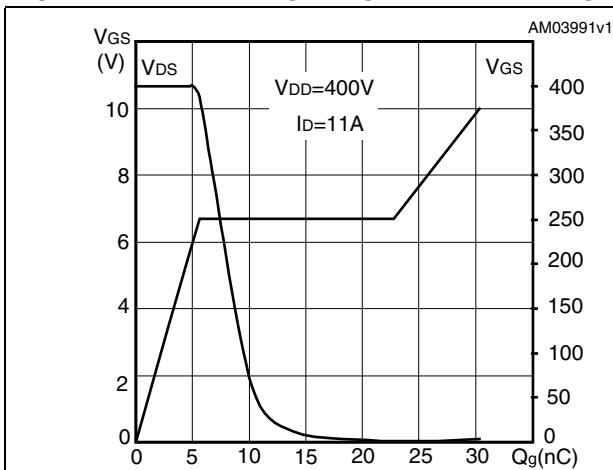

Figure 13. Capacitance variations

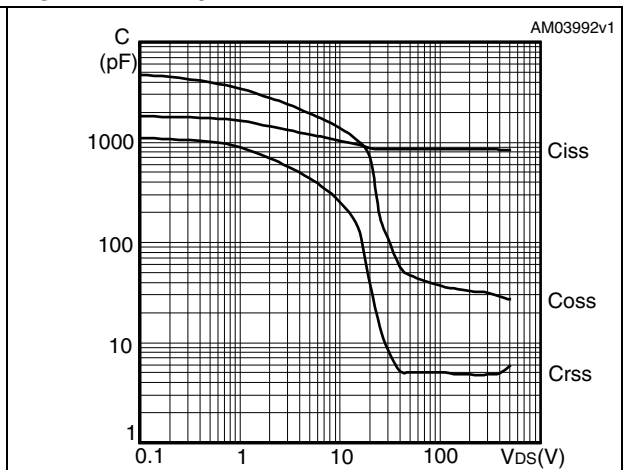

Figure 14. Normalized gate threshold voltage vs temperature

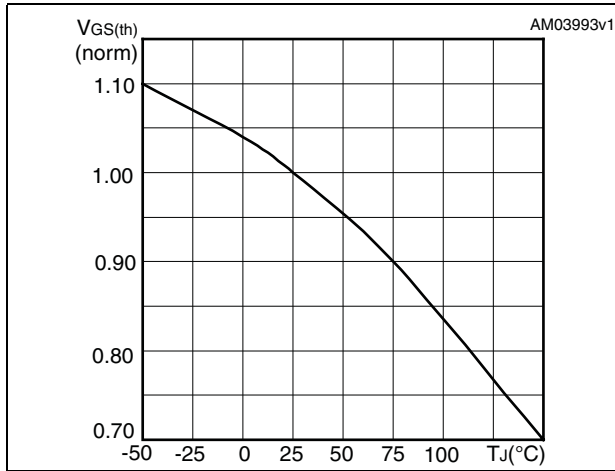

Figure 15. Normalized on resistance vs temperature

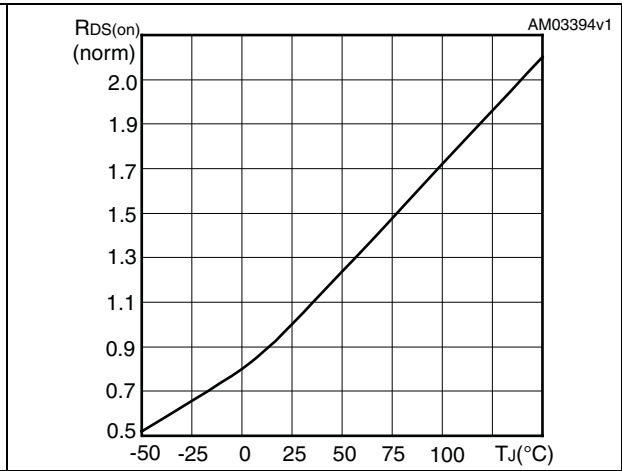

Figure 16. Source-drain diode forward characteristics

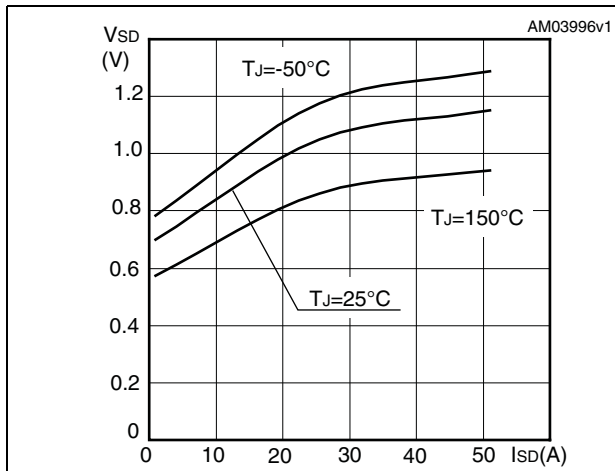
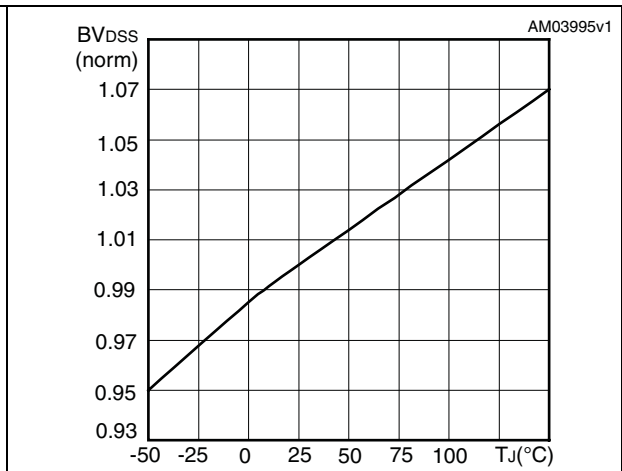

Figure 17. Normalized BV<sub>DSS</sub> vs temperature





### 3 Test circuits

**Figure 18. Switching times test circuit for resistive load**

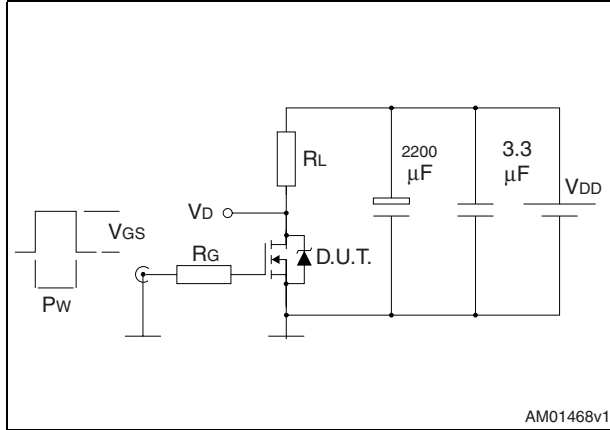

**Figure 19. Gate charge test circuit**

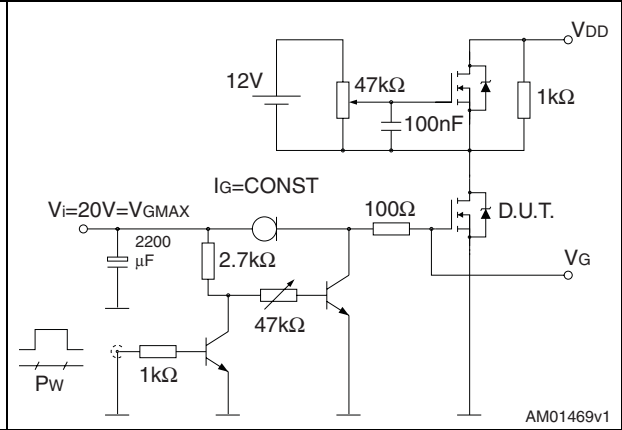

**Figure 20. Test circuit for inductive load switching and diode recovery times**

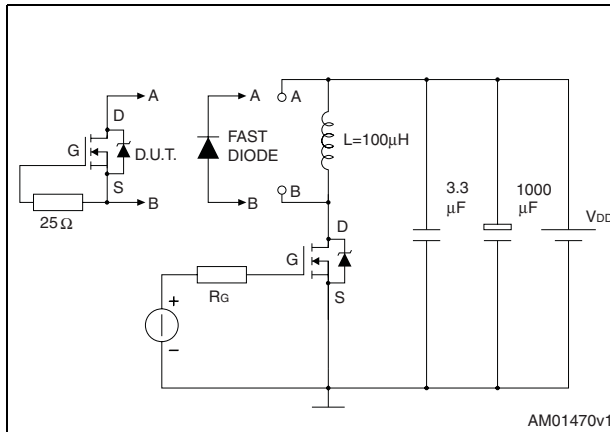

**Figure 21. Unclamped inductive load test circuit**

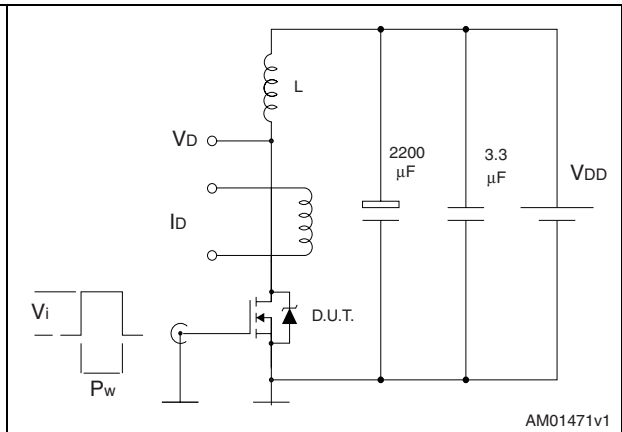

**Figure 22. Unclamped inductive waveform**

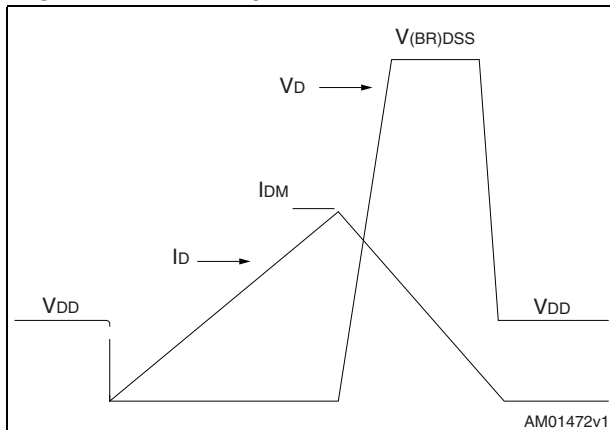

**Figure 23. Switching time waveform**

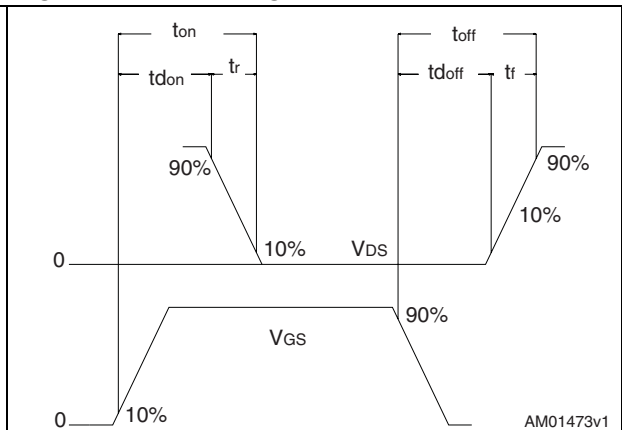

## 4 Package mechanical data

In order to meet environmental requirements, ST offers these devices in different grades of ECOPACK<sup>®</sup> packages, depending on their level of environmental compliance. ECOPACK<sup>®</sup> specifications, grade definitions and product status are available at: [www.st.com](http://www.st.com). ECOPACK is an ST trademark.

TO-252 (DPAK) mechanical data

DIM.	mm.		
	min.	typ	max.
A	2.20		2.40
A1	0.90		1.10
A2	0.03		0.23
b	0.64		0.90
b4	5.20		5.40
c	0.45		0.60
c2	0.48		0.60
D	6.00		6.20
D1		5.10	
E	6.40		6.60
E1		4.70	
e		2.28	
e1	4.40		4.60
H	9.35		10.10
L	1		
L1		2.80	
L2		0.80	
L4	0.60		1
R		0.20	
V2	0°		8°

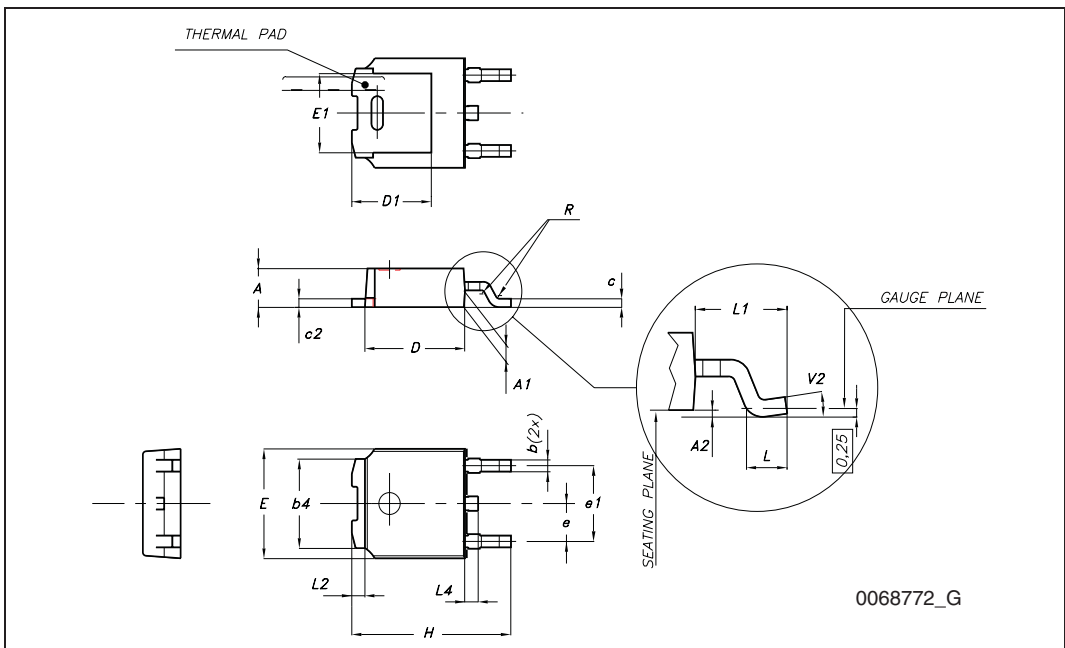

D<sup>2</sup>PAK (TO-263) mechanical data

Dim	mm			inch		
	Min	Typ	Max	Min	Typ	Max
A	4.40		4.60	0.173		0.181
A1	0.03		0.23	0.001		0.009
b	0.70		0.93	0.027		0.037
b2	1.14		1.70	0.045		0.067
c	0.45		0.60	0.017		0.024
c2	1.23		1.36	0.048		0.053
D	8.95		9.35	0.352		0.368
D1	7.50			0.295		
E	10		10.40	0.394		0.409
E1	8.50			0.334		
e		2.54			0.1	
e1	4.88		5.28	0.192		0.208
H	15		15.85	0.590		0.624
J1	2.49		2.69	0.099		0.106
L	2.29		2.79	0.090		0.110
L1	1.27		1.40	0.05		0.055
L2	1.30		1.75	0.051		0.069
R		0.4			0.016	
V2	0°		8°	0°		8°

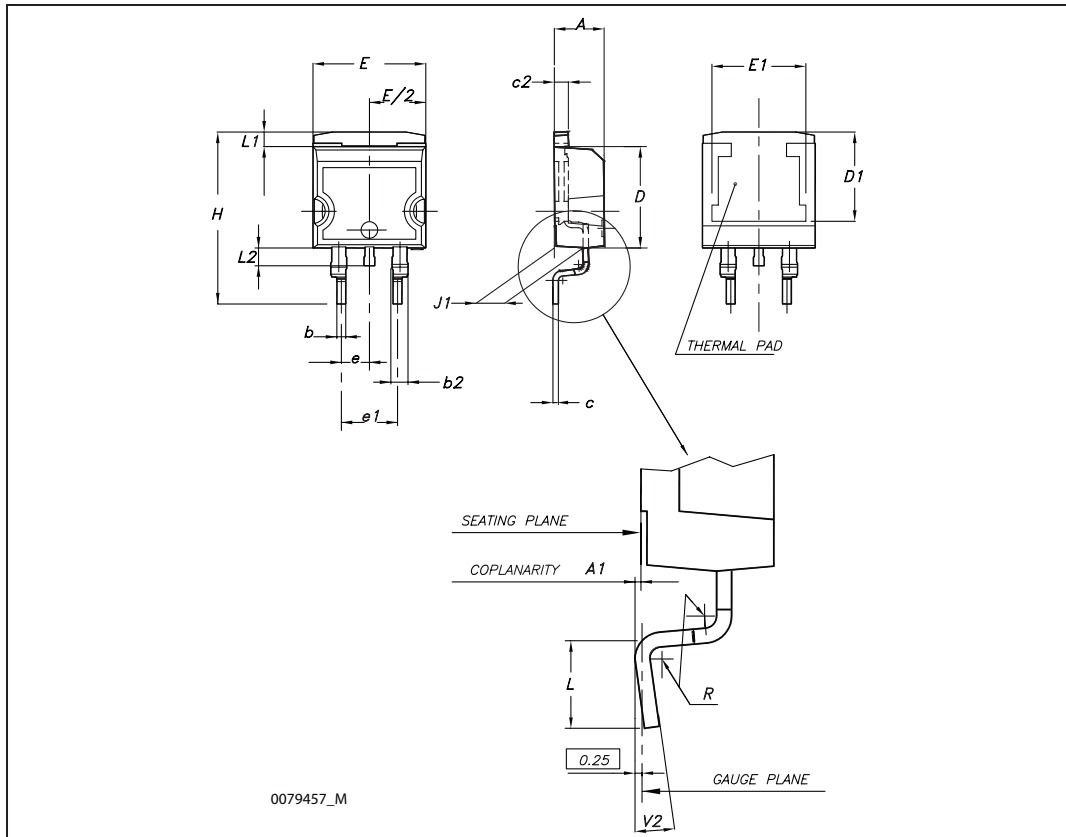

# 5 Packaging mechanical data

## D<sup>2</sup>PAK FOOTPRINT

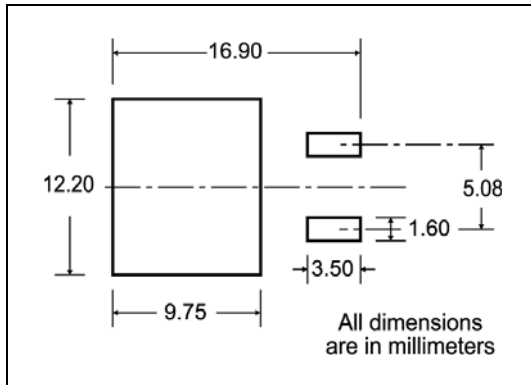

## TAPE AND REEL SHIPMENT

**TAPE MECHANICAL DATA**

DIM.	mm		inch	
	MIN.	MAX.	MIN.	MAX.
A0	10.5	10.7	0.413	0.421
B0	15.7	15.9	0.618	0.626
D	1.5	1.6	0.059	0.063
D1	1.59	1.61	0.062	0.063
E	1.65	1.85	0.065	0.073
F	11.4	11.6	0.449	0.456
K0	4.8	5.0	0.189	0.197
P0	3.9	4.1	0.153	0.161
P1	11.9	12.1	0.468	0.476
P2	1.9	2.1	0.075	0.082
R	50		1.574	
T	0.25	0.35	0.0098	0.0137
W	23.7	24.3	0.933	0.956

**REEL MECHANICAL DATA**

DIM.	mm		inch	
	MIN.	MAX.	MIN.	MAX.
A		330		12.992
B	1.5		0.059	
C	12.8	13.2	0.504	0.520
D	20.2		0.795	
G	24.4	26.4	0.960	1.039
N	100		3.937	
T		30.4		1.197

BASE QTY	BULK QTY
1000	1000

\* on sales type

**DPAK FOOTPRINT**

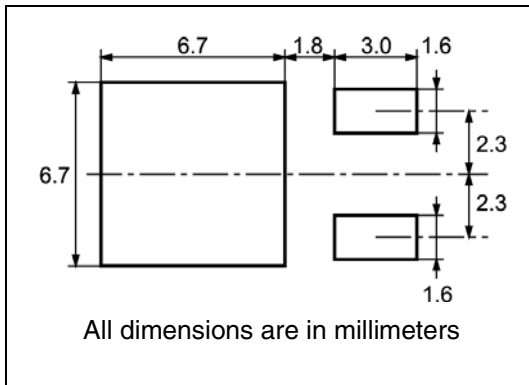

**TAPE AND REEL SHIPMENT**

40 mm min. Access hole at slot location

Full radius

Tape slot in core for tape start 2.5mm min. width

G measured at hub

**REEL MECHANICAL DATA**

DIM.	mm		inch	
	MIN.	MAX.	MIN.	MAX.
A		330		12.992
B	1.5		0.059	
C	12.8	13.2	0.504	0.520
D	20.2		0.795	
G	16.4	18.4	0.645	0.724
N	50		1.968	
T		22.4		0.881

**TAPE MECHANICAL DATA**

DIM.	mm		inch	
	MIN.	MAX.	MIN.	MAX.
A0	6.8	7	0.267	0.275
B0	10.4	10.6	0.409	0.417
B1		12.1		0.476
D	1.5	1.6	0.059	0.063
D1	1.5		0.059	
E	1.65	1.85	0.065	0.073
F	7.4	7.6	0.291	0.299
K0	2.55	2.75	0.100	0.108
P0	3.9	4.1	0.153	0.161
P1	7.9	8.1	0.311	0.319
P2	1.9	2.1	0.075	0.082
R	40		1.574	
W	15.7	16.3	0.618	0.641

**BASE QTY**      **BULK QTY**

2500	2500
------	------

TOP COVER TAPE

User Direction of Feed

Center line of cavity

Bending radius

FEED DIRECTION

10 pitches cumulative tolerance on tape +/- 0.2 mm

For machine ref. only including draft and radii concentric around B0

## 6 Revision history

**Table 9. Document revision history**

<b>Date</b>	<b>Revision</b>	<b>Changes</b>
23-Sep-2008	1	First release
10-Jun-2009	2	Added new package, mechanical data: TO-220FP

**Please Read Carefully:**

Information in this document is provided solely in connection with ST products. STMicroelectronics NV and its subsidiaries ("ST") reserve the right to make changes, corrections, modifications or improvements, to this document, and the products and services described herein at any time, without notice.

All ST products are sold pursuant to ST's terms and conditions of sale.

Purchasers are solely responsible for the choice, selection and use of the ST products and services described herein, and ST assumes no liability whatsoever relating to the choice, selection or use of the ST products and services described herein.

No license, express or implied, by estoppel or otherwise, to any intellectual property rights is granted under this document. If any part of this document refers to any third party products or services it shall not be deemed a license grant by ST for the use of such third party products or services, or any intellectual property contained therein or considered as a warranty covering the use in any manner whatsoever of such third party products or services or any intellectual property contained therein.

**UNLESS OTHERWISE SET FORTH IN ST'S TERMS AND CONDITIONS OF SALE ST DISCLAIMS ANY EXPRESS OR IMPLIED WARRANTY WITH RESPECT TO THE USE AND/OR SALE OF ST PRODUCTS INCLUDING WITHOUT LIMITATION IMPLIED WARRANTIES OF MERCHANTABILITY, FITNESS FOR A PARTICULAR PURPOSE (AND THEIR EQUIVALENTS UNDER THE LAWS OF ANY JURISDICTION), OR INFRINGEMENT OF ANY PATENT, COPYRIGHT OR OTHER INTELLECTUAL PROPERTY RIGHT.**

**UNLESS EXPRESSLY APPROVED IN WRITING BY AN AUTHORIZED ST REPRESENTATIVE, ST PRODUCTS ARE NOT RECOMMENDED, AUTHORIZED OR WARRANTED FOR USE IN MILITARY, AIR CRAFT, SPACE, LIFE SAVING, OR LIFE SUSTAINING APPLICATIONS, NOR IN PRODUCTS OR SYSTEMS WHERE FAILURE OR MALFUNCTION MAY RESULT IN PERSONAL INJURY, DEATH, OR SEVERE PROPERTY OR ENVIRONMENTAL DAMAGE. ST PRODUCTS WHICH ARE NOT SPECIFIED AS "AUTOMOTIVE GRADE" MAY ONLY BE USED IN AUTOMOTIVE APPLICATIONS AT USER'S OWN RISK.**

Resale of ST products with provisions different from the statements and/or technical features set forth in this document shall immediately void any warranty granted by ST for the ST product or service described herein and shall not create or extend in any manner whatsoever, any liability of ST.

ST and the ST logo are trademarks or registered trademarks of ST in various countries.

Information in this document supersedes and replaces all information previously supplied.

The ST logo is a registered trademark of STMicroelectronics. All other names are the property of their respective owners.

© 2009 STMicroelectronics - All rights reserved

STMicroelectronics group of companies

Australia - Belgium - Brazil - Canada - China - Czech Republic - Finland - France - Germany - Hong Kong - India - Israel - Italy - Japan - Malaysia - Malta - Morocco - Philippines - Singapore - Spain - Sweden - Switzerland - United Kingdom - United States of America

[www.st.com](http://www.st.com)



## X-ON Electronics

Largest Supplier of Electrical and Electronic Components

*Click to view similar products for [MOSFET](#) category:*

*Click to view products by [STMicroelectronics](#) manufacturer:*

Other Similar products are found below :

[614233C](#) [648584F](#) [IRFD120](#) [JANTX2N5237](#) [2N7000](#) [FCA20N60\\_F109](#) [FDZ595PZ](#) [2SK2545\(Q,T\)](#) [405094E](#) [423220D](#)  
[TPCC8103,L1Q\(CM](#) [MIC4420CM-TR](#) [VN1206L](#) [614234A](#) [715780A](#) [NTNS3166NZT5G](#) [SSM6J414TU,LF\(T](#) [751625C](#)  
[IPS70R2K0CEAKMA1](#) [BUK954R8-60E](#) [DMN3404LQ-7](#) [NTE6400](#) [SQJ402EP-T1-GE3](#) [2SK2614\(TE16L1,Q\)](#) [2N7002KW-FAI](#)  
[DMN1017UCP3-7](#) [EFC2J004NUZTDG](#) [ECH8691-TL-W](#) [FCAB21350L1](#) [P85W28HP2F-7071](#) [DMN1053UCP4-7](#) [NTE221](#) [NTE2384](#)  
[NTE2903](#) [NTE2941](#) [NTE2945](#) [NTE2946](#) [NTE2960](#) [NTE2967](#) [NTE2969](#) [NTE2976](#) [NTE455](#) [NTE6400A](#) [NTE2910](#) [NTE2916](#) [NTE2956](#)  
[NTE2911](#) [TK10A80W,S4X\(S](#) [SSM6P69NU,LF](#) [DMP22D4UFO-7B](#)