

## N-channel 600 V, 0.45 $\Omega$ typ., 13.5 A SuperMESH™ Power MOSFETs in D<sup>2</sup>PAK and TO-220FP packages

Datasheet - production data

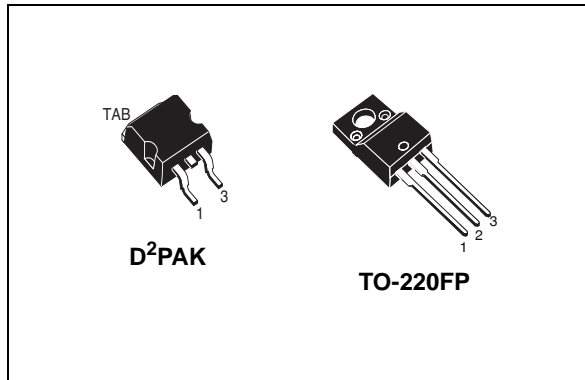
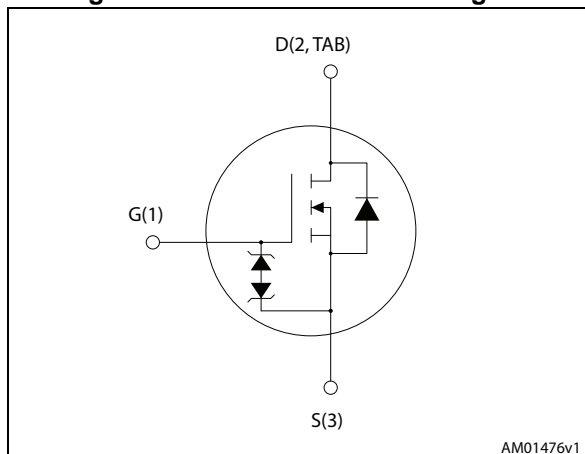

Figure 1. Internal schematic diagram



### Features

Order codes	V <sub>DS</sub>	R <sub>DS(on)</sub> max.	I <sub>D</sub>	P <sub>TOT</sub>
STB14NK60ZT4	600 V	0.5 $\Omega$	13.5 A	160 W
STP14NK60ZFP				40 W

- Extremely high dv/dt capability
- 100% avalanche tested
- Gate charge minimized
- Very low intrinsic capacitances
- Very good manufacturing repeatability
- Zener-protected

### Applications

- Switching applications

### Description

These devices are N-channel Zener-protected Power MOSFETs developed using STMicroelectronics' SuperMESH™ technology, achieved through optimization of ST's well established strip-based PowerMESH™ layout. In addition to a significant reduction in on-resistance, this device is designed to ensure a high level of dv/dt capability for the most demanding applications.

Table 1. Device summary

Order codes	Marking	Package	Packaging
STB14NK60ZT4	B14NK60Z	D <sup>2</sup> PAK	Tape and reel
STP14NK60ZFP	P14NK60ZFP	TO-220FP	Tube

## Contents

<b>1</b>	<b>Electrical ratings</b> .....	<b>3</b>
<b>2</b>	<b>Electrical characteristics</b> .....	<b>4</b>
	2.1 Electrical characteristics (curves) .....	6
<b>3</b>	<b>Test circuits</b> .....	<b>9</b>
<b>4</b>	<b>Package mechanical data</b> .....	<b>10</b>
	4.1 D <sup>2</sup> PAK, STB14NK60ZT4 .....	11
	4.2 TO-220FP, STP14NK60ZFP .....	14
<b>5</b>	<b>Packaging mechanical data</b> .....	<b>16</b>
<b>6</b>	<b>Revision history</b> .....	<b>18</b>

# 1 Electrical ratings

**Table 2. Absolute maximum ratings**

Symbol	Parameter	Value		Unit
		D <sup>2</sup> PAK	TO-220FP	
V <sub>DS</sub>	Drain-source voltage	600		V
V <sub>DGR</sub>	Drain-gate voltage (R <sub>GS</sub> = 20 kΩ)	600		V
V <sub>GS</sub>	Gate-source voltage	± 30		V
I <sub>D</sub>	Drain current (continuous) at T <sub>C</sub> = 25°C	13.5	13.5 <sup>(1)</sup>	A
I <sub>D</sub>	Drain current (continuous) at T <sub>C</sub> =100°C	8.5	8.5 <sup>(1)</sup>	A
I <sub>DM</sub> <sup>(2)</sup>	Drain current (pulsed)	54	54 <sup>(1)</sup>	A
P <sub>TOT</sub>	Total dissipation at T <sub>C</sub> = 25°C	160	40	W
	Derating factor	1.28	0.32	W/°C
ESD	Gate-source human body model (R= 1.5 kΩ, C= 100pF)	4		kV
dv/dt <sup>(3)</sup>	Peak diode recovery voltage slope	4.5		V/ns
V <sub>ISO</sub>	Insulation withstand voltage (RMS) from all three leads to external heat sink (t = 1 s, T <sub>C</sub> = 25 °C)		2500	V
T <sub>J</sub> T <sub>stg</sub>	Operating junction temperature Storage temperature	-55 to 150		°C

- Limited by maximum junction temperature
- Pulse width limited by safe operating area
- I<sub>SD</sub> ≤ 13.5A, di/dt ≤ 200A/μs, V<sub>DD</sub> ≤ V<sub>(BR)DSS</sub>, T<sub>J</sub> ≤ T<sub>JMAX</sub>.

**Table 3. Thermal data**

Symbol	Parameter	Value		Unit
		D <sup>2</sup> PAK	TO-220FP	
R <sub>thj-case</sub>	Thermal resistance junction-case max	0.78	3.1	°C/W
R <sub>thj-amb</sub>	Thermal resistance junction-ambient max	62.5	62.5	°C/W

**Table 4. Avalanche characteristics**

Symbol	Parameter	Value	Unit
I <sub>AS</sub>	Avalanche current, repetitive or not-repetitive (pulse width limited by T <sub>Jmax</sub> )	12	A
E <sub>AS</sub>	Single pulse avalanche energy (starting T <sub>J</sub> =25°C, I <sub>D</sub> =I <sub>AR</sub> , V <sub>dd</sub> =50 V)	300	mJ

## 2 Electrical characteristics

( $T_{CASE}=25^{\circ}C$  unless otherwise specified)

**Table 5. On/off states**

Symbol	Parameter	Test conditions	Min.	Typ.	Max.	Unit
$V_{(BR)DSS}$	Drain-source breakdown voltage	$I_D = 1 \text{ mA}, V_{GS} = 0$	600			V
$I_{DSS}$	Zero gate voltage drain current ( $V_{GS} = 0$ )	$V_{DS} = 600 \text{ V}$			1	$\mu\text{A}$
		$V_{DS} = 600 \text{ V}, T_C = 125^{\circ}C$			50	$\mu\text{A}$
$I_{GSS}$	Gate body leakage current ( $V_{DS} = 0$ )	$V_{GS} = \pm 30 \text{ V}$			$\pm 10$	$\mu\text{A}$
$V_{GS(th)}$	Gate threshold voltage	$V_{DS} = V_{GS}, I_D = 100 \mu\text{A}$	3	3.75	4.5	V
$R_{DS(on)}$	Static drain-source on resistance	$V_{GS} = 10 \text{ V}, I_D = 6 \text{ A}$		0.45	0.5	$\Omega$

**Table 6. Dynamic**

Symbol	Parameter	Test conditions	Min.	Typ.	Max.	Unit
$C_{iss}$	Input capacitance	$V_{DS} = 25\text{V}, f = 1 \text{ MHz}, V_{GS} = 0$	-	2220	-	pF
$C_{oss}$	Output capacitance		-	240	-	pF
$C_{rss}$	Reverse transfer capacitance		-	57	-	pF
$C_{oss \text{ eq}}^{(1)}$	Equivalent output capacitance	$V_{GS} = 0, V_{DS} = 0 \text{ V to } 480 \text{ V}$	-	122	-	pF
$Q_g$	Total gate charge	$V_{DD} = 480 \text{ V}, I_D = 12 \text{ A}, V_{GS} = 10 \text{ V}$	-	75	-	nC
$Q_{gs}$	Gate-source charge		-	13.2	-	nC
$Q_{gd}$	Gate-drain charge		-	38.6	-	nC

1.  $C_{oss \text{ eq}}^{(1)}$  is defined as a constant equivalent capacitance giving the same charging time as  $C_{oss}$  when  $V_{DS}$  increases from 0 to 80%  $V_{DSS}$

Table 7. Switching times

Symbol	Parameter	Test conditions	Min.	Typ.	Max.	Unit
$t_{d(on)}$	Turn-on delay time	$V_{DD}=300\text{ V}$ , $I_D=6\text{ A}$ , $R_G=4.7\ \Omega$ , $V_{GS}=10\text{ V}$ (see Figure 17)	-	26	-	ns
$t_r$	Rise time		-	18	-	ns
$t_{d(off)}$	Turn-off delay time		-	62	-	ns
$t_f$	Fall time		-	13	-	ns
$t_{r(Voff)}$	Off-voltage rise time	$V_{DD}=480\text{ V}$ , $I_D=12\text{ A}$ , $R_G=4.7\ \Omega$ , $V_{GS}=10\text{ V}$ (see Figure 19)	-	12	-	ns
$t_f$	Fall time		-	9.5	-	ns
$t_c$	Cross-over time		-	22	-	ns

Table 8. Source drain diode

Symbol	Parameter	Test conditions	Min	Typ.	Max	Unit
$I_{SD}$	Source-drain current		-		12	A
$I_{SDM}^{(1)}$	Source-drain current (pulsed)		-		48	A
$V_{SD}^{(2)}$	Forward on voltage	$I_{SD}=12\text{ A}$ , $V_{GS}=0$	-		1.6	V
$t_{rr}$	Reverse recovery time	$I_{SD}=12\text{ A}$ , $di/dt = 100\text{ A}/\mu\text{s}$ , $V_{DD}=50\text{ V}$	-	490		ns
$Q_{rr}$	Reverse recovery charge		-	4.7		$\mu\text{C}$
$I_{RRM}$	Reverse recovery current		-	19.3		A
$t_{rr}$	Reverse recovery time	$I_{SD}=12\text{ A}$ , $di/dt = 100\text{ A}/\mu\text{s}$ , $V_{DD}=50\text{ V}$ , $T_j=150\text{ }^\circ\text{C}$	-	664		ns
$Q_{rr}$	Reverse recovery charge		-	6.8		$\mu\text{C}$
$I_{RRM}$	Reverse recovery current		-	20.5		A

1. Pulse width limited by safe operating area

2. Pulsed: pulse duration=300 $\mu\text{s}$ , duty cycle 1.5%

Table 9. Gate-source Zener diode

Symbol	Parameter	Test conditions	Min	Typ.	Max.	Unit
$V_{(BR)GSO}$	Gate-source breakdown voltage	$I_{GS} = \pm 1\text{ mA}$ , $I_D=0$	30	-	-	V

The built-in back-to-back Zener diodes have specifically been designed to enhance the device's ESD capability. In this respect the Zener voltage is appropriate to achieve an efficient and cost-effective intervention to protect the device's integrity. These integrated Zener diodes thus avoid the usage of external components.

## 2.1 Electrical characteristics (curves)

Figure 2. Safe operating area for D<sup>2</sup>PAK

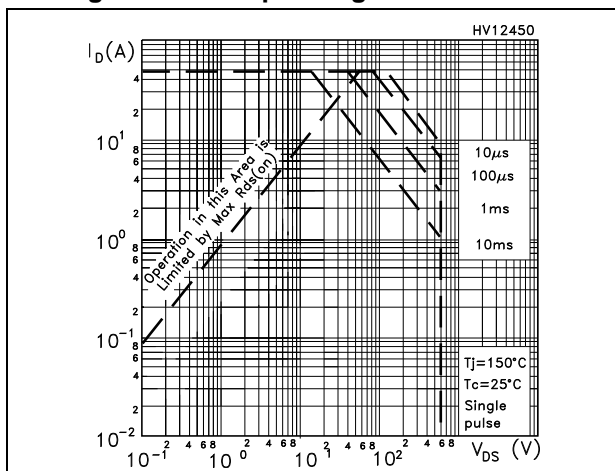

Figure 3. Thermal impedance for D<sup>2</sup>PAK

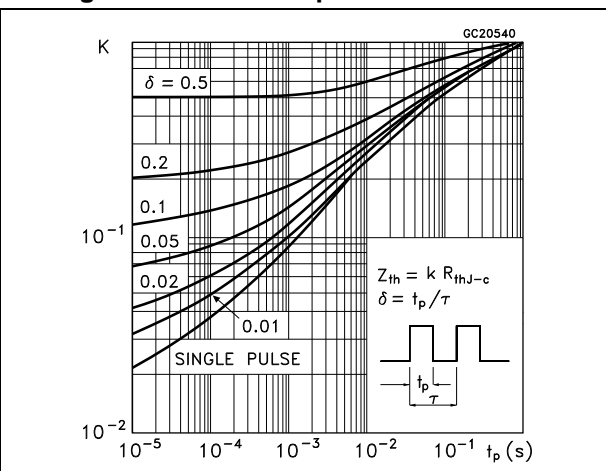

Figure 4. Safe operating area for TO-220FP

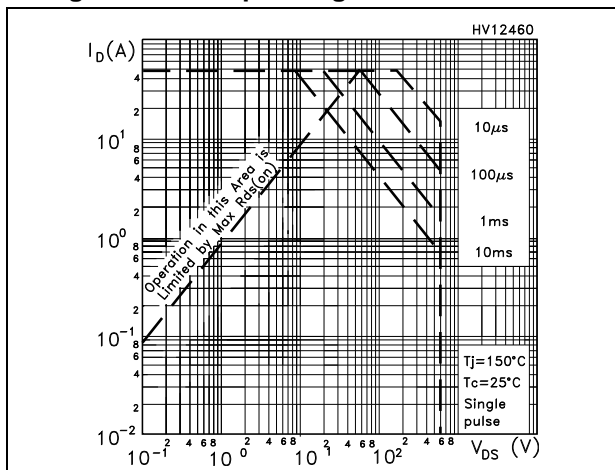

Figure 5. Thermal impedance for TO-220FP

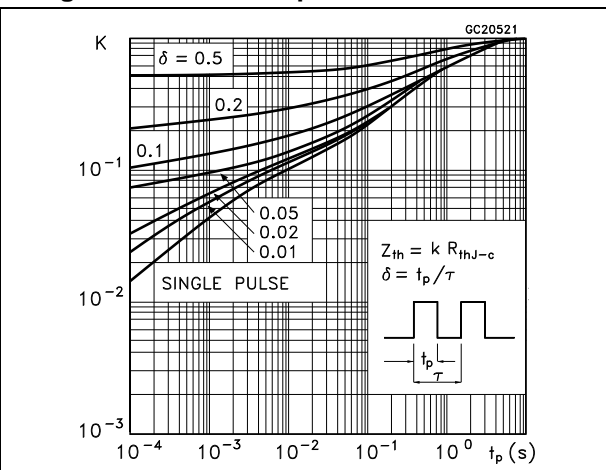

Figure 6. Output characteristics

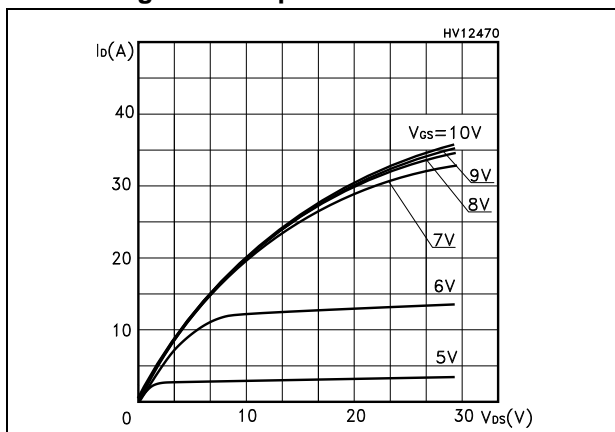

Figure 7. Transfer characteristics

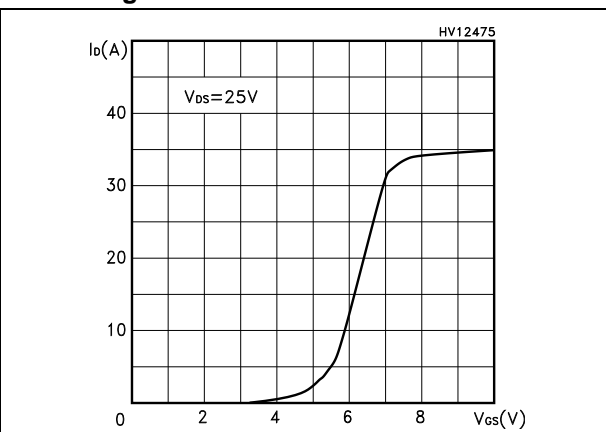

Figure 8. Transconductance

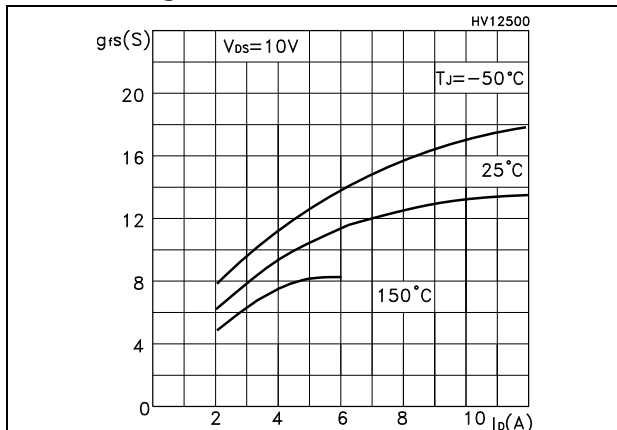

Figure 9. Static drain-source on-resistance

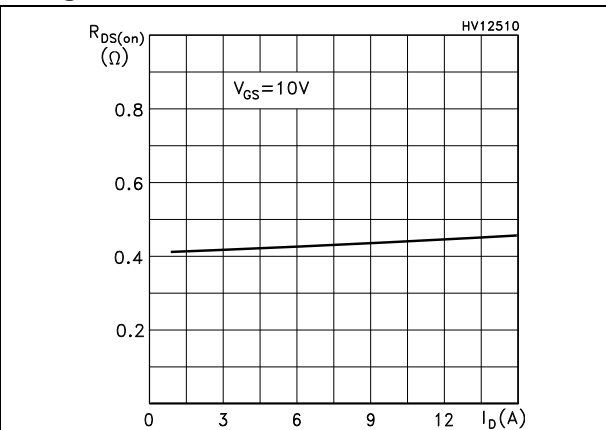

Figure 10. Gate charge vs gate-source voltage

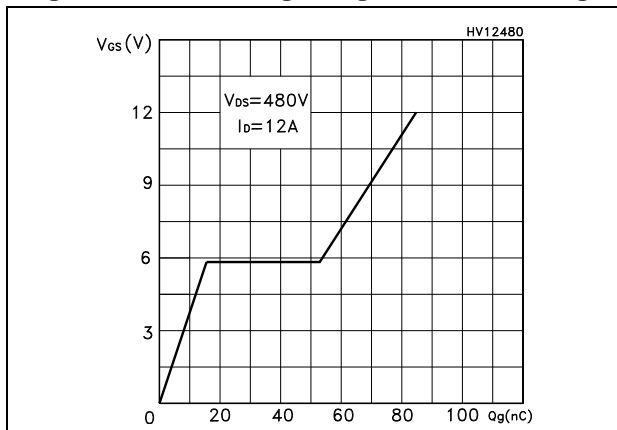

Figure 11. Capacitance variations

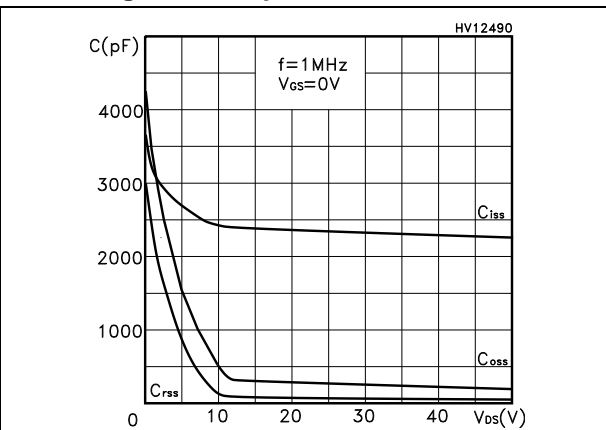

Figure 12. Normalized gate threshold voltage vs temperature

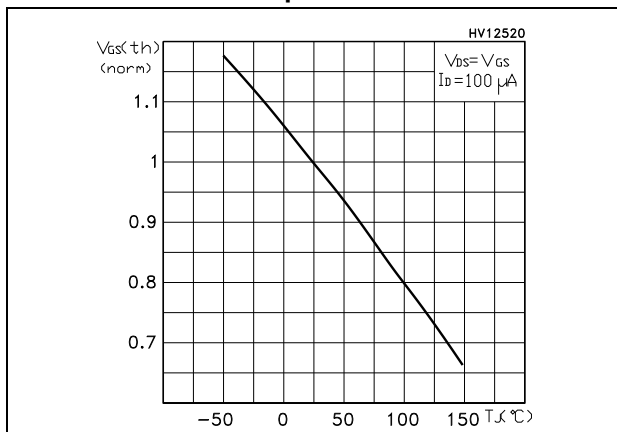

Figure 13. Normalized on-resistance vs temperature

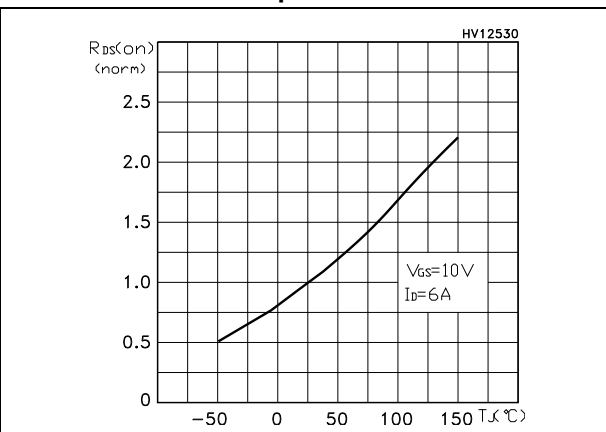

Figure 14. Source-drain diode forward characteristics

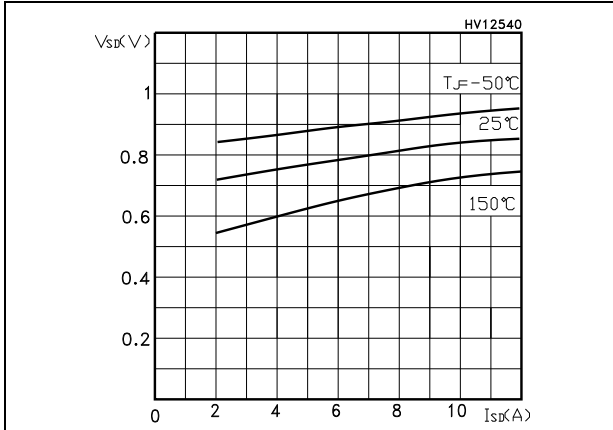

Figure 15. Normalized  $V_{(BR)DSS}$  vs temperature

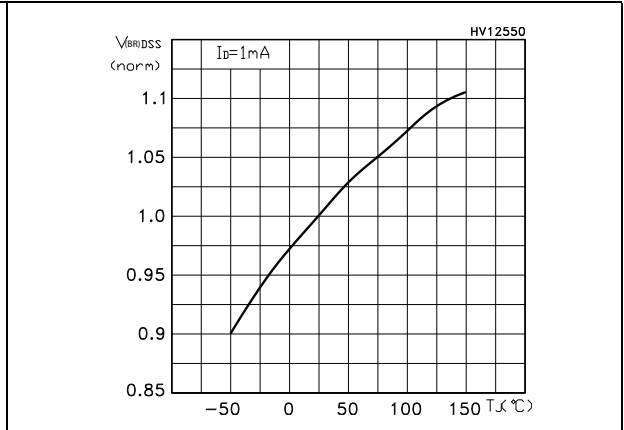
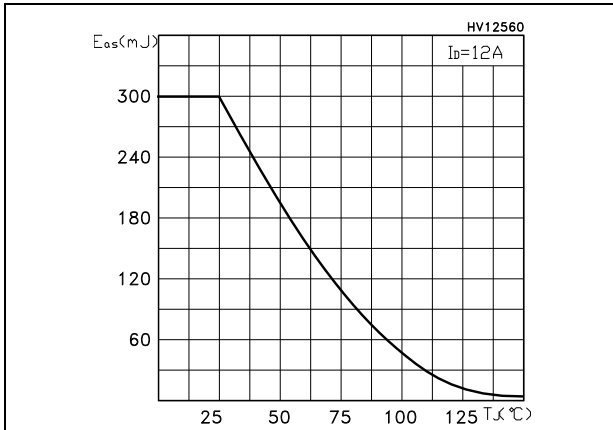

Figure 16. Maximum avalanche energy vs temperature





### 3 Test circuits

Figure 17. Switching times test circuit for resistive load



Figure 18. Gate charge test circuit



Figure 19. Test circuit for inductive load switching and diode recovery times



Figure 20. Unclamped inductive load test circuit



Figure 21. Unclamped inductive waveform



Figure 22. Switching time waveform



## 4 Package mechanical data

In order to meet environmental requirements, ST offers these devices in different grades of ECOPACK<sup>®</sup> packages, depending on their level of environmental compliance. ECOPACK<sup>®</sup> specifications, grade definitions and product status are available at: [www.st.com](http://www.st.com). ECOPACK<sup>®</sup> is an ST trademark.

### 4.1 D<sup>2</sup>PAK, STB14NK60ZT4

Figure 23. D<sup>2</sup>PAK (TO-263) drawing

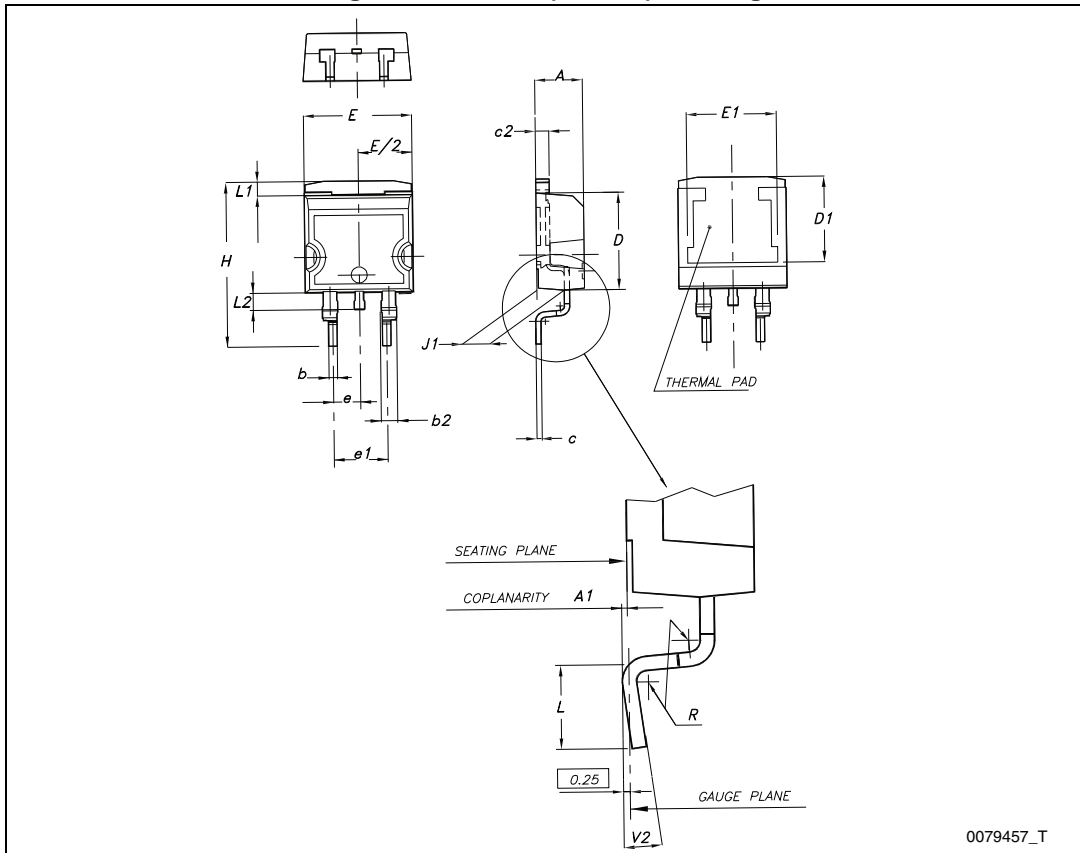
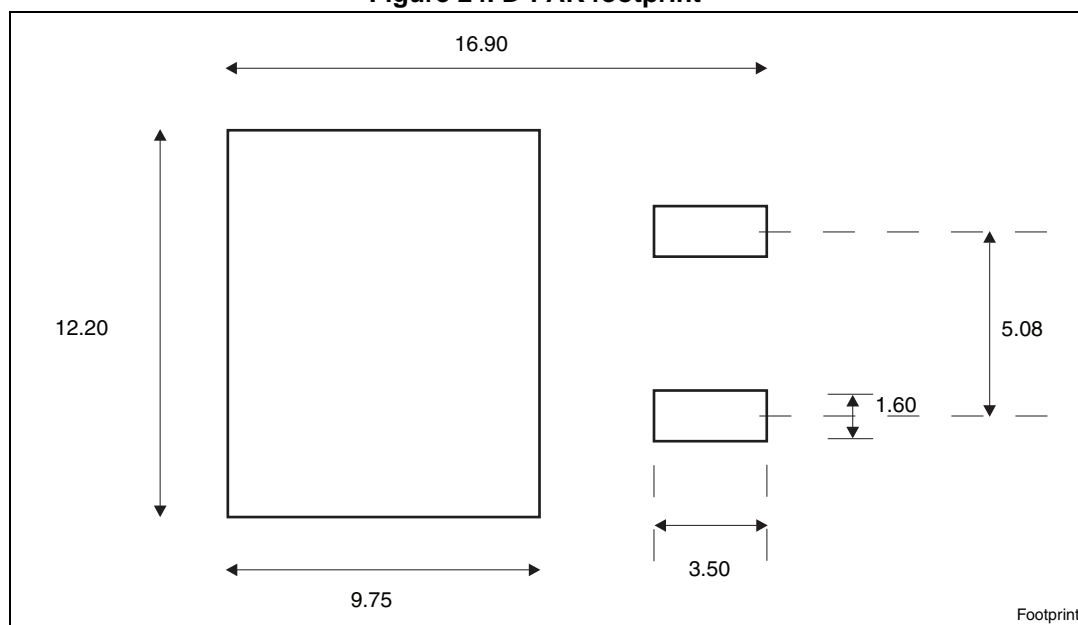

Table 10. D<sup>2</sup>PAK (TO-263) mechanical data

Dim.	mm		
	Min.	Typ.	Max.
A	4.40		4.60
A1	0.03		0.23
b	0.70		0.93
b2	1.14		1.70
c	0.45		0.60
c2	1.23		1.36
D	8.95		9.35
D1	7.50		
E	10		10.40
E1	8.50		
e		2.54	
e1	4.88		5.28
H	15		15.85
J1	2.49		2.69
L	2.29		2.79
L1	1.27		1.40
L2	1.30		1.75
R		0.4	
V2	0°		8°

Figure 24. D<sup>2</sup>PAK footprint<sup>(a)</sup>



a. All dimension are in millimeters

### 4.2 TO-220FP, STP14NK60ZFP

Figure 25. TO-220FP drawing

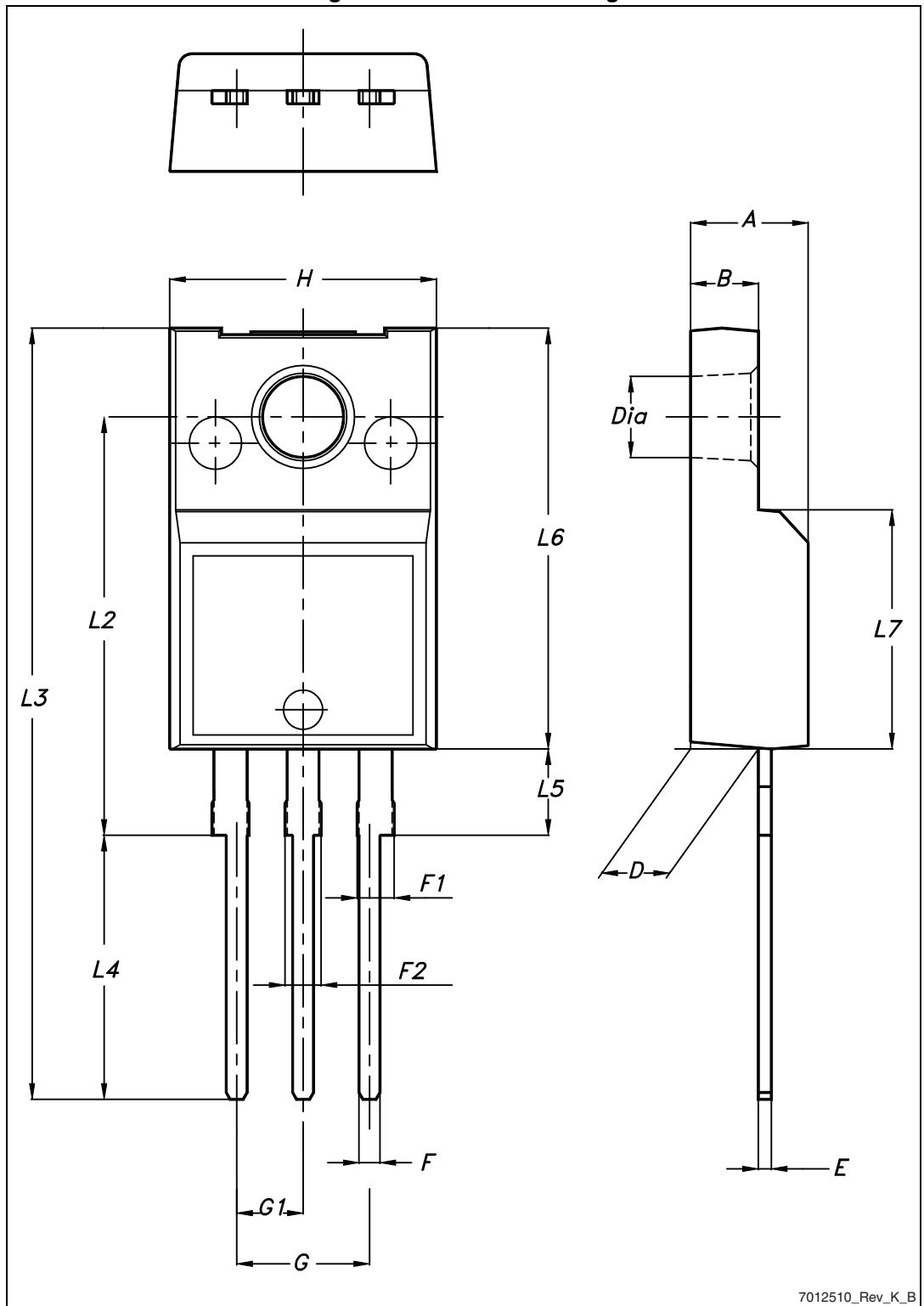

7012510\_Rev\_K\_B

Table 11. TO-220FP mechanical data

Dim.	mm		
	Min.	Typ.	Max.
A	4.4		4.6
B	2.5		2.7
D	2.5		2.75
E	0.45		0.7
F	0.75		1
F1	1.15		1.70
F2	1.15		1.70
G	4.95		5.2
G1	2.4		2.7
H	10		10.4
L2		16	
L3	28.6		30.6
L4	9.8		10.6
L5	2.9		3.6
L6	15.9		16.4
L7	9		9.3
Ø	3		3.2

# 5 Packaging mechanical data

Figure 26. Tape

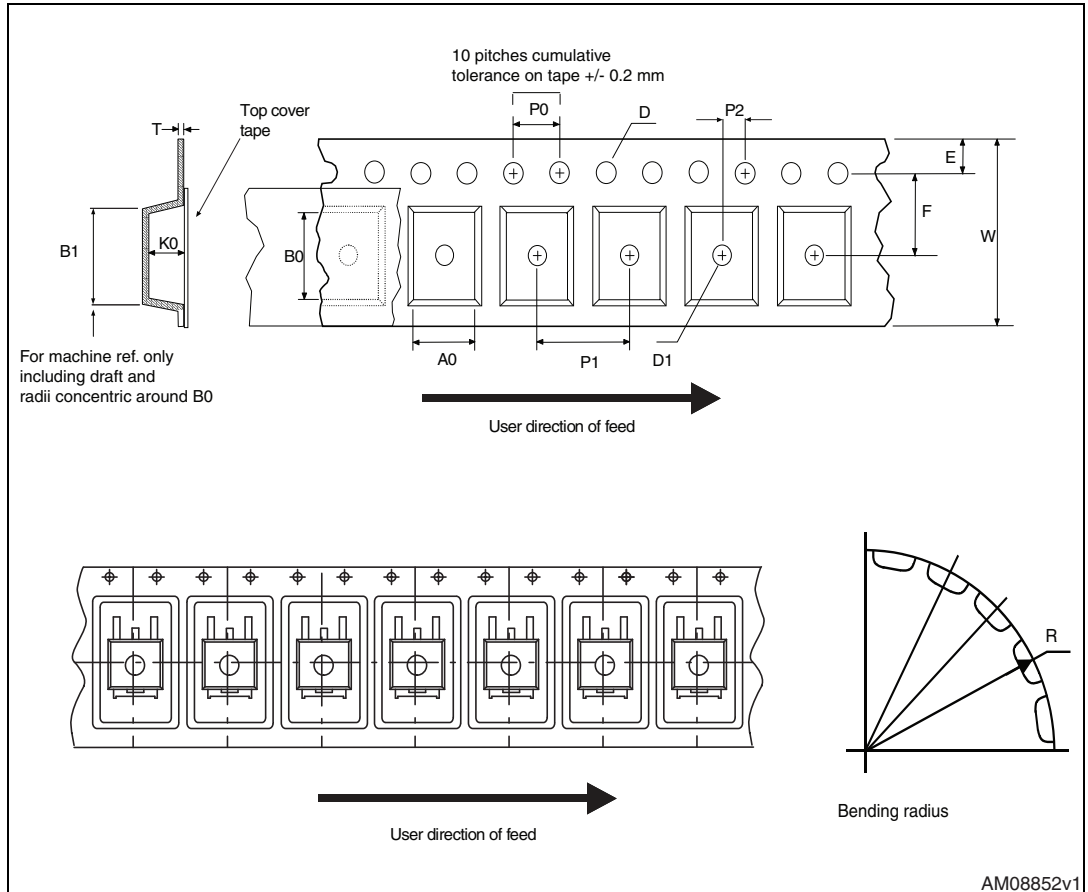



Figure 27. Reel

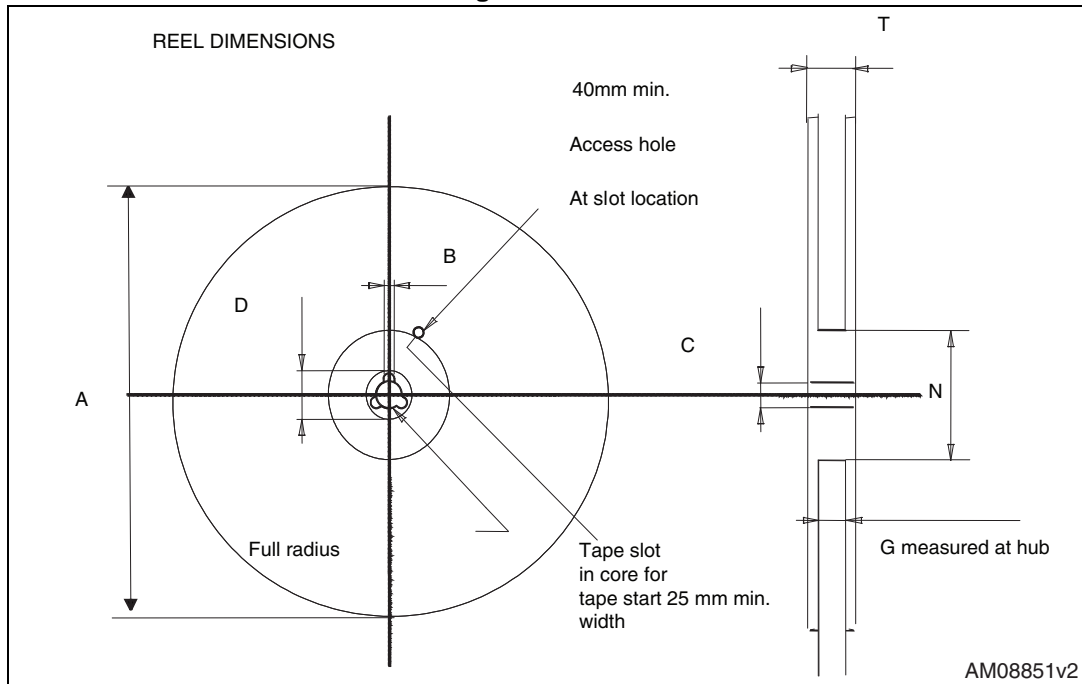

Table 12. D<sup>2</sup>PAK (TO-263) tape and reel mechanical data

Tape			Reel		
Dim.	mm		Dim.	mm	
	Min.	Max.		Min.	Max.
A0	10.5	10.7	A		330
B0	15.7	15.9	B	1.5	
D	1.5	1.6	C	12.8	13.2
D1	1.59	1.61	D	20.2	
E	1.65	1.85	G	24.4	26.4
F	11.4	11.6	N	100	
K0	4.8	5.0	T		30.4
P0	3.9	4.1			
P1	11.9	12.1	Base qty		1000
P2	1.9	2.1	Bulk qty		1000
R	50				
T	0.25	0.35			
W	23.7	24.3			

## 6 Revision history

**Table 13. Document revision history**

Date	Revision	Changes
06-May-2014	1	Initial release. Part numbers previously included in datasheet DocID8984

**Please Read Carefully:**

Information in this document is provided solely in connection with ST products. STMicroelectronics NV and its subsidiaries ("ST") reserve the right to make changes, corrections, modifications or improvements, to this document, and the products and services described herein at any time, without notice.

All ST products are sold pursuant to ST's terms and conditions of sale.

Purchasers are solely responsible for the choice, selection and use of the ST products and services described herein, and ST assumes no liability whatsoever relating to the choice, selection or use of the ST products and services described herein.

No license, express or implied, by estoppel or otherwise, to any intellectual property rights is granted under this document. If any part of this document refers to any third party products or services it shall not be deemed a license grant by ST for the use of such third party products or services, or any intellectual property contained therein or considered as a warranty covering the use in any manner whatsoever of such third party products or services or any intellectual property contained therein.

**UNLESS OTHERWISE SET FORTH IN ST'S TERMS AND CONDITIONS OF SALE ST DISCLAIMS ANY EXPRESS OR IMPLIED WARRANTY WITH RESPECT TO THE USE AND/OR SALE OF ST PRODUCTS INCLUDING WITHOUT LIMITATION IMPLIED WARRANTIES OF MERCHANTABILITY, FITNESS FOR A PARTICULAR PURPOSE (AND THEIR EQUIVALENTS UNDER THE LAWS OF ANY JURISDICTION), OR INFRINGEMENT OF ANY PATENT, COPYRIGHT OR OTHER INTELLECTUAL PROPERTY RIGHT.**

**ST PRODUCTS ARE NOT DESIGNED OR AUTHORIZED FOR USE IN: (A) SAFETY CRITICAL APPLICATIONS SUCH AS LIFE SUPPORTING, ACTIVE IMPLANTED DEVICES OR SYSTEMS WITH PRODUCT FUNCTIONAL SAFETY REQUIREMENTS; (B) AERONAUTIC APPLICATIONS; (C) AUTOMOTIVE APPLICATIONS OR ENVIRONMENTS, AND/OR (D) AEROSPACE APPLICATIONS OR ENVIRONMENTS. WHERE ST PRODUCTS ARE NOT DESIGNED FOR SUCH USE, THE PURCHASER SHALL USE PRODUCTS AT PURCHASER'S SOLE RISK, EVEN IF ST HAS BEEN INFORMED IN WRITING OF SUCH USAGE, UNLESS A PRODUCT IS EXPRESSLY DESIGNATED BY ST AS BEING INTENDED FOR "AUTOMOTIVE, AUTOMOTIVE SAFETY OR MEDICAL" INDUSTRY DOMAINS ACCORDING TO ST PRODUCT DESIGN SPECIFICATIONS. PRODUCTS FORMALLY ESCC, QML OR JAN QUALIFIED ARE DEEMED SUITABLE FOR USE IN AEROSPACE BY THE CORRESPONDING GOVERNMENTAL AGENCY.**

Resale of ST products with provisions different from the statements and/or technical features set forth in this document shall immediately void any warranty granted by ST for the ST product or service described herein and shall not create or extend in any manner whatsoever, any liability of ST.

ST and the ST logo are trademarks or registered trademarks of ST in various countries.

Information in this document supersedes and replaces all information previously supplied.

The ST logo is a registered trademark of STMicroelectronics. All other names are the property of their respective owners.

© 2014 STMicroelectronics - All rights reserved

STMicroelectronics group of companies

Australia - Belgium - Brazil - Canada - China - Czech Republic - Finland - France - Germany - Hong Kong - India - Israel - Italy - Japan - Malaysia - Malta - Morocco - Philippines - Singapore - Spain - Sweden - Switzerland - United Kingdom - United States of America

[www.st.com](http://www.st.com)



## X-ON Electronics

Largest Supplier of Electrical and Electronic Components

*Click to view similar products for [MOSFET](#) category:*

*Click to view products by [STMicroelectronics](#) manufacturer:*

Other Similar products are found below :

[614233C](#) [648584F](#) [IRFD120](#) [JANTX2N5237](#) [2N7000](#) [FCA20N60\\_F109](#) [FDZ595PZ](#) [2SK2545\(Q,T\)](#) [405094E](#) [423220D](#)  
[TPCC8103,L1Q\(CM](#) [MIC4420CM-TR](#) [VN1206L](#) [614234A](#) [715780A](#) [NTNS3166NZT5G](#) [SSM6J414TU,LF\(T](#) [751625C](#)  
[IPS70R2K0CEAKMA1](#) [BUK954R8-60E](#) [DMN3404LQ-7](#) [NTE6400](#) [SQJ402EP-T1-GE3](#) [2SK2614\(TE16L1,Q\)](#) [2N7002KW-FAI](#)  
[DMN1017UCP3-7](#) [EFC2J004NUZTDG](#) [ECH8691-TL-W](#) [FCAB21350L1](#) [P85W28HP2F-7071](#) [DMN1053UCP4-7](#) [NTE221](#) [NTE2384](#)  
[NTE2903](#) [NTE2941](#) [NTE2945](#) [NTE2946](#) [NTE2960](#) [NTE2967](#) [NTE2969](#) [NTE2976](#) [NTE455](#) [NTE6400A](#) [NTE2910](#) [NTE2916](#) [NTE2956](#)  
[NTE2911](#) [TK10A80W,S4X\(S](#) [SSM6P69NU,LF](#) [DMP22D4UFO-7B](#)