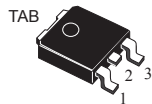
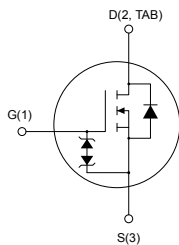

## N-channel 600 V, 345 mΩ typ., 10 A MDmesh DM6 Power MOSFET in a DPAK package

**DPAK**

AM01476v1\_tab

### Features

Order code	V <sub>DS</sub>	R <sub>DS(on)</sub> max.	I <sub>D</sub>
STD12N60DM6	600 V	390 mΩ	10 A

- Fast-recovery body diode
- Lower R<sub>DS(on)</sub> per area vs previous generation
- Low gate charge, input capacitance and resistance
- 100% avalanche tested
- Extremely high dv/dt ruggedness
- Zener-protected

### Applications

- Switching applications

### Description

This high-voltage N-channel Power MOSFET is part of the MDmesh DM6 fast-recovery diode series. Compared with the previous MDmesh fast generation, DM6 combines very low recovery charge (Q<sub>rr</sub>), recovery time (t<sub>rr</sub>) and excellent improvement in R<sub>DS(on)</sub> per area with one of the most effective switching behaviors available in the market for the most demanding high-efficiency bridge topologies and ZVS phase-shift converters.



#### Product status link

[STD12N60DM6](#)

#### Product summary

<b>Order code</b>	STD12N60DM6
<b>Marking</b>	12N60DM6
<b>Package</b>	DPAK
<b>Packing</b>	Tape and reel

# 1 Electrical ratings

**Table 1. Absolute maximum ratings**

Symbol	Parameter	Value	Unit
$V_{GS}$	Gate-source voltage	$\pm 25$	V
$I_D$	Drain current (continuous) at $T_C = 25\text{ }^\circ\text{C}$	10	A
	Drain current (continuous) at $T_C = 100\text{ }^\circ\text{C}$	6.3	
$I_{DM}^{(1)}$	Drain current (pulsed)	28	A
$P_{TOT}$	Total power dissipation at $T_C = 25\text{ }^\circ\text{C}$	90	W
$I_{AR}^{(2)}$	Avalanche current, repetitive or not repetitive	3	A
$E_{AS}^{(3)}$	Single pulse avalanche energy	195	mJ
$dv/dt^{(4)}$	Peak diode recovery voltage slope	100	V/ns
$di/dt^{(4)}$	Peak diode recovery current slope	1000	A/ $\mu\text{s}$
$dv/dt^{(5)}$	MOSFET $dv/dt$ ruggedness	100	V/ns
$T_{stg}$	Storage temperature range	-55 to 150	$^\circ\text{C}$
$T_J$	Operating junction temperature range		$^\circ\text{C}$

1. Pulse width is limited by safe operating area.
2. Pulse width limited by  $T_J$  max.
3. Starting  $T_J = 25\text{ }^\circ\text{C}$ ,  $I_D = I_{AR}$ ,  $V_{DD} = 50\text{ V}$ .
4.  $I_{SD} \leq 10\text{ A}$ ,  $V_{DS} (\text{peak}) < V_{(BR)DSS}$ ,  $V_{DD} = 400\text{ V}$ .
5.  $V_{DS} \leq 480\text{ V}$ .

**Table 2. Thermal data**

Symbol	Parameter	Value	Unit
$R_{thj-case}$	Thermal resistance junction-case	1.39	$^\circ\text{C/W}$
$R_{thj-pcb}^{(1)}$	Thermal resistance junction-pcb	50	$^\circ\text{C/W}$

1. When mounted on an 1-inch<sup>2</sup> FR-4, 2 Oz copper board.

## 2 Electrical characteristics

( $T_C = 25\text{ °C}$  unless otherwise specified)

**Table 3. On/off states**

Symbol	Parameter	Test conditions	Min.	Typ.	Max.	Unit
$V_{(BR)DSS}$	Drain-source breakdown voltage	$V_{GS} = 0\text{ V}$ , $I_D = 1\text{ mA}$	600			V
$I_{DSS}$	Zero gate voltage drain current	$V_{GS} = 0\text{ V}$ , $V_{DS} = 600\text{ V}$			1	$\mu\text{A}$
		$V_{GS} = 0\text{ V}$ , $V_{DS} = 600\text{ V}$ , $T_C = 125\text{ °C}$ <sup>(1)</sup>			100	
$I_{GSS}$	Gate-body leakage current	$V_{DS} = 0\text{ V}$ , $V_{GS} = \pm 25\text{ V}$			$\pm 5$	$\mu\text{A}$
$V_{GS(th)}$	Gate threshold voltage	$V_{DS} = V_{GS}$ , $I_D = 250\text{ }\mu\text{A}$	3.25	4	4.75	V
$R_{DS(on)}$	Static drain-source on-resistance	$V_{GS} = 10\text{ V}$ , $I_D = 5\text{ A}$		345	390	m $\Omega$

1. Defined by design, not subject to production test.

**Table 4. Dynamic**

Symbol	Parameter	Test conditions	Min.	Typ.	Max.	Unit
$C_{iss}$	Input capacitance	$V_{GS} = 100\text{ V}$ , $f = 1\text{ MHz}$ , $V_{GS} = 0\text{ V}$	-	508	-	pF
$C_{oss}$	Output capacitance		-	28	-	pF
$C_{rss}$	Reverse transfer capacitance		-	4.7	-	pF
$C_{oss\text{ eq.}}^{(1)}$	Equivalent output capacitance	$V_{DS} = 0\text{ to }480\text{ V}$ , $V_{GS} = 0\text{ V}$	-	100	-	pF
$R_G$	Intrinsic gate resistance	$f = 1\text{ MHz}$ open drain	-	5.8	-	$\Omega$
$Q_g$	Total gate charge	$V_{DD} = 480\text{ V}$ , $I_D = 10\text{ A}$ , $V_{GS} = 0\text{ to }10\text{ V}$ (see Figure 14. Test circuit for gate charge behavior)	-	17	-	nC
$Q_{gs}$	Gate-source charge		-	3.8	-	nC
$Q_{gd}$	Gate-drain charge		-	9.3	-	nC

1.  $C_{oss\text{ eq.}}$  is defined as a constant equivalent capacitance giving the same charging time as  $C_{oss}$  when  $V_{DS}$  increases from 0 to 80%  $V_{DSS}$ .

**Table 5. Switching times**

Symbol	Parameter	Test conditions	Min.	Typ.	Max.	Unit
$t_{d(on)}$	Turn-on delay time	$V_{DD} = 300\text{ V}$ , $I_D = 5\text{ A}$ , $R_G = 4.7\text{ }\Omega$ , $V_{GS} = 10\text{ V}$	-	11	-	ns
$t_r$	Rise time		-	4.3	-	ns
$t_{d(off)}$	Turn-off delay time	(see Figure 13. Test circuit for resistive load switching times and Figure 18. Switching time waveform)	-	26	-	ns
$t_f$	Fall time		-	7.3	-	ns

**Table 6. Source-drain diode**

Symbol	Parameter	Test conditions	Min.	Typ.	Max.	Unit
$I_{SD}$	Source-drain current		-		10	A
$I_{SDM}^{(1)}$	Source-drain current (pulsed)		-		28	A
$V_{SD}^{(2)}$	Forward on voltage	$V_{GS} = 0\text{ V}$ , $I_{SD} = 10\text{ A}$	-		1.6	V
$t_{rr}$	Reverse recovery time	$I_{SD} = 10\text{ A}$ , $di/dt = 100\text{ A}/\mu\text{s}$ ,	-	80		ns
$Q_{rr}$	Reverse recovery charge	$V_{DD} = 60\text{ V}$	-	0.288		$\mu\text{C}$
$I_{RRM}$	Reverse recovery current	(see Figure 15. Test circuit for inductive load switching and diode recovery times)	-	7.2		A
$t_{rr}$	Reverse recovery time	$I_{SD} = 10\text{ A}$ , $di/dt = 100\text{ A}/\mu\text{s}$ ,	-	148		ns
$Q_{rr}$	Reverse recovery charge	$V_{DD} = 60\text{ V}$ , $T_J = 150\text{ }^\circ\text{C}$	-	0.680		$\mu\text{C}$
$I_{RRM}$	Reverse recovery current	(see Figure 15. Test circuit for inductive load switching and diode recovery times)	-	9.2		A

1. Pulse width is limited by safe operating area.
2. Pulse test: pulse duration = 300  $\mu\text{s}$ , duty cycle 1.5%.

## 2.1 Electrical characteristics (curves)

**Figure 1. Safe operating area**

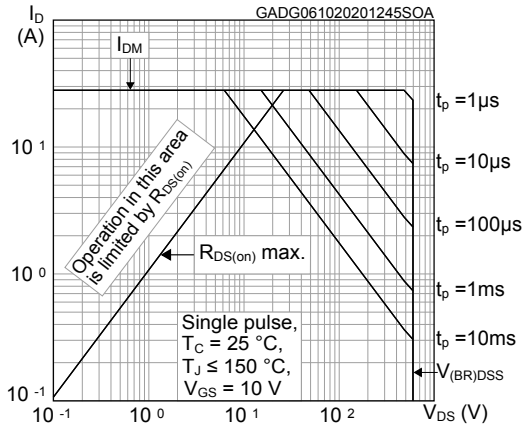

**Figure 2. Maximum transient thermal impedance**

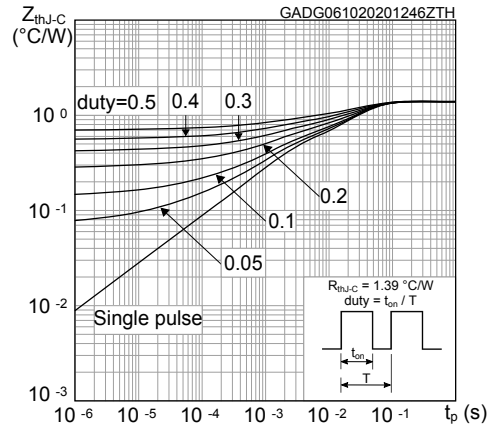

**Figure 3. Typical output characteristics**

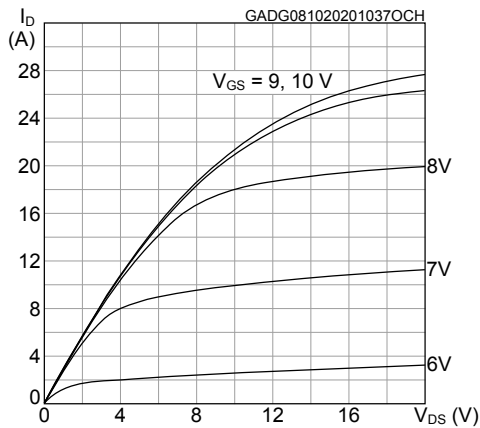

**Figure 4. Typical transfer characteristics**

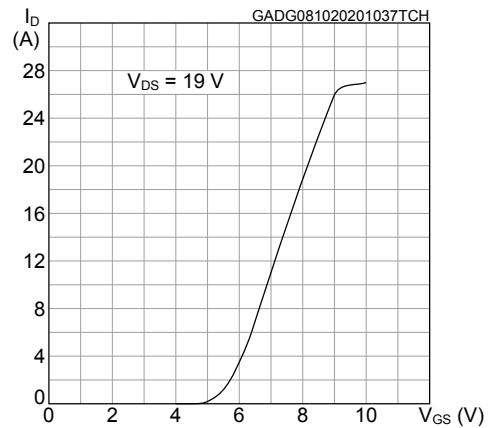

**Figure 5. Typical gate charge characteristics**

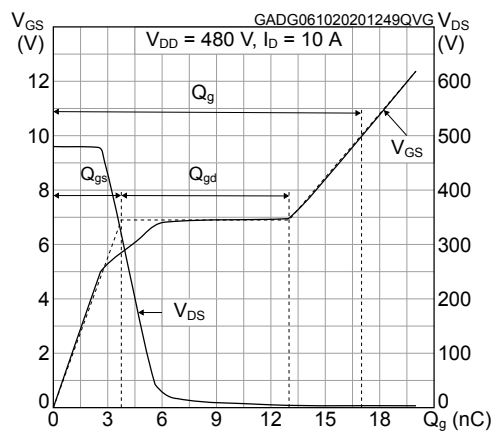

**Figure 6. Typical drain-source on-resistance**

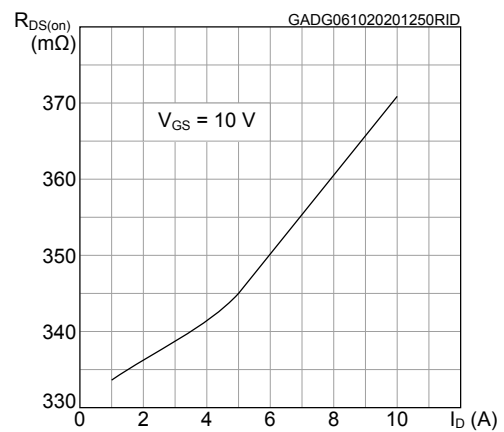

**Figure 7. Typical capacitance characteristics**

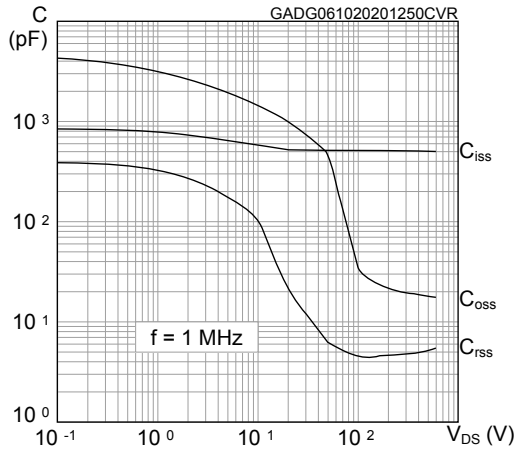

**Figure 8. Typical output capacitance stored energy**

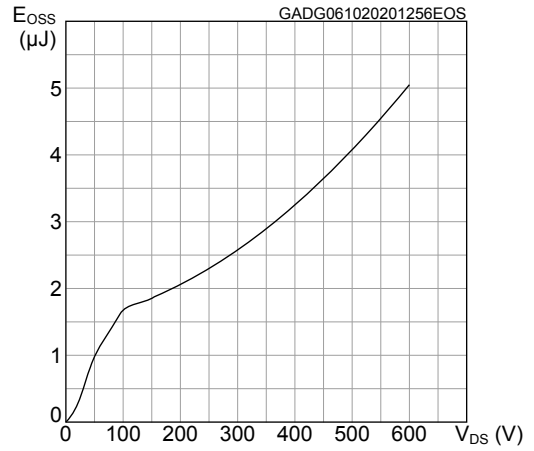

**Figure 9. Normalized gate threshold vs temperature**

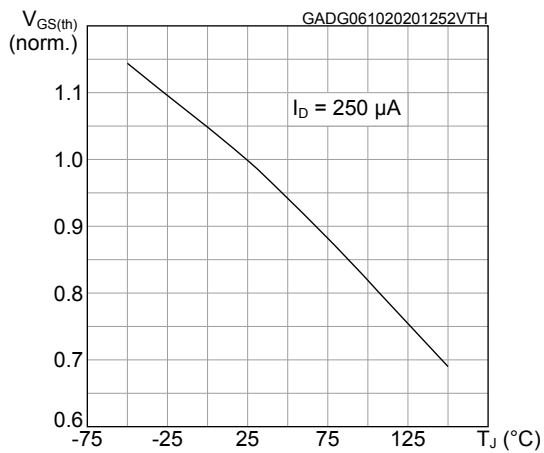

**Figure 10. Normalized on-resistance vs temperature**

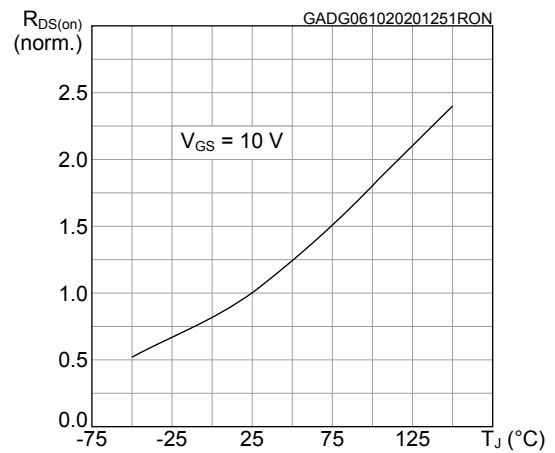

**Figure 11. Normalized breakdown voltage vs temperature**

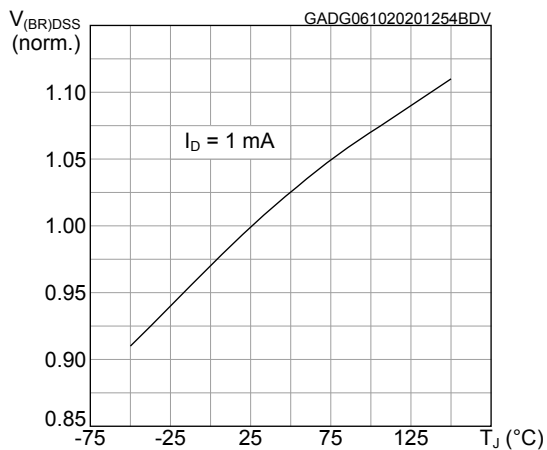

**Figure 12. Typical reverse diode forward characteristics**

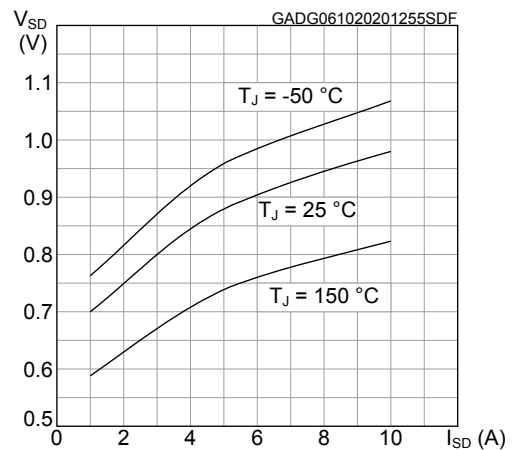

### 3 Test circuits

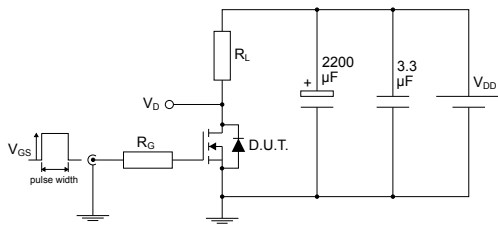
**Figure 13. Test circuit for resistive load switching times**

AM01468v1

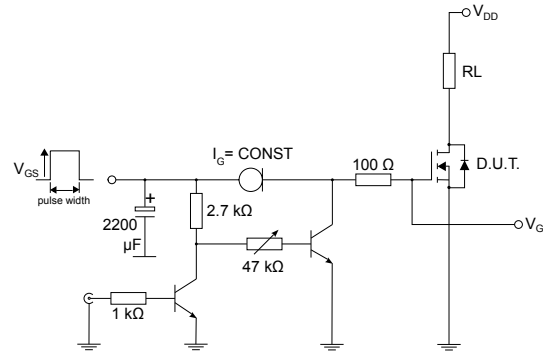
**Figure 14. Test circuit for gate charge behavior**

AM01469v10

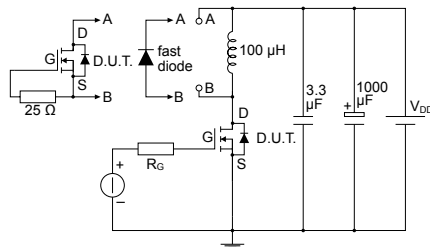
**Figure 15. Test circuit for inductive load switching and diode recovery times**

AM01470v1

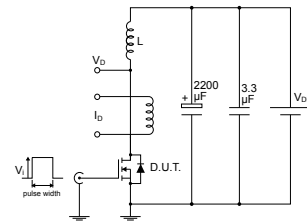
**Figure 16. Unclamped inductive load test circuit**

AM01471v1

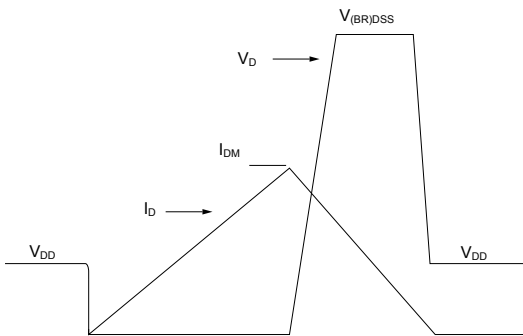
**Figure 17. Unclamped inductive waveform**

AM01472v1

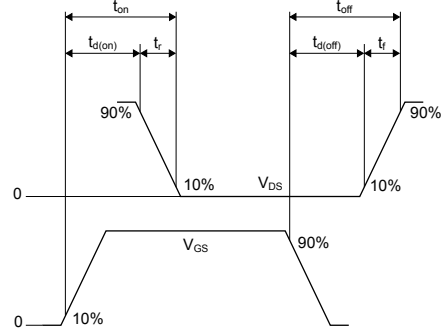
**Figure 18. Switching time waveform**

AM01473v1

## 4 Package information

In order to meet environmental requirements, ST offers these devices in different grades of **ECOPACK** packages, depending on their level of environmental compliance. ECOPACK specifications, grade definitions and product status are available at: [www.st.com](http://www.st.com). ECOPACK is an ST trademark.

### 4.1 DPAK (TO-252) type A2 package information

**Figure 19.** DPAK (TO-252) type A2 package outline

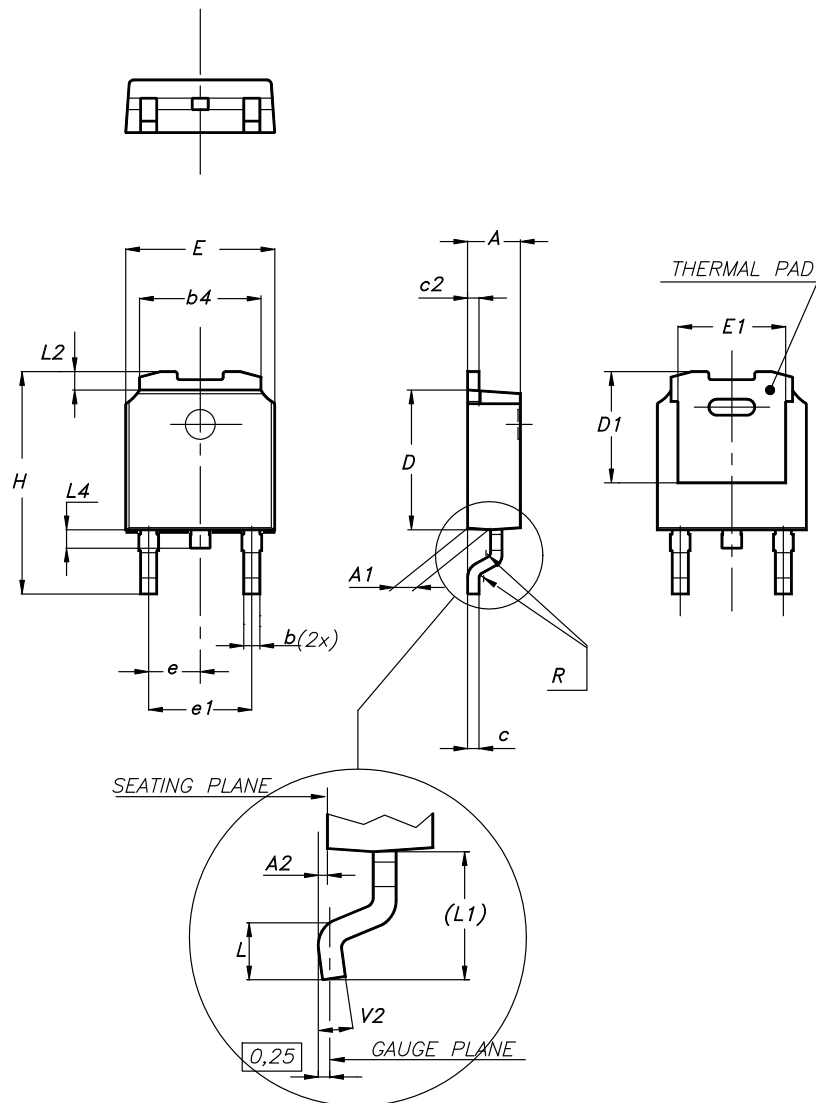

0068772\_type-A2\_rev30



**Table 7. DPAK (TO-252) type A2 mechanical data**

Dim.	mm		
	Min.	Typ.	Max.
A	2.20		2.40
A1	0.90		1.10
A2	0.03		0.23
b	0.64		0.90
b4	5.20		5.40
c	0.45		0.60
c2	0.48		0.60
D	6.00		6.20
D1	4.95	5.10	5.25
E	6.40		6.60
E1	5.10	5.20	5.30
e	2.159	2.286	2.413
e1	4.445	4.572	4.699
H	9.35		10.10
L	1.00		1.50
L1	2.60	2.80	3.00
L2	0.65	0.80	0.95
L4	0.60		1.00
R		0.20	
V2	0°		8°

Figure 20. DPAK (TO-252) recommended footprint (dimensions are in mm)

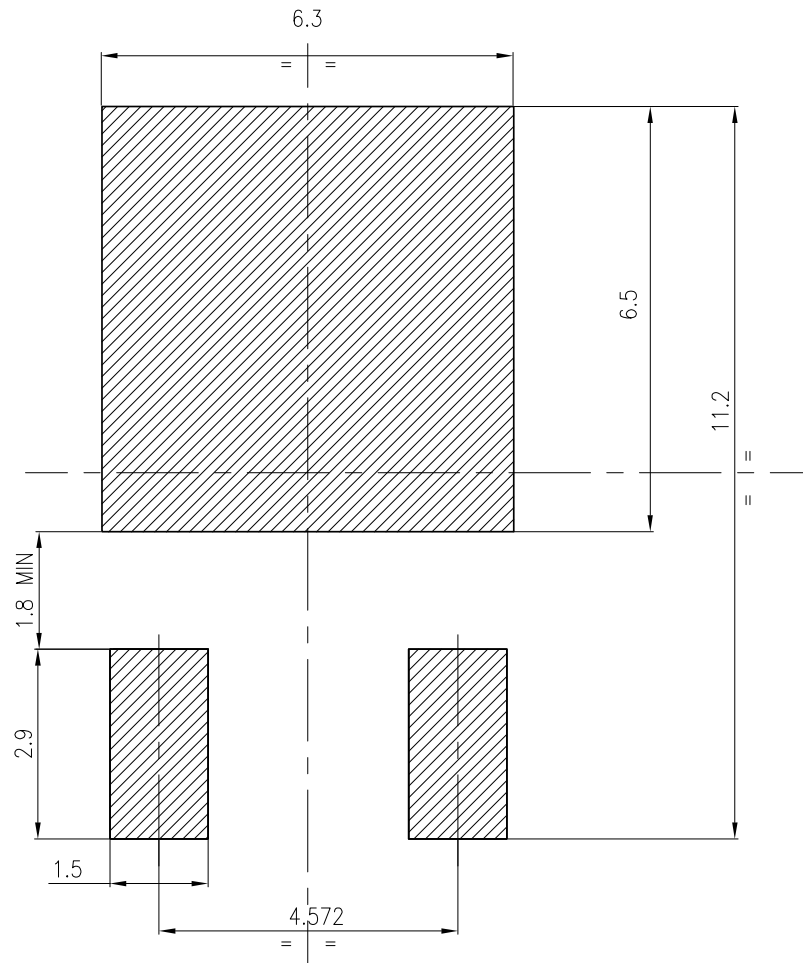

FP\_0068772\_30

## 4.2 DPAK (TO-252) packing information

Figure 21. DPAK (TO-252) tape outline

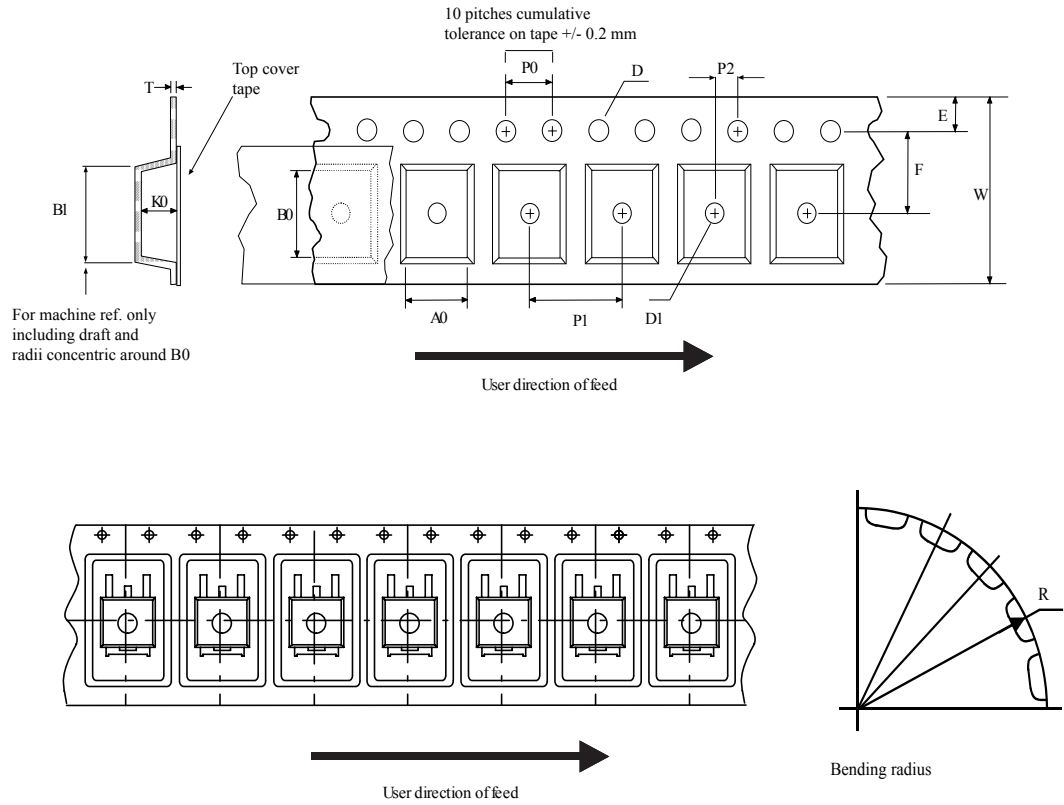

AM08852v1

**Figure 22. DPAK (TO-252) reel outline**

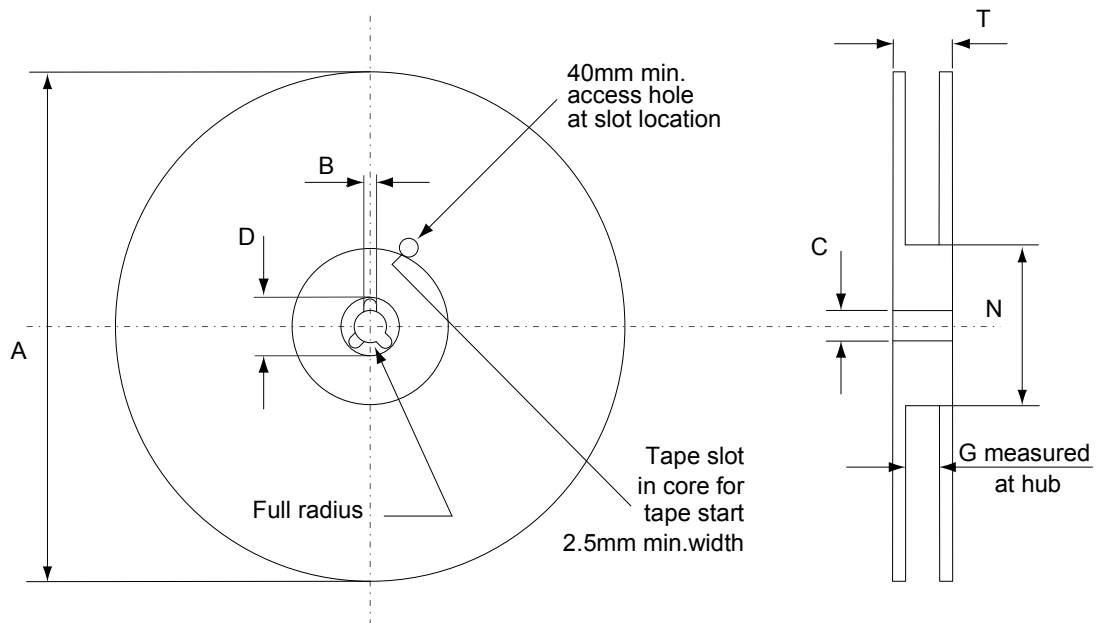

AM06038v1

**Table 8. DPAK (TO-252) tape and reel mechanical data**

Dim.	Tape		Dim.	Reel	
	mm			mm	
	Min.	Max.		Min.	Max.
A0	6.8	7	A		330
B0	10.4	10.6	B	1.5	
B1		12.1	C	12.8	13.2
D	1.5	1.6	D	20.2	
D1	1.5		G	16.4	18.4
E	1.65	1.85	N	50	
F	7.4	7.6	T		22.4
K0	2.55	2.75			
P0	3.9	4.1		Base qty.	2500
P1	7.9	8.1		Bulk qty.	2500
P2	1.9	2.1			
R	40				
T	0.25	0.35			
W	15.7	16.3			

## Revision history

**Table 9. Document revision history**

Date	Version	Changes
09-Oct-2020	1	First release.

---

## Contents

<b>1</b>	<b>Electrical ratings</b> .....	<b>2</b>
<b>2</b>	<b>Electrical characteristics</b> .....	<b>3</b>
<b>2.1</b>	Electrical characteristics (curves) .....	<b>5</b>
<b>3</b>	<b>Test circuits</b> .....	<b>7</b>
<b>4</b>	<b>Package information</b> .....	<b>8</b>
<b>4.1</b>	DPAK (TO-252) type A2 package information .....	<b>8</b>
<b>4.2</b>	DPAK (TO-252) packing information .....	<b>11</b>
	<b>Revision history</b> .....	<b>13</b>

**IMPORTANT NOTICE – PLEASE READ CAREFULLY**

STMicroelectronics NV and its subsidiaries (“ST”) reserve the right to make changes, corrections, enhancements, modifications, and improvements to ST products and/or to this document at any time without notice. Purchasers should obtain the latest relevant information on ST products before placing orders. ST products are sold pursuant to ST’s terms and conditions of sale in place at the time of order acknowledgement.

Purchasers are solely responsible for the choice, selection, and use of ST products and ST assumes no liability for application assistance or the design of Purchasers’ products.

No license, express or implied, to any intellectual property right is granted by ST herein.

Resale of ST products with provisions different from the information set forth herein shall void any warranty granted by ST for such product.

ST and the ST logo are trademarks of ST. For additional information about ST trademarks, please refer to [www.st.com/trademarks](http://www.st.com/trademarks). All other product or service names are the property of their respective owners.

Information in this document supersedes and replaces information previously supplied in any prior versions of this document.

© 2020 STMicroelectronics – All rights reserved

## X-ON Electronics

Largest Supplier of Electrical and Electronic Components

*Click to view similar products for [MOSFET](#) category:*

*Click to view products by [STMicroelectronics](#) manufacturer:*

Other Similar products are found below :

[614233C](#) [648584F](#) [IRFD120](#) [JANTX2N5237](#) [2N7000](#) [FCA20N60\\_F109](#) [FDZ595PZ](#) [2SK2545\(Q,T\)](#) [405094E](#) [423220D](#)  
[TPCC8103,L1Q\(CM](#) [MIC4420CM-TR](#) [VN1206L](#) [614234A](#) [715780A](#) [NTNS3166NZT5G](#) [SSM6J414TU,LF\(T](#) [751625C](#)  
[IPS70R2K0CEAKMA1](#) [BUK954R8-60E](#) [DMN3404LQ-7](#) [NTE6400](#) [SQJ402EP-T1-GE3](#) [2SK2614\(TE16L1,Q\)](#) [2N7002KW-FAI](#)  
[DMN1017UCP3-7](#) [EFC2J004NUZTDG](#) [ECH8691-TL-W](#) [FCAB21350L1](#) [P85W28HP2F-7071](#) [DMN1053UCP4-7](#) [NTE221](#) [NTE2384](#)  
[NTE2903](#) [NTE2941](#) [NTE2945](#) [NTE2946](#) [NTE2960](#) [NTE2967](#) [NTE2969](#) [NTE2976](#) [NTE455](#) [NTE6400A](#) [NTE2910](#) [NTE2916](#) [NTE2956](#)  
[NTE2911](#) [TK10A80W,S4X\(S](#) [SSM6P69NU,LF](#) [DMP22D4UFO-7B](#)