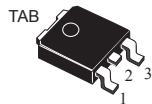
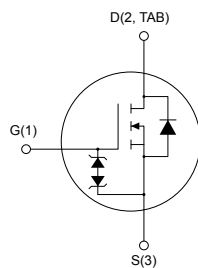

N-channel 600 V, 0.340 Ω typ., 11 A MDmesh™ M2 EP Power MOSFET in a DPAK package

DPAK

AM01475V1

Features

Order code	$V_{DS} @ T_{Jmax}$	$R_{DS(on)}$ max.	I_D
STD15N60M2-EP	650 V	0.378 Ω	11 A

- Extremely low gate charge
- Excellent output capacitance (C_{OSS}) profile
- Very low turn-off switching losses
- 100% avalanche tested
- Zener-protected

Applications

- Switching applications
- Tailored for very high frequency converters ($f > 150$ kHz)

Description

This device is an N-channel Power MOSFET developed using MDmesh™ M2 enhanced performance (EP) technology. Thanks to its strip layout and an improved vertical structure, the device exhibits low on-resistance, optimized switching characteristics with very low turn-off switching losses, rendering it suitable for the most demanding very high frequency converters.

Product status

STD15N60M2-EP

Product summary

Order code	STD15N60M2-EP
Marking	15N60M2EP
Package	DPAK
Packing	Tape and reel

1 Electrical ratings

Table 1. Absolute maximum ratings

Symbol	Parameter	Value	Unit
V_{GS}	Gate-source voltage	± 25	V
I_D	Drain current (continuous) at $T_C = 25\text{ }^\circ\text{C}$	11	A
I_D	Drain current (continuous) at $T_C = 100\text{ }^\circ\text{C}$	7	A
$I_{DM}^{(1)}$	Drain current (pulsed)	44	A
P_{TOT}	Total dissipation at $T_C = 25\text{ }^\circ\text{C}$	110	W
$dv/dt^{(2)}$	Peak diode recovery voltage slope	15	V/ns
$dv/dt^{(3)}$	MOSFET dv/dt ruggedness	50	V/ns
T_{stg}	Storage temperature range	-55 to 150	$^\circ\text{C}$
T_j	Operating junction temperature range		

1. Pulse width limited by safe operating area.
2. $I_{SD} \leq 11\text{ A}$, $di/dt \leq 400\text{ A}/\mu\text{s}$, $V_{DS\ peak} < V_{(BR)DSS}$, $V_{DD} = 400\text{ V}$.
3. $V_{DS} \leq 480\text{ V}$

Table 2. Thermal data

Symbol	Parameter	Value	Unit
$R_{thj-case}$	Thermal resistance junction-case	1.14	$^\circ\text{C}/\text{W}$
$R_{thj-pcb}^{(1)}$	Thermal resistance junction-pcb	50	$^\circ\text{C}/\text{W}$

1. When mounted on FR-4 board of 1 inch², 2 oz Cu

Table 3. Avalanche characteristics

Symbol	Parameter	Value	Unit
I_{AR}	Avalanche current, repetitive or not repetitive (pulse width limited by T_{jmax})	2.8	A
E_{AS}	Single pulse avalanche energy (starting $T_j = 25\text{ }^\circ\text{C}$, $I_D = I_{AR}$, $V_{DD} = 50\text{ V}$)	125	mJ

2 Electrical characteristics

$T_C = 25\text{ }^\circ\text{C}$ unless otherwise specified

Table 4. On/off states

Symbol	Parameter	Test conditions	Min.	Typ.	Max.	Unit
$V_{(BR)DSS}$	Drain-source breakdown voltage	$V_{GS} = 0\text{ V}, I_D = 1\text{ mA}$	600			V
I_{DSS}	Zero gate voltage drain current	$V_{GS} = 0\text{ V}, V_{DS} = 600\text{ V}$			1	μA
		$V_{GS} = 0\text{ V}, V_{DS} = 600\text{ V}, T_C = 125\text{ }^\circ\text{C}^{(1)}$			100	μA
I_{GSS}	Gate-body leakage current	$V_{DS} = 0\text{ V}, V_{GS} = \pm 25\text{ V}$			± 10	μA
$V_{GS(th)}$	Gate threshold voltage	$V_{DS} = V_{GS}, I_D = 250\text{ }\mu\text{A}$	3.25	4	4.75	V
$R_{DS(on)}$	Static drain-source on-resistance	$V_{GS} = 10\text{ V}, I_D = 5.5\text{ A}$		0.340	0.378	Ω

1. Defined by design, not subject to production test.

Table 5. Dynamic

Symbol	Parameter	Test conditions	Min.	Typ.	Max.	Unit
C_{iss}	Input capacitance	$V_{DS} = 100\text{ V}, f = 1\text{ MHz}, V_{GS} = 0\text{ V}$	-	590	-	pF
C_{oss}	Output capacitance		-	30	-	pF
C_{riss}	Reverse transfer capacitance		-	1.1	-	pF
$C_{oss\text{ eq.}}^{(1)}$	Equivalent output capacitance	$V_{DS} = 0\text{ to }480\text{ V}, V_{GS} = 0\text{ V}$	-	148	-	pF
R_G	Intrinsic gate resistance	$f = 1\text{ MHz}, I_D = 0\text{ A}$	-	7	-	Ω
Q_g	Total gate charge	$V_{DD} = 480\text{ V}, I_D = 11\text{ A}, V_{GS} = 0\text{ to }10\text{ V}$ (see Figure 15. Test circuit for gate charge behavior)	-	17	-	nC
Q_{gs}	Gate-source charge		-	3.1	-	nC
Q_{gd}	Gate-drain charge		-	7.3	-	nC

1. $C_{oss\text{ eq.}}$ is defined as a constant equivalent capacitance giving the same charging time as C_{oss} when V_{DS} increases from 0 to 80% V_{DSS} .

Table 6. Switching energy

Symbol	Parameter	Test conditions	Min.	Typ.	Max.	Unit
$E_{(off)}$	Turn-off energy (from 90% V_{GS} to 0% I_D)	$V_{DD} = 400\text{ V}, I_D = 1.5\text{ A}, R_G = 4.7\text{ }\Omega, V_{GS} = 10\text{ V}$	-	4.7	-	μJ
		$V_{DD} = 400\text{ V}, I_D = 3.5\text{ A}, R_G = 4.7\text{ }\Omega, V_{GS} = 10\text{ V}$	-	5.2	-	μJ

Table 7. Switching times

Symbol	Parameter	Test conditions	Min.	Typ.	Max.	Unit
$t_{d(on)}$	Turn-on delay time	$V_{DD} = 300\text{ V}$, $I_D = 5.5\text{ A}$, $R_G = 4.7\ \Omega$, $V_{GS} = 10\text{ V}$ (see Figure 14. Test circuit for resistive load switching times and Figure 19. Switching time waveform)	-	11	-	ns
t_r	Rise time		-	10	-	ns
$t_{d(off)}$	Turn-off delay time		-	40	-	ns
t_f	Fall time		-	15	-	ns

Table 8. Source drain diode

Symbol	Parameter	Test conditions	Min.	Typ.	Max.	Unit
I_{SD}	Source-drain current		-		11	A
$I_{SDM}^{(1)}$	Source-drain current (pulsed)		-		44	A
$V_{SD}^{(2)}$	Forward on voltage	$V_{GS} = 0\text{ V}$, $I_{SD} = 11\text{ A}$	-		1.6	V
t_{rr}	Reverse recovery time	$I_{SD} = 11\text{ A}$, $di/dt = 100\text{ A}/\mu\text{s}$, $V_{DD} = 60\text{ V}$	-	280		ns
Q_{rr}	Reverse recovery charge		-	2.7		μC
I_{RRM}	Reverse recovery current	(see Figure 16. Test circuit for inductive load switching and diode recovery times)	-	19.5		A
t_{rr}	Reverse recovery time	$I_{SD} = 11\text{ A}$, $di/dt = 100\text{ A}/\mu\text{s}$, $V_{DD} = 60\text{ V}$, $T_j = 150\text{ }^\circ\text{C}$	-	400		ns
Q_{rr}	Reverse recovery charge		-	3.8		μC
I_{RRM}	Reverse recovery current		(see Figure 16. Test circuit for inductive load switching and diode recovery times)	-	19	

1. Pulse width is limited by safe operating area.
2. Pulsed: pulse duration = 300 μs , duty cycle 1.5%

2.1 Electrical characteristics (curves)

Figure 1. Safe operating area

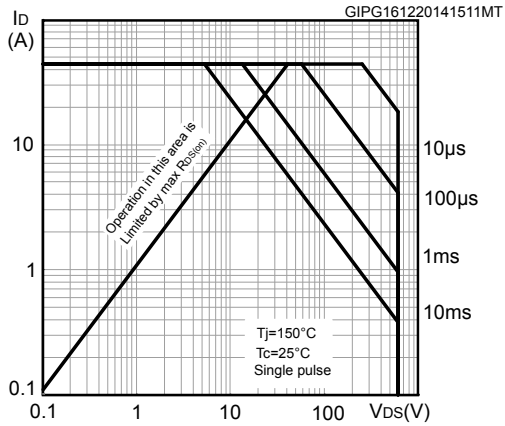

Figure 2. Thermal impedance

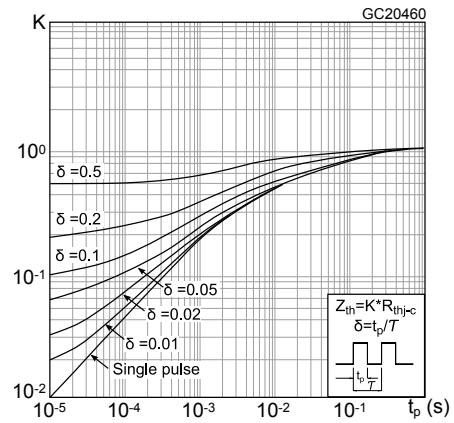

Figure 3. Output characteristics

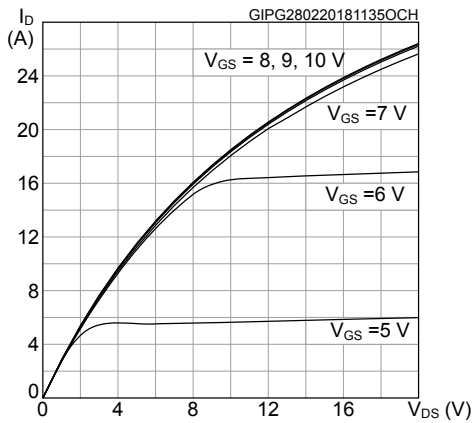

Figure 4. Transfer characteristics

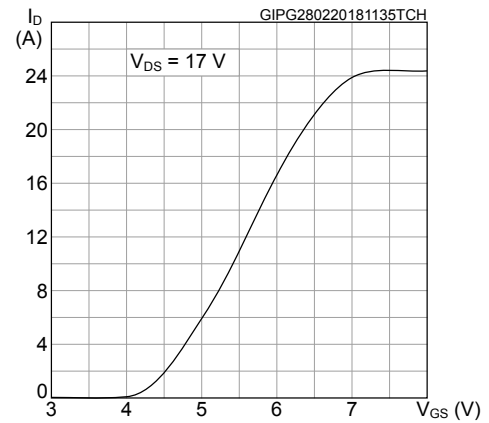

Figure 5. Normalized gate threshold voltage vs temperature

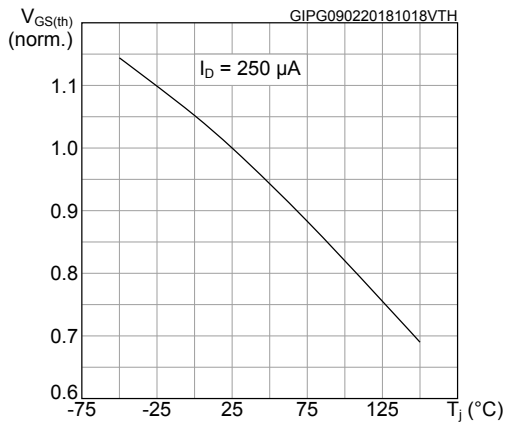

Figure 6. Normalized $V_{(BR)DSS}$ vs temperature

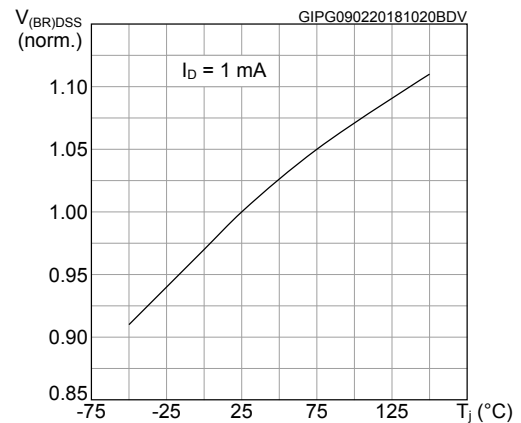

Figure 7. Static drain-source on-resistance

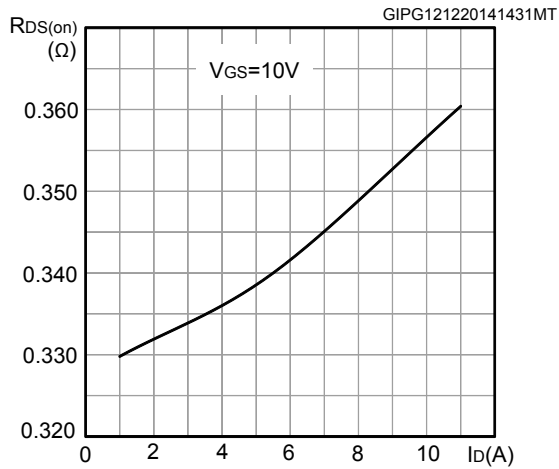

Figure 8. Normalized on-resistance vs temperature

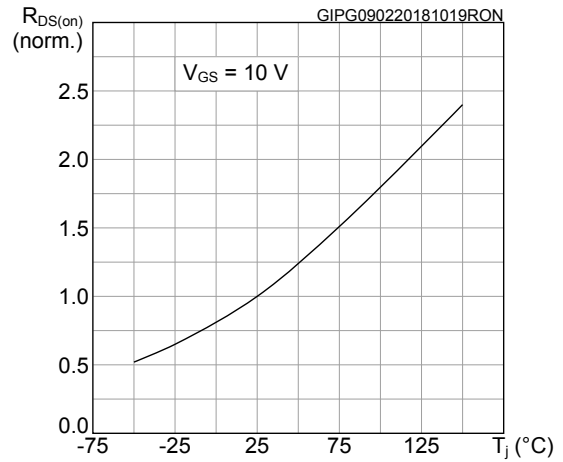

Figure 9. Gate charge vs gate-source voltage

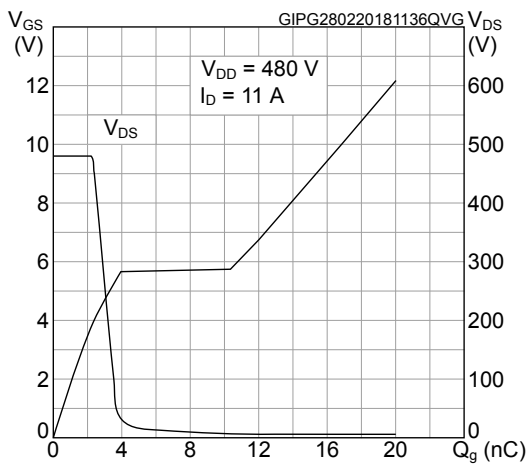

Figure 10. Capacitance variations

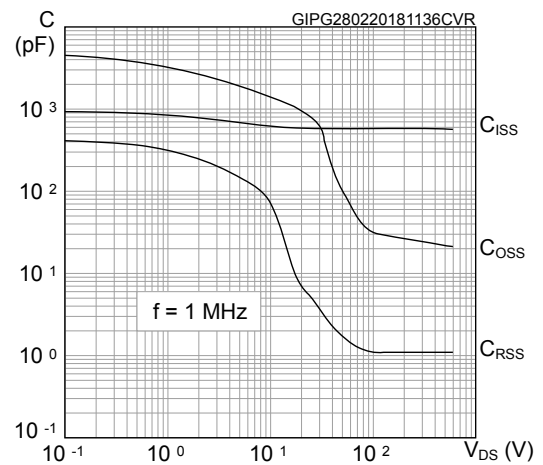

Figure 11. Turn-off switching energy vs drain current

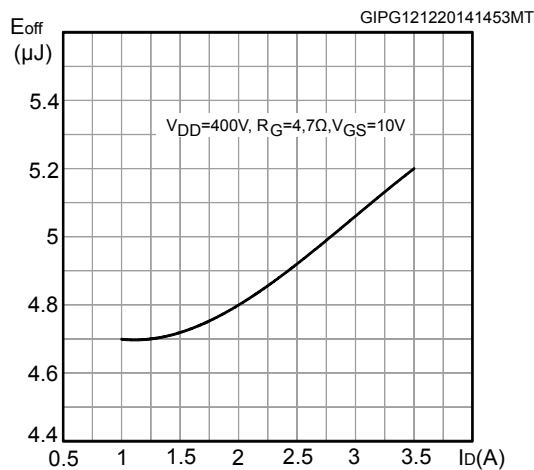

Figure 12. Source-drain diode forward characteristic

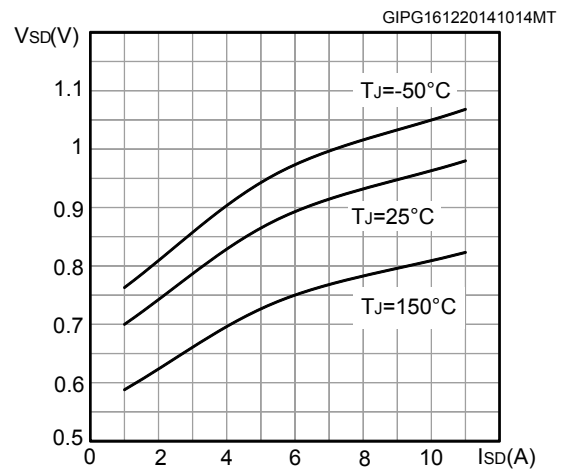
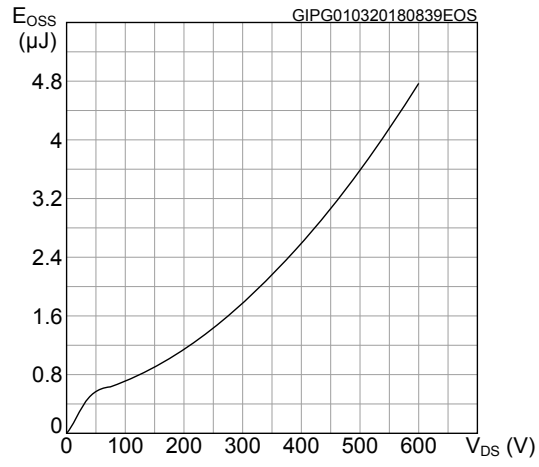
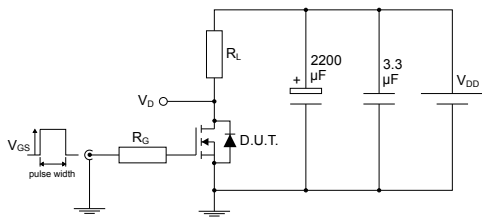

Figure 13. Output capacitance stored energy



3 Test circuits

Figure 14. Test circuit for resistive load switching times

AM01468v1

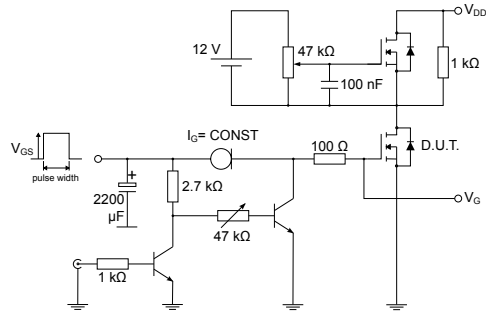
Figure 15. Test circuit for gate charge behavior

AM01469v1

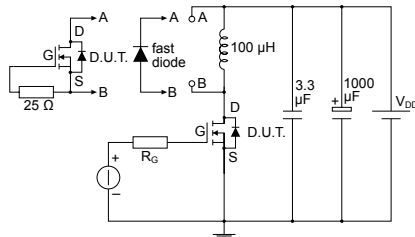
Figure 16. Test circuit for inductive load switching and diode recovery times

AM01470v1

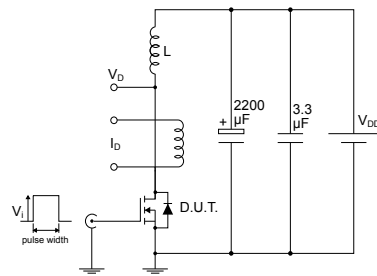
Figure 17. Unclamped inductive load test circuit

AM01471v1

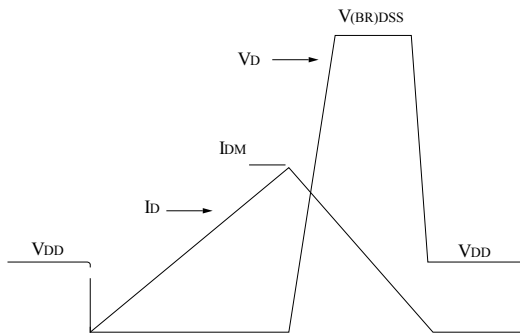
Figure 18. Unclamped inductive waveform

AM01472v1

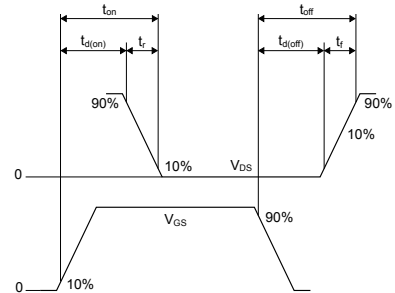
Figure 19. Switching time waveform

AM01473v1

4 Package mechanical data

In order to meet environmental requirements, ST offers these devices in different grades of ECOPACK® packages, depending on their level of environmental compliance. ECOPACK® specifications, grade definitions and product status are available at: www.st.com. ECOPACK® is an ST trademark.

4.1 DPAK (TO-252) type A

Figure 20. DPAK (TO-252) type A2 package outline

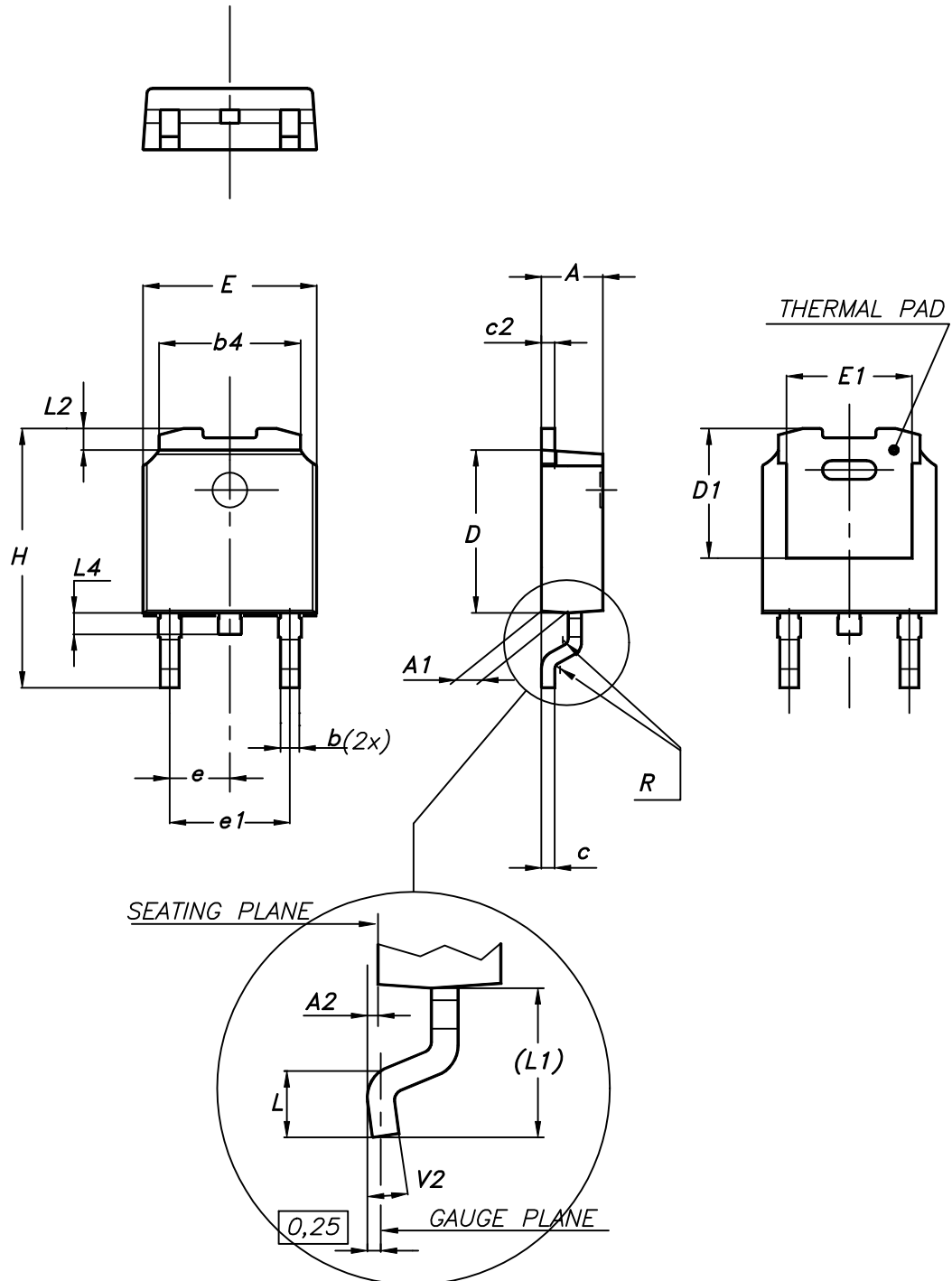

0068772_type-A2_rev25

Table 9. DPAK (TO-252) type A2 mechanical data

Dim.	mm		
	Min.	Typ.	Max.
A	2.20		2.40
A1	0.90		1.10
A2	0.03		0.23
b	0.64		0.90
b4	5.20		5.40
c	0.45		0.60
c2	0.48		0.60
D	6.00		6.20
D1	4.95	5.10	5.25
E	6.40		6.60
E1	5.10	5.20	5.30
e	2.159	2.286	2.413
e1	4.445	4.572	4.699
H	9.35		10.10
L	1.00		1.50
L1	2.60	2.80	3.00
L2	0.65	0.80	0.95
L4	0.60		1.00
R		0.20	
V2	0°		8°

Figure 21. DPAK (TO-252) recommended footprint (dimensions are in mm)

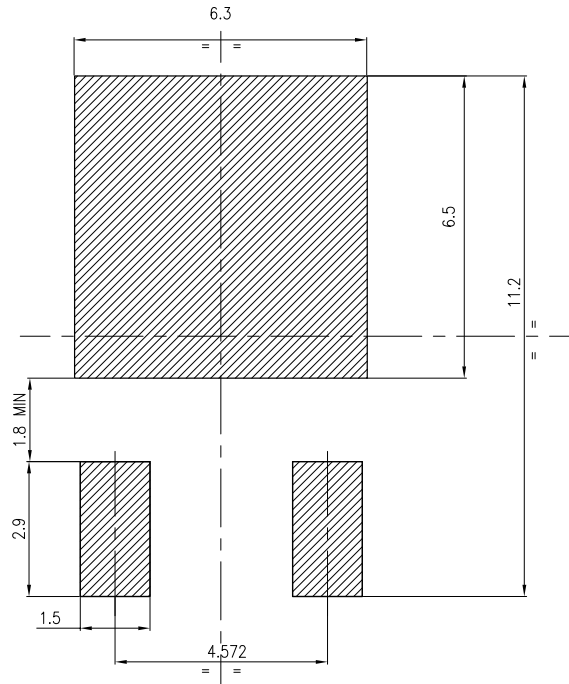

FP_0068772_25

4.2 DPAK (TO-252) packing information

Figure 22. DPAK (TO-252) tape outline

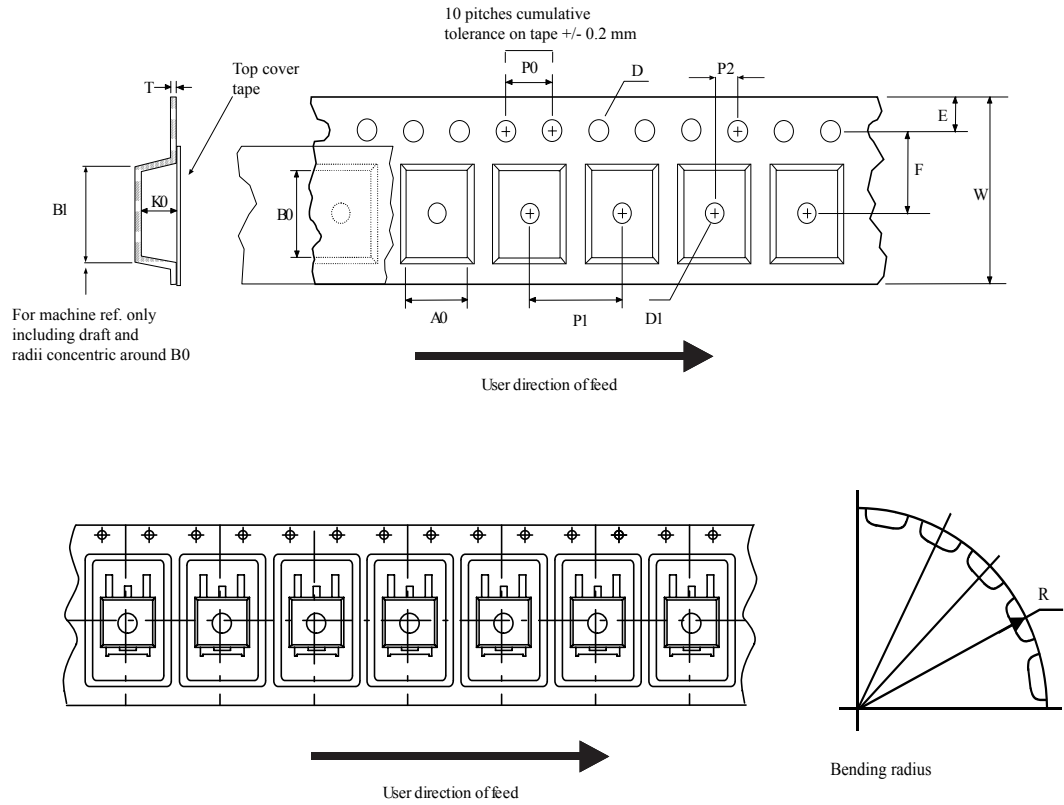

AM08852v1

Figure 23. DPAK (TO-252) reel outline

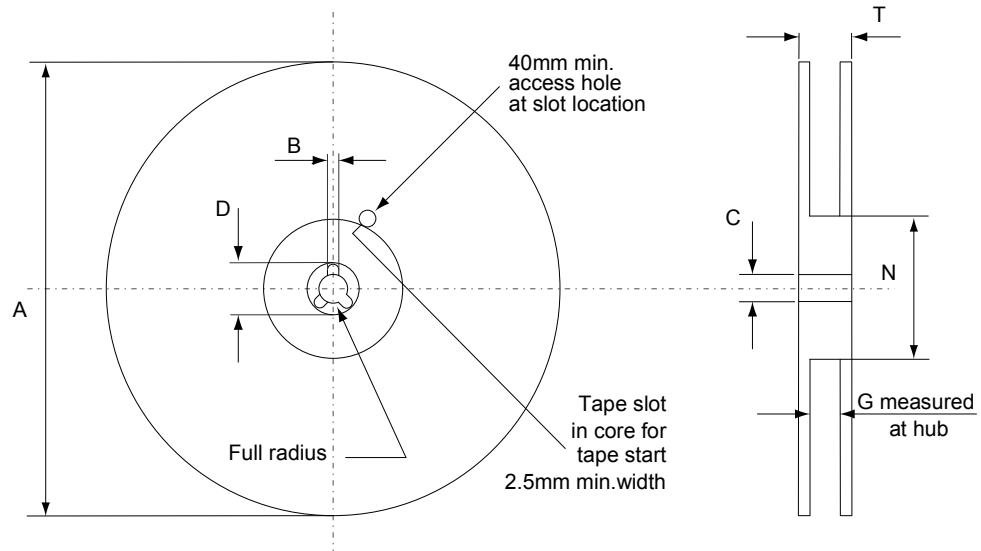

AM06038v1

Table 10. DPAK (TO-252) tape and reel mechanical data

Tape			Reel		
Dim.	mm		Dim.	mm	
	Min.	Max.		Min.	Max.
A0	6.8	7	A		330
B0	10.4	10.6	B	1.5	
B1		12.1	C	12.8	13.2
D	1.5	1.6	D	20.2	
D1	1.5		G	16.4	18.4
E	1.65	1.85	N	50	
F	7.4	7.6	T		22.4
K0	2.55	2.75			
P0	3.9	4.1	Base qty.		2500
P1	7.9	8.1	Bulk qty.		2500
P2	1.9	2.1			
R	40				
T	0.25	0.35			
W	15.7	16.3			

Revision history

Table 11. Document revision history

Date	Revision	Changes
11-May-2015	1	First release.
12-Mar-2018	2	Removed maturity status indication from cover page. The document status is production data. Updated <i>Section 1 Electrical ratings, Section 2 Electrical characteristics and Section 2.1 Electrical characteristics (curves)</i> . Updated <i>Section 4.1 DPAK (TO-252) type A2 package information</i> .
05-Jun-2018	3	Updated Table 1. Absolute maximum ratings , Table 5. Dynamic , Table 6. Switching energy and Table 8. Source drain diode . Updated Figure 1. Safe operating area and Figure 11. Turn-off switching energy vs drain current . Minor text changes

Contents

1	Electrical ratings	2
2	Electrical characteristics	3
2.1	Electrical characteristics (curves)	5
3	Test circuits	8
4	Package mechanical data	9
4.1	DPAK (TO-252) type A	9
4.2	DPAK (TO-252) packing information	12
	Revision history	15

IMPORTANT NOTICE – PLEASE READ CAREFULLY

STMicroelectronics NV and its subsidiaries (“ST”) reserve the right to make changes, corrections, enhancements, modifications, and improvements to ST products and/or to this document at any time without notice. Purchasers should obtain the latest relevant information on ST products before placing orders. ST products are sold pursuant to ST’s terms and conditions of sale in place at the time of order acknowledgement.

Purchasers are solely responsible for the choice, selection, and use of ST products and ST assumes no liability for application assistance or the design of Purchasers’ products.

No license, express or implied, to any intellectual property right is granted by ST herein.

Resale of ST products with provisions different from the information set forth herein shall void any warranty granted by ST for such product.

ST and the ST logo are trademarks of ST. All other product or service names are the property of their respective owners.

Information in this document supersedes and replaces information previously supplied in any prior versions of this document.

© 2018 STMicroelectronics – All rights reserved

X-ON Electronics

Largest Supplier of Electrical and Electronic Components

Click to view similar products for [MOSFET](#) category:

Click to view products by [STMicroelectronics](#) manufacturer:

Other Similar products are found below :

[614233C](#) [648584F](#) [IRFD120](#) [JANTX2N5237](#) [FCA20N60_F109](#) [FDZ595PZ](#) [2SK2545\(Q,T\)](#) [405094E](#) [423220D](#) [TPCC8103,L1Q\(CM](#)
[MIC4420CM-TR](#) [VN1206L](#) [SBVS138LT1G](#) [614234A](#) [715780A](#) [NTNS3166NZT5G](#) [SSM6J414TU,LF\(T](#) [751625C](#) [BUK954R8-60E](#)
[NTE6400](#) [SQJ402EP-T1-GE3](#) [2SK2614\(TE16L1,Q\)](#) [2N7002KW-FAI](#) [DMN1017UCP3-7](#) [EFC2J004NUZTDG](#) [ECH8691-TL-W](#)
[FCAB21350L1](#) [P85W28HP2F-7071](#) [DMN1053UCP4-7](#) [NTE221](#) [NTE2384](#) [NTE2903](#) [NTE2941](#) [NTE2945](#) [NTE2946](#) [NTE2960](#) [NTE2967](#)
[NTE2969](#) [NTE2976](#) [NTE455](#) [NTE6400A](#) [NTE2910](#) [NTE2916](#) [NTE2956](#) [NTE2911](#) [DMN2080UCB4-7](#) [TK10A80W,S4X\(S](#)
[SSM6P69NU,LF](#) [DMP22D4UFO-7B](#) [DMN1006UCA6-7](#)