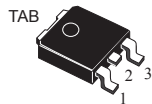
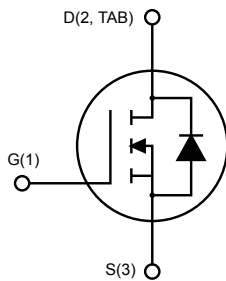

N-channel 100 V, 30 mΩ typ., 25 A, STripFET™ II Power MOSFET in a DPAK package

DPAK

AM01475v1_noZen

Features

Type	V _{DS}	R _{DS(on)} max.	I _D
STD25NF10LT4	100 V	35 mΩ	25 A

- Exceptional dv/dt capability
- 100% avalanche tested
- Low gate charge

Applications

- Switching applications

Description

This Power MOSFET series has been developed using STMicroelectronics' unique STripFET™ process, which is specifically designed to minimize input capacitance and gate charge. This renders the device suitable for use as primary switch in advanced high-efficiency isolated DC-DC converters for telecom and computer applications, and applications with low gate charge driving requirements.

Product status link

[STD25NF10LT4](#)

Product summary

Order code	STD25NF10LT4
Marking	D25NF10L
Package	DPAK
Packing	Tape and reel

1 Electrical ratings

Table 1. Absolute maximum ratings

Symbol	Parameter	Value	Unit
V_{DS}	Drain-source voltage	100	V
V_{DGR}	Gate-source voltage ($R_{GS} = 20\text{ k}\Omega$)	100	V
V_{GS}	Gate-source voltage	± 16	V
I_D	Drain current (continuous) at $T_C = 25\text{ }^\circ\text{C}$	25	A
	Drain current (continuous) at $T_C = 100\text{ }^\circ\text{C}$	21	A
$I_{DM}^{(1)}$	Drain current (pulsed)	100	A
P_{TOT}	Total dissipation at $T_C = 25\text{ }^\circ\text{C}$	100	W
$E_{AS}^{(2)}$	Single-pulse avalanche energy	450	mJ
$dv/dt^{(3)}$	Peak diode recovery voltage slope	20	V/ns
T_{stg}	Storage temperature range	-55 to 175	$^\circ\text{C}$
T_j	Operating junction temperature range		

1. Pulse width limited by safe operating area.
2. Starting $T_J = 25\text{ }^\circ\text{C}$, $I_D = 12.5\text{ A}$, $V_{DD} = 50\text{ V}$
3. $I_{SD} \leq 25\text{ A}$, $di/dt \leq 300\text{ A}/\mu\text{s}$, $V_{DS} \leq V_{(BR)DSS}$, $T_J \leq T_{JMAX}$

Table 2. Thermal data

Symbol	Parameter	Value	Unit
$R_{thj-case}$	Thermal resistance junction-case	1.5	$^\circ\text{C}/\text{W}$
$R_{thj-pcb}^{(1)}$	Thermal resistance junction-pcb	50	$^\circ\text{C}/\text{W}$

1. When mounted on an FR-4 board of 1 inch², 2 oz Cu.

2 Electrical characteristics

$T_{CASE} = 25\text{ °C}$ unless otherwise specified

Table 3. On/off states

Symbol	Parameter	Test conditions	Min.	Typ.	Max.	Unit
$V_{(BR)DSS}$	Drain-source breakdown voltage	$V_{GS} = 0\text{ V}$, $I_D = 250\text{ }\mu\text{A}$	100			V
I_{DSS}	Zero gate voltage drain current	$V_{GS} = 0\text{ V}$, $V_{DS} = 100\text{ V}$			1	μA
		$V_{GS} = 0\text{ V}$, $V_{DS} = 100\text{ V}$, $T_C = 125\text{ °C}^{(1)}$			10	μA
I_{GSS}	Gate body leakage current	$V_{DS} = 0\text{ V}$, $V_{GS} = \pm 16\text{ V}$			± 100	nA
$V_{GS(th)}$	Gate threshold voltage	$V_{DD} = V_{GS}$, $I_D = 250\text{ }\mu\text{A}$	1		2.5	V
$R_{DS(on)}$	Static drain-source on-resistance	$V_{GS} = 10\text{ V}$, $I_D = 12.5\text{ A}$		30	35	m Ω
		$V_{GS} = 4.5\text{ V}$, $I_D = 12.5\text{ A}$		35	40	m Ω

1. Defined by design, not subject to production test.

Table 4. Dynamic

Symbol	Parameter	Test conditions	Min.	Typ.	Max.	Unit
C_{iss}	Input capacitance	$V_{DS} = 25\text{ V}$, $f = 1\text{ MHz}$, $V_{GS} = 0\text{ V}$	-	1710		pF
C_{oss}	Output capacitance		-	250		pF
C_{rss}	Reverse transfer capacitance		-	110		pF
Q_g	Total gate charge	$V_{DD} = 80\text{ V}$, $I_D = 25\text{ A}$, $V_{GS} = 0\text{ to }5\text{ V}$ (see Figure 13. Test circuit for gate charge behavior)	-	38	52	nC
Q_{gs}	Gate-source charge		-	8.5		nC
Q_{gd}	Gate-drain charge		-	21		nC

Table 5. Switching times

Symbol	Parameter	Test conditions	Min.	Typ.	Max.	Unit
$t_{d(on)}$	Turn-on delay time	$V_{DD} = 50\text{ V}$, $I_D = 12.5\text{ A}$, $R_G = 4.7\text{ }\Omega$, $V_{GS} = 5\text{ V}$ (see Figure 12. Test circuit for resistive load switching times and Figure 17. Switching time waveform)	-	20	-	ns
t_r	Rise time		-	40	-	ns
$t_{d(off)}$	Turn-off delay time		-	58	-	ns
t_f	Fall time		-	20	-	ns

Table 6. Source-drain diode

Symbol	Parameter	Test conditions	Min.	Typ.	Max.	Unit
I_{SD}	Source-drain current		-		25	A
$I_{SDM}^{(1)}$	Source-drain current (pulsed)		-		100	A

Symbol	Parameter	Test conditions	Min.	Typ.	Max.	Unit
$V_{SD}^{(2)}$	Forward on voltage	$I_{SD} = 25 \text{ A}$, $V_{GS} = 0 \text{ V}$	-		1.5	V
t_{rr}	Reverse recovery time	$I_{SD} = 25 \text{ A}$, $di/dt = 100 \text{ A}/\mu\text{s}$,	-	88		ns
Q_{rr}	Reverse recovery charge	$V_{DD} = 50 \text{ V}$, $T_J = 150 \text{ }^\circ\text{C}$	-	317		nC
I_{RRM}	Reverse recovery current	(see Figure 17. Switching time waveform)	-	7.2		A

1. Pulse width limited by safe operating area
2. Pulsed: pulse duration = 300 μs , duty cycle 1.5%

2.1 Electrical characteristics (curves)

Figure 1. Safe operating area

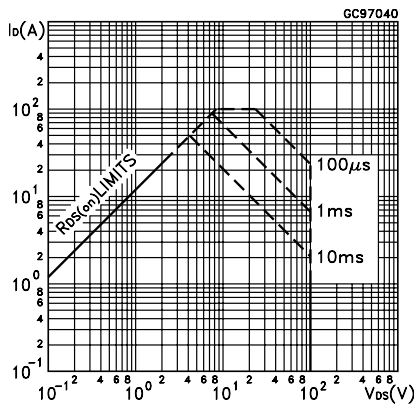

Figure 2. Thermal impedance

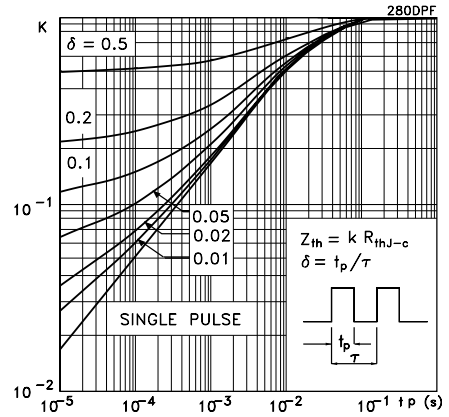

Figure 3. Output characteristics

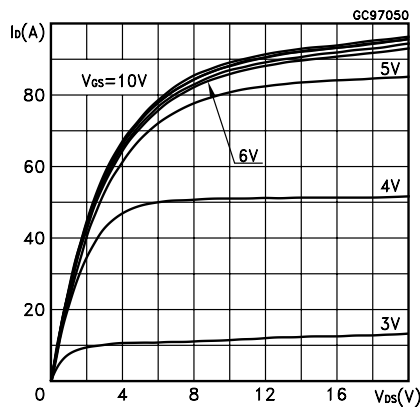

Figure 4. Transfer characteristics

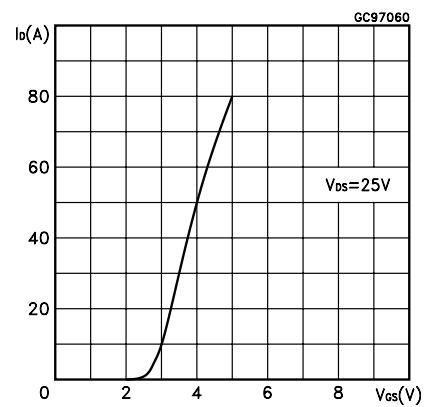

Figure 5. Gate charge vs gate-source voltage

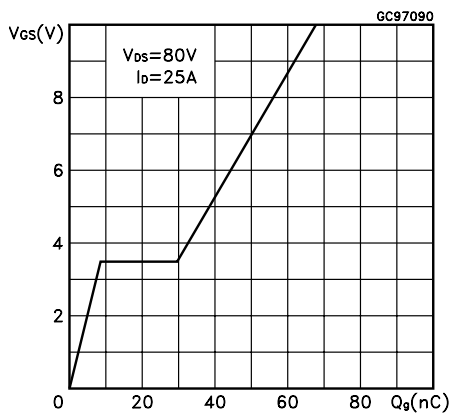

Figure 6. Static drain-source on-resistance

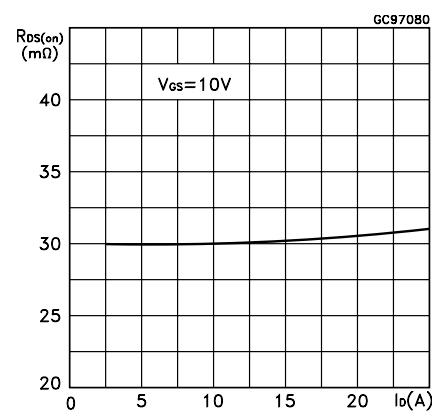

Figure 7. Capacitance variations

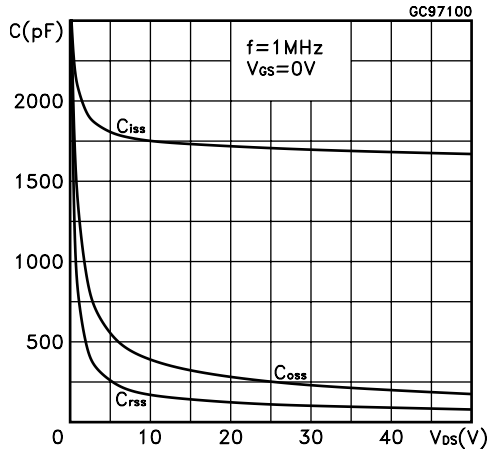

Figure 8. Normalized gate threshold voltage vs temperature

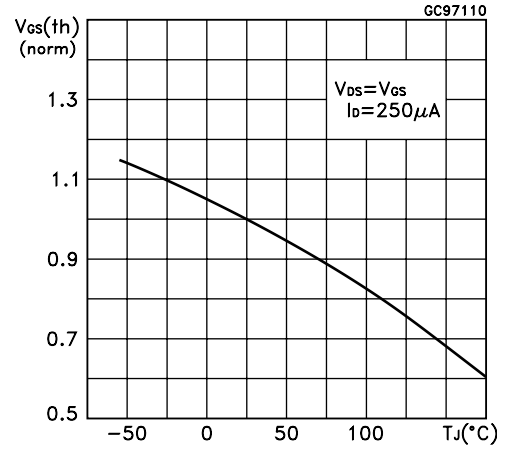

Figure 9. Normalized on-resistance vs temperature

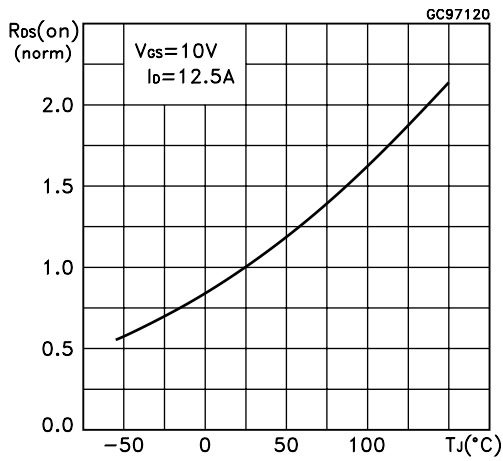

Figure 10. Source-drain diode forward characteristics

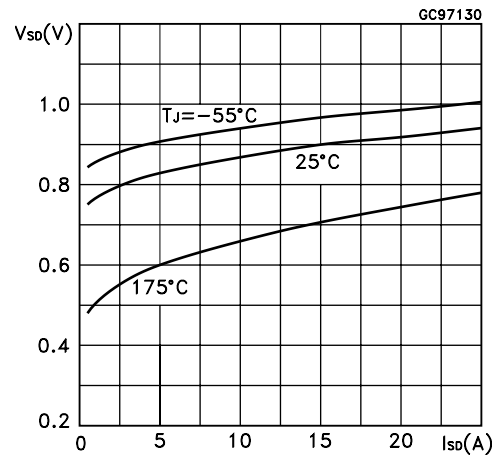
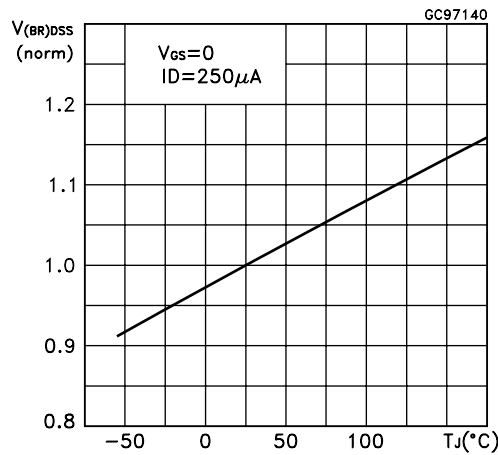
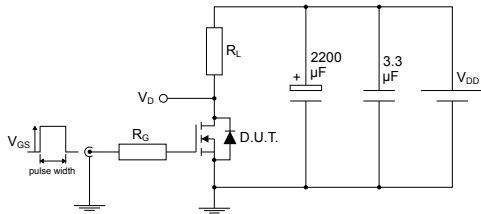

Figure 11. Normalized $V_{(BR)DSS}$ vs temperature



3 Test circuits

Figure 12. Test circuit for resistive load switching times

AM01468v1

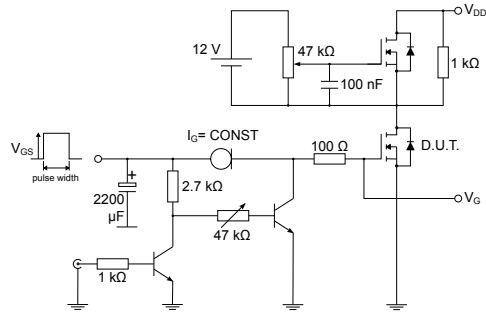
Figure 13. Test circuit for gate charge behavior

AM01469v1

Figure 14. Test circuit for inductive load switching and diode recovery times



AM01470v1

Figure 15. Unclamped inductive load test circuit

AM01471v1

Figure 16. Unclamped inductive waveform

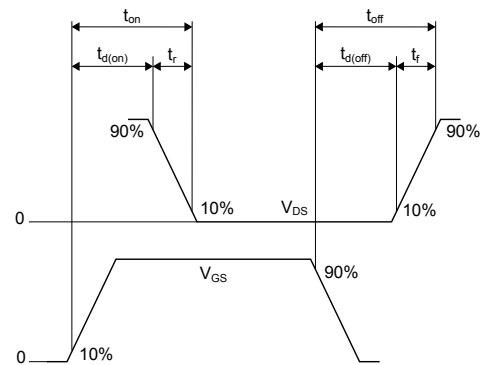
AM01472v1

Figure 17. Switching time waveform

AM01473v1

4 Package information

In order to meet environmental requirements, ST offers these devices in different grades of ECOPACK® packages, depending on their level of environmental compliance. ECOPACK® specifications, grade definitions and product status are available at: www.st.com. ECOPACK® is an ST trademark.

4.1 DPAK (TO-252) type A package information

Figure 18. DPAK (TO-252) type A package outline

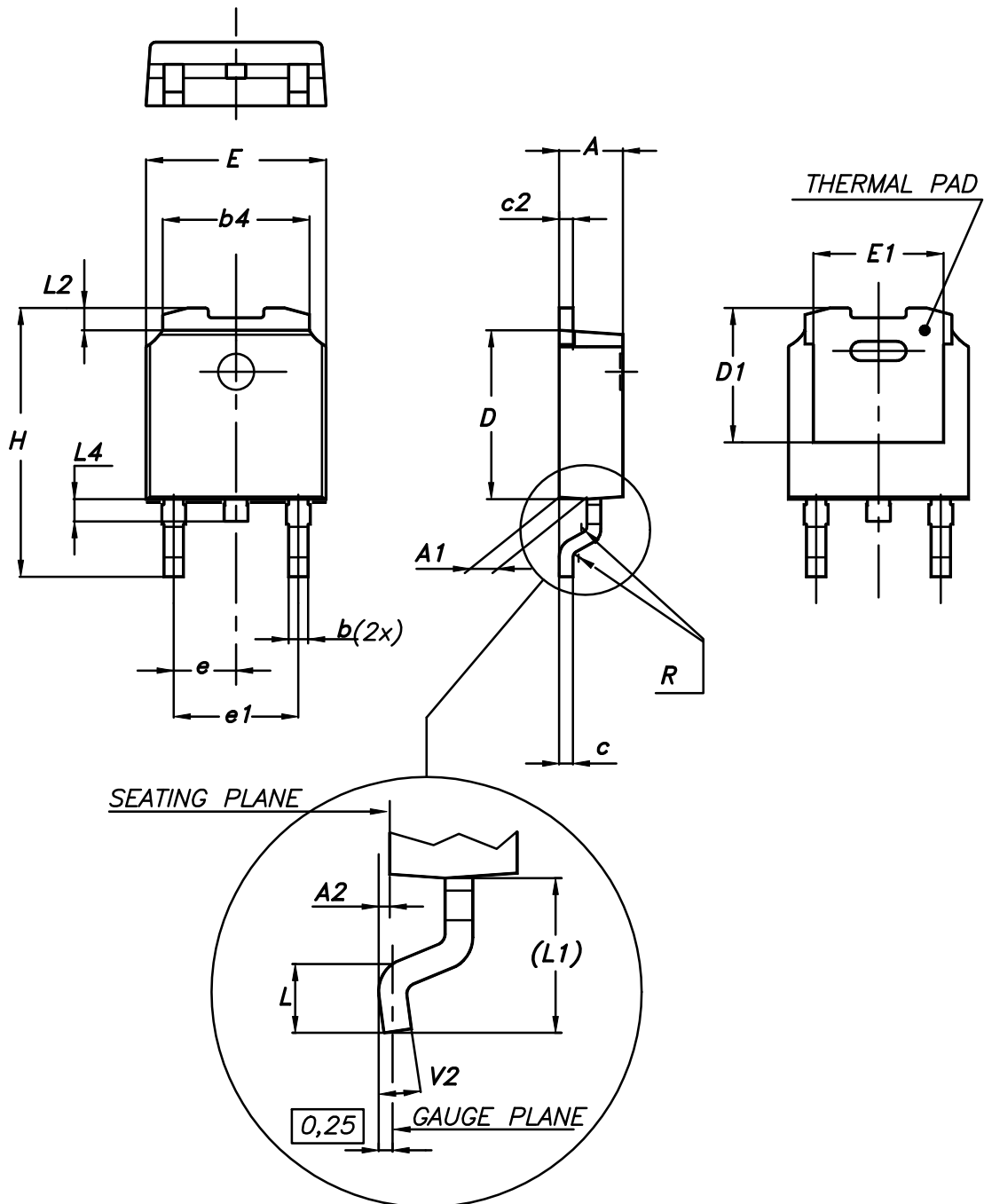

0068772_A_25

Table 7. DPAK (TO-252) type A mechanical data

Dim.	mm		
	Min.	Typ.	Max.
A	2.20		2.40
A1	0.90		1.10
A2	0.03		0.23
b	0.64		0.90
b4	5.20		5.40
c	0.45		0.60
c2	0.48		0.60
D	6.00		6.20
D1	4.95	5.10	5.25
E	6.40		6.60
E1	4.60	4.70	4.80
e	2.159	2.286	2.413
e1	4.445	4.572	4.699
H	9.35		10.10
L	1.00		1.50
(L1)	2.60	2.80	3.00
L2	0.65	0.80	0.95
L4	0.60		1.00
R		0.20	
V2	0°		8°

4.2 DPAK (TO-252) type C2 package information

Figure 19. DPAK (TO-252) type C2 package outline

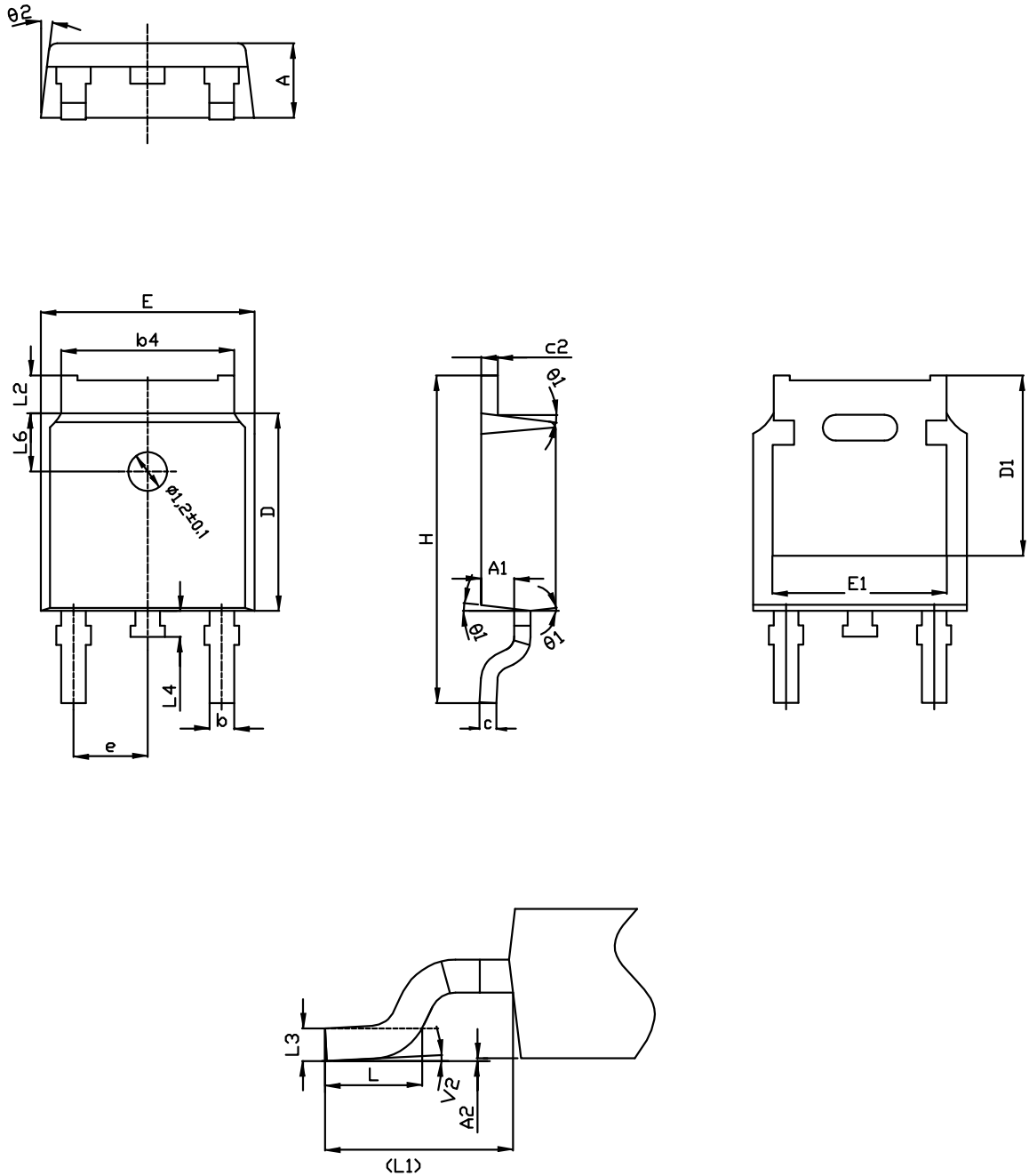

0068772_C2_25

Table 8. DPAK (TO-252) type C2 mechanical data

Dim.	mm		
	Min.	Typ.	Max.
A	2.20	2.30	2.38
A1	0.90	1.01	1.10
A2	0.00		0.10
b	0.72		0.85
b4	5.13	5.33	5.46
c	0.47		0.60
c2	0.47		0.60
D	6.00	6.10	6.20
D1	5.10		5.60
E	6.50	6.60	6.70
E1	5.20		5.50
e	2.186	2.286	2.386
H	9.80	10.10	10.40
L	1.40	1.50	1.70
L1	2.90 REF		
L2	0.90		1.25
L3	0.51 BSC		
L4	0.60	0.80	1.00
L6	1.80 BSC		
θ1	5°	7°	9°
θ2	5°	7°	9°
V2	0°		8°

Figure 20. DPAK (TO-252) recommended footprint (dimensions are in mm)

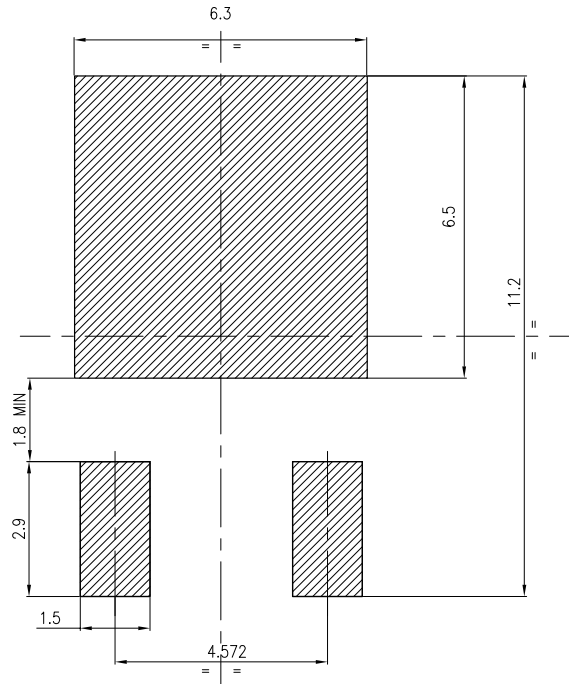

FP_0068772_25

4.3 DPAK (TO-252) packing information

Figure 21. DPAK (TO-252) tape outline

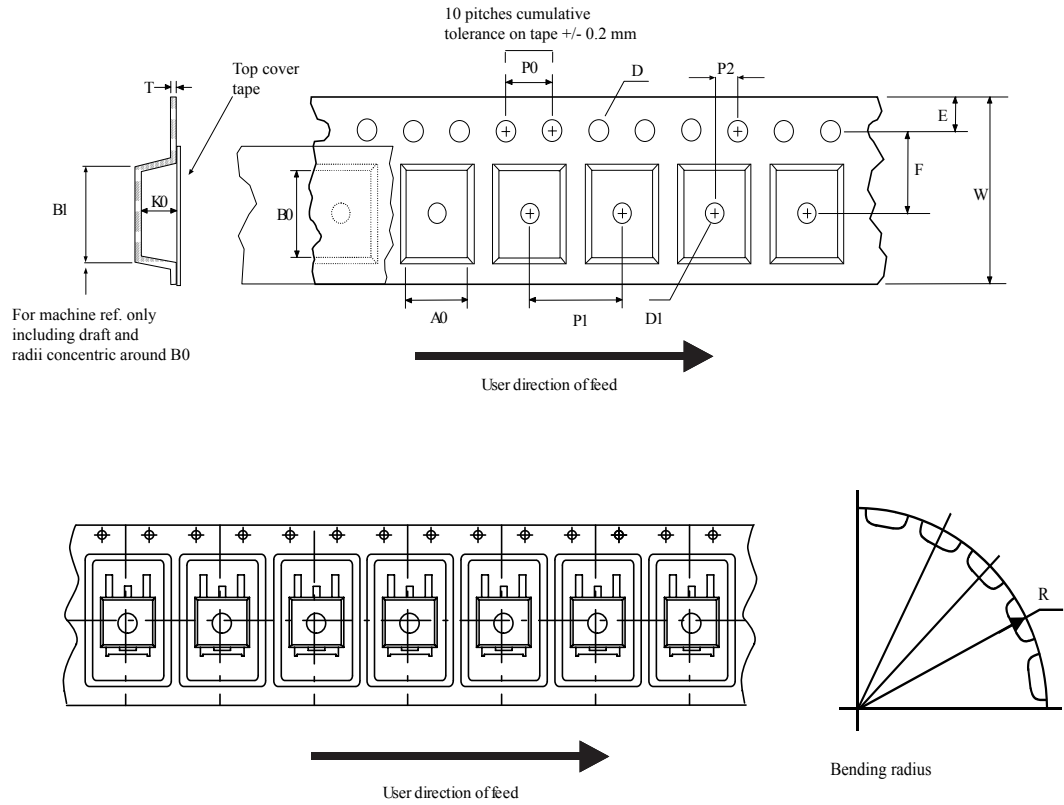

AM08852v1

Figure 22. DPAK (TO-252) reel outline

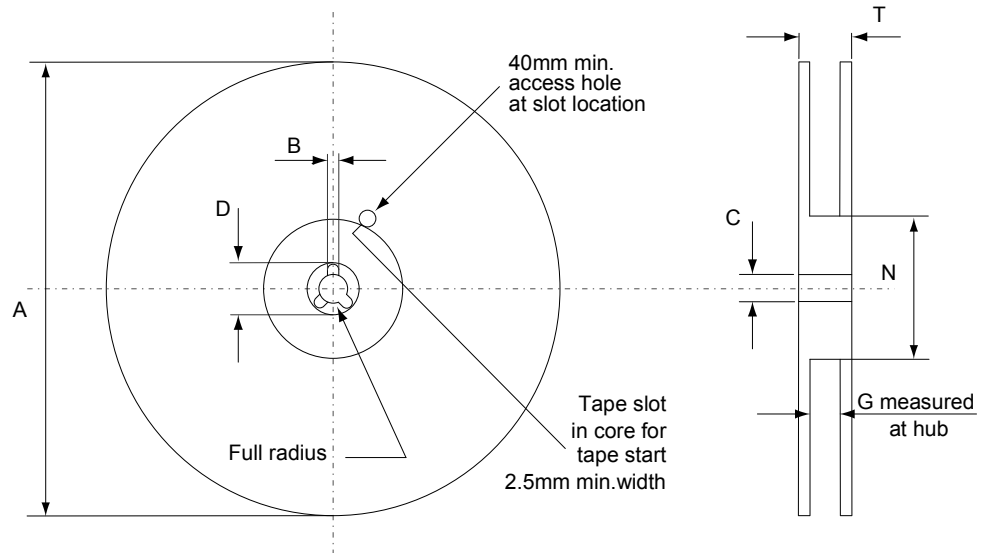

AM06038v1

Table 9. DPAK (TO-252) tape and reel mechanical data

Tape			Reel		
Dim.	mm		Dim.	mm	
	Min.	Max.		Min.	Max.
A0	6.8	7	A		330
B0	10.4	10.6	B	1.5	
B1		12.1	C	12.8	13.2
D	1.5	1.6	D	20.2	
D1	1.5		G	16.4	18.4
E	1.65	1.85	N	50	
F	7.4	7.6	T		22.4
K0	2.55	2.75			
P0	3.9	4.1	Base qty.		2500
P1	7.9	8.1	Bulk qty.		2500
P2	1.9	2.1			
R	40				
T	0.25	0.35			
W	15.7	16.3			

Revision history

Table 10. Document revision history

Date	Version	Changes
21-Jun-2004	3	Preliminary version
03-Jun-2006	4	New template, no content change
09-Aug-2018	5	Updated information on cover page. Updated Section 4 Package information . Minor text changes

Contents

1	Electrical ratings	2
2	Electrical characteristics	3
2.1	Electrical characteristics (curves)	5
3	Test circuits	7
4	Package information	8
4.1	DPAK (TO-252) type A package information	8
4.2	DPAK (TO-252) type C2 package information	10
4.3	DPAK (TO-252) packing information	13
	Revision history	16

IMPORTANT NOTICE – PLEASE READ CAREFULLY

STMicroelectronics NV and its subsidiaries (“ST”) reserve the right to make changes, corrections, enhancements, modifications, and improvements to ST products and/or to this document at any time without notice. Purchasers should obtain the latest relevant information on ST products before placing orders. ST products are sold pursuant to ST’s terms and conditions of sale in place at the time of order acknowledgement.

Purchasers are solely responsible for the choice, selection, and use of ST products and ST assumes no liability for application assistance or the design of Purchasers’ products.

No license, express or implied, to any intellectual property right is granted by ST herein.

Resale of ST products with provisions different from the information set forth herein shall void any warranty granted by ST for such product.

ST and the ST logo are trademarks of ST. All other product or service names are the property of their respective owners.

Information in this document supersedes and replaces information previously supplied in any prior versions of this document.

© 2018 STMicroelectronics – All rights reserved

X-ON Electronics

Largest Supplier of Electrical and Electronic Components

Click to view similar products for [MOSFET](#) category:

Click to view products by [STMicroelectronics](#) manufacturer:

Other Similar products are found below :

[614233C](#) [648584F](#) [IRFD120](#) [JANTX2N5237](#) [FCA20N60_F109](#) [FDZ595PZ](#) [2SK2545\(Q,T\)](#) [405094E](#) [423220D](#) [TPCC8103,L1Q\(CM](#)
[MIC4420CM-TR](#) [VN1206L](#) [SBVS138LT1G](#) [614234A](#) [715780A](#) [NTNS3166NZT5G](#) [SSM6J414TU,LF\(T](#) [751625C](#) [BUK954R8-60E](#)
[DMN3404LQ-7](#) [NTE6400](#) [SQJ402EP-T1-GE3](#) [2SK2614\(TE16L1,Q\)](#) [2N7002KW-FAI](#) [DMN1017UCP3-7](#) [EFC2J004NUZTDG](#) [ECH8691-](#)
[TL-W](#) [FCAB21350L1](#) [P85W28HP2F-7071](#) [DMN1053UCP4-7](#) [NTE221](#) [NTE2384](#) [NTE2903](#) [NTE2941](#) [NTE2945](#) [NTE2946](#) [NTE2960](#)
[NTE2967](#) [NTE2969](#) [NTE2976](#) [NTE455](#) [NTE6400A](#) [NTE2910](#) [NTE2916](#) [NTE2956](#) [NTE2911](#) [DMN2080UCB4-7](#) [TK10A80W,S4X\(S](#)
[SSM6P69NU,LF](#) [DMP22D4UFO-7B](#)