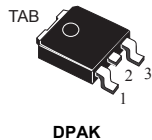
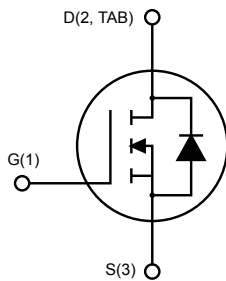

## N-channel 100 V, 33 mΩ typ., 25 A, STripFET™ II Power MOSFET in a DPAK package

**DPAK**

AM01475v1\_noZen

### Features

Type	V <sub>DS</sub>	R <sub>DS(on)</sub> max.	I <sub>D</sub>
STD25NF10T4	100 V	38 mΩ	25 A

- Exceptional dv/dt capability
- 100% avalanche tested
- Low gate charge

### Applications

- Switching applications

### Description

This Power MOSFET series has been developed using STMicroelectronics' unique STripFET™ process, which is specifically designed to minimize input capacitance and gate charge. This renders the device suitable for use as primary switch in advanced high-efficiency isolated DC-DC converters for telecom and computer applications, and applications with low gate charge driving requirements.

#### Product status link

[STD25NF10T4](#)

#### Product summary

<b>Order code</b>	STD25NF10T4
<b>Marking</b>	D25NF10
<b>Package</b>	DPAK
<b>Packing</b>	Tape and reel

# 1 Electrical ratings

**Table 1. Absolute maximum ratings**

Symbol	Parameter	Value	Unit
$V_{DS}$	Drain-source voltage	100	V
$V_{DGR}$	Gate-source voltage ( $R_{GS} = 20\text{ k}\Omega$ )	100	V
$V_{GS}$	Gate-source voltage	$\pm 20$	V
$I_D$	Drain current (continuous) at $T_C = 25\text{ }^\circ\text{C}$	25	A
	Drain current (continuous) at $T_C = 100\text{ }^\circ\text{C}$	21	A
$I_{DM}^{(1)}$	Drain current (pulsed)	100	A
$P_{TOT}$	Total dissipation at $T_C = 25\text{ }^\circ\text{C}$	100	W
$E_{AS}^{(2)}$	Single-pulse avalanche energy	480	mJ
$dv/dt^{(3)}$	Peak diode recovery voltage slope	13	V/ns
$T_{stg}$	Storage temperature range	-55 to 175	$^\circ\text{C}$
$T_j$	Operating junction temperature range		

1. Pulse width limited by safe operating area.
2. Starting  $T_J = 25\text{ }^\circ\text{C}$ ,  $I_D = 12.5\text{ A}$ ,  $V_{DD} = 50\text{ V}$
3.  $I_{SD} \leq 25\text{ A}$ ,  $di/dt \leq 300\text{ A}/\mu\text{s}$ ,  $V_{DS} \leq V_{(BR)DSS}$ ,  $T_J \leq T_{JMAX}$

**Table 2. Thermal data**

Symbol	Parameter	Value	Unit
$R_{thj-case}$	Thermal resistance junction-case	1.5	$^\circ\text{C}/\text{W}$
$R_{thj-pcb}^{(1)}$	Thermal resistance junction-pcb	50	$^\circ\text{C}/\text{W}$

1. When mounted on an FR-4 board of 1 inch<sup>2</sup>, 2 oz Cu.

## 2 Electrical characteristics

$T_{CASE} = 25\text{ °C}$  unless otherwise specified

**Table 3. On/off states**

Symbol	Parameter	Test conditions	Min.	Typ.	Max.	Unit
$V_{(BR)DSS}$	Drain-source breakdown voltage	$V_{GS} = 0\text{ V}$ , $I_D = 250\text{ }\mu\text{A}$	100			V
$I_{DSS}$	Zero gate voltage drain current	$V_{GS} = 0\text{ V}$ , $V_{DS} = 100\text{ V}$			1	$\mu\text{A}$
		$V_{GS} = 0\text{ V}$ , $V_{DS} = 100\text{ V}$ , $T_C = 125\text{ °C}^{(1)}$			10	$\mu\text{A}$
$I_{GSS}$	Gate body leakage current	$V_{DS} = 0\text{ V}$ , $V_{GS} = \pm 20\text{ V}$			$\pm 100$	nA
$V_{GS(th)}$	Gate threshold voltage	$V_{DD} = V_{GS}$ , $I_D = 250\text{ }\mu\text{A}$	2	3	4	V
$R_{DS(on)}$	Static drain-source on-resistance	$V_{GS} = 10\text{ V}$ , $I_D = 12.5\text{ A}$		33	38	m $\Omega$

1. Defined by design, not subject to production test.

**Table 4. Dynamic**

Symbol	Parameter	Test conditions	Min.	Typ.	Max.	Unit
$C_{iss}$	Input capacitance	$V_{DS} = 25\text{ V}$ , $f = 1\text{ MHz}$ , $V_{GS} = 0\text{ V}$	-	1550	-	pF
$C_{oss}$	Output capacitance		-	220	-	pF
$C_{rss}$	Reverse transfer capacitance		-	95	-	pF
$Q_g$	Total gate charge	$V_{DD} = 80\text{ V}$ , $I_D = 25\text{ A}$ , $V_{GS} = 0\text{ to }10\text{ V}$	-	55	-	nC
$Q_{gs}$	Gate-source charge		-	12	-	nC
$Q_{gd}$	Gate-drain charge		(see Figure 12. Test circuit for gate charge behavior)	-	20	-

**Table 5. Switching times**

Symbol	Parameter	Test conditions	Min.	Typ.	Max.	Unit
$t_{d(on)}$	Turn-on delay time	$V_{DD} = 50\text{ V}$ , $I_D = 12.5\text{ A}$ , $R_G = 4.7\text{ }\Omega$ , $V_{GS} = 10\text{ V}$	-	17	-	ns
$t_r$	Rise time		-	60	-	ns
$t_{d(off)}$	Turn-off delay time	(see Figure 11. Test circuit for resistive load switching times and Figure 16. Switching time waveform)	-	60	-	ns
$t_f$	Fall time		-	15	-	ns

**Table 6. Source-drain diode**

Symbol	Parameter	Test conditions	Min.	Typ.	Max.	Unit
$I_{SD}$	Source-drain current		-		25	A
$I_{SDM}^{(1)}$	Source-drain current (pulsed)		-		100	A
$V_{SD}^{(2)}$	Forward on voltage	$I_{SD} = 25\text{ A}$ , $V_{GS} = 0\text{ V}$	-		1.5	V

Symbol	Parameter	Test conditions	Min.	Typ.	Max.	Unit
$t_{rr}$	Reverse recovery time	$I_{SD} = 25 \text{ A}$ , $di/dt = 100 \text{ A}/\mu\text{s}$ , $V_{DD} = 50 \text{ V}$ , $T_J = 150 \text{ }^\circ\text{C}$ (see <a href="#">Figure 16. Switching time waveform</a> )	-	88		ns
$Q_{rr}$	Reverse recovery charge		-	317		nC
$I_{RRM}$	Reverse recovery current		-	7.2		A

1. Pulse width limited by safe operating area
2. Pulsed: pulse duration = 300  $\mu\text{s}$ , duty cycle 1.5%

## 2.1 Electrical characteristics (curves)

Figure 1. Safe operating area

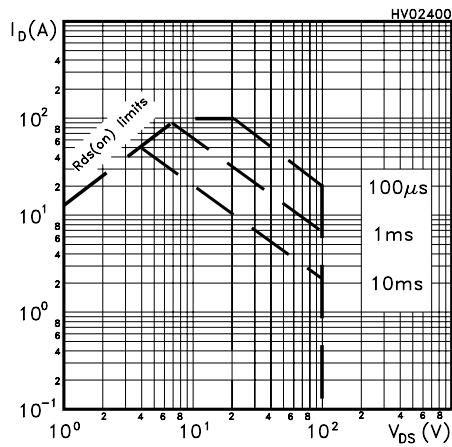

Figure 2. Thermal impedance

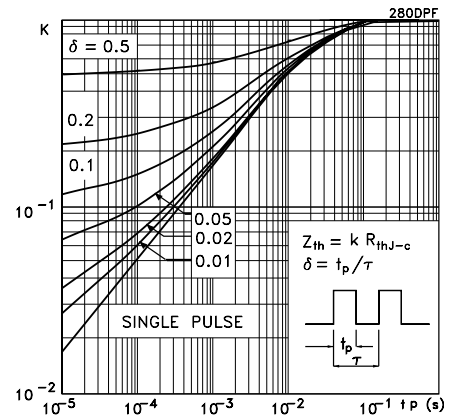

Figure 3. Output characteristics

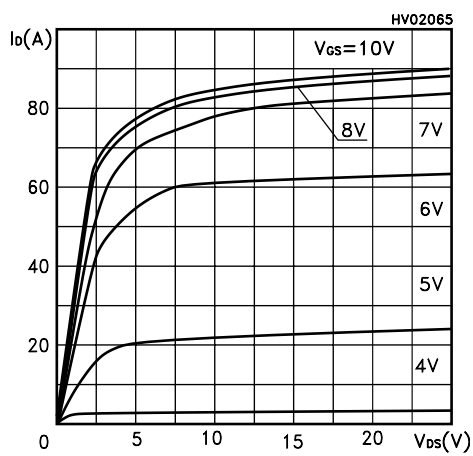

Figure 4. Transfer characteristics

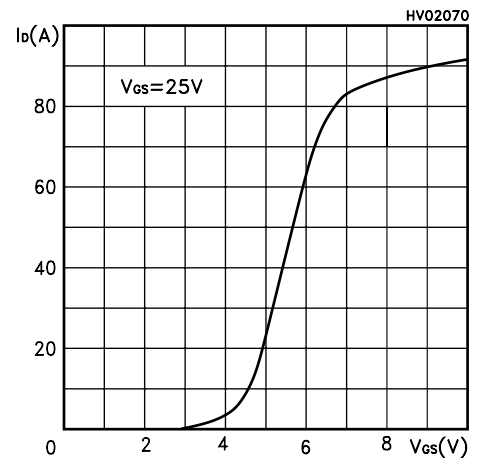

Figure 5. Gate charge vs gate-source voltage

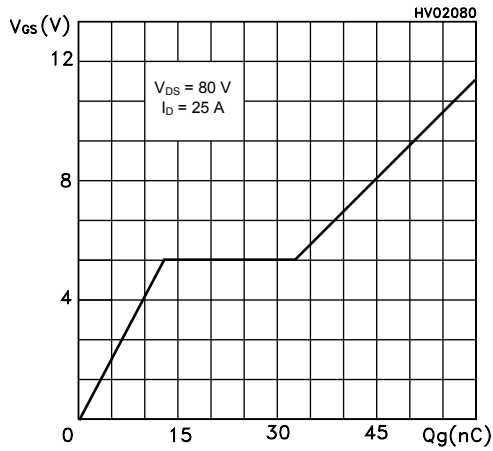

Figure 6. Static drain-source on-resistance

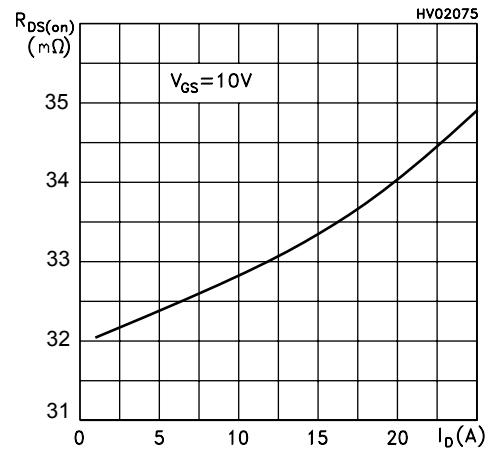

Figure 7. Source-drain diode forward characteristics

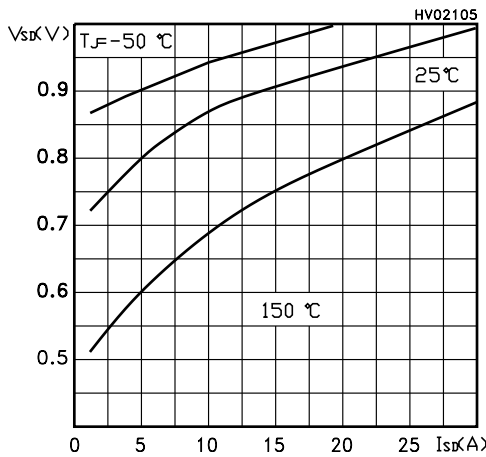

Figure 8. Capacitance variations

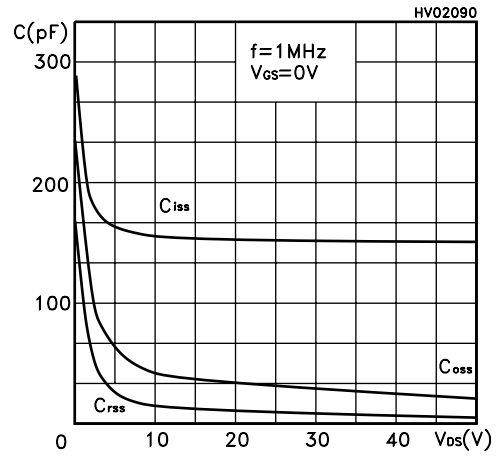

Figure 9. Normalized gate threshold voltage vs temperature

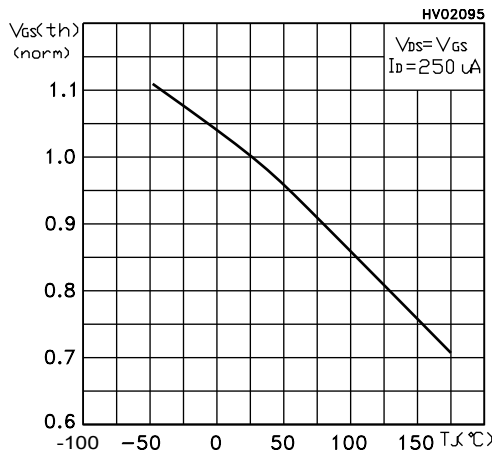
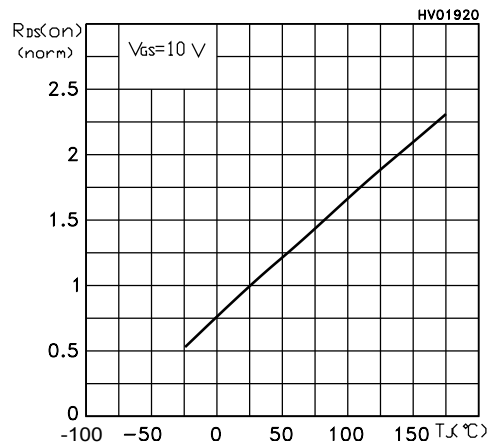
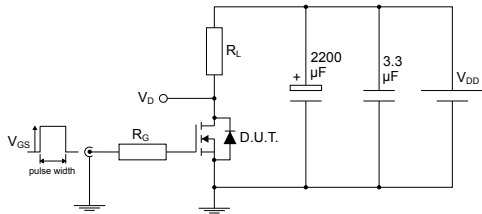

Figure 10. Normalized on-resistance vs temperature



### 3 Test circuits

**Figure 11. Test circuit for resistive load switching times**

AM01468v1

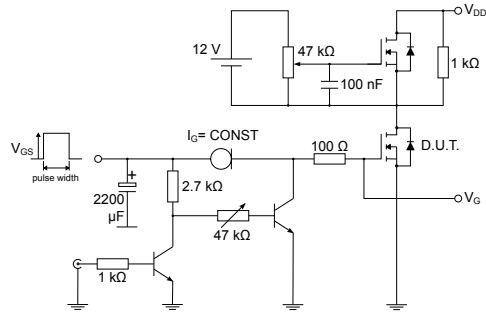
**Figure 12. Test circuit for gate charge behavior**

AM01469v1

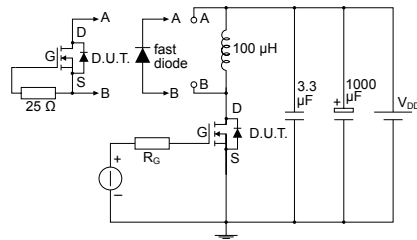
**Figure 13. Test circuit for inductive load switching and diode recovery times**

AM01470v1

**Figure 14. Unclamped inductive load test circuit**

AM01471v1

**Figure 15. Unclamped inductive waveform**

AM01472v1

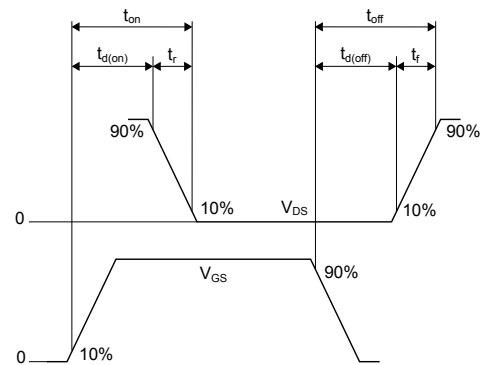
**Figure 16. Switching time waveform**

AM01473v1

## 4 Package information

---

In order to meet environmental requirements, ST offers these devices in different grades of ECOPACK® packages, depending on their level of environmental compliance. ECOPACK® specifications, grade definitions and product status are available at: [www.st.com](http://www.st.com). ECOPACK® is an ST trademark.



### 4.1 DPAK (TO-252) type A package information

Figure 17. DPAK (TO-252) type A package outline

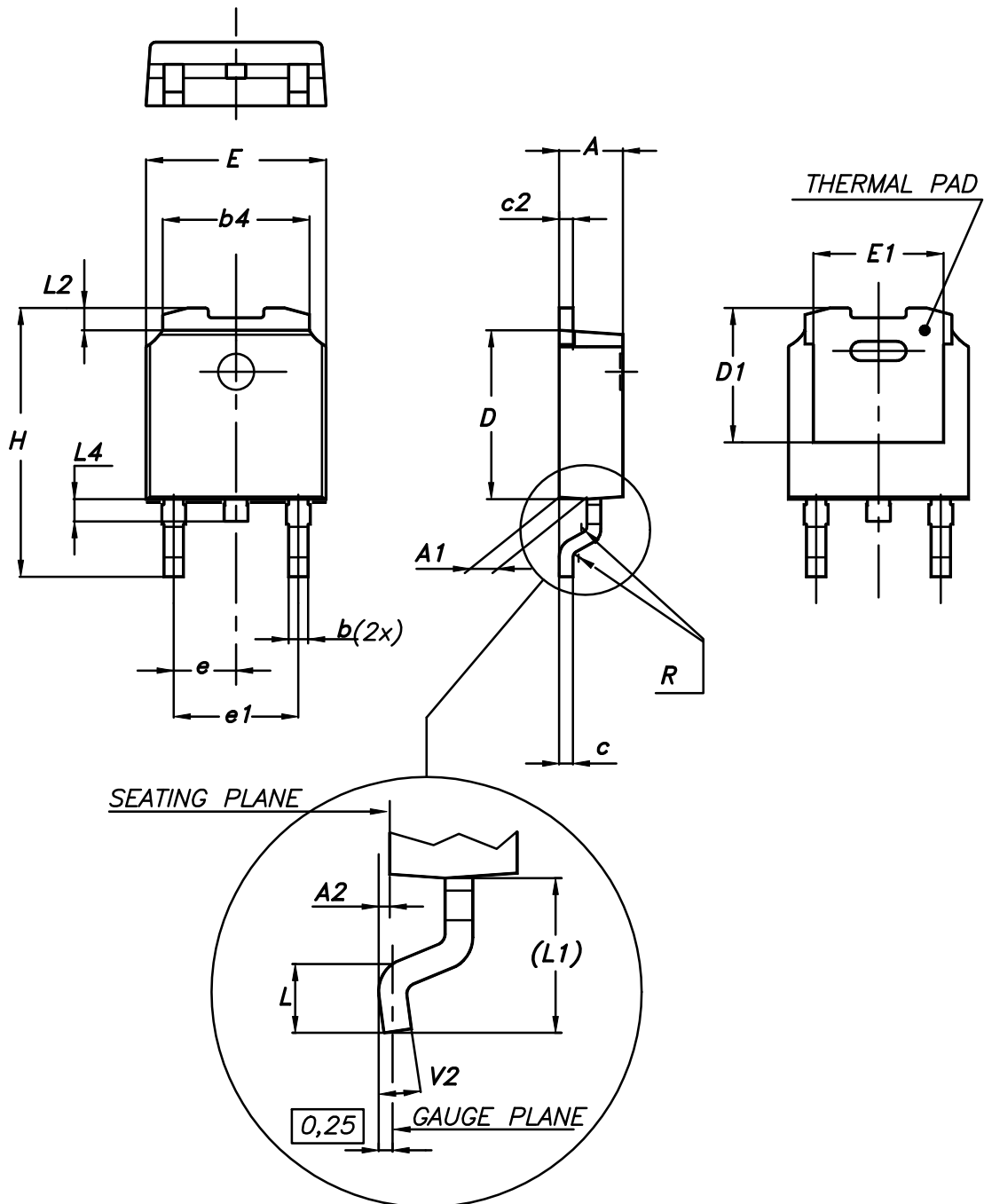

0068772\_A\_25

**Table 7. DPAK (TO-252) type A mechanical data**

Dim.	mm		
	Min.	Typ.	Max.
A	2.20		2.40
A1	0.90		1.10
A2	0.03		0.23
b	0.64		0.90
b4	5.20		5.40
c	0.45		0.60
c2	0.48		0.60
D	6.00		6.20
D1	4.95	5.10	5.25
E	6.40		6.60
E1	4.60	4.70	4.80
e	2.159	2.286	2.413
e1	4.445	4.572	4.699
H	9.35		10.10
L	1.00		1.50
(L1)	2.60	2.80	3.00
L2	0.65	0.80	0.95
L4	0.60		1.00
R		0.20	
V2	0°		8°

## 4.2 DPAK (TO-252) type C2 package information

Figure 18. DPAK (TO-252) type C2 package outline

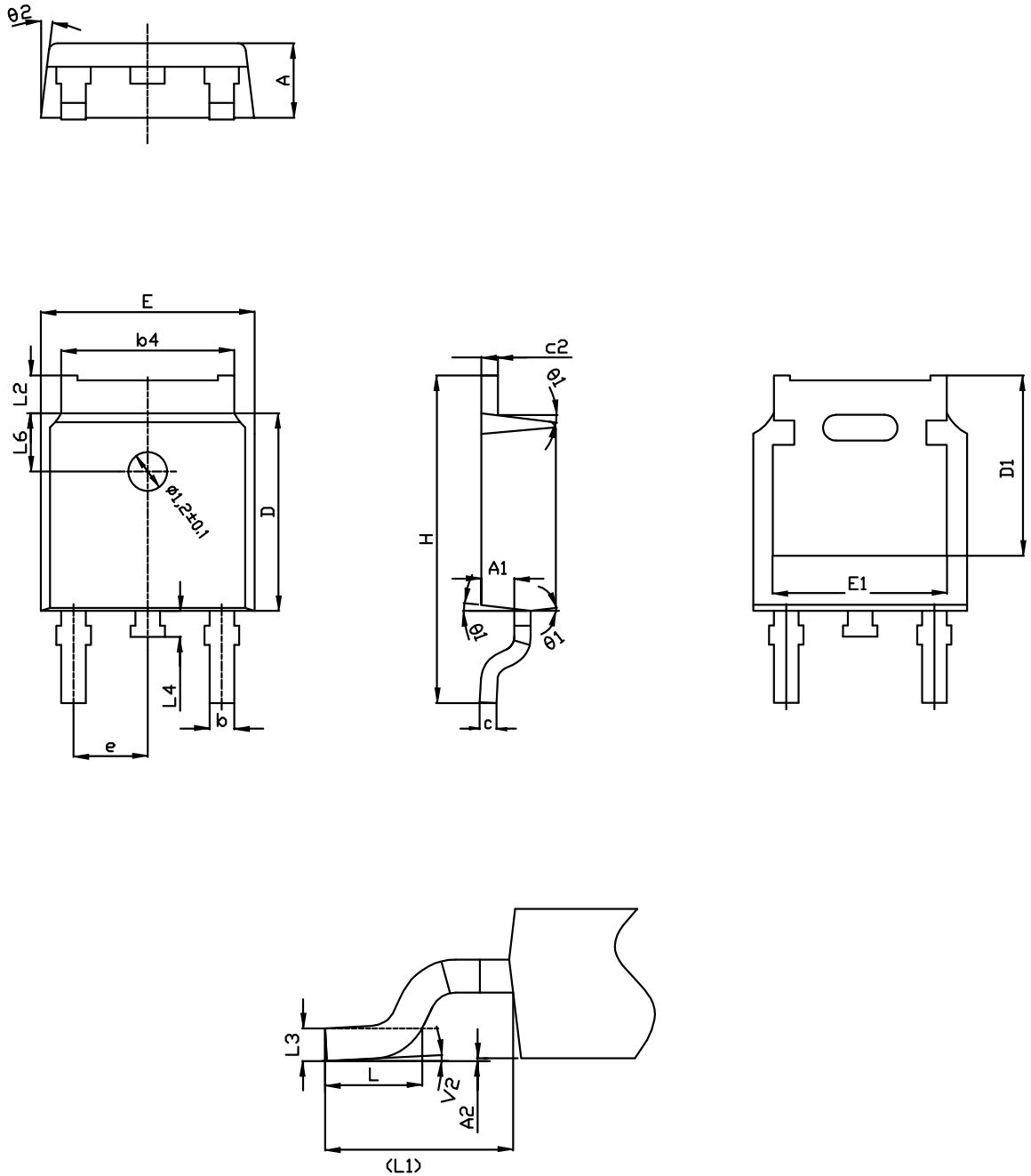

0068772\_C2\_25

**Table 8. DPAK (TO-252) type C2 mechanical data**

Dim.	mm		
	Min.	Typ.	Max.
A	2.20	2.30	2.38
A1	0.90	1.01	1.10
A2	0.00		0.10
b	0.72		0.85
b4	5.13	5.33	5.46
c	0.47		0.60
c2	0.47		0.60
D	6.00	6.10	6.20
D1	5.10		5.60
E	6.50	6.60	6.70
E1	5.20		5.50
e	2.186	2.286	2.386
H	9.80	10.10	10.40
L	1.40	1.50	1.70
L1	2.90 REF		
L2	0.90		1.25
L3	0.51 BSC		
L4	0.60	0.80	1.00
L6	1.80 BSC		
θ1	5°	7°	9°
θ2	5°	7°	9°
V2	0°		8°

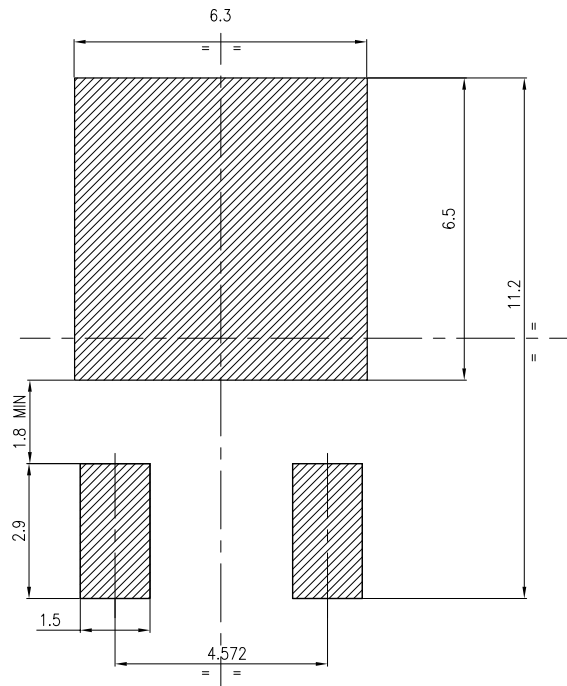
**Figure 19. DPAK (TO-252) recommended footprint (dimensions are in mm)**

FP\_0068772\_25

### 4.3 DPAK (TO-252) packing information

Figure 20. DPAK (TO-252) tape outline

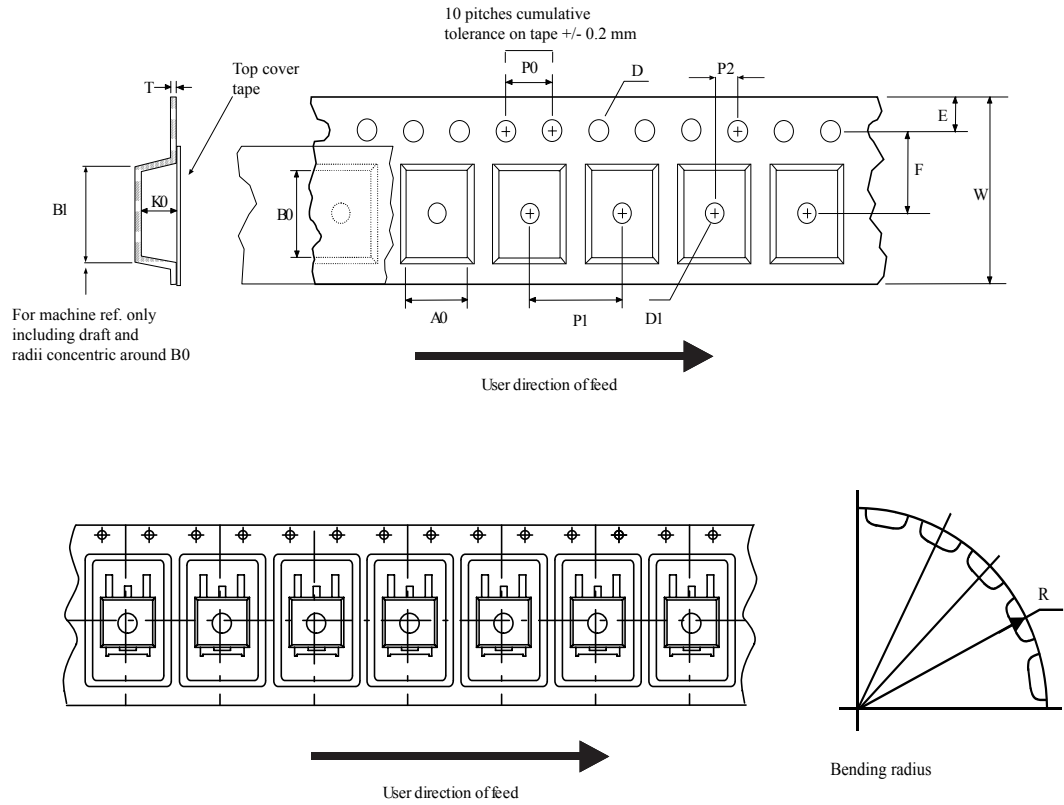

AM08852v1

**Figure 21. DPAK (TO-252) reel outline**

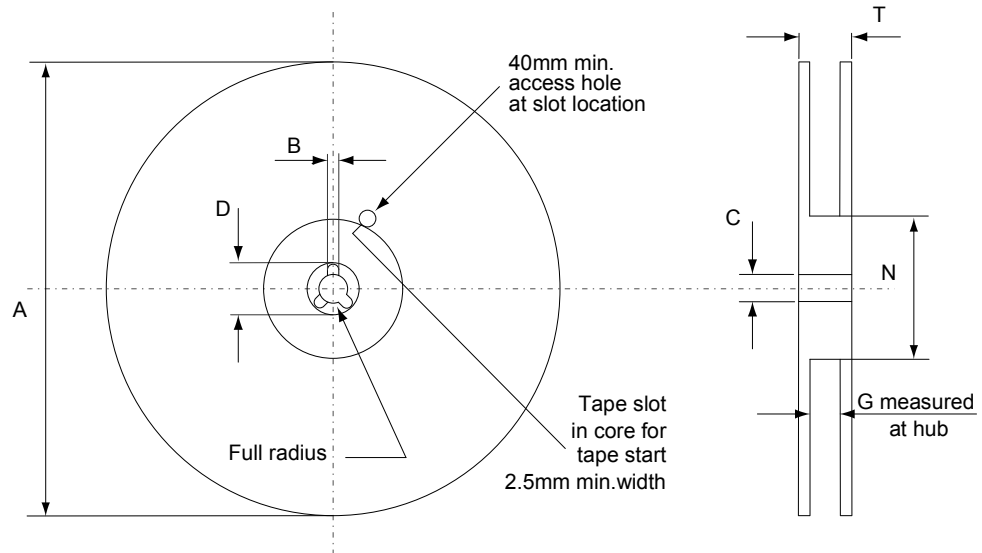

AM06038v1

**Table 9. DPAK (TO-252) tape and reel mechanical data**

Tape			Reel		
Dim.	mm		Dim.	mm	
	Min.	Max.		Min.	Max.
A0	6.8	7	A		330
B0	10.4	10.6	B	1.5	
B1		12.1	C	12.8	13.2
D	1.5	1.6	D	20.2	
D1	1.5		G	16.4	18.4
E	1.65	1.85	N	50	
F	7.4	7.6	T		22.4
K0	2.55	2.75			
P0	3.9	4.1	Base qty.		2500
P1	7.9	8.1	Bulk qty.		2500
P2	1.9	2.1			
R	40				
T	0.25	0.35			
W	15.7	16.3			

## Revision history

**Table 10. Document revision history**

Date	Version	Changes
21-Jun-2004	3	Preliminary version
03-Jul-2006	4	New template, no content change
09-Aug-2018	5	Updated information on cover page. Updated <a href="#">Section 4 Package information</a> . Minor text changes



## Contents

<b>1</b>	<b>Electrical ratings</b> .....	<b>2</b>
<b>2</b>	<b>Electrical characteristics</b> .....	<b>3</b>
<b>2.1</b>	Electrical characteristics (curves) .....	5
<b>3</b>	<b>Test circuits</b> .....	<b>7</b>
<b>4</b>	<b>Package information</b> .....	<b>8</b>
<b>4.1</b>	DPAK (TO-252) type A package information .....	8
<b>4.2</b>	DPAK (TO-252) type C2 package information .....	10
<b>4.3</b>	DPAK (TO-252) packing information .....	13
	<b>Revision history</b> .....	<b>16</b>

**IMPORTANT NOTICE – PLEASE READ CAREFULLY**

STMicroelectronics NV and its subsidiaries (“ST”) reserve the right to make changes, corrections, enhancements, modifications, and improvements to ST products and/or to this document at any time without notice. Purchasers should obtain the latest relevant information on ST products before placing orders. ST products are sold pursuant to ST’s terms and conditions of sale in place at the time of order acknowledgement.

Purchasers are solely responsible for the choice, selection, and use of ST products and ST assumes no liability for application assistance or the design of Purchasers’ products.

No license, express or implied, to any intellectual property right is granted by ST herein.

Resale of ST products with provisions different from the information set forth herein shall void any warranty granted by ST for such product.

ST and the ST logo are trademarks of ST. All other product or service names are the property of their respective owners.

Information in this document supersedes and replaces information previously supplied in any prior versions of this document.

© 2018 STMicroelectronics – All rights reserved

## X-ON Electronics

Largest Supplier of Electrical and Electronic Components

*Click to view similar products for [MOSFET](#) category:*

*Click to view products by [STMicroelectronics](#) manufacturer:*

Other Similar products are found below :

[614233C](#) [648584F](#) [IRFD120](#) [JANTX2N5237](#) [FCA20N60\\_F109](#) [FDZ595PZ](#) [2SK2545\(Q,T\)](#) [405094E](#) [423220D](#) [TPCC8103,L1Q\(CM](#)  
[MIC4420CM-TR](#) [VN1206L](#) [SBVS138LT1G](#) [614234A](#) [715780A](#) [NTNS3166NZT5G](#) [SSM6J414TU,LF\(T](#) [751625C](#) [BUK954R8-60E](#)  
[NTE6400](#) [SQJ402EP-T1-GE3](#) [2SK2614\(TE16L1,Q\)](#) [2N7002KW-FAI](#) [DMN1017UCP3-7](#) [EFC2J004NUZTDG](#) [ECH8691-TL-W](#)  
[FCAB21350L1](#) [P85W28HP2F-7071](#) [DMN1053UCP4-7](#) [NTE221](#) [NTE2384](#) [NTE2903](#) [NTE2941](#) [NTE2945](#) [NTE2946](#) [NTE2960](#) [NTE2967](#)  
[NTE2969](#) [NTE2976](#) [NTE455](#) [NTE6400A](#) [NTE2910](#) [NTE2916](#) [NTE2956](#) [NTE2911](#) [DMN2080UCB4-7](#) [TK10A80W,S4X\(S](#)  
[SSM6P69NU,LF](#) [DMP22D4UFO-7B](#) [DMN1006UCA6-7](#)