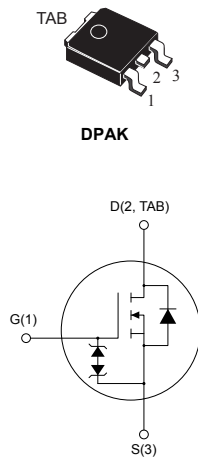


## N-channel 525 V, 1 $\Omega$ typ., 6.5 A MDmesh™ K3 Power MOSFET in DPAK package



### Features

| Order codes | $V_{DS}$ | $R_{DS(on)}$ max. | $I_D$ | $P_{TOT}$ |
|-------------|----------|-------------------|-------|-----------|
| STD6N52K3   | 525 V    | 1.2 $\Omega$      | 5 A   | 70 W      |

- 100% avalanche tested
- Extremely high dv/dt capability
- Very low intrinsic capacitance
- Improved diode reverse recovery characteristics
- Zener-protected

### Applications

- Switching applications

### Description

This MDmesh™ K3 Power MOSFET is the result of improvements applied to STMicroelectronics' MDmesh™ technology, combined with a new optimized vertical structure. This device boasts an extremely low on-resistance, superior dynamic performance and high avalanche capability, rendering it suitable for the most demanding applications.

#### Product status link

[STD6N52K3](#)

#### Product summary

|                   |               |
|-------------------|---------------|
| <b>Order code</b> | STD6N52K3     |
| <b>Marking</b>    | 6N52K3        |
| <b>Package</b>    | DPAK          |
| <b>Packing</b>    | Tape and reel |

# 1 Electrical ratings

**Table 1. Absolute maximum ratings**

| Symbol         | Parameter                                                       | Value      | Unit             |
|----------------|-----------------------------------------------------------------|------------|------------------|
| $V_{GS}$       | Gate- source voltage                                            | $\pm 30$   | V                |
| $I_D$          | Drain current (continuous) at $T_C = 25\text{ }^\circ\text{C}$  | 5          | A                |
| $I_D$          | Drain current (continuous) at $T_C = 100\text{ }^\circ\text{C}$ | 3          | A                |
| $I_{DM}^{(1)}$ | Drain current (pulsed)                                          | 20         | A                |
| $P_{TOT}$      | Total dissipation at $T_C = 25\text{ }^\circ\text{C}$           | 70         | W                |
| $I_{AR}$       | Avalanche current, repetitive or not-repetitive                 | 2.5        | A                |
| $E_{AS}^{(2)}$ | Single pulse avalanche energy                                   | 110        | mJ               |
| $dv/dt^{(3)}$  | Peak diode recovery voltage slope                               | 12         | V/ns             |
| $T_{stg}$      | Storage temperature range                                       | -55 to 150 | $^\circ\text{C}$ |
| $T_j$          | Operating junction temperature range                            |            |                  |

1. Pulse width limited by safe operating area.
2. Starting  $T_j = 25\text{ }^\circ\text{C}$ ,  $I_D = I_{AR}$ ,  $V_{DD} = 50\text{ V}$ .
3.  $I_{SD} \leq 5\text{ A}$ ,  $di/dt \leq 400\text{ A}/\mu\text{s}$ ,  $V_{DD} = 80\% V_{(BR)DSS}$ ,  $V_{DS\ peak} \leq V_{(BR)DSS}$ .

**Table 2. Thermal data**

| Symbol              | Parameter                        | Value | Unit                      |
|---------------------|----------------------------------|-------|---------------------------|
| $R_{thj-case}$      | Thermal resistance junction-case | 1.79  | $^\circ\text{C}/\text{W}$ |
| $R_{thj-pcb}^{(1)}$ | Thermal resistance junction-pcb  | 50    | $^\circ\text{C}/\text{W}$ |

1. When mounted on 1inch<sup>2</sup> FR-4 board, 2 oz Cu.

## 2 Electrical characteristics

( $T_C = 25\text{ °C}$  unless otherwise specified)

**Table 3. On /off states**

| Symbol        | Parameter                         | Test conditions                                                                         | Min. | Typ. | Max.     | Unit          |
|---------------|-----------------------------------|-----------------------------------------------------------------------------------------|------|------|----------|---------------|
| $V_{(BR)DSS}$ | Drain-source breakdown voltage    | $I_D = 1\text{ mA}$ , $V_{GS} = 0\text{ V}$                                             | 525  |      |          | V             |
| $I_{DSS}$     | Zero gate voltage drain current   | $V_{GS} = 0\text{ V}$ , $V_{DS} = 525\text{ V}$                                         |      |      | 1        | $\mu\text{A}$ |
|               |                                   | $V_{GS} = 0\text{ V}$ , $V_{DS} = 525\text{ V}$<br>$T_C = 125\text{ °C}$ <sup>(1)</sup> |      |      | 50       | $\mu\text{A}$ |
| $I_{GSS}$     | Gate body leakage current         | $V_{GS} = \pm 20\text{ V}$ , $V_{DS} = 0\text{ V}$                                      |      |      | $\pm 10$ | $\mu\text{A}$ |
| $V_{GS(th)}$  | Gate threshold voltage            | $V_{DS} = V_{GS}$ , $I_D = 50\text{ }\mu\text{A}$                                       | 3    | 3.75 | 4.5      | V             |
| $R_{DS(on)}$  | Static drain-source on resistance | $V_{GS} = 10\text{ V}$ , $I_D = 2.5\text{ A}$                                           |      | 1    | 1.2      | $\Omega$      |

1. Defined by design, not subject to production test.

**Table 4. Dynamic**

| Symbol                     | Parameter                     | Test conditions                                                                                                                                | Min. | Typ. | Max. | Unit          |
|----------------------------|-------------------------------|------------------------------------------------------------------------------------------------------------------------------------------------|------|------|------|---------------|
| $C_{iss}$                  | Input capacitance             | $V_{DS} = 50\text{ V}$ , $f = 1\text{ MHz}$ ,<br>$V_{GS} = 0\text{ V}$                                                                         | -    | 670  | -    | $\mu\text{F}$ |
| $C_{oss}$                  | Output capacitance            |                                                                                                                                                |      | 54   |      |               |
| $C_{rss}$                  | Reverse transfer capacitance  |                                                                                                                                                |      | 10   |      |               |
| $C_{oss\text{ eq.}}^{(1)}$ | Equivalent output capacitance | $V_{GS} = 0\text{ V}$ ,<br>$V_{DS} = 0\text{ to }420\text{ V}$                                                                                 |      | 40   |      | $\mu\text{F}$ |
| $R_G$                      | Intrinsic gate resistance     | $f = 1\text{ MHz}$ open drain                                                                                                                  | -    | 4    | -    | $\Omega$      |
| $Q_g$                      | Total gate charge             | $V_{DD} = 420\text{ V}$ , $I_D = 5\text{ A}$ ,<br>$V_{GS} = 0\text{ to }10\text{ V}$<br>(see Figure 15. Test circuit for gate charge behavior) | -    | 26   | -    | nC            |
| $Q_{gs}$                   | Gate-source charge            |                                                                                                                                                |      | 4    |      |               |
| $Q_{gd}$                   | Gate-drain charge             |                                                                                                                                                |      | 15   |      |               |

1.  $C_{oss\text{ eq.}}$  is defined as a constant equivalent capacitance giving the same charging time as  $C_{oss}$  when  $V_{DS}$  increases from 0 to 80%  $V_{DSS}$ .

**Table 5. Switching times**

| Symbol       | Parameter           | Test conditions                                                                                                                                                                                                   | Min. | Typ. | Max. | Unit |
|--------------|---------------------|-------------------------------------------------------------------------------------------------------------------------------------------------------------------------------------------------------------------|------|------|------|------|
| $t_{d(on)}$  | Turn-on delay time  | $V_{DD} = 260\text{ V}$ , $I_D = 2.5\text{ A}$ ,<br>$R_G = 4.7\text{ }\Omega$ , $V_{GS} = 10\text{ V}$<br>(see Figure 14. Test circuit for resistive load switching times and Figure 19. Switching time waveform) | -    | 10   | -    | ns   |
| $t_r$        | Rise time           |                                                                                                                                                                                                                   |      | 11   |      |      |
| $t_{d(off)}$ | Turn-off delay time |                                                                                                                                                                                                                   |      | 31   |      |      |
| $t_f$        | Fall time           |                                                                                                                                                                                                                   |      | 18   |      |      |

**Table 6. Source drain diode**

| Symbol          | Parameter                     | Test conditions                                                                                                                                                                                     | Min. | Typ. | Max. | Unit |    |
|-----------------|-------------------------------|-----------------------------------------------------------------------------------------------------------------------------------------------------------------------------------------------------|------|------|------|------|----|
| $I_{SD}$        | Source-drain current          |                                                                                                                                                                                                     | -    |      | 5    | A    |    |
| $I_{SDM}^{(1)}$ | Source-drain current (pulsed) |                                                                                                                                                                                                     |      |      | 20   |      |    |
| $V_{SD}^{(2)}$  | Forward on voltage            | $I_{SD} = 5\text{ A}$ , $V_{GS} = 0\text{ V}$                                                                                                                                                       | -    |      | 1.5  | V    |    |
| $t_{rr}$        | Reverse recovery time         | $I_{SD} = 5\text{ A}$ , $di/dt = 100\text{ A}/\mu\text{s}$<br>$V_{DD} = 60\text{ V}$ (see Figure 16. Test circuit for inductive load switching and diode recovery times)                            | -    | 206  |      | ns   |    |
| $Q_{rr}$        | Reverse recovery charge       |                                                                                                                                                                                                     |      | 1.4  |      |      | μC |
| $I_{RRM}$       | Reverse recovery current      |                                                                                                                                                                                                     |      | 14   |      |      |    |
| $t_{rr}$        | Reverse recovery time         | $I_{SD} = 5\text{ A}$ , $di/dt = 100\text{ A}/\mu\text{s}$<br>$V_{DD} = 60\text{ V}$ , $T_j = 150\text{ °C}$<br>(see Figure 16. Test circuit for inductive load switching and diode recovery times) | -    | 233  |      | ns   |    |
| $Q_{rr}$        | Reverse recovery charge       |                                                                                                                                                                                                     |      | 1.7  |      |      | μC |
| $I_{RRM}$       | Reverse recovery current      |                                                                                                                                                                                                     |      | 15   |      |      |    |

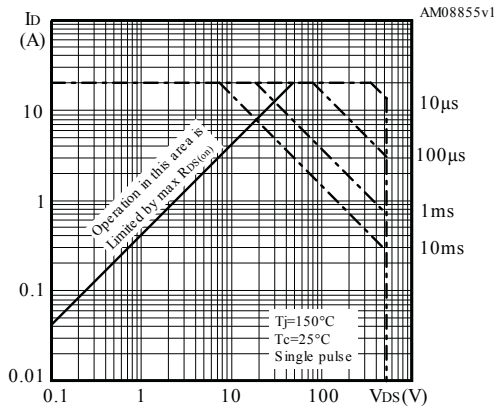
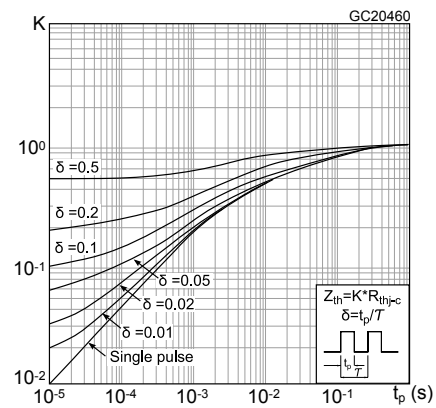
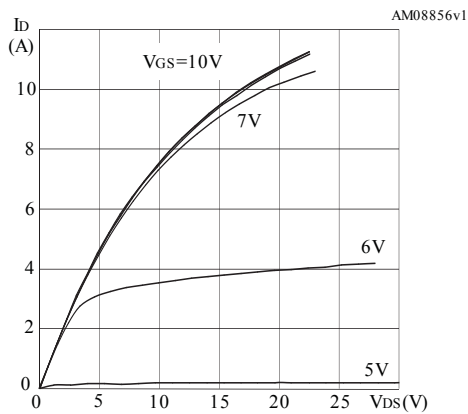
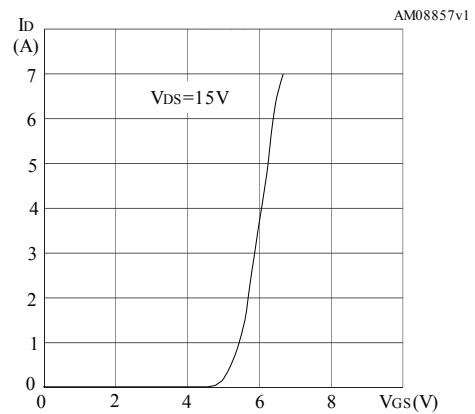
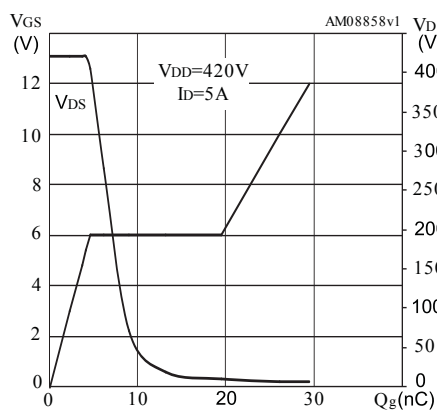
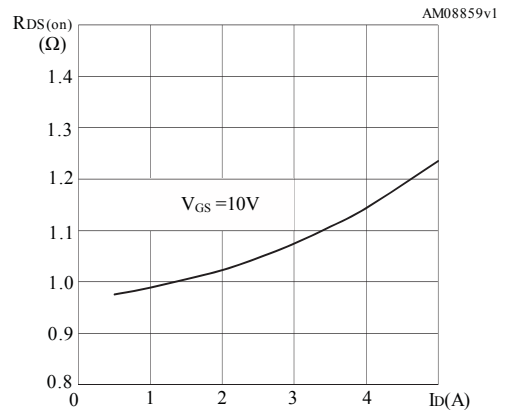
1. Pulse width limited by safe operating area.
2. Pulsed: pulse duration = 300 μs, duty cycle 1.5%.

**Table 7. Gate-source Zener diode**

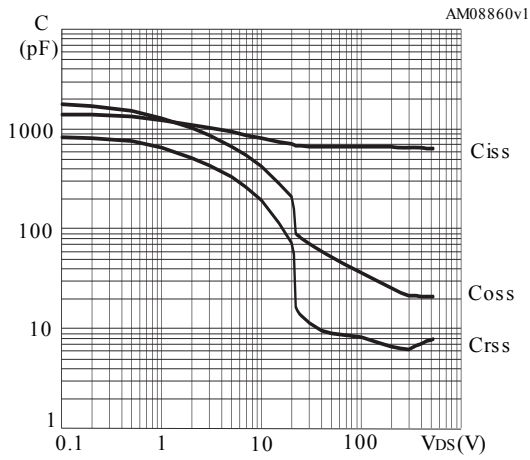
| Symbol        | Parameter                     | Test conditions                                 | Min. | Typ. | Max. | Unit |
|---------------|-------------------------------|-------------------------------------------------|------|------|------|------|
| $V_{(BR)GSO}$ | Gate-source breakdown voltage | $I_D = 0\text{ A}$ , $I_{GS} = \pm 1\text{ mA}$ | ±30  | -    |      | V    |

The built-in back-to-back Zener diodes are specifically designed to enhance the ESD performance of the device. The Zener voltage facilitates efficient and cost-effective device integrity protection, thus eliminating the need for additional external componentry.

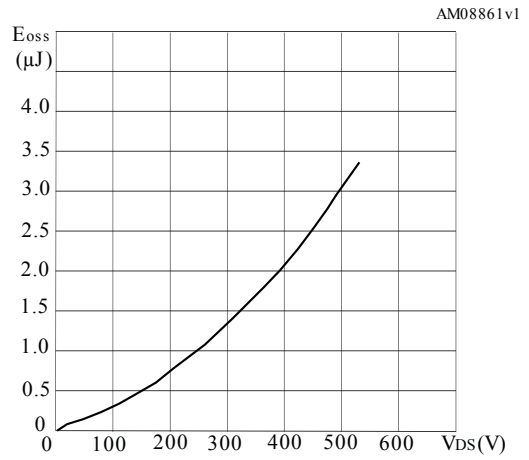
## 2.1 Electrical characteristics curves

**Figure 1. Safe operating area**

**Figure 2. Thermal impedance**

**Figure 3. Output characteristics**

**Figure 4. Transfer characteristics**

**Figure 5. Gate charge vs gate-source voltage**

**Figure 6. Static drain-source on resistance**


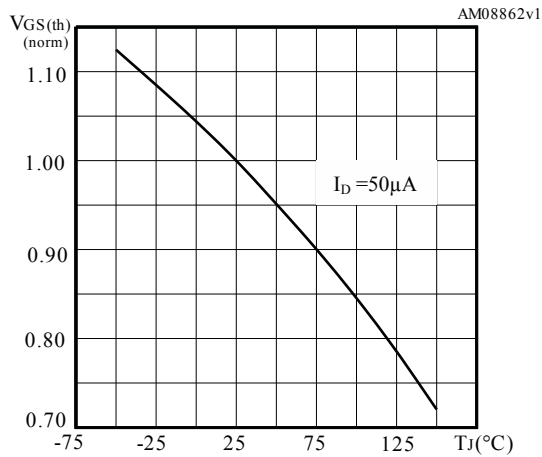
**Figure 7. Capacitance variations**



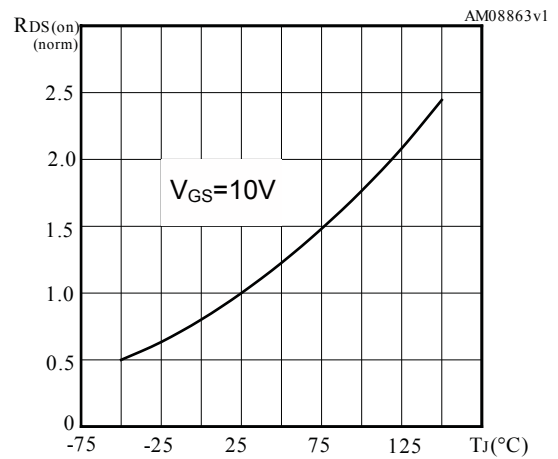
**Figure 8. Output capacitance stored energy**



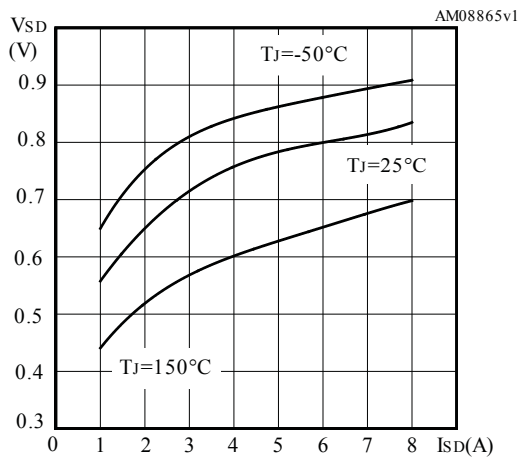
**Figure 9. Normalized gate threshold voltage vs temperature**



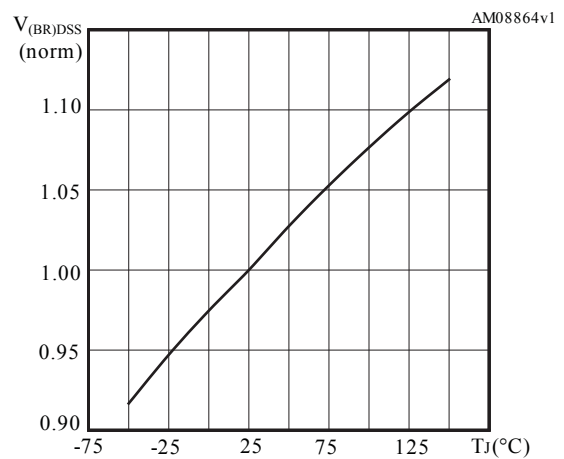
**Figure 10. Normalized on resistance vs temperature**

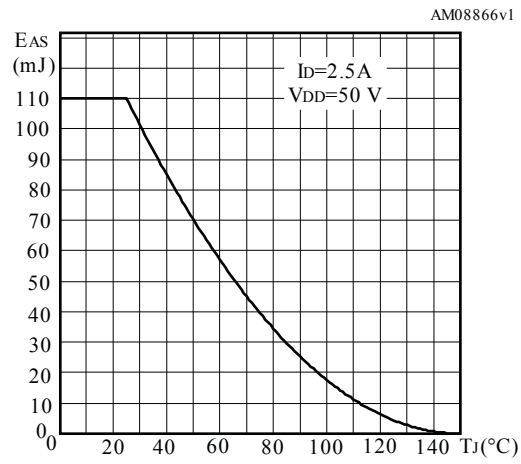


**Figure 11. Source-drain diode forward characteristics**

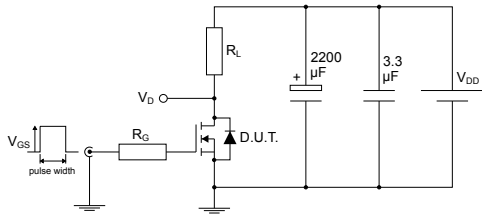


**Figure 12. Normalized V(BR)DSS vs temperature**

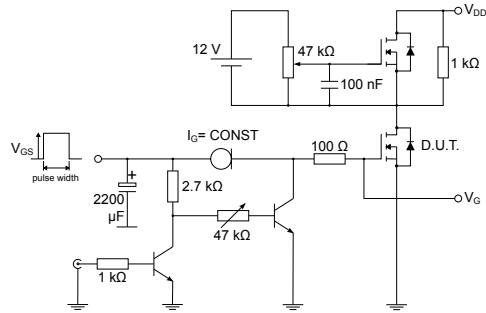


**Figure 13. Maximum avalanche energy vs temperature**


### 3 Test circuits

**Figure 14. Test circuit for resistive load switching times**


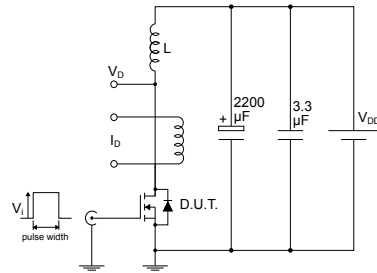
AM01468v1

**Figure 15. Test circuit for gate charge behavior**


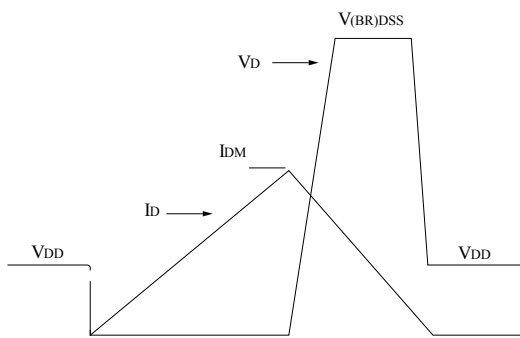
AM01469v1

**Figure 16. Test circuit for inductive load switching and diode recovery times**

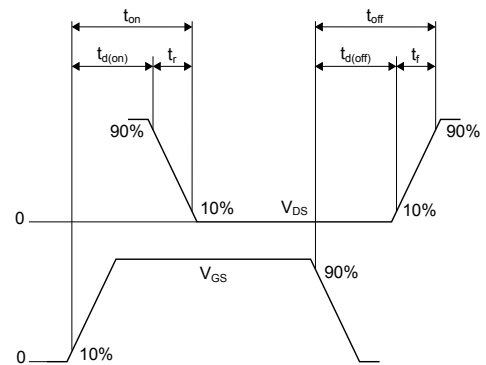

AM01470v1

**Figure 17. Unclamped inductive load test circuit**


AM01471v1

**Figure 18. Unclamped inductive waveform**


AM01472v1

**Figure 19. Switching time waveform**


AM01473v1



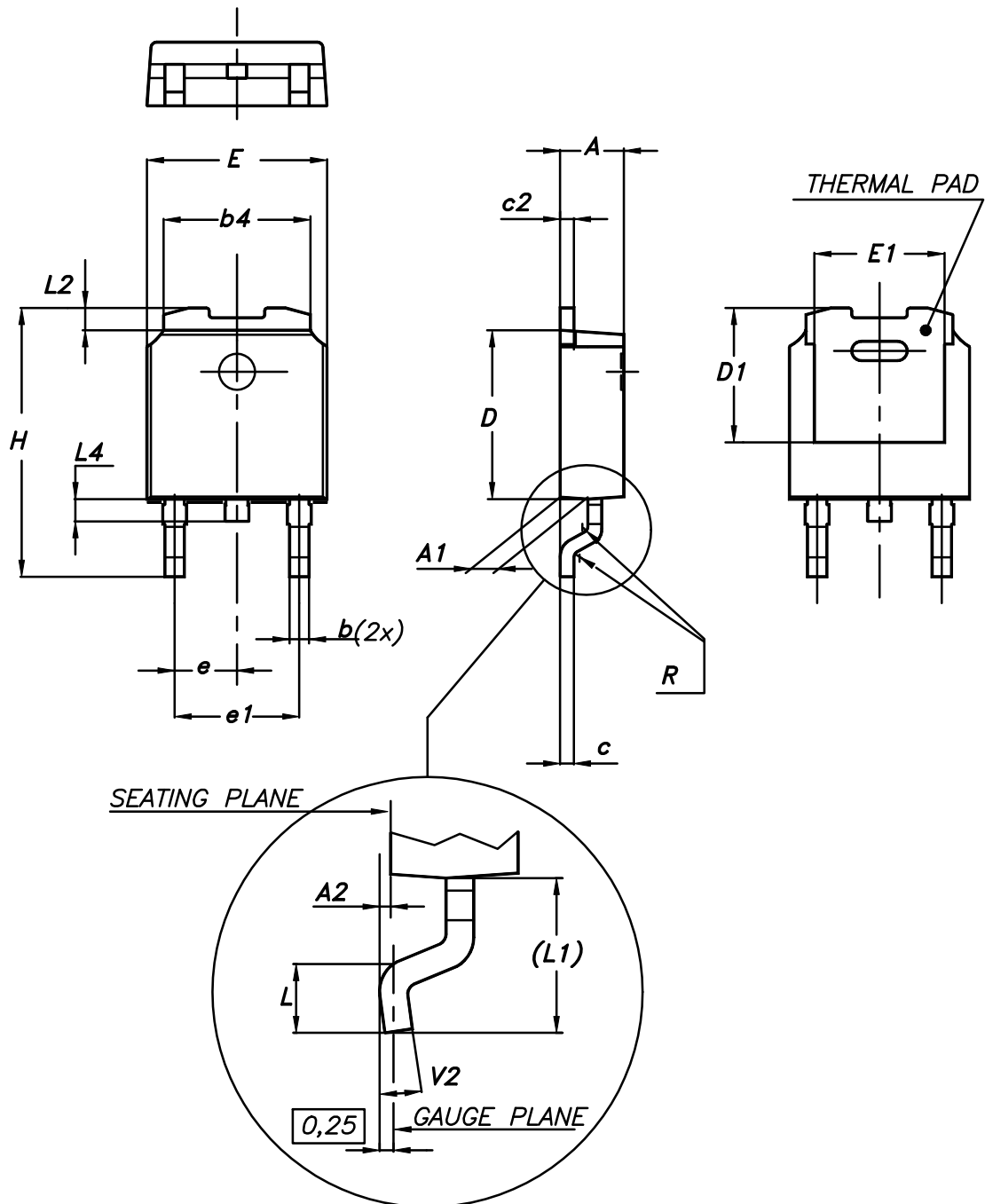
## 4 Package information

---

In order to meet environmental requirements, ST offers these devices in different grades of ECOPACK® packages, depending on their level of environmental compliance. ECOPACK® specifications, grade definitions and product status are available at: [www.st.com](http://www.st.com). ECOPACK® is an ST trademark.

### 4.1 DPAK (TO-252) type A package information

Figure 20. DPAK (TO-252) type A package outline



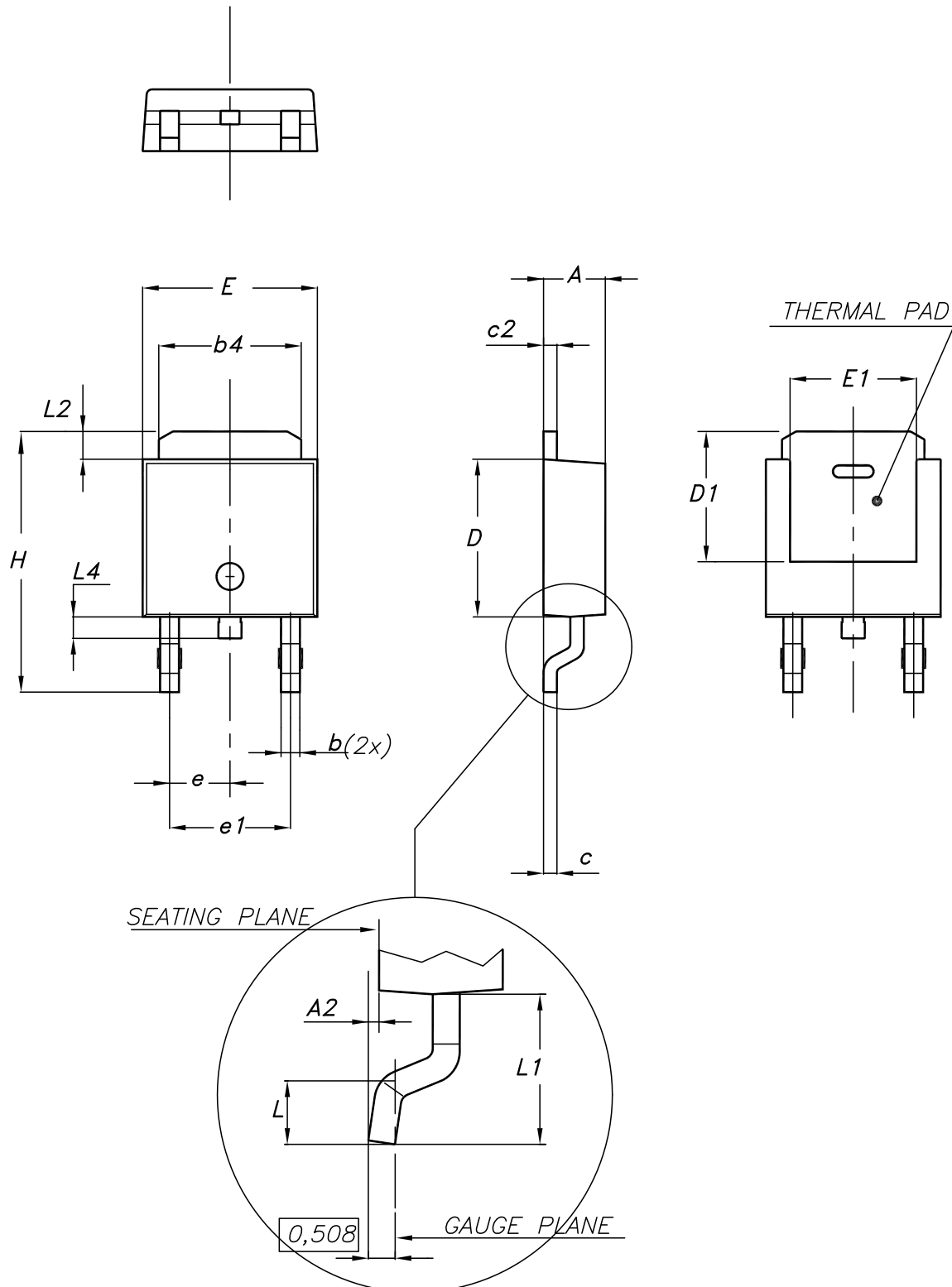
0068772\_A\_25

**Table 8. DPAK (TO-252) type A mechanical data**

| Dim. | mm    |       |       |
|------|-------|-------|-------|
|      | Min.  | Typ.  | Max.  |
| A    | 2.20  |       | 2.40  |
| A1   | 0.90  |       | 1.10  |
| A2   | 0.03  |       | 0.23  |
| b    | 0.64  |       | 0.90  |
| b4   | 5.20  |       | 5.40  |
| c    | 0.45  |       | 0.60  |
| c2   | 0.48  |       | 0.60  |
| D    | 6.00  |       | 6.20  |
| D1   | 4.95  | 5.10  | 5.25  |
| E    | 6.40  |       | 6.60  |
| E1   | 4.60  | 4.70  | 4.80  |
| e    | 2.159 | 2.286 | 2.413 |
| e1   | 4.445 | 4.572 | 4.699 |
| H    | 9.35  |       | 10.10 |
| L    | 1.00  |       | 1.50  |
| (L1) | 2.60  | 2.80  | 3.00  |
| L2   | 0.65  | 0.80  | 0.95  |
| L4   | 0.60  |       | 1.00  |
| R    |       | 0.20  |       |
| V2   | 0°    |       | 8°    |

## 4.2 DPAK (TO-252) type E package information

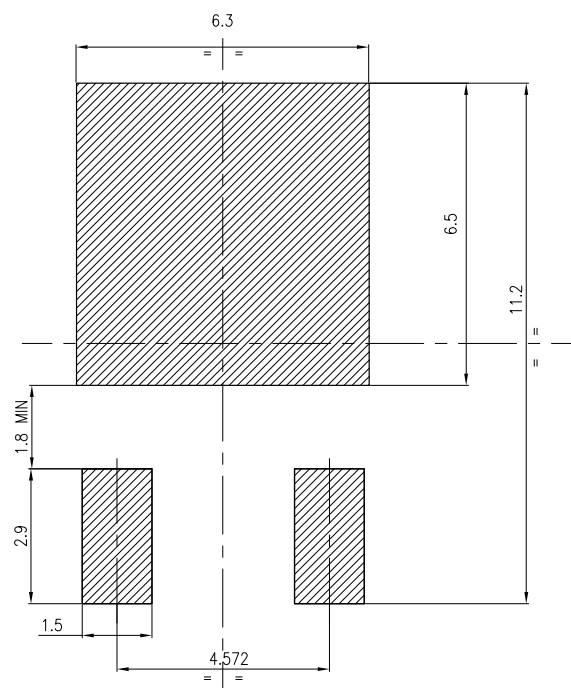
Figure 21. DPAK (TO-252) type E package outline



**Table 9. DPAK (TO-252) type E mechanical data**

| Dim. | mm   |       |       |
|------|------|-------|-------|
|      | Min. | Typ.  | Max.  |
| A    | 2.18 |       | 2.39  |
| A2   |      |       | 0.13  |
| b    | 0.65 |       | 0.884 |
| b4   | 4.95 |       | 5.46  |
| c    | 0.46 |       | 0.61  |
| c2   | 0.46 |       | 0.60  |
| D    | 5.97 |       | 6.22  |
| D1   | 5.21 |       |       |
| E    | 6.35 |       | 6.73  |
| E1   | 4.32 |       |       |
| e    |      | 2.286 |       |
| e1   |      | 4.572 |       |
| H    | 9.94 |       | 10.34 |
| L    | 1.50 |       | 1.78  |
| L1   |      | 2.74  |       |
| L2   | 0.89 |       | 1.27  |
| L4   |      |       | 1.02  |

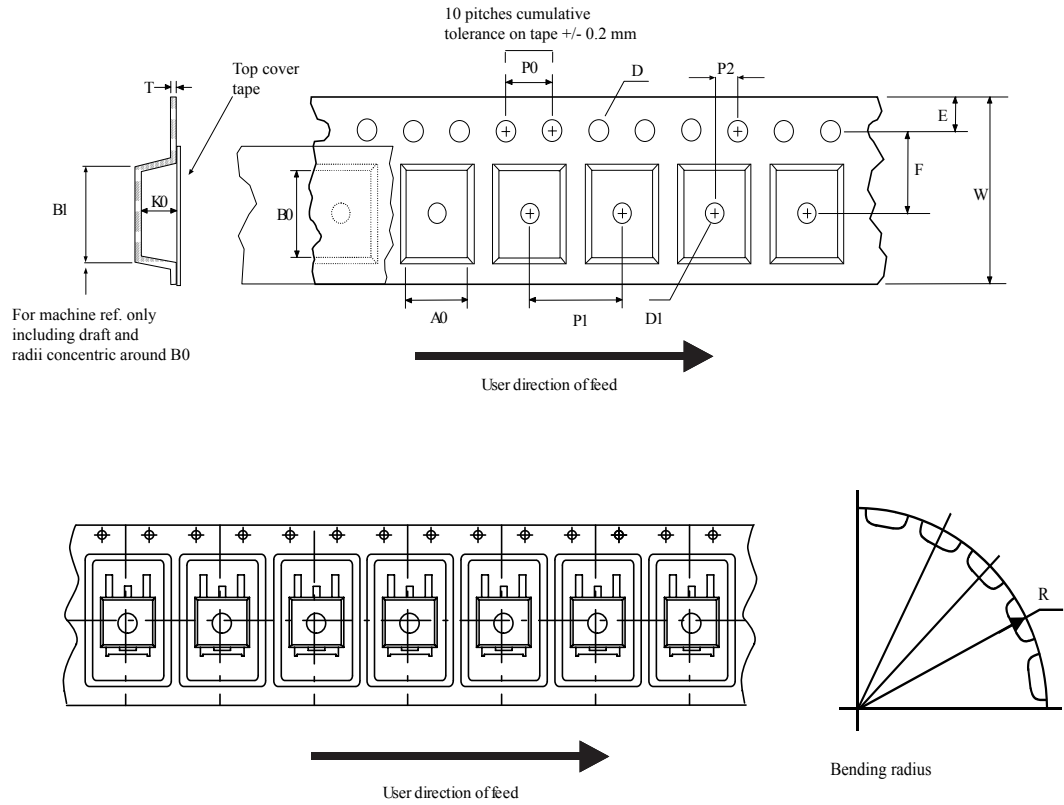
**Figure 22. DPAK (TO-252) recommended footprint (dimensions are in mm)**



FP\_0068772\_25

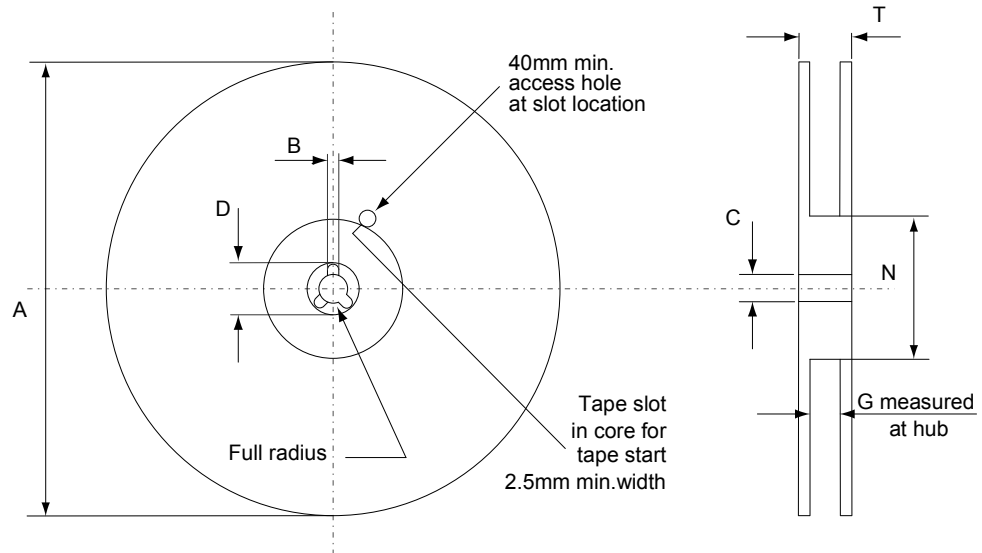
### 4.3 DPAK (TO-252) packing information

Figure 23. DPAK (TO-252) tape outline



AM08852v1

**Figure 24. DPAK (TO-252) reel outline**



AM06038v1

**Table 10. DPAK (TO-252) tape and reel mechanical data**

| Tape |      |      | Reel      |      |      |
|------|------|------|-----------|------|------|
| Dim. | mm   |      | Dim.      | mm   |      |
|      | Min. | Max. |           | Min. | Max. |
| A0   | 6.8  | 7    | A         |      | 330  |
| B0   | 10.4 | 10.6 | B         | 1.5  |      |
| B1   |      | 12.1 | C         | 12.8 | 13.2 |
| D    | 1.5  | 1.6  | D         | 20.2 |      |
| D1   | 1.5  |      | G         | 16.4 | 18.4 |
| E    | 1.65 | 1.85 | N         | 50   |      |
| F    | 7.4  | 7.6  | T         |      | 22.4 |
| K0   | 2.55 | 2.75 |           |      |      |
| P0   | 3.9  | 4.1  | Base qty. |      | 2500 |
| P1   | 7.9  | 8.1  | Bulk qty. |      | 2500 |
| P2   | 1.9  | 2.1  |           |      |      |
| R    | 40   |      |           |      |      |
| T    | 0.25 | 0.35 |           |      |      |
| W    | 15.7 | 16.3 |           |      |      |

## Revision history

**Table 11. Document revision history**

| Date        | Revision | Changes                                                                                                                                                                                                                                                                                                                                                                                                                                                 |
|-------------|----------|---------------------------------------------------------------------------------------------------------------------------------------------------------------------------------------------------------------------------------------------------------------------------------------------------------------------------------------------------------------------------------------------------------------------------------------------------------|
| 03-Sep-2008 | 1        | Initial release.                                                                                                                                                                                                                                                                                                                                                                                                                                        |
| 21-Feb-2011 | 2        | <ul style="list-style-type: none"> <li>– Added new package, mechanical data: D<sup>2</sup>PAK;</li> <li>– Added new package, mechanical data: TO-220;</li> <li>– Document status promoted from preliminary data to datasheet.</li> </ul>                                                                                                                                                                                                                |
| 05-Sep-2018 | 3        | <p>The part numbers STB6N52K3, STF6N52K3 and STP6N52K3 have been moved to a separate datasheet.</p> <p>Removed maturity status indication from cover page. The document status is production data.</p> <p>Updated title and features in cover page.</p> <p>Updated <a href="#">Section 1 Electrical ratings</a>, <a href="#">Section 2 Electrical characteristics</a> and <a href="#">Section 4 Package information</a>.</p> <p>Minor text changes.</p> |



## Contents

|            |                                                |           |
|------------|------------------------------------------------|-----------|
| <b>1</b>   | <b>Electrical ratings</b> .....                | <b>2</b>  |
| <b>2</b>   | <b>Electrical characteristics</b> .....        | <b>3</b>  |
| <b>2.1</b> | Electrical characteristics curves .....        | 5         |
| <b>3</b>   | <b>Test circuits</b> .....                     | <b>8</b>  |
| <b>4</b>   | <b>Package information</b> .....               | <b>9</b>  |
| <b>4.1</b> | DPAK (TO-252) type A package information ..... | 9         |
| <b>4.2</b> | DPAK (TO-252) type E package information ..... | 11        |
| <b>4.3</b> | DPAK (TO-252) packing information .....        | 13        |
|            | <b>Revision history</b> .....                  | <b>16</b> |

**IMPORTANT NOTICE – PLEASE READ CAREFULLY**

STMicroelectronics NV and its subsidiaries (“ST”) reserve the right to make changes, corrections, enhancements, modifications, and improvements to ST products and/or to this document at any time without notice. Purchasers should obtain the latest relevant information on ST products before placing orders. ST products are sold pursuant to ST’s terms and conditions of sale in place at the time of order acknowledgement.

Purchasers are solely responsible for the choice, selection, and use of ST products and ST assumes no liability for application assistance or the design of Purchasers’ products.

No license, express or implied, to any intellectual property right is granted by ST herein.

Resale of ST products with provisions different from the information set forth herein shall void any warranty granted by ST for such product.

ST and the ST logo are trademarks of ST. All other product or service names are the property of their respective owners.

Information in this document supersedes and replaces information previously supplied in any prior versions of this document.

© 2018 STMicroelectronics – All rights reserved

## X-ON Electronics

Largest Supplier of Electrical and Electronic Components

*Click to view similar products for [MOSFET](#) category:*

*Click to view products by [STMicroelectronics](#) manufacturer:*

Other Similar products are found below :

[614233C](#) [648584F](#) [IRFD120](#) [JANTX2N5237](#) [FCA20N60\\_F109](#) [FDZ595PZ](#) [2SK2545\(Q,T\)](#) [405094E](#) [423220D](#) [TPCC8103,L1Q\(CM](#)  
[MIC4420CM-TR](#) [VN1206L](#) [SBVS138LT1G](#) [614234A](#) [715780A](#) [NTNS3166NZT5G](#) [SSM6J414TU,LF\(T](#) [751625C](#) [BUK954R8-60E](#)  
[NTE6400](#) [SQJ402EP-T1-GE3](#) [2SK2614\(TE16L1,Q\)](#) [2N7002KW-FAI](#) [DMN1017UCP3-7](#) [EFC2J004NUZTDG](#) [ECH8691-TL-W](#)  
[FCAB21350L1](#) [P85W28HP2F-7071](#) [DMN1053UCP4-7](#) [NTE221](#) [NTE2384](#) [NTE2903](#) [NTE2941](#) [NTE2945](#) [NTE2946](#) [NTE2960](#) [NTE2967](#)  
[NTE2969](#) [NTE2976](#) [NTE455](#) [NTE6400A](#) [NTE2910](#) [NTE2916](#) [NTE2956](#) [NTE2911](#) [DMN2080UCB4-7](#) [TK10A80W,S4X\(S](#)  
[SSM6P69NU,LF](#) [DMP22D4UFO-7B](#) [DMN1006UCA6-7](#)