



STD70NS04ZL

N-channel clamped 9.5 mΩ, 70 A DPAK
fully protected SAFeFET™ Power MOSFET

Features

Type	V _{DSS}	R _{DS(on)} max	I _D
STD70NS04ZL	Clamped	< 10.5 mΩ	70 A

- Low capacitance and gate charge
- 100% avalanche tested
- 175 °C maximum junction temperature

Applications

- Switching applications
 - ABS, solenoid drivers
 - Motor control
 - DC-DC converters

Description

This fully clamped Power MOSFET is produced by using the latest advanced company's Mesh OVERLAY process which is based on a novel strip layout. The inherent benefits of the new technology coupled with the extra clamping capabilities make this product particularly suitable for the harshest operation conditions such as those encountered in the automotive environment. Any other application requiring extra ruggedness is also recommended.

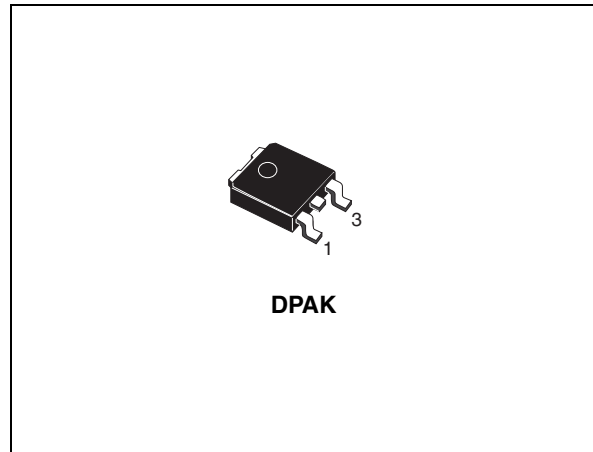

Figure 1. Internal schematic diagram

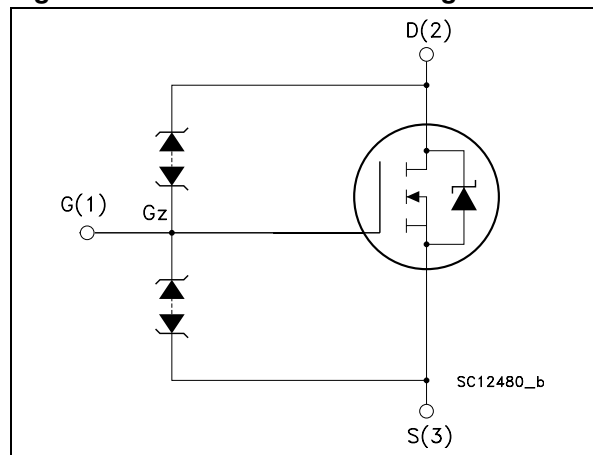

Table 1. Device summary

Order codes	Marking	Package	Packaging
STD70NS04ZL	70NS04ZL	DPAK	Tape and reel

Contents

1	Electrical ratings	3
2	Electrical characteristics	4
2.1	Electrical characteristics (curves)	6
3	Test circuits	8
4	Package mechanical data	9
5	Packaging mechanical data	11
6	Revision history	12

1 Electrical ratings

Table 2. Absolute maximum ratings

Symbol	Parameter	Value	Unit
V_{DS}	Drain-source voltage ($V_{GS} = 0$)	33 ⁽¹⁾	V
V_{DG}	drain-gate voltage	33 ⁽¹⁾	V
V_{GS}	Gate-source voltage	± 20 ⁽¹⁾	V
I_D	Drain current (continuous) at $T_C = 25\text{ }^\circ\text{C}$	70	A
I_D	Drain current (continuous) at $T_C = 100\text{ }^\circ\text{C}$	50	A
I_{DG}	Drain gate current (continuous)	± 50	mA
I_{GS}	Gate-source current (continuous)	± 50	mA
$I_{DM}^{(2)}$	Drain current (pulsed)	280	A
P_{TOT}	Total dissipation at $T_C = 25\text{ }^\circ\text{C}$	110	W
	Derating factor	0.73	W/ $^\circ\text{C}$
$V_{ESD(G-S)}$	Gate-source ESD (HBM-C=100 pF, R=1.5 k Ω)	± 8	kV
$V_{ESD(G-D)}$	Gate-drain ESD (HBM-C=100 pF, R=1.5 k Ω)	± 8	kV
$V_{ESD(D-S)}$	Drain-source ESD (HBM-C=100 pF, R=1.5 k Ω)	± 8	kV
T_J T_{stg}	Operating junction temperature Storage temperature	-55 to 175	$^\circ\text{C}$

1. Voltage is limited by zener diodes
2. Pulse width limited by safe operating area

Table 3. Thermal data

Symbol	Parameter	Value	Unit
$R_{thj-case}$	Thermal resistance junction-case max	1.36	$^\circ\text{C}/\text{W}$
$R_{thj-pcb}^{(1)}$	Thermal resistance junction-pcb max	50	$^\circ\text{C}/\text{W}$

1. When mounted on 1 inch² 2 oz. FR4 Cu.

Table 4. Avalanche data

Symbol	Parameter	Value	Unit
I_{AS}	Avalanche current, repetitive or not repetitive (pulse width limited by T_{jmax})	30	A
E_{AS}	Single pulse avalanche energy (starting $T_j = 25\text{ }^\circ\text{C}$, $I_D = I_{AS}$, $V_{DD} = 21\text{ V}$) <i>(see Figure 17, Figure 18)</i>	650	mJ

2 Electrical characteristics

($T_{CASE}=25\text{ °C}$ unless otherwise specified)

Table 5. On/off states

Symbol	Parameter	Test conditions	Min.	Typ.	Max.	Unit
$V_{(BR)DG}$	Clamped voltage	$I_D = 1\text{ mA}$, $V_{GS} = 0$ $-40 < T_j < 175\text{ °C}$	33		41	V
$V_{DSR(CL)}$	Drain-source clamping voltage (DC)	$I_{GD(CL)} = -2\text{ mA}$, $I_D = 1\text{ A}$		40		V
I_{DSS}	Zero gate voltage drain current ($V_{GS} = 0$)	$V_{DS} = 16\text{ V}$ $V_{DS} = 16\text{ V}$, $T_j = 150\text{ °C}$ $V_{DS} = 16\text{ V}$, $T_j = 175\text{ °C}$			1 50 100	μA μA μA
$I_{GSS}^{(1)}$	Gate-body leakage current ($V_{DS} = 0$)	$V_{GS} = \pm 10\text{ V}$ $V_{GS} = \pm 10\text{ V}$, $T_j = 175\text{ °C}$ $V_{GS} = \pm 15\text{ V}$, $T_j = 175\text{ °C}$			2 50 150	μA μA μA
V_{GSS}	Gate-source breakdown voltage	$I_{GS} = \pm 100\text{ }\mu\text{A}$	15			V
$V_{GS(th)}$	Gate threshold voltage	$V_{DS} = V_{GS}$, $I_D = 1\text{ mA}$	1		3	V
$R_{DS(on)}$	Static drain-source on resistance	$V_{GS} = 5\text{ V}$, $I_D = 30\text{ A}$ $V_{GS} = 10\text{ V}$, $I_D = 30\text{ A}$		9.5 7.5	12.5 10.5	$\text{m}\Omega$ $\text{m}\Omega$

1. Gate Oxide, without zener diodes, tested at wafer sorting ($I_{GSS} < \pm 100\text{ nA}$ @ $\pm 20\text{ V}$ $T_j=25\text{ °C}$) (see [Figure 17](#)) for electrical schematics

Table 6. Dynamic

Symbol	Parameter	Test conditions	Min.	Typ.	Max.	Unit
$g_{fs}^{(1)}$	Forward transconductance	$V_{DS}=15\text{ V}$, $I_D = 30\text{ A}$	-	50	-	S
C_{iss} C_{oss} C_{rss}	Input capacitance Output capacitance Reverse transfer capacitance	$V_{DS}=25\text{ V}$, $f=1\text{ MHz}$, $V_{GS}=0$	-	1800 625 220	-	pF pF pF
$t_{r(Voff)}$ t_f t_c	Off voltage rise time Fall time Cross-over time	$V_{CLAMP}=32\text{ V}$, $I_D=60\text{ A}$, $V_{GS}=10\text{ V}$, $R_G=4.7\text{ }\Omega$ (see Figure 16)	-	70 95 185	-	ns ns ns
Q_g Q_{gs} Q_{gd}	Total gate charge Gate-source charge Gate-drain charge	$V_{DD}=32\text{ V}$, $I_D = 60\text{ A}$ $V_{GS} = 5\text{ V}$ (see Figure 15)	-	32 12 17	-	nC nC nC

1. Pulsed: pulse duration=300 μs , duty cycle 1.5%

Table 7. Source drain diode

Symbol	Parameter	Test conditions	Min.	Typ.	Max.	Unit
I_{SD} $I_{SDM}^{(1)}$	Source-drain current Source-drain current (pulsed)		-		70 280	A A
$V_{SD}^{(2)}$	Forward on voltage	$I_{SD}=60\text{ A}$, $V_{GS}=0$	-		1.5	V
t_{rr} Q_{rr} I_{RRM}	Reverse recovery time Reverse recovery charge Reverse recovery current	$I_{SD}=60\text{ A}$, $di/dt = 100\text{ A}/\mu\text{s}$, $V_{DD}=25\text{ V}$, $T_j=150\text{ }^\circ\text{C}$ (see Figure 16)	-	40 40 2.3		ns nC A

1. Pulse width limited by safe operating area
2. Pulsed: pulse duration=300 μs , duty cycle 1.5%

2.1 Electrical characteristics (curves)

Figure 2. Safe operating area

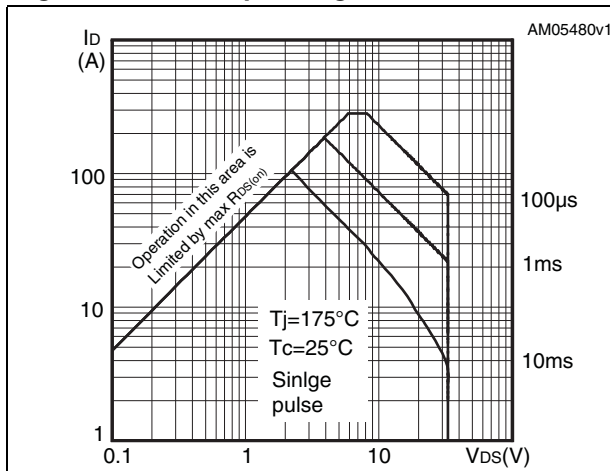

Figure 3. Thermal impedance

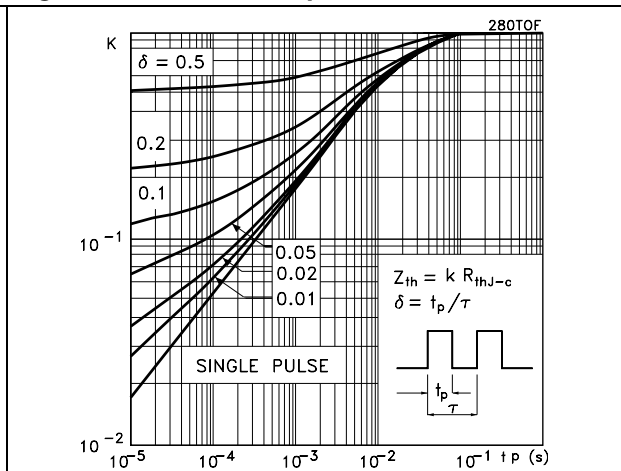

Figure 4. Output characteristics

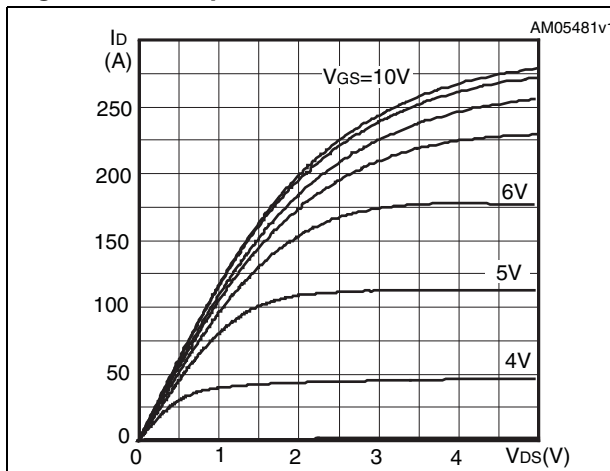

Figure 5. Transfer characteristics

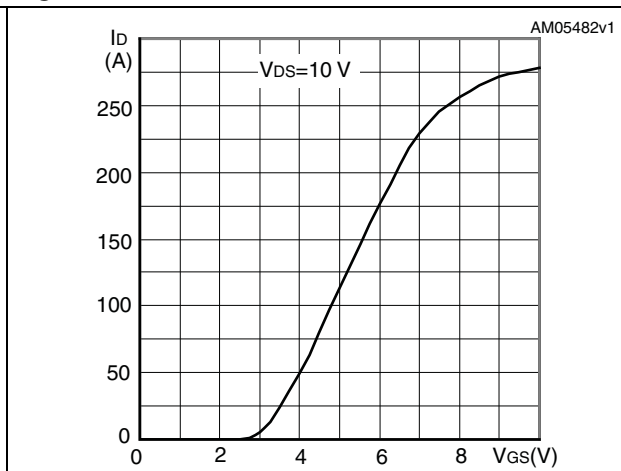

Figure 6. Normalized BV_{DSS} vs temperature

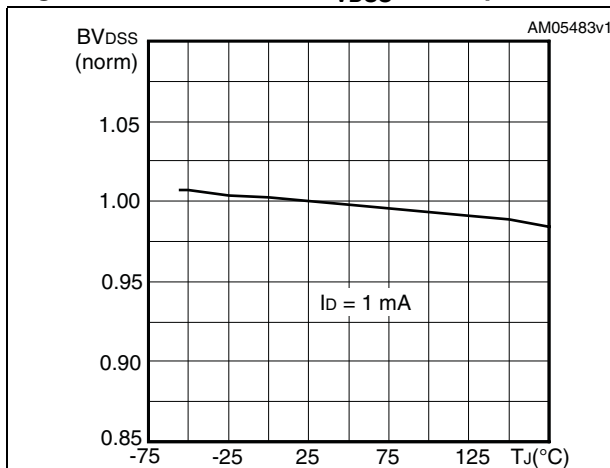

Figure 7. Static drain-source on resistance

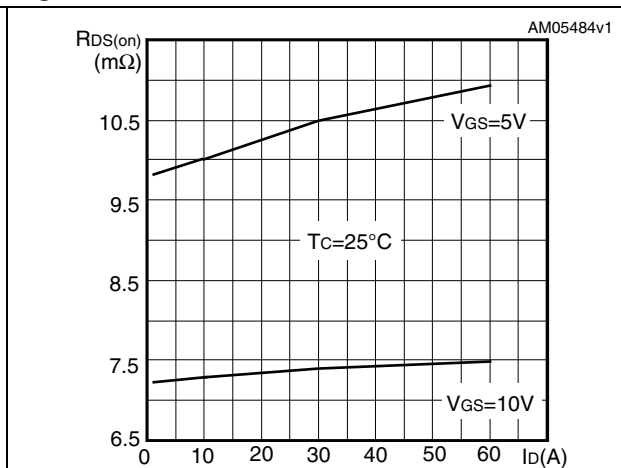

Figure 8. Gate charge vs gate-source voltage Figure 9. Capacitance variations

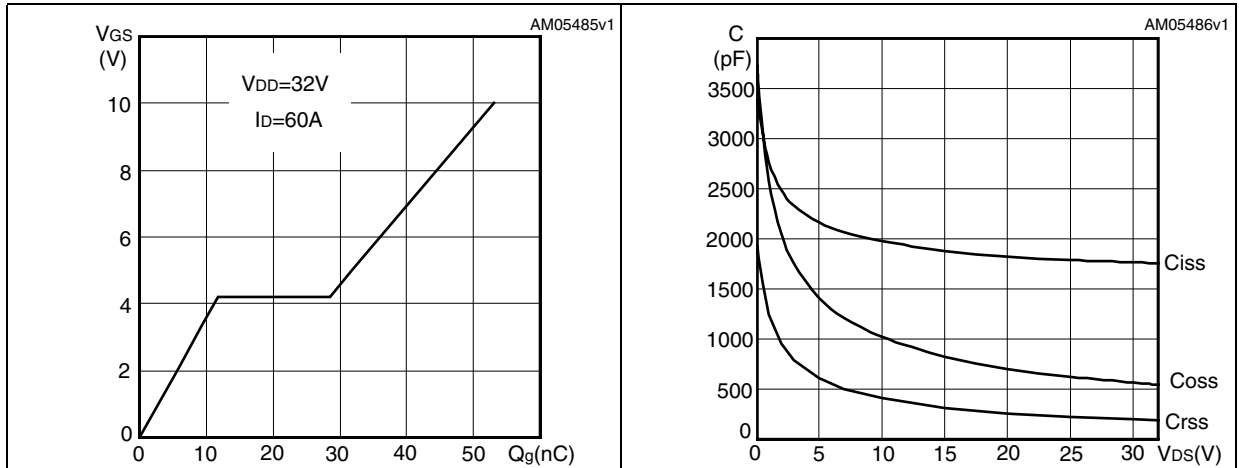

Figure 10. Normalized gate threshold voltage vs temperature Figure 11. Normalized on resistance vs temperature

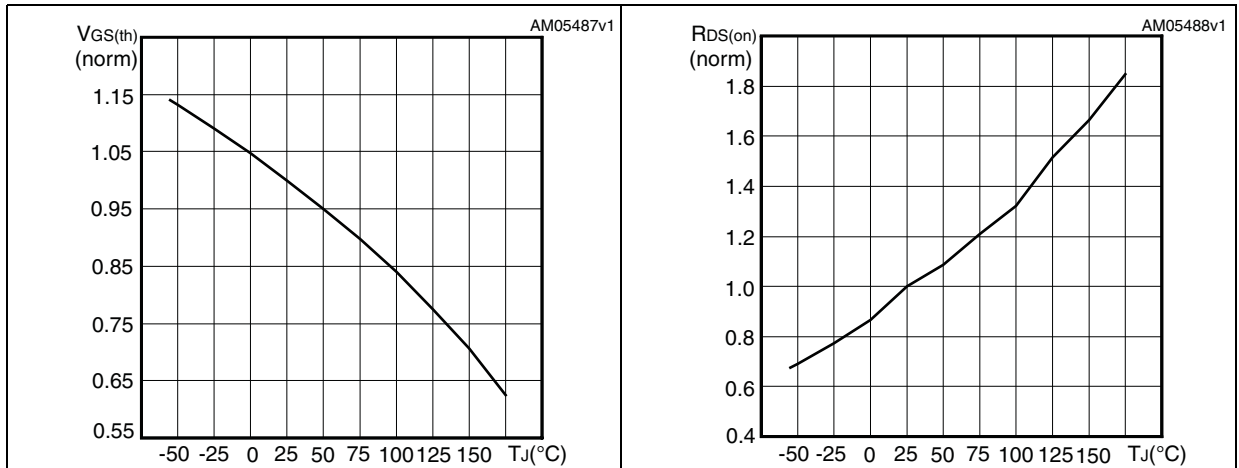
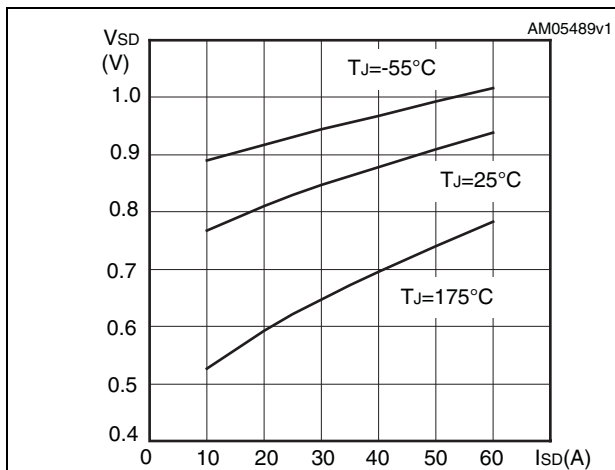

Figure 12. Source-drain diode forward characteristics



3 Test circuits

Figure 13. Switching times test circuit for resistive load



AM01468v1

Figure 14. Gate charge test circuit

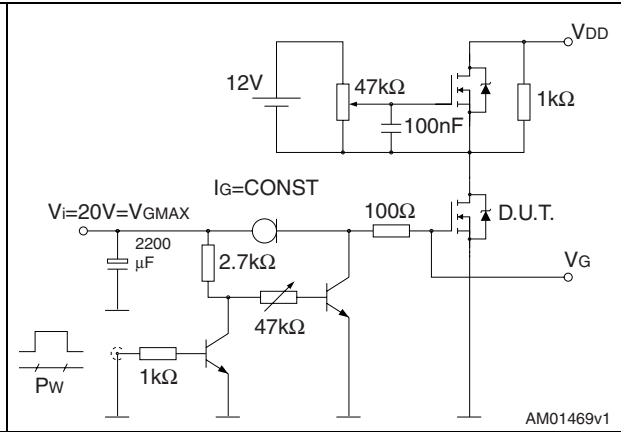

AM01469v1

Figure 15. Test circuit for inductive load switching and diode recovery times



AM01470v1

Figure 16. Unclamped inductive load test circuit

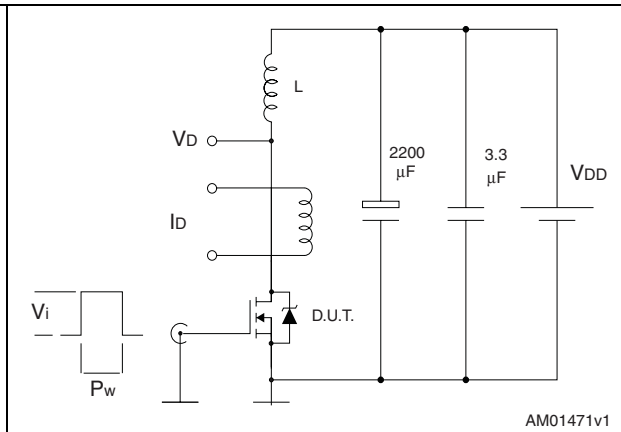

AM01471v1

Figure 17. Unclamped inductive waveform

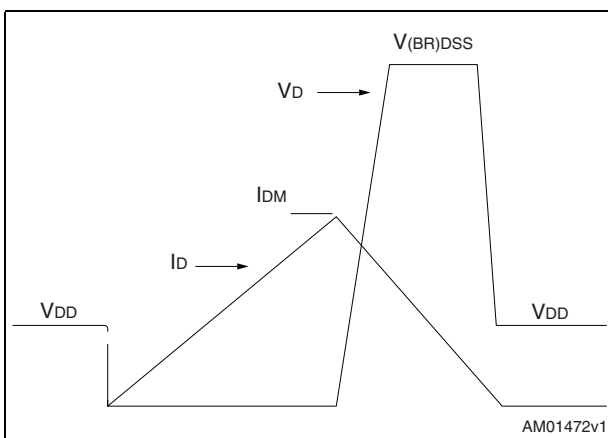

AM01472v1

Figure 18. Switching time waveform

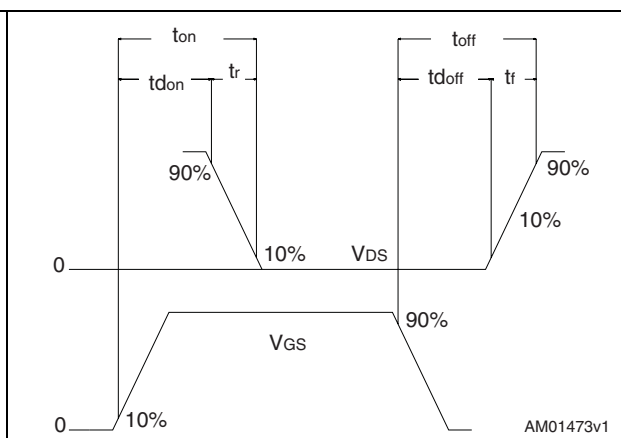

AM01473v1

4 Package mechanical data

In order to meet environmental requirements, ST offers these devices in different grades of ECOPACK® packages, depending on their level of environmental compliance. ECOPACK® specifications, grade definitions and product status are available at: www.st.com. ECOPACK is an ST trademark.

TO-252 (DPAK) mechanical data

DIM.	mm.		
	min.	typ	max.
A	2.20		2.40
A1	0.90		1.10
A2	0.03		0.23
b	0.64		0.90
b4	5.20		5.40
c	0.45		0.60
c2	0.48		0.60
D	6.00		6.20
D1		5.10	
E	6.40		6.60
E1		4.70	
e		2.28	
e1	4.40		4.60
H	9.35		10.10
L	1		
L1		2.80	
L2		0.80	
L4	0.60		1
R		0.20	
V2	0°		8°

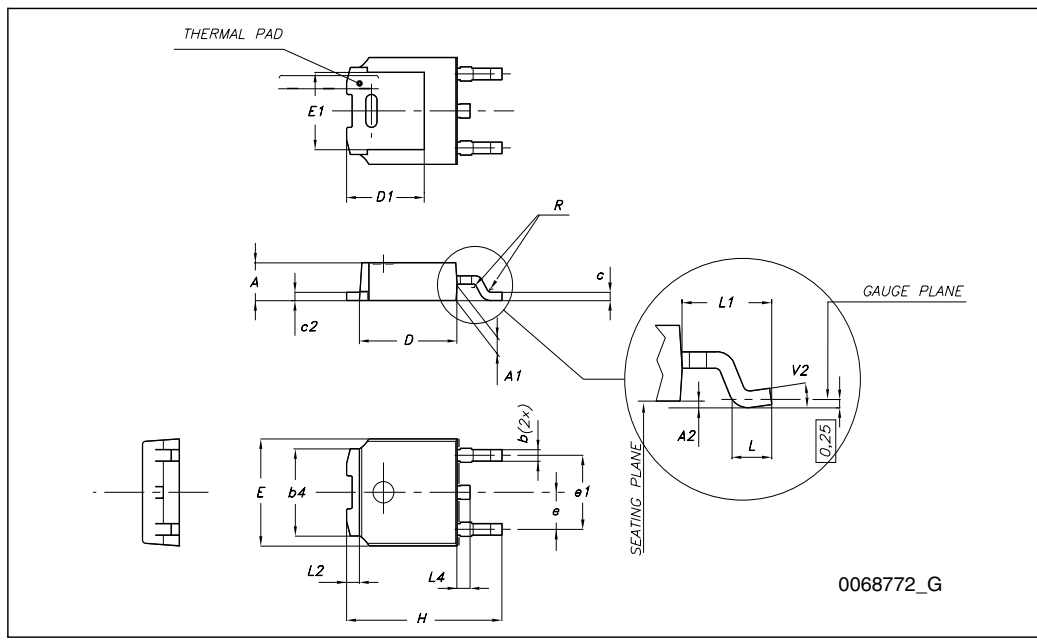

5 Packaging mechanical data

DPAK FOOTPRINT

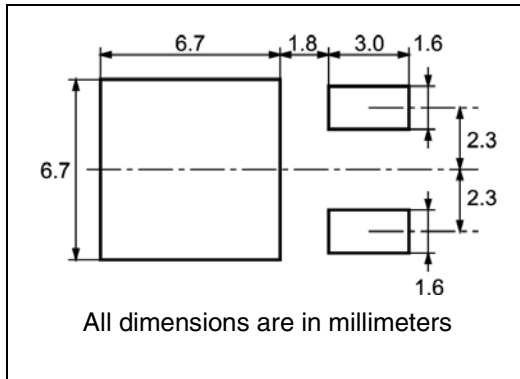

TAPE AND REEL SHIPMENT

40 mm min. Access hole at slot location

Full radius

Tape slot in core for tape start 2.5mm min. width

G measured at hub

REEL MECHANICAL DATA

DIM.	mm		inch	
	MIN.	MAX.	MIN.	MAX.
A		330		12.992
B	1.5		0.059	
C	12.8	13.2	0.504	0.520
D	20.2		0.795	
G	16.4	18.4	0.645	0.724
N	50		1.968	
T		22.4		0.881

TAPE MECHANICAL DATA

DIM.	mm		inch	
	MIN.	MAX.	MIN.	MAX.
A0	6.8	7	0.267	0.275
B0	10.4	10.6	0.409	0.417
B1		12.1		0.476
D	1.5	1.6	0.059	0.063
D1	1.5		0.059	
E	1.65	1.85	0.065	0.073
F	7.4	7.6	0.291	0.299
K0	2.55	2.75	0.100	0.108
P0	3.9	4.1	0.153	0.161
P1	7.9	8.1	0.311	0.319
P2	1.9	2.1	0.075	0.082
R	40		1.574	
W	15.7	16.3	0.618	0.641

BASE QTY

2500

BULK QTY

2500

10 pitches cumulative tolerance on tape +/- 0.2 mm

User Direction of Feed

Center line of cavity

TRL

FEED DIRECTION

Bending radius R min.

6 Revision history

Table 8. Document revision history

Date	Revision	Changes
01-Oct-2009	1	First release

Please Read Carefully:

Information in this document is provided solely in connection with ST products. STMicroelectronics NV and its subsidiaries ("ST") reserve the right to make changes, corrections, modifications or improvements, to this document, and the products and services described herein at any time, without notice.

All ST products are sold pursuant to ST's terms and conditions of sale.

Purchasers are solely responsible for the choice, selection and use of the ST products and services described herein, and ST assumes no liability whatsoever relating to the choice, selection or use of the ST products and services described herein.

No license, express or implied, by estoppel or otherwise, to any intellectual property rights is granted under this document. If any part of this document refers to any third party products or services it shall not be deemed a license grant by ST for the use of such third party products or services, or any intellectual property contained therein or considered as a warranty covering the use in any manner whatsoever of such third party products or services or any intellectual property contained therein.

UNLESS OTHERWISE SET FORTH IN ST'S TERMS AND CONDITIONS OF SALE ST DISCLAIMS ANY EXPRESS OR IMPLIED WARRANTY WITH RESPECT TO THE USE AND/OR SALE OF ST PRODUCTS INCLUDING WITHOUT LIMITATION IMPLIED WARRANTIES OF MERCHANTABILITY, FITNESS FOR A PARTICULAR PURPOSE (AND THEIR EQUIVALENTS UNDER THE LAWS OF ANY JURISDICTION), OR INFRINGEMENT OF ANY PATENT, COPYRIGHT OR OTHER INTELLECTUAL PROPERTY RIGHT.

UNLESS EXPRESSLY APPROVED IN WRITING BY AN AUTHORIZED ST REPRESENTATIVE, ST PRODUCTS ARE NOT RECOMMENDED, AUTHORIZED OR WARRANTED FOR USE IN MILITARY, AIR CRAFT, SPACE, LIFE SAVING, OR LIFE SUSTAINING APPLICATIONS, NOR IN PRODUCTS OR SYSTEMS WHERE FAILURE OR MALFUNCTION MAY RESULT IN PERSONAL INJURY, DEATH, OR SEVERE PROPERTY OR ENVIRONMENTAL DAMAGE. ST PRODUCTS WHICH ARE NOT SPECIFIED AS "AUTOMOTIVE GRADE" MAY ONLY BE USED IN AUTOMOTIVE APPLICATIONS AT USER'S OWN RISK.

Resale of ST products with provisions different from the statements and/or technical features set forth in this document shall immediately void any warranty granted by ST for the ST product or service described herein and shall not create or extend in any manner whatsoever, any liability of ST.

ST and the ST logo are trademarks or registered trademarks of ST in various countries.

Information in this document supersedes and replaces all information previously supplied.

The ST logo is a registered trademark of STMicroelectronics. All other names are the property of their respective owners.

© 2009 STMicroelectronics - All rights reserved

STMicroelectronics group of companies

Australia - Belgium - Brazil - Canada - China - Czech Republic - Finland - France - Germany - Hong Kong - India - Israel - Italy - Japan - Malaysia - Malta - Morocco - Philippines - Singapore - Spain - Sweden - Switzerland - United Kingdom - United States of America

www.st.com

X-ON Electronics

Largest Supplier of Electrical and Electronic Components

Click to view similar products for [MOSFET](#) category:

Click to view products by [STMicroelectronics](#) manufacturer:

Other Similar products are found below :

[614233C](#) [648584F](#) [IRFD120](#) [JANTX2N5237](#) [FCA20N60_F109](#) [FDZ595PZ](#) [2SK2545\(Q,T\)](#) [405094E](#) [423220D](#) [TPCC8103,L1Q\(CM](#)
[MIC4420CM-TR](#) [VN1206L](#) [SBVS138LT1G](#) [614234A](#) [715780A](#) [NTNS3166NZT5G](#) [SSM6J414TU,LF\(T](#) [751625C](#) [BUK954R8-60E](#)
[NTE6400](#) [SQJ402EP-T1-GE3](#) [2SK2614\(TE16L1,Q\)](#) [2N7002KW-FAI](#) [DMN1017UCP3-7](#) [EFC2J004NUZTDG](#) [ECH8691-TL-W](#)
[FCAB21350L1](#) [P85W28HP2F-7071](#) [DMN1053UCP4-7](#) [NTE221](#) [NTE2384](#) [NTE2903](#) [NTE2941](#) [NTE2945](#) [NTE2946](#) [NTE2960](#) [NTE2967](#)
[NTE2969](#) [NTE2976](#) [NTE455](#) [NTE6400A](#) [NTE2910](#) [NTE2916](#) [NTE2956](#) [NTE2911](#) [DMN2080UCB4-7](#) [TK10A80W,S4X\(S](#)
[SSM6P69NU,LF](#) [DMP22D4UFO-7B](#) [DMN1006UCA6-7](#)