

N-channel 600 V, 0.55 Ω typ., 7.5 A MDmesh M2 Power MOSFET in a TO-220FP package

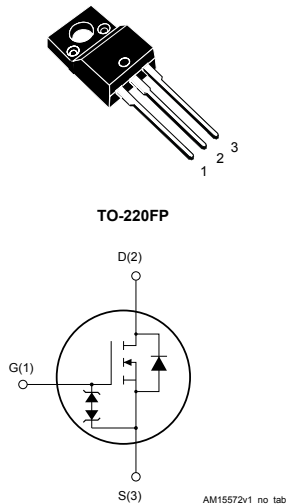

Features

Order code	V_{DS} at T_{Jmax} .	$R_{DS(on)}$ max.	I_D
STF10N60M2	650 V	0.60 Ω	7.5 A

- Extremely low gate charge
- Excellent output capacitance (C_{oss}) profile
- 100% avalanche tested
- Zener-protected

Applications

- Switching applications

Description

This device is an N-channel Power MOSFET developed using MDmesh M2 technology. Thanks to its strip layout and an improved vertical structure, the device exhibits low on-resistance and optimized switching characteristics, rendering it suitable for the most demanding high efficiency converters.



Product status link

[STF10N60M2](#)

Product summary

Order code	STF10N60M2
Marking	10N60M2
Package	TO-220FP
Packing	Tube

1 Electrical ratings

Table 1. Absolute maximum ratings

Symbol	Parameter	Value	Unit
V_{GS}	Gate-source voltage	±25	V
$I_D^{(1)}$	Drain current (continuous) at $T_C = 25\text{ °C}$	7.5	A
	Drain current (continuous) at $T_C = 100\text{ °C}$	4.9	
$I_{DM}^{(2)}$	Drain current (pulsed)	30	A
P_{TOT}	Total power dissipation at $T_C = 25\text{ °C}$	25	W
$dv/dt^{(3)}$	Peak diode recovery voltage slope	15	V/ns
$dv/dt^{(4)}$	MOSFET dv/dt ruggedness	50	
$V_{ISO}^{(5)}$	Insulation withstand voltage (RMS) from all three leads to external heat sink	2500	V
T_{stg}	Storage temperature range	-55 to 150	°C
T_j	Operating junction temperature range		

- Limited by package.
- Pulse limited by safe operating area.
- $I_{SD} \leq 7.5\text{ A}$, $di/dt \leq 400\text{ A}/\mu\text{s}$; $V_{DS\text{ peak}} < V_{(BR)DSS}$, $V_{DD} = 400\text{ V}$
- $V_{DS} \leq 480\text{ V}$.
- $t = 1\text{ s}$; $T_C = 25\text{ °C}$.

Table 2. Thermal data

Symbol	Parameter	Value	Unit
R_{thJC}	Thermal resistance, junction-to-case	5	°C/W
R_{thJA}	Thermal resistance, junction-to-ambient	62.5	

Table 3. Avalanche characteristics

Symbol	Parameter	Value	Unit
$I_{AR}^{(1)}$	Avalanche current, repetitive or not repetitive	1.5	A
$E_{AS}^{(2)}$	Single pulse avalanche energy	110	mJ

- Pulse width limited by T_{jmax} .
- Starting $T_j = 25\text{ °C}$, $I_D = I_{AR}$, $V_{DD} = 50\text{ V}$.

2 Electrical characteristics

($T_{\text{case}} = 25\text{ °C}$ unless otherwise specified)

Table 4. Static

Symbol	Parameter	Test conditions	Min.	Typ.	Max.	Unit
$V_{(\text{BR})\text{DSS}}$	Drain-source breakdown voltage	$V_{\text{GS}} = 0\text{ V}$, $I_{\text{D}} = 1\text{ mA}$	600			V
I_{DSS}	Zero gate voltage drain current	$V_{\text{GS}} = 0\text{ V}$, $V_{\text{DS}} = 600\text{ V}$			1	μA
		$V_{\text{GS}} = 0\text{ V}$, $V_{\text{DS}} = 600\text{ V}$, $T_{\text{case}} = 125\text{ °C}^{(1)}$			100	
I_{GSS}	Gate-body leakage current	$V_{\text{DS}} = 0\text{ V}$, $V_{\text{GS}} = \pm 25\text{ V}$			± 10	μA
$V_{\text{GS}(\text{th})}$	Gate threshold voltage	$V_{\text{DS}} = V_{\text{GS}}$, $I_{\text{D}} = 250\text{ }\mu\text{A}$	2	3	4	V
$R_{\text{DS}(\text{on})}$	Static drain-source on-resistance	$V_{\text{GS}} = 10\text{ V}$, $I_{\text{D}} = 3\text{ A}$		0.55	0.60	Ω

1. Defined by design, not subject to production test.

Table 5. Dynamic

Symbol	Parameter	Test conditions	Min.	Typ.	Max.	Unit
C_{iSS}	Input capacitance	$V_{\text{DS}} = 100\text{ V}$, $f = 1\text{ MHz}$, $V_{\text{GS}} = 0\text{ V}$	-	400	-	pF
C_{oSS}	Output capacitance		-	22	-	
C_{rSS}	Reverse transfer capacitance		-	0.84	-	
$C_{\text{oSS eq.}}^{(1)}$	Equivalent output capacitance	$V_{\text{DS}} = 0\text{ to }480\text{ V}$, $V_{\text{GS}} = 0\text{ V}$	-	83	-	pF
R_{G}	Intrinsic gate resistance	$f = 1\text{ MHz}$, $I_{\text{D}} = 0\text{ A}$	-	6.4	-	Ω
Q_{g}	Total gate charge	$V_{\text{DD}} = 480\text{ V}$, $I_{\text{D}} = 7.5\text{ A}$, $V_{\text{GS}} = 0\text{ to }10\text{ V}$ (see Figure 14. Test circuit for gate charge behavior)	-	13.5	-	nC
Q_{gs}	Gate-source charge		-	2.1	-	
Q_{gd}	Gate-drain charge		-	7.2	-	

1. $C_{\text{oSS eq.}}$ is defined as a constant equivalent capacitance giving the same charging time as C_{oSS} when V_{DS} increases from 0 to 80% V_{DSS} .

Table 6. Switching times

Symbol	Parameter	Test conditions	Min.	Typ.	Max.	Unit
$t_{\text{d}(\text{on})}$	Turn-on delay time	$V_{\text{DD}} = 300\text{ V}$, $I_{\text{D}} = 3.75\text{ A}$, $R_{\text{G}} = 4.7\text{ }\Omega$, $V_{\text{GS}} = 10\text{ V}$ (see Figure 13. Test circuit for resistive load switching times and Figure 18. Switching time waveform)	-	8.8	-	ns
t_{r}	Rise time		-	8	-	
$t_{\text{d}(\text{off})}$	Turn-off delay time		-	32.5	-	
t_{f}	Fall time		-	13.2	-	

Table 7. Source-drain diode

Symbol	Parameter	Test conditions	Min.	Typ.	Max.	Unit
$I_{SD}^{(1)}$	Source-drain current		-		7.5	A
$I_{SDM}^{(2)}$	Source-drain current (pulsed)		-		30	A
$V_{SD}^{(3)}$	Forward on voltage	$V_{GS} = 0\text{ V}, I_{SD} = 7.5\text{ A}$	-		1.6	V
t_{rr}	Reverse recovery time	$I_{SD} = 7.5\text{ A}, di/dt = 100\text{ A}/\mu\text{s}, V_{DD} = 60\text{ V}$ (see) Figure 15. Test circuit for inductive load switching and diode recovery times	-	270		ns
Q_{rr}	Reverse recovery charge		-	2		μC
I_{RRM}	Reverse recovery current		-	14.4		A
t_{rr}	Reverse recovery time	$I_{SD} = 7.5\text{ A}, di/dt = 100\text{ A}/\mu\text{s}, V_{DD} = 60\text{ V}, T_j = 150\text{ }^\circ\text{C}$ (see) Figure 15. Test circuit for inductive load switching and diode recovery times	-	376		ns
Q_{rr}	Reverse recovery charge		-	2.8		μC
I_{RRM}	Reverse recovery current		-	15		A

1. Limited by package.
2. Pulse width is limited by safe operating area.
3. Pulse test: pulse duration = 300 μs , duty cycle 1.5%.

2.1 Electrical characteristics curves

Figure 1. Safe operating area

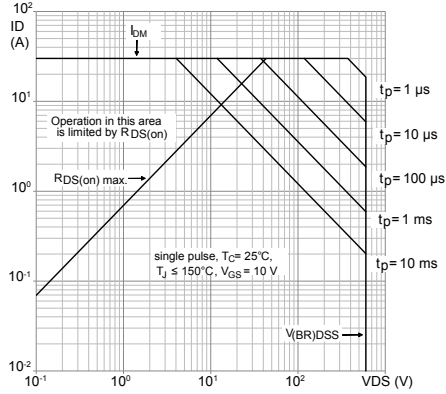

Figure 2. Maximum transient thermal impedance

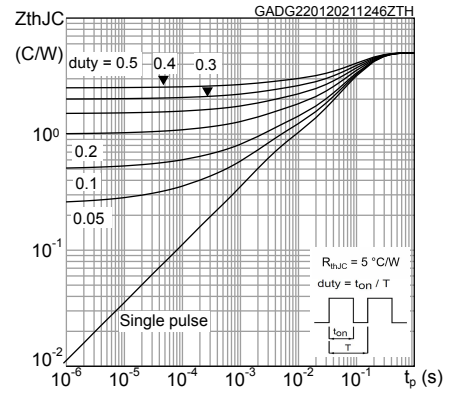

Figure 3. Output characteristics

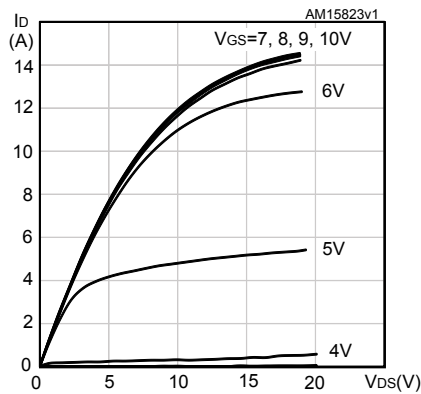

Figure 4. Transfer characteristics

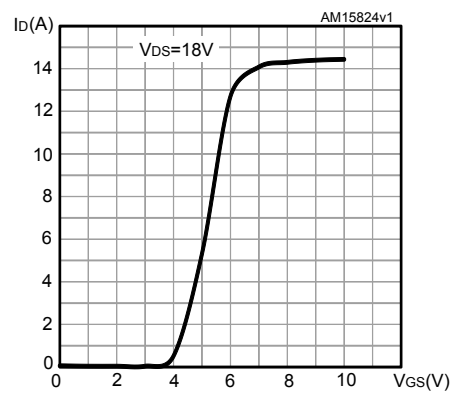

Figure 5. Gate charge vs gate-source voltage

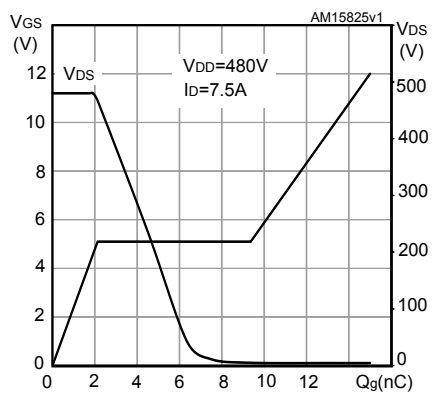

Figure 6. Static drain-source on-resistance

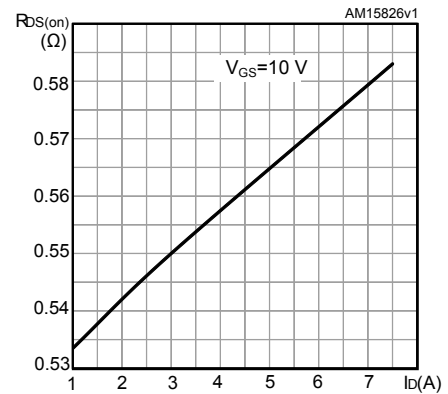

Figure 7. Capacitance variations

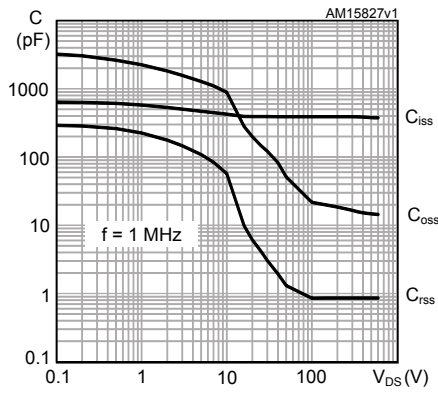

Figure 8. Normalized gate threshold voltage vs temperature

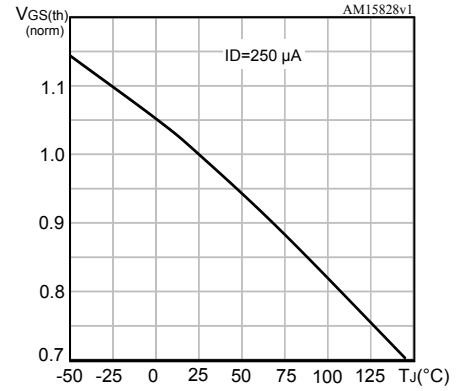

Figure 9. Normalized on-resistance vs temperature

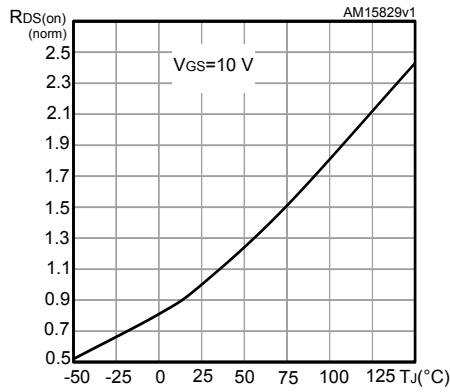

Figure 10. Normalized V_{(BR)DSS} vs temperature

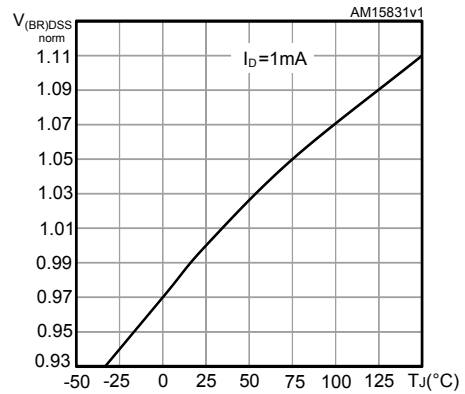

Figure 11. Source-drain diode forward characteristics

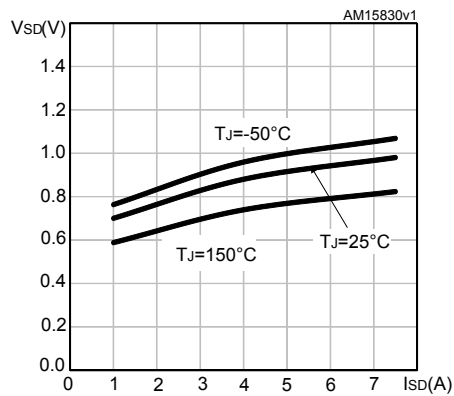
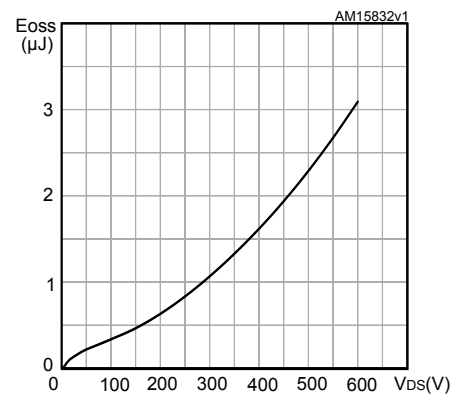
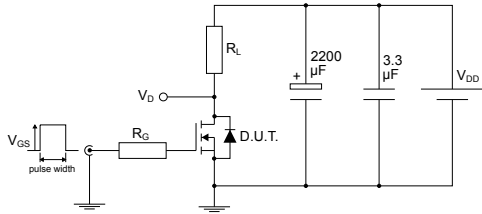

Figure 12. Output capacitance stored energy



3 Test circuits

Figure 13. Test circuit for resistive load switching times

AM01468v1

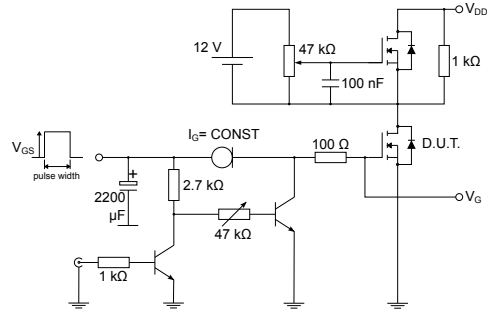
Figure 14. Test circuit for gate charge behavior

AM01469v1

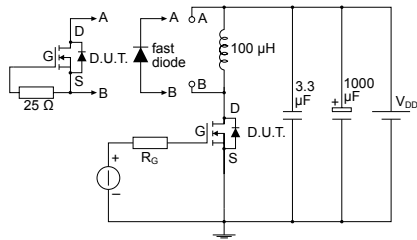
Figure 15. Test circuit for inductive load switching and diode recovery times

AM01470v1

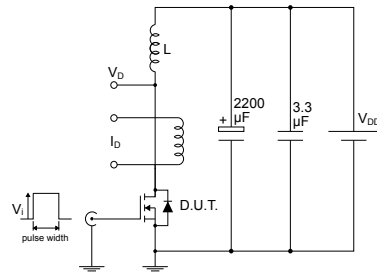
Figure 16. Unclamped inductive load test circuit

AM01471v1

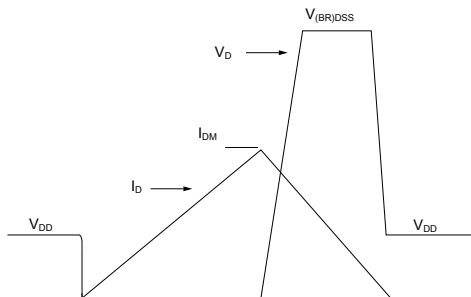
Figure 17. Unclamped inductive waveform

AM01472v1

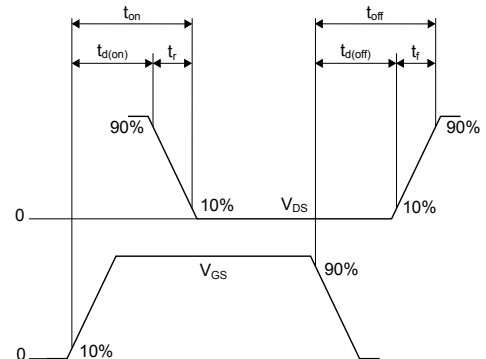
Figure 18. Switching time waveform

AM01473v1

4 Package information

In order to meet environmental requirements, ST offers these devices in different grades of **ECOPACK** packages, depending on their level of environmental compliance. ECOPACK specifications, grade definitions and product status are available at: www.st.com. ECOPACK is an ST trademark.

4.1 TO-220FP package information

Figure 19. TO-220FP package outline

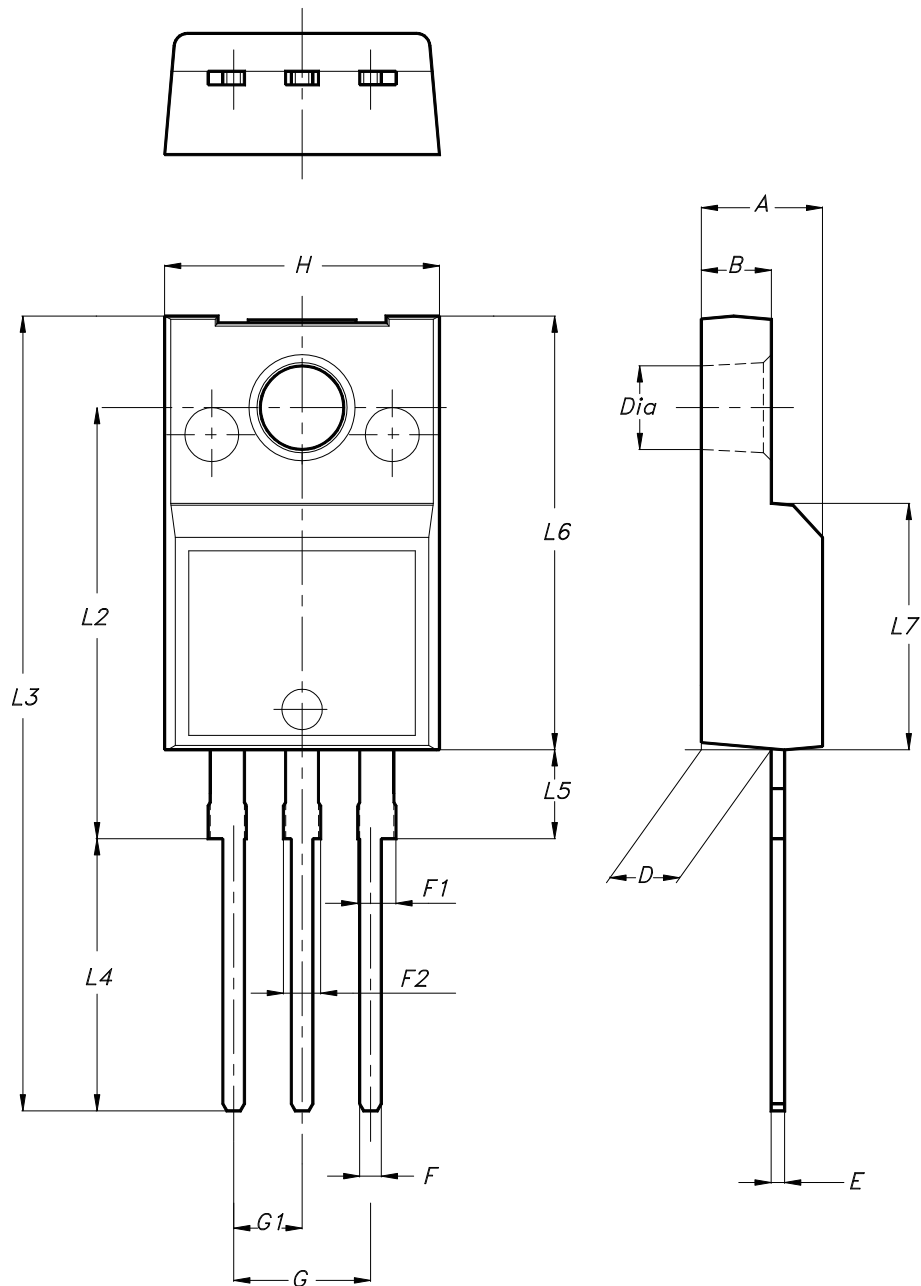

7012510_Rev_13_B

Table 8. TO-220FP package mechanical data

Dim.	mm		
	Min.	Typ.	Max.
A	4.40		4.60
B	2.50		2.70
D	2.50		2.75
E	0.45		0.70
F	0.75		1.00
F1	1.15		1.70
F2	1.15		1.70
G	4.95		5.20
G1	2.40		2.70
H	10.00		10.40
L2		16.00	
L3	28.60		30.60
L4	9.80		10.60
L5	2.90		3.60
L6	15.90		16.40
L7	9.00		9.30
Dia	3.00		3.20

Revision history

Table 9. Document revision history

Date	Revision	Changes
29-May-2013	1	First release.
14-Oct-2013	2	Modified: R_G value in <i>Table 6</i> Minor text changes
06-Dec-2013	3	Added: I ² PAKFP package – Modified: title – Modified: $R_{DS(on)}$ typical values in <i>Table 5</i> – Modified: R_G value in <i>Table 6</i> – Modified: <i>Figure 7</i> and I_D value in <i>Figure 10</i> – Added: <i>Table 10</i> , and <i>Figure 21</i> – Minor text changes
09-Mar-2017	4	The part number STF10N60M2 has been moved to a separate datasheet and this document has been updated accordingly. Updated the title and the description in cover page. Updated <i>Table 3. Avalanche characteristics</i> . Minor text changes.
01-Feb-2021	5	Updated <i>Figure 1</i> and <i>Figure 2</i> . Minor text changes.

Contents

1	Electrical ratings	2
2	Electrical characteristics	3
2.1	Electrical characteristics curves	5
3	Test circuits	7
4	Package information	8
4.1	TO-220FP package information	8
	Revision history	10

IMPORTANT NOTICE – PLEASE READ CAREFULLY

STMicroelectronics NV and its subsidiaries (“ST”) reserve the right to make changes, corrections, enhancements, modifications, and improvements to ST products and/or to this document at any time without notice. Purchasers should obtain the latest relevant information on ST products before placing orders. ST products are sold pursuant to ST’s terms and conditions of sale in place at the time of order acknowledgement.

Purchasers are solely responsible for the choice, selection, and use of ST products and ST assumes no liability for application assistance or the design of Purchasers’ products.

No license, express or implied, to any intellectual property right is granted by ST herein.

Resale of ST products with provisions different from the information set forth herein shall void any warranty granted by ST for such product.

ST and the ST logo are trademarks of ST. For additional information about ST trademarks, please refer to www.st.com/trademarks. All other product or service names are the property of their respective owners.

Information in this document supersedes and replaces information previously supplied in any prior versions of this document.

© 2021 STMicroelectronics – All rights reserved

X-ON Electronics

Largest Supplier of Electrical and Electronic Components

Click to view similar products for [MOSFET](#) category:

Click to view products by [STMicroelectronics](#) manufacturer:

Other Similar products are found below :

[614233C](#) [648584F](#) [IRFD120](#) [JANTX2N5237](#) [FCA20N60_F109](#) [FDZ595PZ](#) [2SK2545\(Q,T\)](#) [405094E](#) [423220D](#) [TPCC8103,L1Q\(CM](#)
[MIC4420CM-TR](#) [VN1206L](#) [SBVS138LT1G](#) [614234A](#) [715780A](#) [NTNS3166NZT5G](#) [SSM6J414TU,LF\(T](#) [751625C](#) [BUK954R8-60E](#)
[DMN3404LQ-7](#) [NTE6400](#) [SQJ402EP-T1-GE3](#) [2SK2614\(TE16L1,Q\)](#) [2N7002KW-FAI](#) [DMN1017UCP3-7](#) [EFC2J004NUZTDG](#) [ECH8691-](#)
[TL-W](#) [FCAB21350L1](#) [P85W28HP2F-7071](#) [DMN1053UCP4-7](#) [NTE221](#) [NTE2384](#) [NTE2903](#) [NTE2941](#) [NTE2945](#) [NTE2946](#) [NTE2960](#)
[NTE2967](#) [NTE2969](#) [NTE2976](#) [NTE455](#) [NTE6400A](#) [NTE2910](#) [NTE2916](#) [NTE2956](#) [NTE2911](#) [DMN2080UCB4-7](#) [TK10A80W,S4X\(S](#)
[SSM6P69NU,LF](#) [DMP22D4UFO-7B](#)