

## N-channel 600 V, 165 mΩ typ., 18 A, MDmesh DM6 Power MOSFET in a TO-220FP package

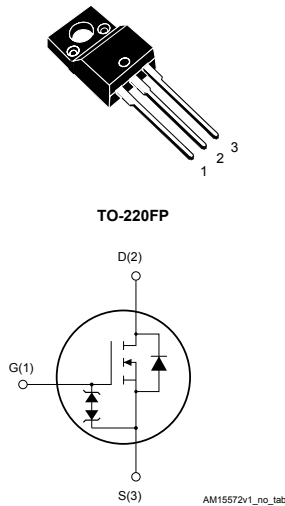

### Features

Order code	$V_{DS}$	$R_{DS(on)}$ max.	$I_D$
STF26N60DM6	600 V	195 mΩ	18 A

- Fast-recovery body diode
- Lower  $R_{DS(on)}$  per area vs previous generation
- Low gate charge, input capacitance and resistance
- 100% avalanche tested
- Extremely high dv/dt ruggedness
- Zener-protected

### Applications

- Switching applications

### Description

This high-voltage N-channel Power MOSFET is part of the MDmesh DM6 fast-recovery diode series. Compared with the previous MDmesh fast generation, DM6 combines very low recovery charge ( $Q_{rr}$ ), recovery time ( $t_{rr}$ ) and excellent improvement in  $R_{DS(on)}$  per area with one of the most effective switching behaviors available in the market for the most demanding high-efficiency bridge topologies and ZVS phase-shift converters.



#### Product status link

[STF26N60DM6](#)

#### Product summary

<b>Order code</b>	STF26N60DM6
<b>Marking</b>	26N60DM6
<b>Package</b>	TO-220FP
<b>Packing</b>	Tube

# 1 Electrical ratings

**Table 1. Absolute maximum ratings**

Symbol	Parameter	Value	Unit
$V_{GS}$	Gate-source voltage	$\pm 25$	V
$I_D$	Drain current (continuous) at $T_C = 25\text{ }^\circ\text{C}$	18	A
	Drain current (continuous) at $T_C = 100\text{ }^\circ\text{C}$	11	A
$I_{DM}^{(1)}$	Drain current (pulsed)	60	A
$P_{TOT}$	Total power dissipation at $T_C = 25\text{ }^\circ\text{C}$	30	W
$dv/dt^{(2)}$	Peak diode recovery voltage slope	100	V/ns
$di/dt^{(2)}$	Peak diode recovery current slope	1000	A/ $\mu\text{s}$
$dv/dt^{(3)}$	MOSFET $dv/dt$ ruggedness	100	V/ns
$V_{ISO}$	Insulation withstand voltage (RMS) from all three leads to external heat sink ( $t = 1\text{ s}$ , $T_C = 25\text{ }^\circ\text{C}$ )	2.5	kV
$T_{stg}$	Storage temperature range	-55 to 150	$^\circ\text{C}$
$T_J$	Operating junction temperature range		

1. Pulse width is limited by safe operating area.
2.  $I_{SD} \leq 18\text{ A}$ ,  $V_{DS} (\text{peak}) < V_{(BR)DSS}$ ,  $V_{DD} = 400\text{ V}$ .
3.  $V_{DS} \leq 480\text{ V}$

**Table 2. Thermal data**

Symbol	Parameter	Value	Unit
$R_{thj-case}$	Thermal resistance junction-case	4.17	$^\circ\text{C/W}$
$R_{thj-amb}^{(1)}$	Thermal resistance junction-ambient	50	$^\circ\text{C/W}$

1. When mounted on FR-4 board of  $\text{inch}^2$ , 2oz Cu.

**Table 3. Avalanche characteristics**

Symbol	Parameter	Value	Unit
$I_{AR}$	Avalanche current, repetitive or not repetitive (pulse width limited by $T_{Jmax}$ )	4	A
$E_{AS}$	Single pulse avalanche energy (starting $T_J = 25\text{ }^\circ\text{C}$ , $I_D = I_{AR}$ , $V_{DD} = 50\text{ V}$ )	360	mJ

## 2 Electrical characteristics

$T_C = 25\text{ °C}$  unless otherwise specified

**Table 4. On/off states**

Symbol	Parameter	Test conditions	Min.	Typ.	Max.	Unit
$V_{(BR)DSS}$	Drain-source breakdown voltage	$V_{GS} = 0\text{ V}, I_D = 1\text{ mA}$	600			V
$I_{DSS}$	Zero gate voltage drain current	$V_{GS} = 0\text{ V}, V_{DS} = 600\text{ V}$			1	$\mu\text{A}$
		$V_{GS} = 0\text{ V}, V_{DS} = 600\text{ V},$ $T_C = 125\text{ °C}^{(1)}$			100	$\mu\text{A}$
$I_{GSS}$	Gate-body leakage current	$V_{DS} = 0\text{ V}, V_{GS} = \pm 25\text{ V}$			$\pm 5$	$\mu\text{A}$
$V_{GS(th)}$	Gate threshold voltage	$V_{DS} = V_{GS}, I_D = 250\text{ }\mu\text{A}$	3.25	4	4.75	V
$R_{DS(on)}$	Static drain-source on-resistance	$V_{GS} = 10\text{ V}, I_D = 9\text{ A}$		165	195	$\text{m}\Omega$

1. Defined by design, not subject to production test.

**Table 5. Dynamic**

Symbol	Parameter	Test conditions	Min.	Typ.	Max.	Unit
$C_{iss}$	Input capacitance	$V_{DS} = 100\text{ V}, f = 1\text{ MHz},$ $V_{GS} = 0\text{ V}$	-	940	-	$\text{pF}$
$C_{oss}$	Output capacitance		-	75	-	$\text{pF}$
$C_{riss}$	Reverse transfer capacitance		-	4	-	$\text{pF}$
$C_{oss\text{ eq.}}^{(1)}$	Equivalent output capacitance	$V_{DS} = 0\text{ to }480\text{ V}, V_{GS} = 0\text{ V}$	-	157	-	$\text{pF}$
$R_G$	Intrinsic gate resistance	$f = 1\text{ MHz}, I_D = 0\text{ A}$	-	4.8	-	$\Omega$
$Q_g$	Total gate charge	$V_{DD} = 480\text{ V}, I_D = 18\text{ A},$ $V_{GS} = 0\text{ to }10\text{ V}$ (see Figure 14. Test circuit for gate charge behavior)	-	24	-	$\text{nC}$
$Q_{gs}$	Gate-source charge		-	6	-	$\text{nC}$
$Q_{gd}$	Gate-drain charge		-	11.5	-	$\text{nC}$

1.  $C_{oss\text{ eq.}}$  is defined as a constant equivalent capacitance giving the same charging time as  $C_{oss}$  when  $V_{DS}$  increases from 0 to 80%  $V_{DSS}$ .

**Table 6. Switching times**

Symbol	Parameter	Test conditions	Min.	Typ.	Max.	Unit
$t_{d(on)}$	Turn-on delay time	$V_{DD} = 300\text{ V}, I_D = 9\text{ A},$ $R_G = 4.7\text{ }\Omega, V_{GS} = 10\text{ V}$	-	13	-	ns
$t_r$	Rise time		-	11	-	ns
$t_{d(off)}$	Turn-off delay time	(see Figure 13. Test circuit for resistive load switching times and Figure 18. Switching time waveform)	-	39	-	ns
$t_f$	Fall time		-	8	-	ns

**Table 7. Source drain diode**

Symbol	Parameter	Test conditions	Min.	Typ.	Max.	Unit
$I_{SD}$	Source-drain current		-		18	A
$I_{SDM}^{(1)}$	Source-drain current (pulsed)		-		60	A
$V_{SD}^{(2)}$	Forward on voltage	$V_{GS} = 0\text{ V}$ , $I_{SD} = 18\text{ A}$	-		1.6	V
$t_{rr}$	Reverse recovery time	$I_{SD} = 18\text{ A}$ , $di/dt = 100\text{ A}/\mu\text{s}$ , $V_{DD} = 60\text{ V}$	-	100		ns
$Q_{rr}$	Reverse recovery charge		-	0.35		$\mu\text{C}$
$I_{RRM}$	Reverse recovery current	(see Figure 15. Test circuit for inductive load switching and diode recovery times)	-	7		A
$t_{rr}$	Reverse recovery time	$I_{SD} = 18\text{ A}$ , $di/dt = 100\text{ A}/\mu\text{s}$ , $V_{DD} = 60\text{ V}$ , $T_j = 150\text{ }^\circ\text{C}$	-	170		ns
$Q_{rr}$	Reverse recovery charge		-	1.02		$\mu\text{C}$
$I_{RRM}$	Reverse recovery current		(see Figure 15. Test circuit for inductive load switching and diode recovery times)	-	12	

1. Pulse width is limited by safe operating area.
2. Pulsed: pulse duration = 300  $\mu\text{s}$ , duty cycle 1.5 %.

## 2.1 Electrical characteristics (curves)

**Figure 1. Safe operating area**

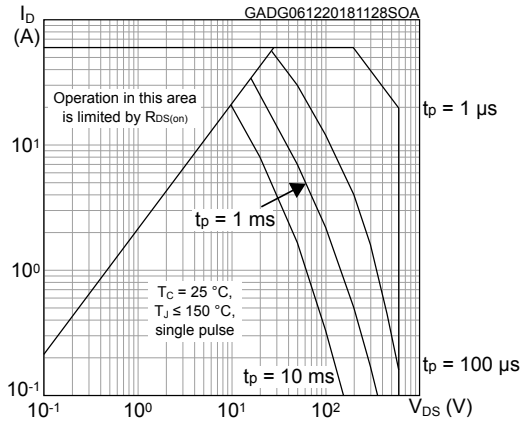

**Figure 2. Normalized thermal impedance**

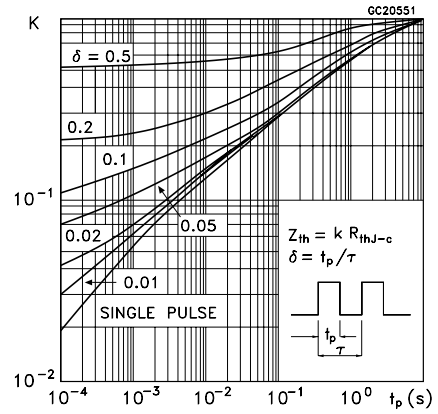

**Figure 3. Output characteristics**

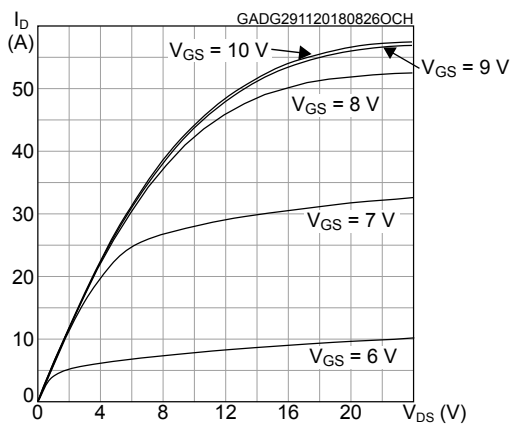

**Figure 4. Transfer characteristics**

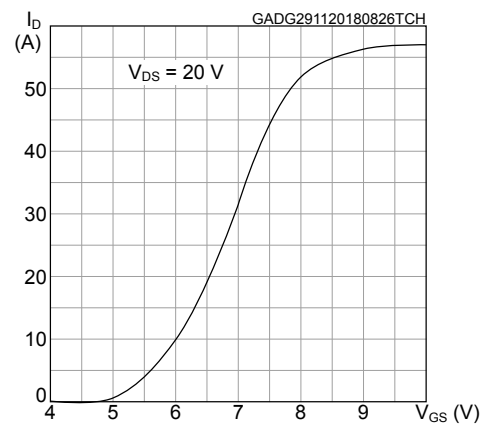

**Figure 5. Gate charge vs gate-source voltage**

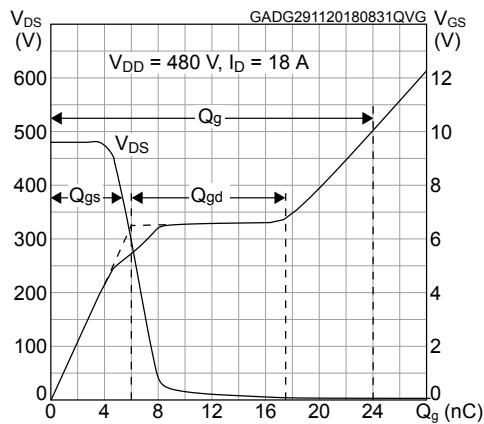

**Figure 6. Capacitance variations**

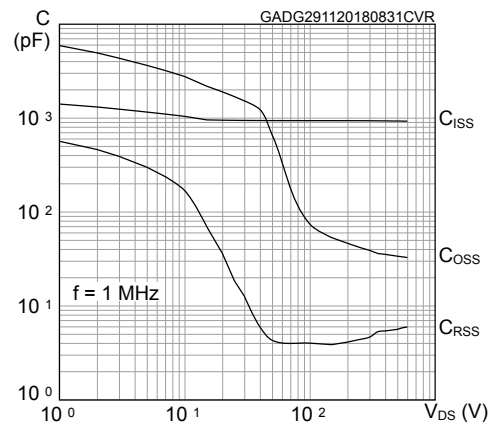

**Figure 7. Static drain-source on-resistance**

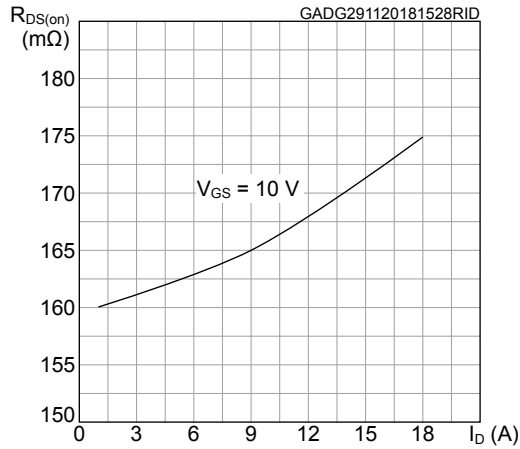

**Figure 8. Normalized on-resistance vs temperature**

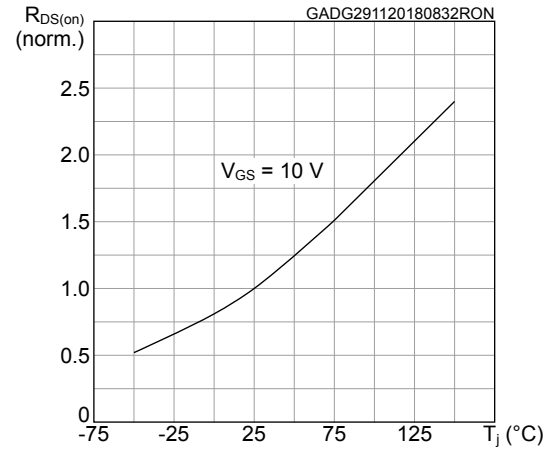

**Figure 9. Normalized gate threshold voltage vs temperature**

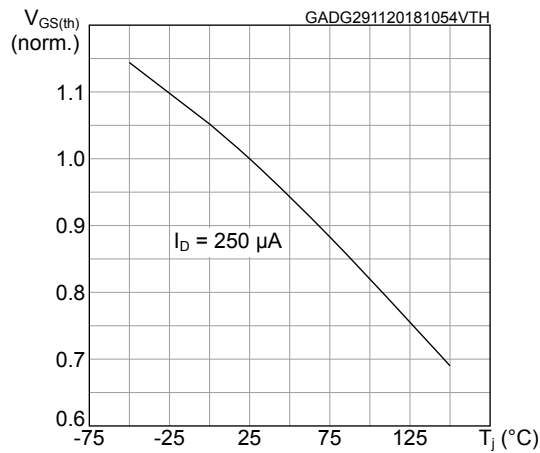

**Figure 10. Normalized  $V_{(BR)DSS}$  vs temperature**

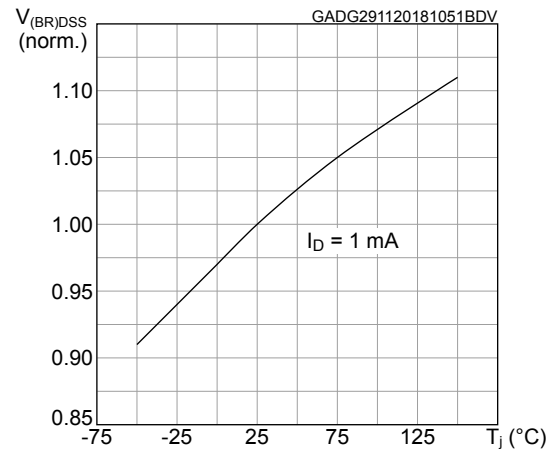

**Figure 11. Output capacitance stored energy**

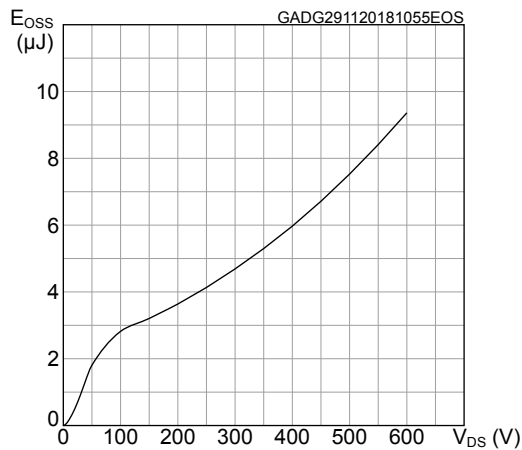

**Figure 12. Source-drain diode forward characteristics**

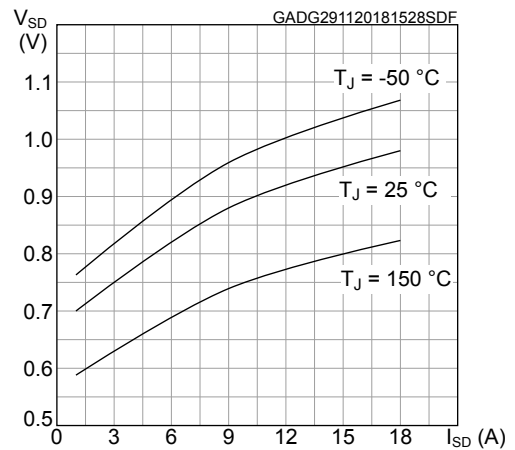

### 3 Test circuits

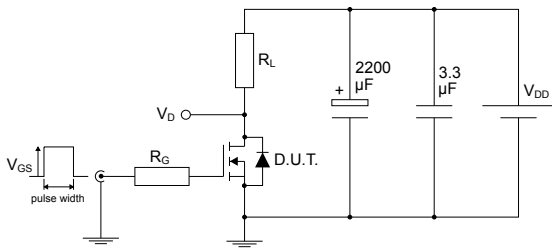
**Figure 13. Test circuit for resistive load switching times**

AM01468v1

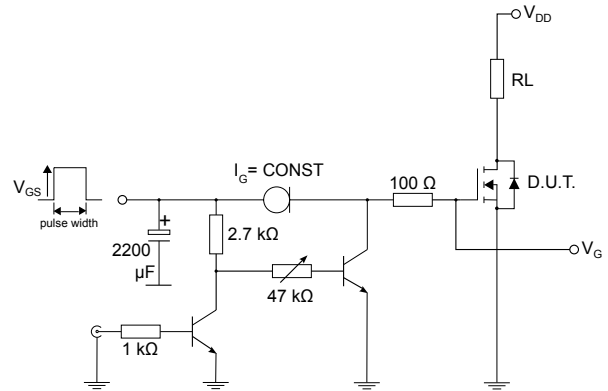
**Figure 14. Test circuit for gate charge behavior**

AM01469v10

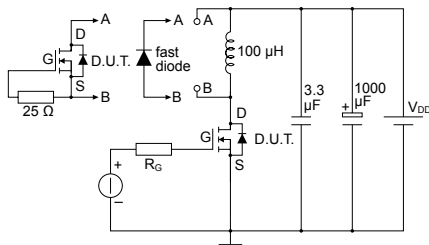
**Figure 15. Test circuit for inductive load switching and diode recovery times**

AM01470v1

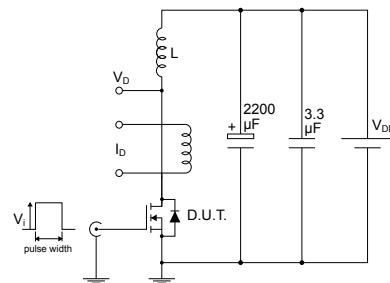
**Figure 16. Unclamped inductive load test circuit**

AM01471v1

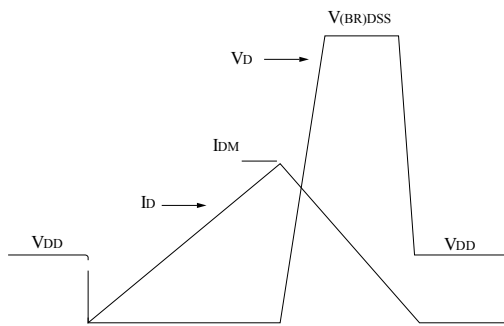
**Figure 17. Unclamped inductive waveform**

AM01472v1

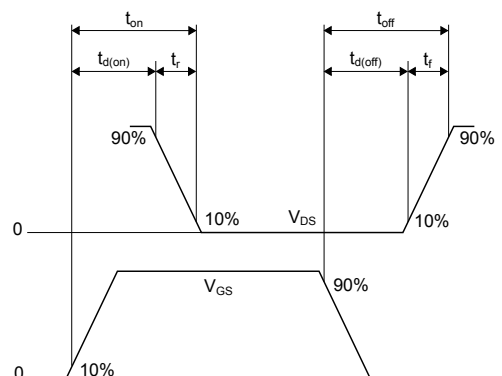
**Figure 18. Switching time waveform**

AM01473v1

## 4 Package information

In order to meet environmental requirements, ST offers these devices in different grades of **ECOPACK** packages, depending on their level of environmental compliance. ECOPACK specifications, grade definitions and product status are available at: [www.st.com](http://www.st.com). ECOPACK is an ST trademark.

### 4.1 TO-220FP package information

Figure 19. TO-220FP package outline

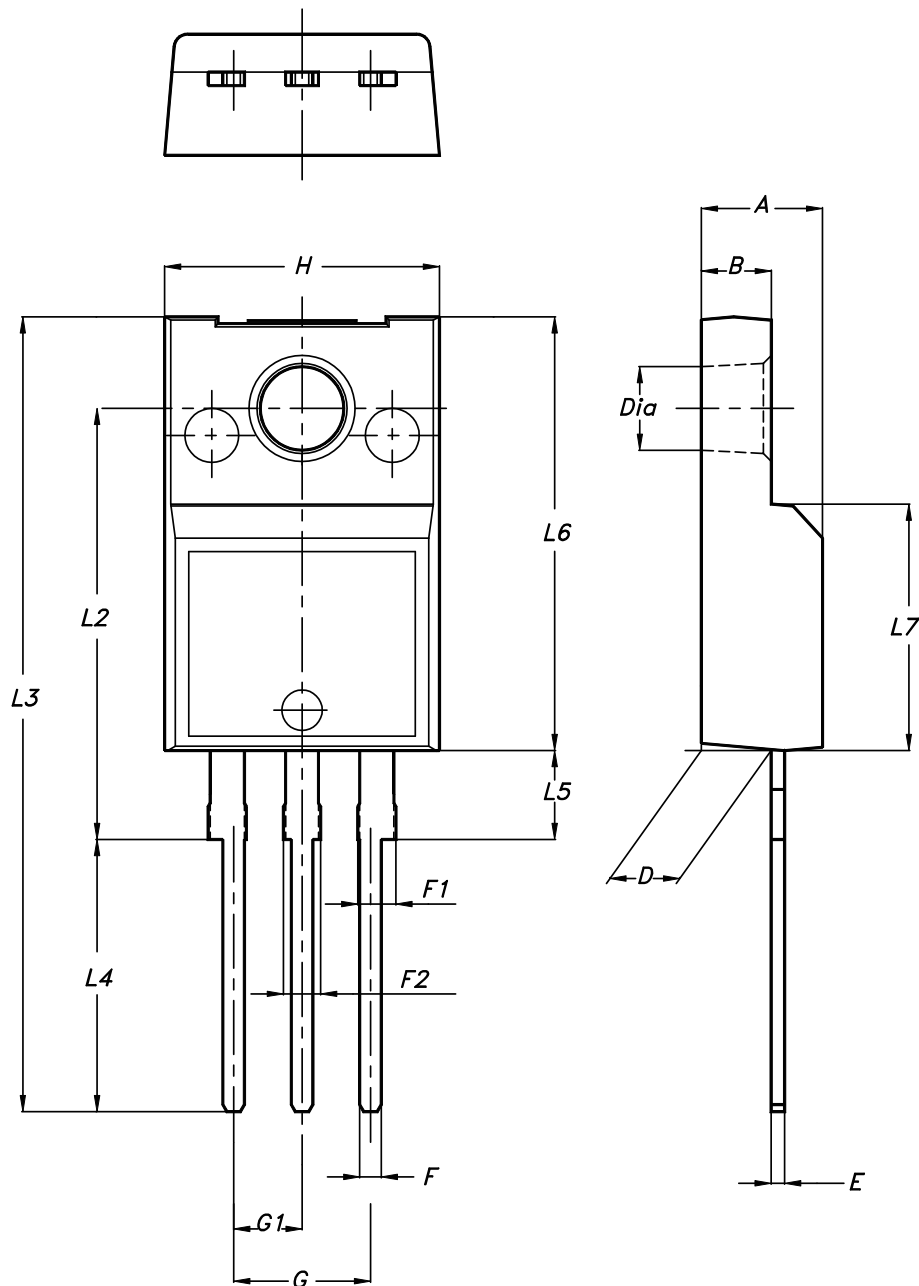

7012510\_Rev\_13\_B



**Table 8. TO-220FP package mechanical data**

Dim.	mm		
	Min.	Typ.	Max.
A	4.40		4.60
B	2.50		2.70
D	2.50		2.75
E	0.45		0.70
F	0.75		1.00
F1	1.15		1.70
F2	1.15		1.70
G	4.95		5.20
G1	2.40		2.70
H	10.00		10.40
L2		16.00	
L3	28.60		30.60
L4	9.80		10.60
L5	2.90		3.60
L6	15.90		16.40
L7	9.00		9.30
Dia	3.00		3.20

## Revision history

**Table 9. Document revision history**

Date	Version	Changes
07-Dec-2018	1	First release.
10-Sep-2020	2	Updated <a href="#">Table 1</a> .

---

## Contents

<b>1</b>	<b>Electrical ratings</b> .....	<b>2</b>
<b>2</b>	<b>Electrical characteristics</b> .....	<b>3</b>
<b>2.1</b>	<b>Electrical characteristics (curves)</b> .....	<b>5</b>
<b>3</b>	<b>Test circuits</b> .....	<b>7</b>
<b>4</b>	<b>Package information</b> .....	<b>8</b>
<b>4.1</b>	<b>TO-220FP package information</b> .....	<b>8</b>
	<b>Revision history</b> .....	<b>10</b>

**IMPORTANT NOTICE – PLEASE READ CAREFULLY**

STMicroelectronics NV and its subsidiaries (“ST”) reserve the right to make changes, corrections, enhancements, modifications, and improvements to ST products and/or to this document at any time without notice. Purchasers should obtain the latest relevant information on ST products before placing orders. ST products are sold pursuant to ST’s terms and conditions of sale in place at the time of order acknowledgement.

Purchasers are solely responsible for the choice, selection, and use of ST products and ST assumes no liability for application assistance or the design of Purchasers’ products.

No license, express or implied, to any intellectual property right is granted by ST herein.

Resale of ST products with provisions different from the information set forth herein shall void any warranty granted by ST for such product.

ST and the ST logo are trademarks of ST. For additional information about ST trademarks, please refer to [www.st.com/trademarks](http://www.st.com/trademarks). All other product or service names are the property of their respective owners.

Information in this document supersedes and replaces information previously supplied in any prior versions of this document.

© 2020 STMicroelectronics – All rights reserved

## X-ON Electronics

Largest Supplier of Electrical and Electronic Components

*Click to view similar products for [MOSFET](#) category:*

*Click to view products by [STMicroelectronics](#) manufacturer:*

Other Similar products are found below :

[614233C](#) [648584F](#) [IRFD120](#) [JANTX2N5237](#) [2N7000](#) [FCA20N60\\_F109](#) [FDZ595PZ](#) [2SK2545\(Q,T\)](#) [405094E](#) [423220D](#)  
[TPCC8103,L1Q\(CM](#) [MIC4420CM-TR](#) [VN1206L](#) [614234A](#) [715780A](#) [NTNS3166NZT5G](#) [SSM6J414TU,LF\(T](#) [751625C](#)  
[IPS70R2K0CEAKMA1](#) [BUK954R8-60E](#) [DMN3404LQ-7](#) [NTE6400](#) [SQJ402EP-T1-GE3](#) [2SK2614\(TE16L1,Q\)](#) [2N7002KW-FAI](#)  
[DMN1017UCP3-7](#) [EFC2J004NUZTDG](#) [ECH8691-TL-W](#) [FCAB21350L1](#) [P85W28HP2F-7071](#) [DMN1053UCP4-7](#) [NTE221](#) [NTE2384](#)  
[NTE2903](#) [NTE2941](#) [NTE2945](#) [NTE2946](#) [NTE2960](#) [NTE2967](#) [NTE2969](#) [NTE2976](#) [NTE455](#) [NTE6400A](#) [NTE2910](#) [NTE2916](#) [NTE2956](#)  
[NTE2911](#) [TK10A80W,S4X\(S](#) [SSM6P69NU,LF](#) [DMP22D4UFO-7B](#)