

N-channel 600 V, 0.255 Ω typ., 13 A MDmesh M2 Power MOSFET in a TO-220FP wide creepage package

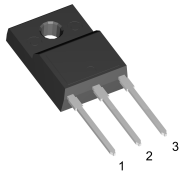

TO-220FP wide creepage

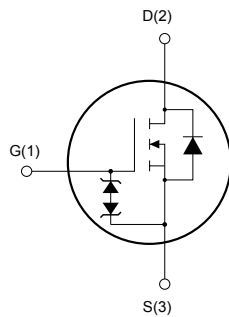

AM15572v1_no_tab



Features

| Order code | $V_{DS} @ T_{Jmax}$ | $R_{DS(on)}$ max. | I_D |
|-------------|---------------------|-------------------|-------|
| STFH18N60M2 | 650 V | 0.280 Ω | 13 A |

- Extremely low gate charge
- Excellent output capacitance (C_{OSS}) profile
- 100% avalanche tested
- Zener-protected
- Wide distance of 4.25 mm between the pins

Applications

- Switching applications
- LCC converters
- Resonant converters

Description

This device is an N-channel Power MOSFET developed using MDmesh M2 technology. Thanks to its strip layout and an improved vertical structure, the device exhibits low on-resistance and optimized switching characteristics, rendering it suitable for the most demanding high efficiency converters.

The TO-220FP wide creepage package provides increased surface insulation for Power MOSFETs to prevent failure due to arcing, which can occur in polluted environments.

Product status link

[STFH18N60M2](#)

Product summary

| | |
|-------------------|------------------------|
| Order code | STFH18N60M2 |
| Marking | 18N60M2 |
| Package | TO-220FP wide creepage |
| Packing | Tube |

1 Electrical ratings

Table 1. Absolute maximum ratings

| Symbol | Parameter | Value | Unit |
|----------------|---|------------|------------------|
| V_{GS} | Gate-source voltage | ± 25 | V |
| $I_D^{(1)}$ | Drain current (continuous) at $T_C = 25\text{ }^\circ\text{C}$ | 13 | A |
| | Drain current (continuous) at $T_C = 100\text{ }^\circ\text{C}$ | 8 | A |
| $I_{DM}^{(2)}$ | Drain current (pulsed) | 52 | A |
| P_{TOT} | Total power dissipation at $T_C = 25\text{ }^\circ\text{C}$ | 25 | W |
| $dv/dt^{(3)}$ | Peak diode recovery voltage slope | 15 | V/ns |
| $dv/dt^{(4)}$ | MOSFET dv/dt ruggedness | 50 | V/ns |
| V_{ISO} | Insulation withstand voltage (RMS) from all three leads to external heat sink ($t = 1\text{ s}$; $T_C = 25\text{ }^\circ\text{C}$) | 2.5 | kV |
| T_{stg} | Storage temperature range | -55 to 150 | $^\circ\text{C}$ |
| T_j | Operating junction temperature range | | |

- Limited by maximum junction temperature.
- Pulse width limited by safe operating area.
- $I_{SD} \leq 13\text{ A}$, $di/dt \leq 400\text{ A}/\mu\text{s}$; $V_{DS(peak)} < V_{(BR)DSS}$, $V_{DD} = 400\text{ V}$
- $V_{DS} \leq 480\text{ V}$

Table 2. Thermal data

| Symbol | Parameter | Value | Unit |
|----------------|-------------------------------------|-------|---------------------------|
| $R_{thj-case}$ | Thermal resistance junction-case | 5 | $^\circ\text{C}/\text{W}$ |
| $R_{thj-amb}$ | Thermal resistance junction-ambient | 62.5 | $^\circ\text{C}/\text{W}$ |

Table 3. Avalanche characteristics

| Symbol | Parameter | Value | Unit |
|----------|--|-------|------|
| I_{AR} | Avalanche current, repetitive or not repetitive (pulse width limited by T_{jmax}) | 3 | A |
| E_{AS} | Single pulse avalanche energy (starting $T_j = 25\text{ }^\circ\text{C}$, $I_D = I_{AR}$, $V_{DD} = 50\text{ V}$) | 135 | mJ |

2 Electrical characteristics

($T_C = 25\text{ °C}$ unless otherwise specified).

Table 4. On /off states

| Symbol | Parameter | Test conditions | Min. | Typ. | Max. | Unit |
|---------------|-----------------------------------|--|------|-------|----------|---------------|
| $V_{(BR)DSS}$ | Drain-source breakdown voltage | $I_D = 1\text{ mA}$, $V_{GS} = 0\text{ V}$ | 600 | | | V |
| I_{DSS} | Zero gate voltage drain current | $V_{GS} = 0\text{ V}$, $V_{DS} = 600\text{ V}$ | | | 1 | μA |
| | | $V_{GS} = 0\text{ V}$, $V_{DS} = 600\text{ V}$, $T_C = 125\text{ °C}$ ⁽¹⁾ | | | 100 | μA |
| I_{GSS} | Gate-body leakage current | $V_{DS} = 0\text{ V}$, $V_{GS} = \pm 25\text{ V}$ | | | ± 10 | μA |
| $V_{GS(th)}$ | Gate threshold voltage | $V_{DS} = V_{GS}$, $I_D = 250\text{ }\mu\text{A}$ | 2 | 3 | 4 | V |
| $R_{DS(on)}$ | Static drain-source on-resistance | $V_{GS} = 10\text{ V}$, $I_D = 6.5\text{ A}$ | | 0.255 | 0.280 | Ω |

1. Defined by design, not subject to production test.

Table 5. Dynamic

| Symbol | Parameter | Test conditions | Min. | Typ. | Max. | Unit |
|-------------------------------|-------------------------------|---|------|-------|------|----------|
| C_{iss} | Input capacitance | $V_{DS} = 100\text{ V}$, $f = 1\text{ MHz}$, $V_{GS} = 0\text{ V}$ | - | 791 | - | pF |
| C_{oss} | Output capacitance | | - | 40 | - | pF |
| C_{rSS} | Reverse transfer capacitance | | - | 1.3 | - | pF |
| $C_{oss\ eq.}$ ⁽¹⁾ | Equivalent output capacitance | $V_{DS} = 0$ to 480 V , $V_{GS} = 0\text{ V}$ | - | 164.5 | - | pF |
| R_G | Intrinsic gate resistance | $f = 1\text{ MHz}$, $I_D = 0\text{ A}$ | - | 5.6 | - | Ω |
| Q_g | Total gate charge | $V_{DD} = 480\text{ V}$, $I_D = 13\text{ A}$, $V_{GS} = 0$ to 10 V (see Figure 14. Test circuit for gate charge behavior) | - | 21.5 | - | nC |
| Q_{gs} | Gate-source charge | | - | 3.2 | - | nC |
| Q_{gd} | Gate-drain charge | | - | 11.3 | - | nC |

1. $C_{oss\ eq.}$ is defined as a constant equivalent capacitance giving the same charging time as C_{oss} when V_{DS} increases from 0 to 80% V_{DSS} .

Table 6. Switching times

| Symbol | Parameter | Test conditions | Min. | Typ. | Max. | Unit |
|--------------|---------------------|--|------|------|------|------|
| $t_{d(on)}$ | Turn-on delay time | $V_{DD} = 300\text{ V}$, $I_D = 6.5\text{ A}$, $R_G = 4.7\text{ }\Omega$, $V_{GS} = 10\text{ V}$ (see Figure 13. Test circuit for resistive load switching times and Figure 18. Switching time waveform) | - | 12 | - | ns |
| t_r | Rise time | | - | 9 | - | ns |
| $t_{d(off)}$ | Turn-off delay time | | - | 47 | - | ns |
| t_f | Fall time | | - | 10.6 | - | ns |

Table 7. Source drain diode

| Symbol | Parameter | Test conditions | Min. | Typ. | Max. | Unit |
|-----------------|-------------------------------|--|------|------|------|---------------|
| I_{SD} | Source-drain current | | - | | 13 | A |
| $I_{SDM}^{(1)}$ | Source-drain current (pulsed) | | - | | 52 | A |
| $V_{SD}^{(2)}$ | Forward on voltage | $I_{SD} = 13\text{ A}$, $V_{GS} = 0\text{ V}$ | - | | 1.6 | V |
| t_{rr} | Reverse recovery time | $I_{SD} = 13\text{ A}$, $di/dt = 100\text{ A}/\mu\text{s}$ | - | 305 | | ns |
| Q_{rr} | Reverse recovery charge | $V_{DD} = 60\text{ V}$ (see Figure 15. Test circuit for inductive load switching and diode recovery times) | - | 3.3 | | μC |
| I_{RRM} | Reverse recovery current | (see Figure 15. Test circuit for inductive load switching and diode recovery times) | - | 22 | | A |
| t_{rr} | Reverse recovery time | $I_{SD} = 13\text{ A}$, $di/dt = 100\text{ A}/\mu\text{s}$ | - | 417 | | ns |
| Q_{rr} | Reverse recovery charge | $V_{DD} = 60\text{ V}$, $T_j = 150\text{ }^\circ\text{C}$ | - | 4.6 | | μC |
| I_{RRM} | Reverse recovery current | (see Figure 15. Test circuit for inductive load switching and diode recovery times) | - | 22 | | A |

1. Pulse width limited by safe operating area.
2. Pulsed: pulse duration = 300 μs , duty cycle 1.5%.

2.1 Electrical characteristics (curves)

Figure 1. Safe operating area

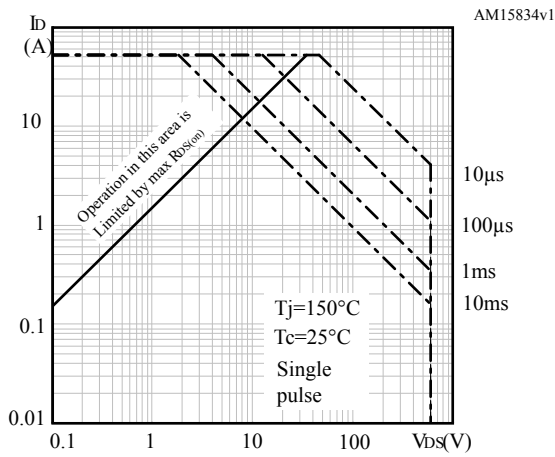

Figure 2. Thermal impedance

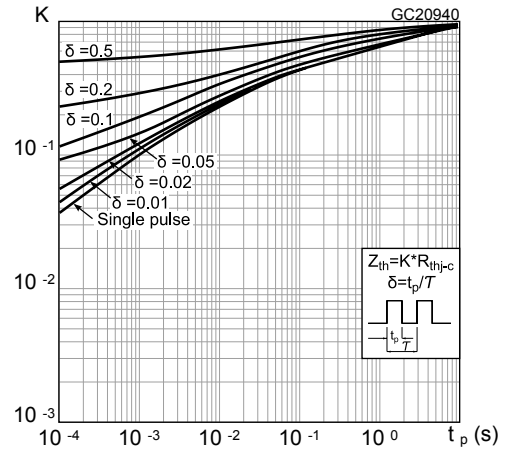

Figure 3. Output characteristics

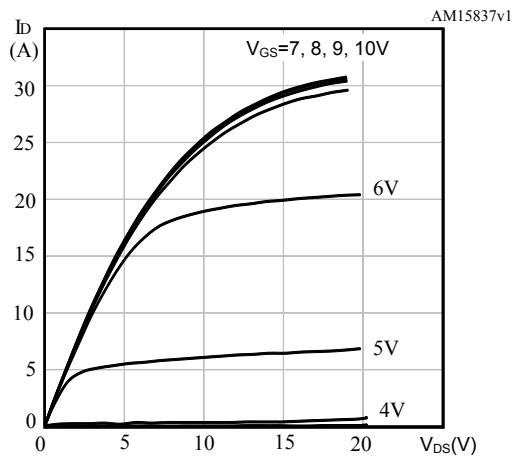

Figure 4. Transfer characteristics

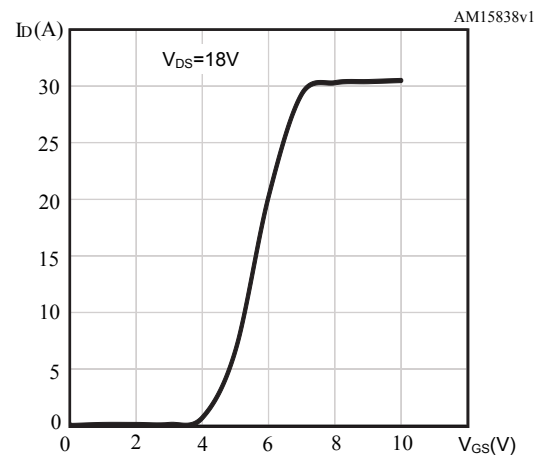

Figure 5. Gate charge vs gate-source voltage

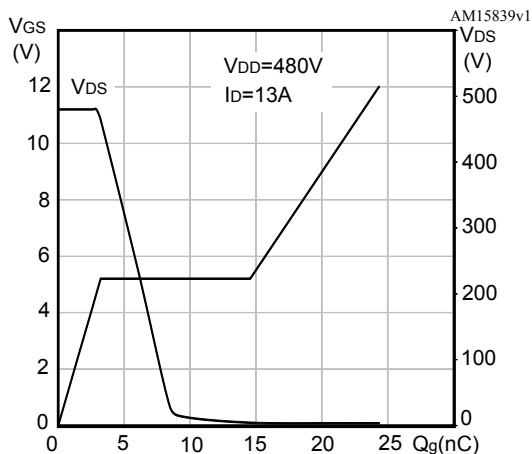

Figure 6. Static drain-source on-resistance

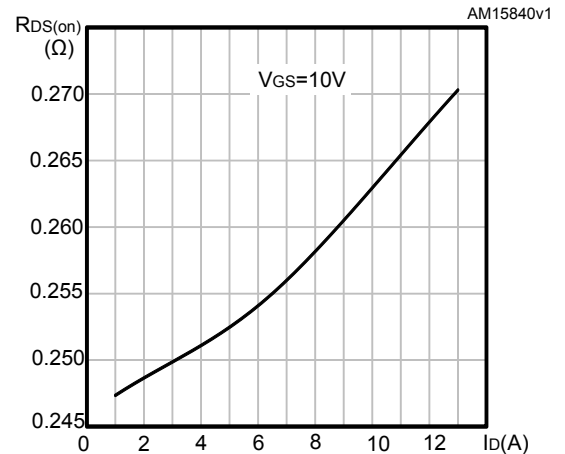

Figure 7. Capacitance variations

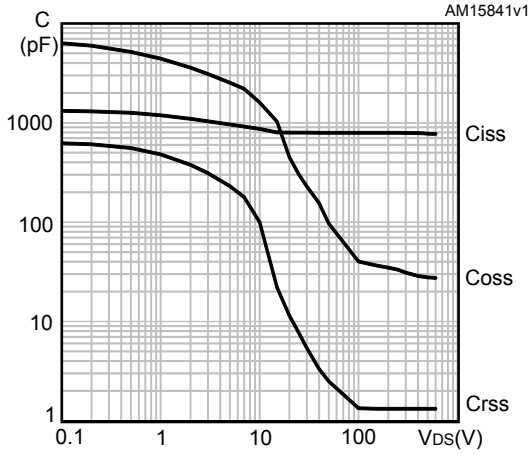

Figure 8. Normalized gate threshold voltage vs. temperature

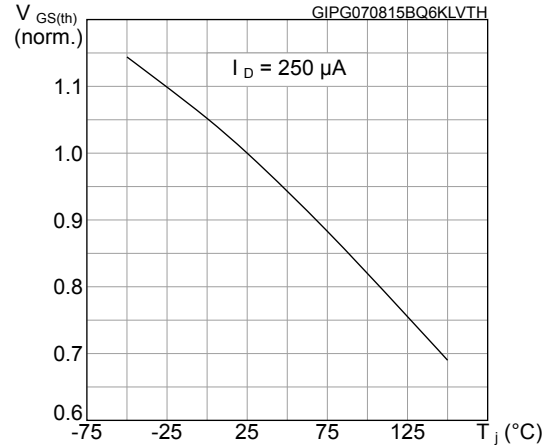

Figure 9. Normalized on-resistance vs temperature

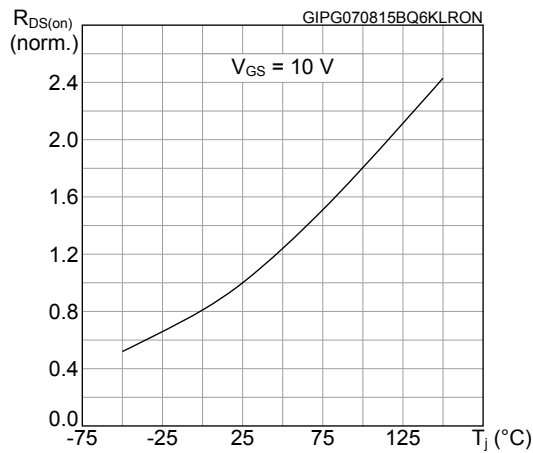

Figure 10. Source-drain diode forward characteristics

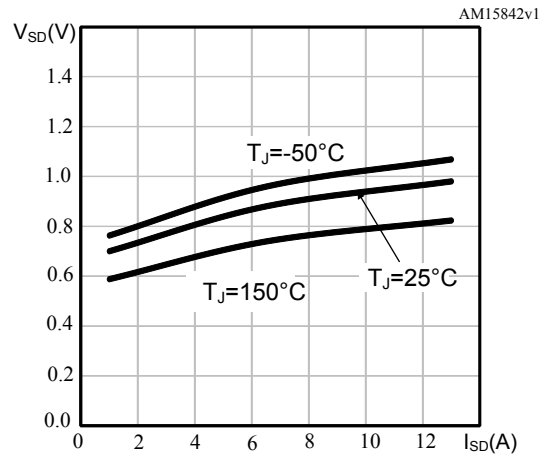

Figure 11. Normalized $V_{(BR)DSS}$ vs temperature

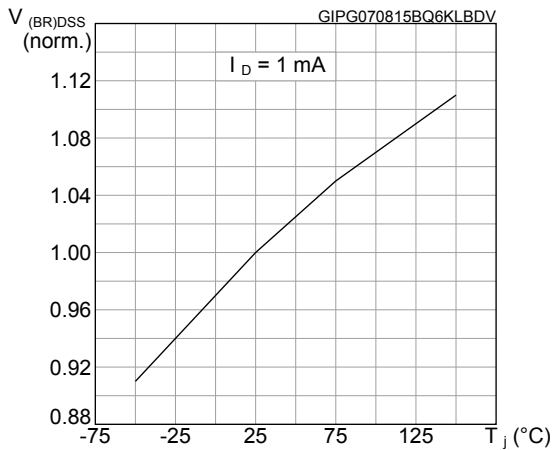
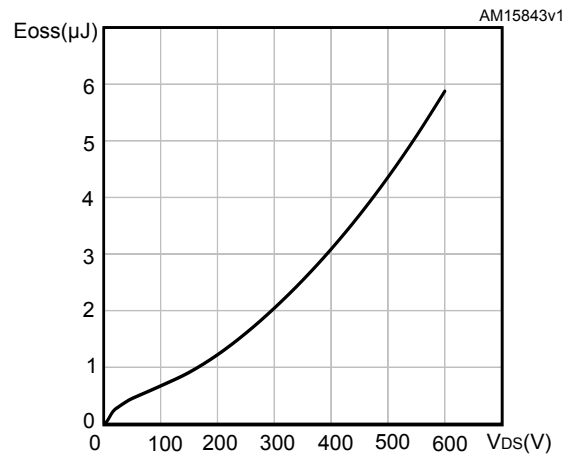
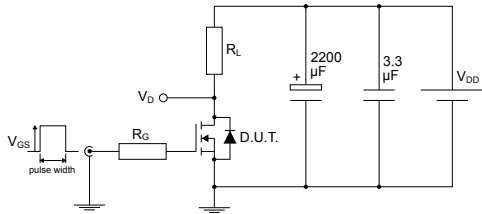

Figure 12. Output capacitance stored energy



3 Test circuits

Figure 13. Test circuit for resistive load switching times

AM01468v1

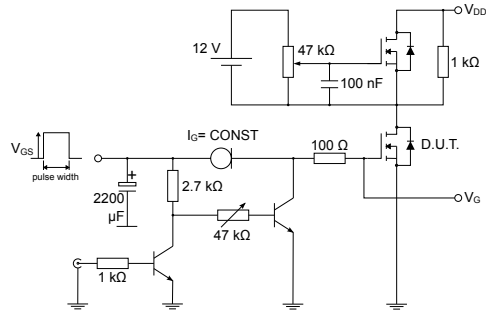
Figure 14. Test circuit for gate charge behavior

AM01469v1

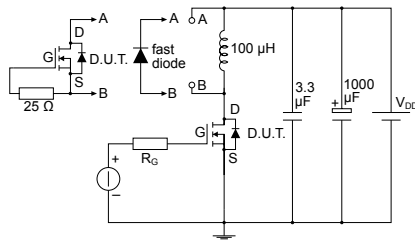
Figure 15. Test circuit for inductive load switching and diode recovery times

AM01470v1

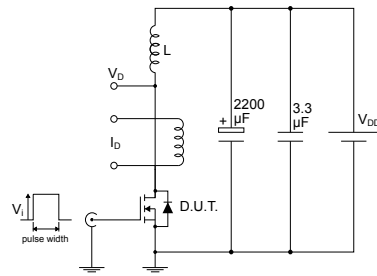
Figure 16. Unclamped inductive load test circuit

AM01471v1

Figure 17. Unclamped inductive waveform

AM01472v1

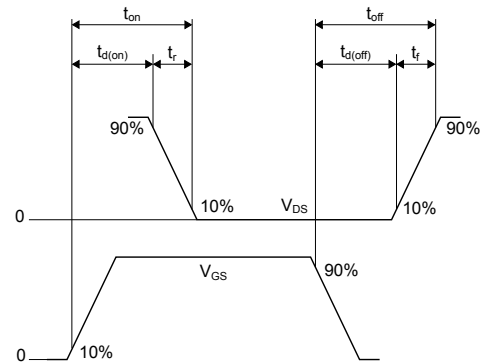
Figure 18. Switching time waveform

AM01473v1

4 Package information

In order to meet environmental requirements, ST offers these devices in different grades of **ECOPACK** packages, depending on their level of environmental compliance. ECOPACK specifications, grade definitions and product status are available at: www.st.com. ECOPACK is an ST trademark.

4.1 TO-220FP wide creepage package information

Figure 19. TO-220FP wide creepage package outline

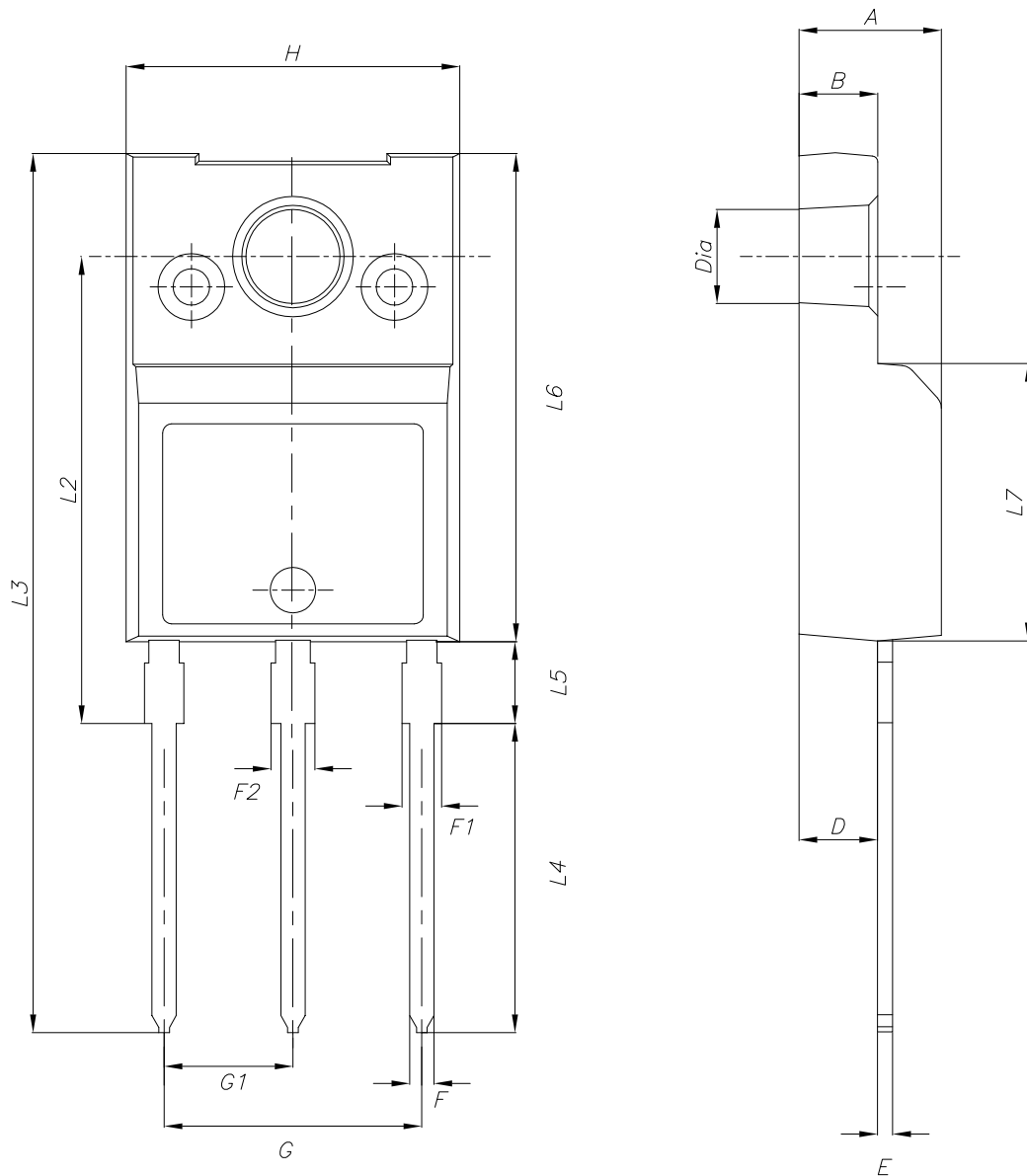

DM00260252_1

Table 8. TO-220FP wide creepage package mechanical data

| Dim. | mm | | |
|------|-------|-------|-------|
| | Min. | Typ. | Max. |
| A | 4.60 | 4.70 | 4.80 |
| B | 2.50 | 2.60 | 2.70 |
| D | 2.49 | 2.59 | 2.69 |
| E | 0.46 | | 0.59 |
| F | 0.76 | | 0.89 |
| F1 | 0.96 | | 1.25 |
| F2 | 1.11 | | 1.40 |
| G | 8.40 | 8.50 | 8.60 |
| G1 | 4.15 | 4.25 | 4.35 |
| H | 10.90 | 11.00 | 11.10 |
| L2 | 15.25 | 15.40 | 15.55 |
| L3 | 28.70 | 29.00 | 29.30 |
| L4 | 10.00 | 10.20 | 10.40 |
| L5 | 2.55 | 2.70 | 2.85 |
| L6 | 16.00 | 16.10 | 16.20 |
| L7 | 9.05 | 9.15 | 9.25 |
| Dia | 3.00 | 3.10 | 3.20 |

Revision history

Table 9. Document revision history

| Date | Revision | Changes |
|-------------|----------|--|
| 08-Jun-2016 | 1 | First release. |
| 16-Jun-2016 | 2 | Document status promoted from preliminary data to production data. Minor text changes. |
| 06-Jun-2019 | 3 | Modified Figure 8. Normalized gate threshold voltage vs. temperature, Figure 9. Normalized on-resistance vs temperature and Figure 11. Normalized $V_{(BR)DSS}$ vs temperature. Minor text changes. |

Contents

| | | |
|------------|---|-----------|
| 1 | Electrical ratings | 2 |
| 2 | Electrical characteristics | 3 |
| 2.1 | Electrical characteristics (curves) | 5 |
| 3 | Test circuits | 7 |
| 4 | Package information | 8 |
| 4.1 | TO-220FP wide creepage package information | 8 |
| | Revision history | 10 |

IMPORTANT NOTICE – PLEASE READ CAREFULLY

STMicroelectronics NV and its subsidiaries (“ST”) reserve the right to make changes, corrections, enhancements, modifications, and improvements to ST products and/or to this document at any time without notice. Purchasers should obtain the latest relevant information on ST products before placing orders. ST products are sold pursuant to ST’s terms and conditions of sale in place at the time of order acknowledgement.

Purchasers are solely responsible for the choice, selection, and use of ST products and ST assumes no liability for application assistance or the design of Purchasers’ products.

No license, express or implied, to any intellectual property right is granted by ST herein.

Resale of ST products with provisions different from the information set forth herein shall void any warranty granted by ST for such product.

ST and the ST logo are trademarks of ST. For additional information about ST trademarks, please refer to www.st.com/trademarks. All other product or service names are the property of their respective owners.

Information in this document supersedes and replaces information previously supplied in any prior versions of this document.

© 2019 STMicroelectronics – All rights reserved

X-ON Electronics

Largest Supplier of Electrical and Electronic Components

Click to view similar products for [MOSFET](#) category:

Click to view products by [STMicroelectronics](#) manufacturer:

Other Similar products are found below :

[614233C](#) [648584F](#) [IRFD120](#) [JANTX2N5237](#) [2N7000](#) [FCA20N60_F109](#) [FDZ595PZ](#) [2SK2545\(Q,T\)](#) [405094E](#) [423220D](#)
[TPCC8103,L1Q\(CM](#) [MIC4420CM-TR](#) [VN1206L](#) [614234A](#) [715780A](#) [NTNS3166NZT5G](#) [SSM6J414TU,LF\(T](#) [751625C](#)
[IPS70R2K0CEAKMA1](#) [BUK954R8-60E](#) [DMN3404LQ-7](#) [NTE6400](#) [SQJ402EP-T1-GE3](#) [2SK2614\(TE16L1,Q\)](#) [2N7002KW-FAI](#)
[DMN1017UCP3-7](#) [EFC2J004NUZTDG](#) [ECH8691-TL-W](#) [FCAB21350L1](#) [P85W28HP2F-7071](#) [DMN1053UCP4-7](#) [NTE221](#) [NTE2384](#)
[NTE2903](#) [NTE2941](#) [NTE2945](#) [NTE2946](#) [NTE2960](#) [NTE2967](#) [NTE2969](#) [NTE2976](#) [NTE455](#) [NTE6400A](#) [NTE2910](#) [NTE2916](#) [NTE2956](#)
[NTE2911](#) [TK10A80W,S4X\(S](#) [SSM6P69NU,LF](#) [DMP22D4UFO-7B](#)