

## N-channel 600 V, 0.168 $\Omega$ typ., 17 A MDmesh™ II Power MOSFET in a I<sup>2</sup>PAKFP package

Datasheet – production data

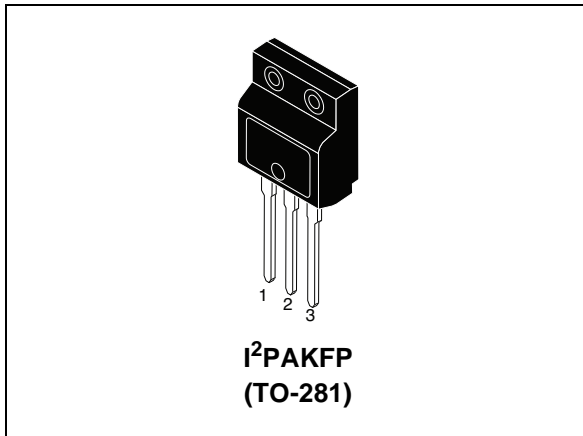
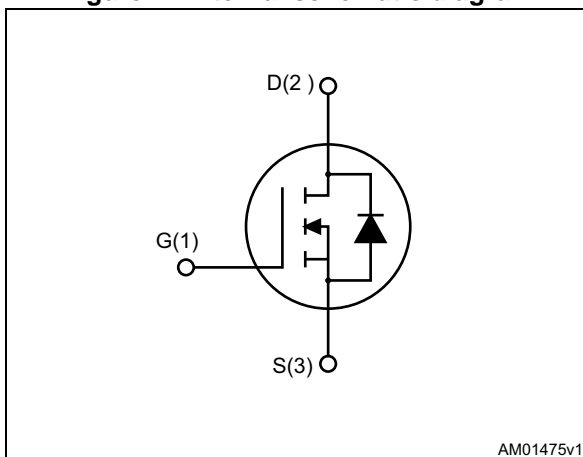

Figure 1. Internal schematic diagram



### Features

Order codes	V <sub>DS</sub> @T <sub>jmax</sub>	R <sub>DS(on)</sub> max.	I <sub>D</sub>
STFI24NM60N	650 V	0.19 $\Omega$	17 A

- Fully insulated and low profile package with increased creepage path from pin to heatsink plate
- 100% avalanche tested
- Low input capacitance and gate charge
- Low gate input resistance

### Applications

- Switching applications

### Description

This device is an N-channel Power MOSFET developed using the second generation of MDmesh™ technology. This revolutionary Power MOSFET associates a vertical structure to the company's strip layout to yield one of the world's lowest on-resistance and gate charge. It is therefore suitable for the most demanding high efficiency converters.

Table 1. Device summary

Order code	Marking	Packages	Packaging
STFI24NM60N	24NM60N	I <sup>2</sup> PAKFP (TO-281)	Tube

## Contents

<b>1</b>	<b>Electrical ratings</b> .....	<b>3</b>
<b>2</b>	<b>Electrical characteristics</b> .....	<b>4</b>
	2.1 Electrical characteristics (curves) .....	6
<b>3</b>	<b>Test circuits</b> .....	<b>8</b>
<b>4</b>	<b>Package mechanical data</b> .....	<b>9</b>
<b>5</b>	<b>Revision history</b> .....	<b>11</b>

# 1 Electrical ratings

**Table 2. Absolute maximum ratings**

Symbol	Parameter	Value	Unit
$V_{GS}$	Gate- source voltage	$\pm 30$	V
$I_D$	Drain current (continuous) at $T_C = 25\text{ °C}$	17 <sup>(1)</sup>	A
$I_D$	Drain current (continuous) at $T_C = 100\text{ °C}$	11 <sup>(1)</sup>	A
$I_{DM}^{(2)}$	Drain current (pulsed)	68 <sup>(1)</sup>	A
$P_{TOT}$	Total dissipation at $T_C = 25\text{ °C}$	30	W
$dv/dt^{(3)}$	Peak diode recovery voltage slope	15	V/ns
$V_{ISO}$	Insulation withstand voltage (RMS) from all three leads to external heat sink ( $t=1\text{ s}$ ; $T_C=25\text{ °C}$ )	2500	V
$T_J$ $T_{stg}$	Operating junction temperature Storage temperature	-55 to 150	°C

- Limited by maximum junction temperature.
- Pulse width limited by safe operating area.
- $I_{SD} \leq 17\text{ A}$ ,  $di/dt \leq 400\text{ A}/\mu\text{s}$ , peak  $V_{DS} \leq V_{(BR)DSS}$ ,  $V_{DD} = 80\% V_{(BR)DSS}$

**Table 3. Thermal data**

Symbol	Parameter	Value	Unit
$R_{thj-case}$	Thermal resistance junction-case max.	4.17	°C/W
$R_{thj-amb}$	Thermal resistance junction-ambient max.	62.5	°C/W

**Table 4. Avalanche characteristics**

Symbol	Parameter	Value	Unit
$I_{AR}$	Avalanche current, repetitive or not-repetitive (pulse width limited by $T_J$ max)	6	A
$E_{AS}$	Single pulse avalanche energy (starting $T_J = 25\text{ °C}$ , $I_D = I_{AR}$ , $V_{DD} = 50\text{ V}$ )	300	mJ

## 2 Electrical characteristics

(T<sub>case</sub> = 25 °C unless otherwise specified)

**Table 5. On /off states**

Symbol	Parameter	Test conditions	Min.	Typ.	Max.	Unit
V <sub>(BR)DSS</sub>	Drain-source breakdown voltage	V <sub>GS</sub> = 0, I <sub>D</sub> = 1 mA	600			V
I <sub>DSS</sub>	Zero gate voltage drain current	V <sub>GS</sub> = 0, V <sub>DS</sub> = 600 V			1	μA
		V <sub>GS</sub> = 0, V <sub>DS</sub> = 600 V, T <sub>C</sub> = 125 °C			100	μA
I <sub>GSS</sub>	Gate-body leakage current	V <sub>DS</sub> = 0, V <sub>GS</sub> = ± 25 V			±100	nA
V <sub>GS(th)</sub>	Gate threshold voltage	V <sub>DS</sub> = V <sub>GS</sub> , I <sub>D</sub> = 250 μA	2	3	4	V
R <sub>DS(on)</sub>	Static drain-source on- resistance	V <sub>GS</sub> = 10 V, I <sub>D</sub> = 8 A		0.168	0.19	Ω

**Table 6. Dynamic**

Symbol	Parameter	Test conditions	Min.	Typ.	Max.	Unit
C <sub>iss</sub>	Input capacitance	V <sub>DS</sub> = 50 V, f = 1 MHz, V <sub>GS</sub> = 0	-	1330	-	pF
C <sub>oss</sub>	Output capacitance		-	80	-	pF
C <sub>rss</sub>	Reverse transfer capacitance		-	3.2	-	pF
C <sub>oss eq.</sub> <sup>(1)</sup>	Equivalent output capacitance	V <sub>DS</sub> = 0 to 480 V, V <sub>GS</sub> = 0	-	182	-	pF
R <sub>g</sub>	Gate input resistance	f = 1 MHz open drain	-	5	-	Ω
Q <sub>g</sub>	Total gate charge	V <sub>DD</sub> = 480 V, I <sub>D</sub> = 17 A, V <sub>GS</sub> = 10 V (see Figure 15)	-	44	-	nC
Q <sub>gs</sub>	Gate-source charge		-	7	-	nC
Q <sub>gd</sub>	Gate-drain charge		-	24	-	nC

1. C<sub>o(eff)</sub> is defined as a constant equivalent capacitance giving the same charging time as C<sub>oss</sub> when V<sub>DS</sub> increases from 0 to 80% V<sub>DS</sub>.

Table 7. Switching times

Symbol	Parameter	Test conditions	Min.	Typ.	Max	Unit
$t_{d(on)}$	Turn-on delay time	$V_{DD} = 300\text{ V}$ , $I_D = 8.5\text{ A}$ , $R_G = 4.7\ \Omega$ , $V_{GS} = 10\text{ V}$ (see Figure 14)	-	11.5	-	ns
$t_{r(v)}$	Voltage rise time		-	16.5	-	ns
$t_{d(off)}$	Turn-off-delay time		-	73	-	ns
$t_{f(i)}$	Fall time		-	37	-	ns

Table 8. Source drain diode

Symbol	Parameter	Test conditions	Min.	Typ.	Max	Unit
$I_{SD}$	Source-drain current		-		17	A
$I_{SDM}^{(1)}$	Source-drain current (pulsed)		-		68	A
$V_{SD}^{(2)}$	Forward on voltage	$I_{SD} = 17\text{ A}$ , $V_{GS} = 0$	-		1.6	V
$t_{rr}$	Reverse recovery time	$I_{SD} = 17\text{ A}$ , $di/dt = 100\text{ A}/\mu\text{s}$ $V_{DD} = 60\text{ V}$ (see Figure 16)	-	340		ns
$Q_{rr}$	Reverse recovery charge		-	4.6		$\mu\text{C}$
$I_{RRM}$	Reverse recovery current		-	27		A
$t_{rr}$	Reverse recovery time	$I_{SD} = 17\text{ A}$ , $di/dt = 100\text{ A}/\mu\text{s}$ $V_{DD} = 60\text{ V}$ , $T_J = 150\text{ }^\circ\text{C}$ (see Figure 16)	-	404		ns
$Q_{rr}$	Reverse recovery charge		-	5.7		$\mu\text{C}$
$I_{RRM}$	Reverse recovery current		-	28		A

1. Pulse width limited by safe operating area
2. Pulsed: pulse duration = 300  $\mu\text{s}$ , duty cycle 1.5%

## 2.1 Electrical characteristics (curves)

Figure 2. Safe operating area

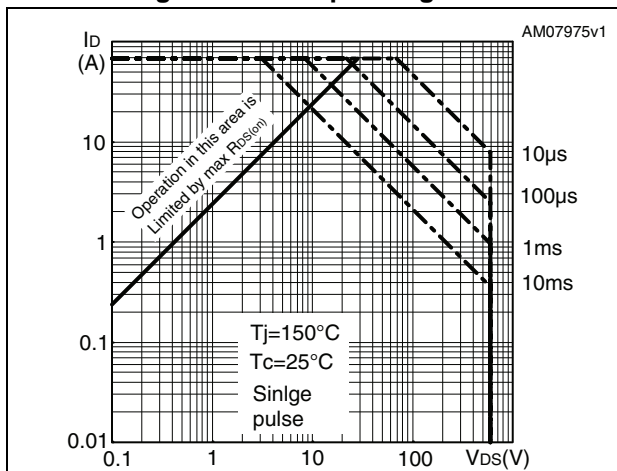

Figure 3. Thermal impedance

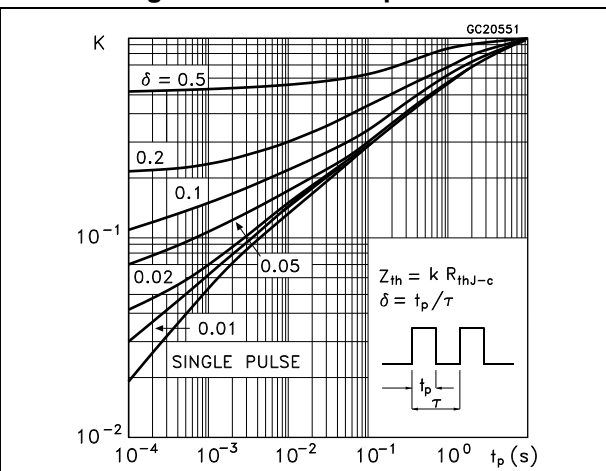

Figure 4. Output characteristics

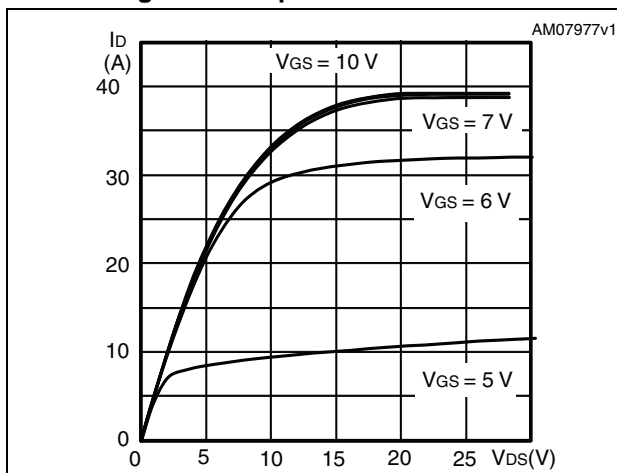

Figure 5. Transfer characteristics

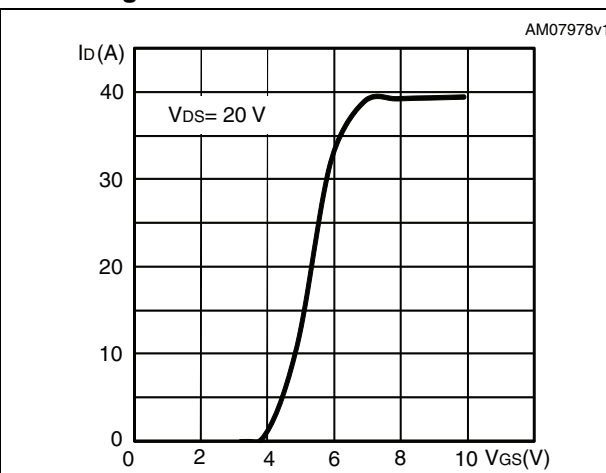

Figure 6. Gate charge vs gate-source voltage

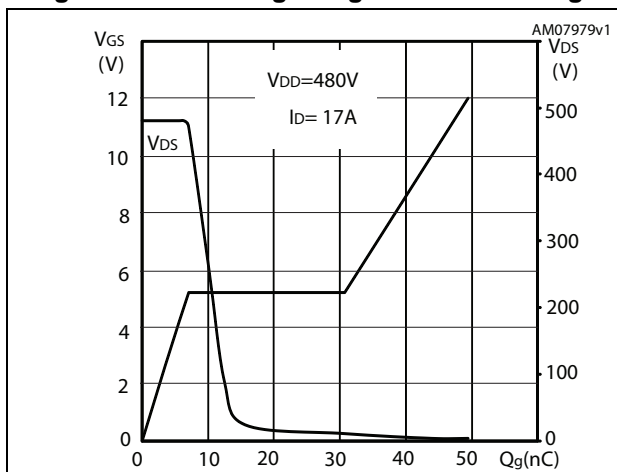

Figure 7. Static drain-source on-resistance

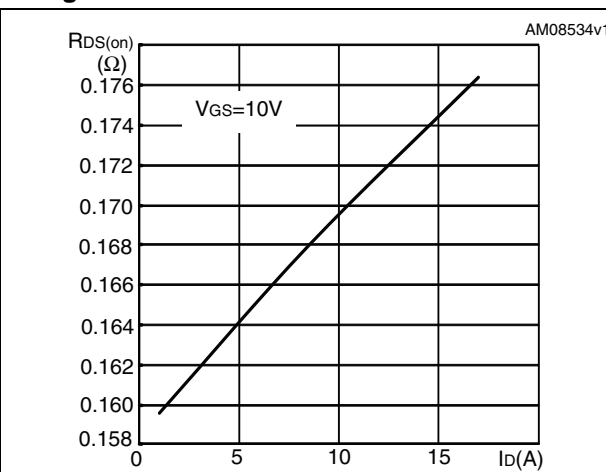

Figure 8. Capacitance variations

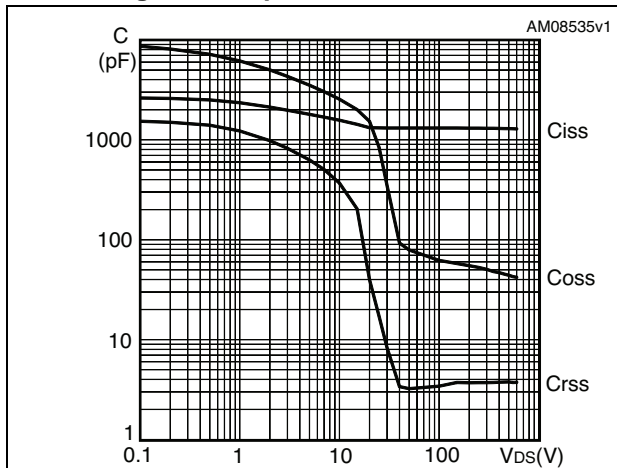

Figure 9. Output capacitance stored energy

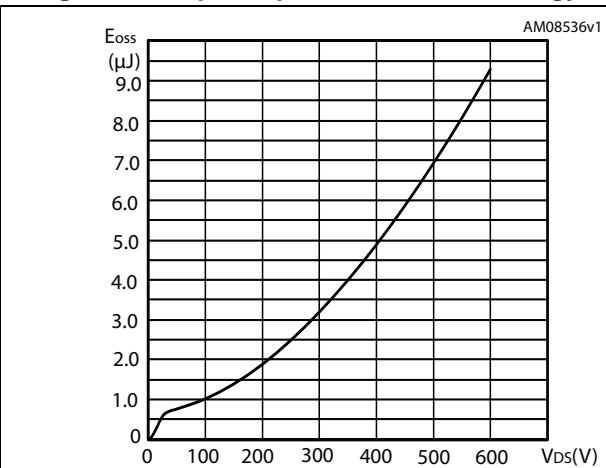

Figure 10. Normalized gate threshold voltage vs temperature

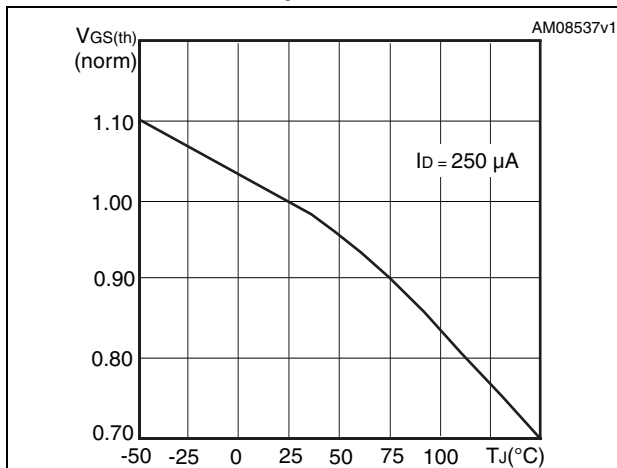

Figure 11. Normalized on-resistance vs temperature

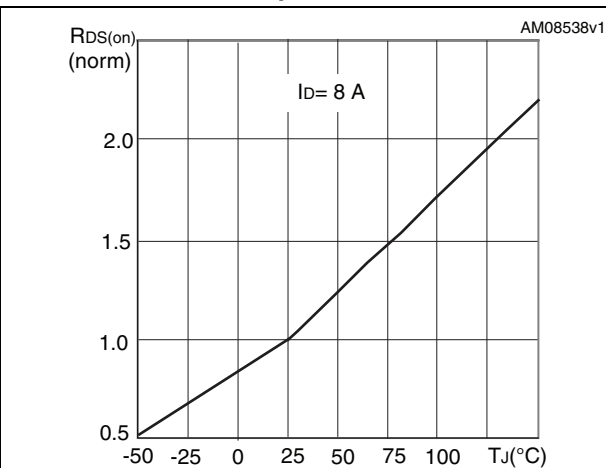

Figure 12. Normalized V(BR)DSS vs temperature

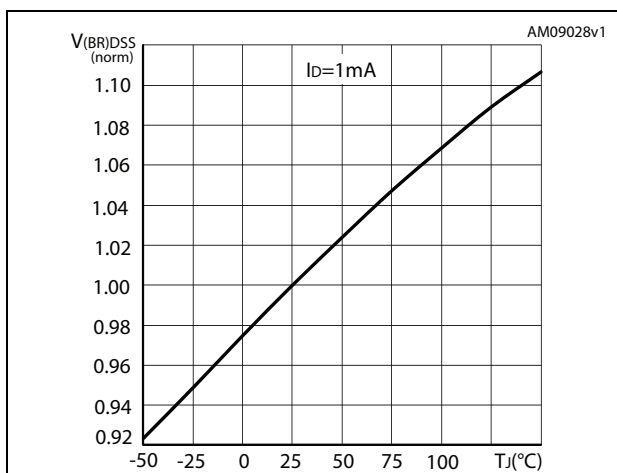
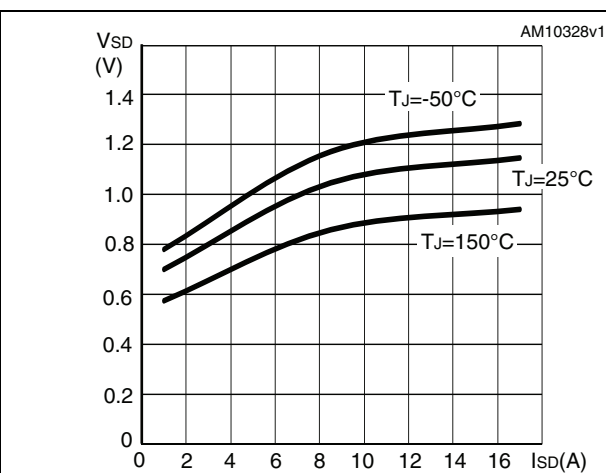

Figure 13. Source-drain diode forward characteristics



### 3 Test circuits

Figure 14. Switching times test circuit for resistive load



Figure 15. Gate charge test circuit



Figure 16. Test circuit for inductive load switching and diode recovery times



Figure 17. Unclamped inductive load test circuit



Figure 18. Unclamped inductive waveform

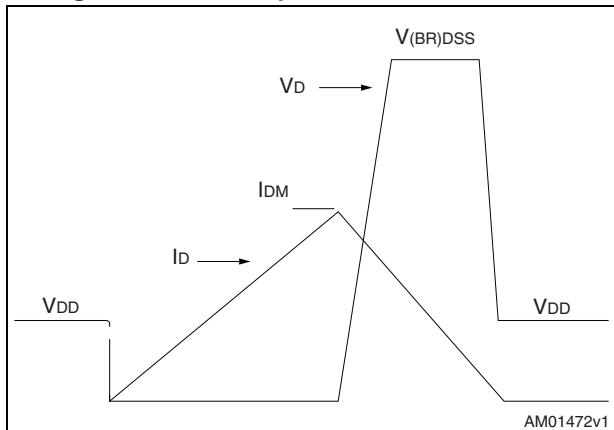
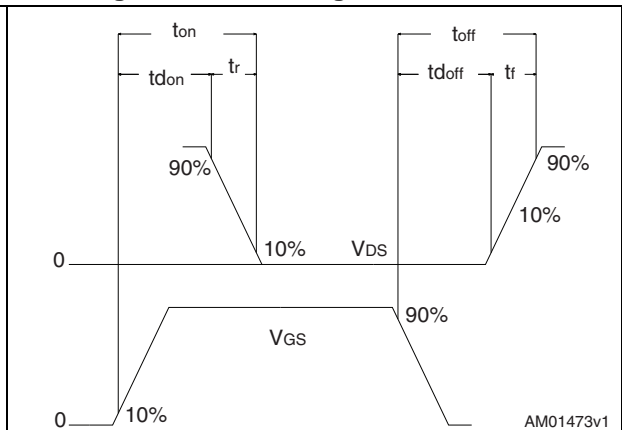

Figure 19. Switching time waveform





## 4 Package mechanical data

In order to meet environmental requirements, ST offers these devices in different grades of ECOPACK<sup>®</sup> packages, depending on their level of environmental compliance. ECOPACK<sup>®</sup> specifications, grade definitions and product status are available at: [www.st.com](http://www.st.com). ECOPACK<sup>®</sup> is an ST trademark.

Figure 20. I<sup>2</sup>PAKFP (TO-281) drawing

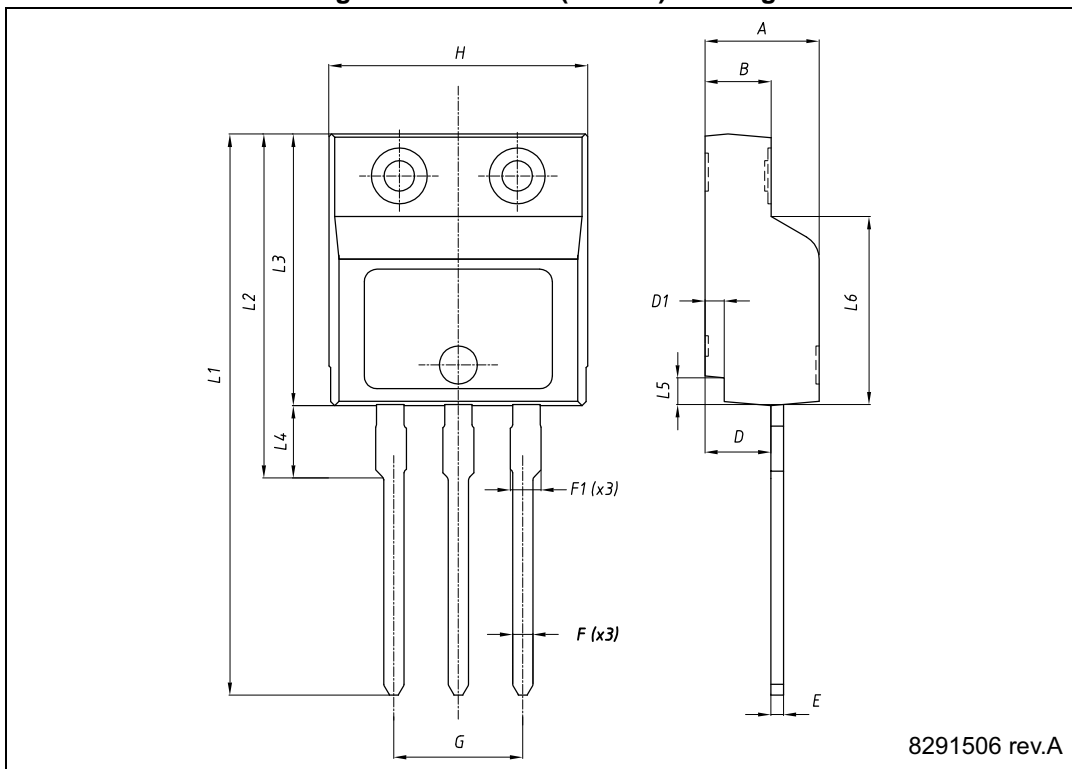

Table 9. I<sup>2</sup>PAKFP (TO-281) mechanical data

Dim.	mm		
	Min.	Typ.	Max.
A	4.40		4.60
B	2.50		2.70
D	2.50		2.75
D1	0.65		0.85
E	0.45		0.70
F	0.75		1.00
F1			1.20
G	4.95	-	5.20
H	10.00		10.40
L1	21.00		23.00
L2	13.20		14.10
L3	10.55		10.85
L4	2.70		3.20
L5	0.85		1.25
L6	7.30		7.50

## 5 Revision history

**Table 10. Document revision history**

Date	Revision	Changes
07-Nov-2011	1	First release.
20-Mar-2012	2	<ul style="list-style-type: none"><li>– Document status promoted from preliminary data to production data.</li><li>– Package name has been updated.</li><li>– Minor text changes.</li></ul>
24-Jul-2014	3	<ul style="list-style-type: none"><li>– Modified: the entire typical values in <a href="#">Table 6</a></li><li>– Minor text changes</li></ul>

**IMPORTANT NOTICE – PLEASE READ CAREFULLY**

STMicroelectronics NV and its subsidiaries ("ST") reserve the right to make changes, corrections, enhancements, modifications, and improvements to ST products and/or to this document at any time without notice. Purchasers should obtain the latest relevant information on ST products before placing orders. ST products are sold pursuant to ST's terms and conditions of sale in place at the time of order acknowledgement.

Purchasers are solely responsible for the choice, selection, and use of ST products and ST assumes no liability for application assistance or the design of Purchasers' products.

No license, express or implied, to any intellectual property right is granted by ST herein.

Resale of ST products with provisions different from the information set forth herein shall void any warranty granted by ST for such product.

ST and the ST logo are trademarks of ST. All other product or service names are the property of their respective owners.

Information in this document supersedes and replaces information previously supplied in any prior versions of this document.

© 2014 STMicroelectronics – All rights reserved

## X-ON Electronics

Largest Supplier of Electrical and Electronic Components

*Click to view similar products for [MOSFET](#) category:*

*Click to view products by [STMicroelectronics](#) manufacturer:*

Other Similar products are found below :

[614233C](#) [648584F](#) [IRFD120](#) [JANTX2N5237](#) [FCA20N60\\_F109](#) [FDZ595PZ](#) [2SK2545\(Q,T\)](#) [405094E](#) [423220D](#) [TPCC8103,L1Q\(CM](#)  
[MIC4420CM-TR](#) [VN1206L](#) [SBVS138LT1G](#) [614234A](#) [715780A](#) [NTNS3166NZT5G](#) [SSM6J414TU,LF\(T](#) [751625C](#) [BUK954R8-60E](#)  
[NTE6400](#) [SQJ402EP-T1-GE3](#) [2SK2614\(TE16L1,Q\)](#) [2N7002KW-FAI](#) [DMN1017UCP3-7](#) [EFC2J004NUZTDG](#) [ECH8691-TL-W](#)  
[FCAB21350L1](#) [P85W28HP2F-7071](#) [DMN1053UCP4-7](#) [NTE221](#) [NTE2384](#) [NTE2903](#) [NTE2941](#) [NTE2945](#) [NTE2946](#) [NTE2960](#) [NTE2967](#)  
[NTE2969](#) [NTE2976](#) [NTE455](#) [NTE6400A](#) [NTE2910](#) [NTE2916](#) [NTE2956](#) [NTE2911](#) [DMN2080UCB4-7](#) [TK10A80W,S4X\(S](#)  
[SSM6P69NU,LF](#) [DMP22D4UFO-7B](#) [DMN1006UCA6-7](#)