

Trench gate field-stop IGBT, M series 650 V, 30 A low-loss in a D²PAK package

Datasheet - production data

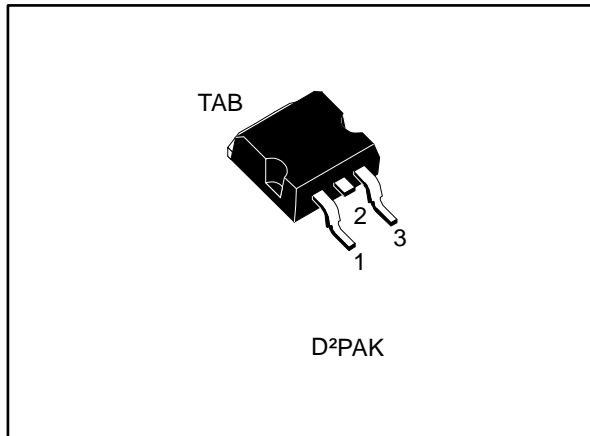
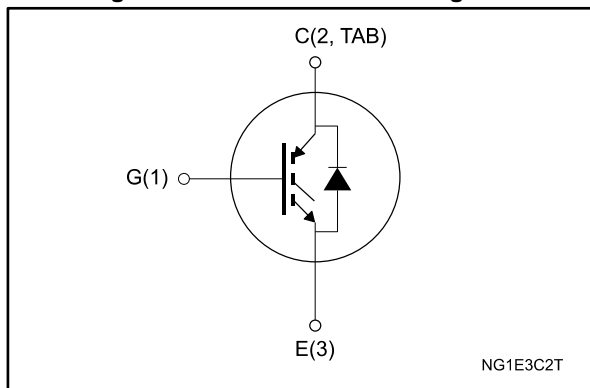

Figure 1: Internal schematic diagram



Features

- 6 μ s of short-circuit withstand time
- $V_{CE(sat)} = 1.55$ V (typ.) @ $I_c = 30$ A
- Tight parameters distribution
- Safer paralleling
- Low thermal resistance
- Soft and very fast recovery antiparallel diode

Applications

- Motor control
- UPS
- PFC

Description

This device is an IGBT developed using an advanced proprietary trench gate field-stop structure. The device is part of the M series IGBTs, which represent an optimal balance between inverter system performance and efficiency where low-loss and short-circuit functionality are essential. Furthermore, the positive $V_{CE(sat)}$ temperature coefficient and tight parameter distribution result in safer paralleling operation.

Table 1: Device summary

Order code	Marking	Package	Packaging
STGB30M65DF2	G30M65DF2	D ² PAK	Tape and reel

Contents

1	Electrical ratings	3
2	Electrical characteristics	4
	2.1 Electrical characteristics (curves)	6
3	Test circuits	11
4	Package information	12
	4.1 D ² PAK (TO-263) type A package information	12
	4.2 D ² PAK (TO-263) type A packing information	15
5	Revision history	17

1 Electrical ratings

Table 2: Absolute maximum ratings

Symbol	Parameter	Value	Unit
V _{CEs}	Collector-emitter voltage (V _{GE} = 0 V)	650	V
I _C	Continuous collector current at T _C = 25 °C	60	A
I _C	Continuous collector current at T _C = 100 °C	30	A
I _{CP} ⁽¹⁾	Pulsed collector current	120	A
V _{GE}	Gate-emitter voltage	±20	V
I _F	Continuous forward current at T _C = 25 °C	60	A
I _F	Continuous forward current at T _C = 100 °C	30	A
I _{FP} ⁽¹⁾	Pulsed forward current	120	A
P _{TOT}	Total dissipation at T _C = 25 °C	258	W
T _{STG}	Storage temperature range	-55 to 150	°C
T _J	Operating junction temperature range	-55 to 175	°C

Notes:

⁽¹⁾Pulse width limited by maximum junction temperature.

Table 3: Thermal data

Symbol	Parameter	Value	Unit
R _{thJC}	Thermal resistance junction-case IGBT	0.58	°C/W
R _{thJC}	Thermal resistance junction-case diode	1.47	°C/W
R _{thJA}	Thermal resistance junction-ambient	62.5	°C/W

2 Electrical characteristics

$T_C = 25\text{ °C}$ unless otherwise specified

Table 4: Static characteristics

Symbol	Parameter	Test conditions	Min.	Typ.	Max.	Unit
$V_{(BR)CES}$	Collector-emitter breakdown voltage	$V_{GE} = 0\text{ V}$, $I_C = 250\text{ }\mu\text{A}$	650			V
$V_{CE(sat)}$	Collector-emitter saturation voltage	$V_{GE} = 15\text{ V}$, $I_C = 30\text{ A}$		1.55	2.0	V
		$V_{GE} = 15\text{ V}$, $I_C = 30\text{ A}$, $T_J = 125\text{ °C}$		1.95		
		$V_{GE} = 15\text{ V}$, $I_C = 30\text{ A}$, $T_J = 175\text{ °C}$		2.1		
V_F	Forward on-voltage	$I_F = 30\text{ A}$		1.85	2.65	V
		$I_F = 30\text{ A}$, $T_J = 125\text{ °C}$		1.6		
		$I_F = 30\text{ A}$, $T_J = 175\text{ °C}$		1.5		
$V_{GE(th)}$	Gate threshold voltage	$V_{CE} = V_{GE}$, $I_C = 500\text{ }\mu\text{A}$	5	6	7	V
I_{CES}	Collector cut-off current	$V_{GE} = 0\text{ V}$, $V_{CE} = 650\text{ V}$			25	μA
I_{GES}	Gate-emitter leakage current	$V_{CE} = 0\text{ V}$, $V_{GE} = \pm 20\text{ V}$			± 250	μA

Table 5: Dynamic characteristics

Symbol	Parameter	Test conditions	Min.	Typ.	Max.	Unit
C_{ies}	Input capacitance	$V_{CE} = 25\text{ V}$, $f = 1\text{ MHz}$, $V_{GE} = 0\text{ V}$	-	2490	-	pF
C_{oes}	Output capacitance		-	143	-	
C_{res}	Reverse transfer capacitance		-	46	-	
Q_g	Total gate charge	$V_{CC} = 520\text{ V}$, $I_C = 30\text{ A}$, $V_{GE} = 0\text{ to }15\text{ V}$ (see Figure 30 : "Gate charge test circuit")	-	80	-	nC
Q_{ge}	Gate-emitter charge		-	18	-	
Q_{gc}	Gate-collector charge		-	32	-	

Table 6: IGBT switching characteristics (inductive load)

Symbol	Parameter	Test conditions	Min.	Typ.	Max.	Unit
$t_{d(on)}$	Turn-on delay time	$V_{CE} = 400\text{ V}$, $I_C = 30\text{ A}$, $V_{GE} = 15\text{ V}$, $R_G = 10\ \Omega$ (see Figure 29: "Test circuit for inductive load switching")		31.6	-	ns
t_r	Current rise time			13.4	-	ns
$(di/dt)_{on}$	Turn-on current slope			1791	-	A/ μ s
$t_{d(off)}$	Turn-off-delay time			115	-	ns
t_f	Current fall time			110	-	ns
$E_{on}^{(1)}$	Turn-on switching energy			0.3	-	mJ
$E_{off}^{(2)}$	Turn-off switching energy			0.96	-	mJ
E_{ts}	Total switching energy			1.26	-	mJ
$t_{d(on)}$	Turn-on delay time	$V_{CE} = 400\text{ V}$, $I_C = 30\text{ A}$, $V_{GE} = 15\text{ V}$, $R_G = 10\ \Omega$ $T_J = 175\text{ }^\circ\text{C}$ (see Figure 29: "Test circuit for inductive load switching")		30	-	ns
t_r	Current rise time			17	-	ns
$(di/dt)_{on}$	Turn-on current slope			1435	-	A/ μ s
$t_{d(off)}$	Turn-off-delay time			116	-	ns
t_f	Current fall time			194	-	ns
$E_{on}^{(1)}$	Turn-on switching energy			0.67	-	mJ
$E_{off}^{(2)}$	Turn-off switching energy			1.36	-	mJ
E_{ts}	Total switching energy			2.03	-	mJ
t_{sc}	Short-circuit withstand time	$V_{CC} \leq 400\text{ V}$, $V_{GE} = 13\text{ V}$, $T_{Jstart} = 150\text{ }^\circ\text{C}$	10		-	μ s
		$V_{CC} \leq 400\text{ V}$, $V_{GE} = 15\text{ V}$, $T_{Jstart} = 150\text{ }^\circ\text{C}$	6		-	

Notes:

(1)Including the reverse recovery of the diode.

(2)Including the tail of the collector current.

Table 7: Diode switching characteristics (inductive load)

Symbol	Parameter	Test conditions	Min.	Typ.	Max.	Unit
t_{rr}	Reverse recovery time	$I_F = 30\text{ A}$, $V_R = 400\text{ V}$, $V_{GE} = 15\text{ V}$, $di/dt = 1000\text{ A}/\mu\text{s}$ (see Figure 29: "Test circuit for inductive load switching")	-	140	-	ns
Q_{rr}	Reverse recovery charge		-	880	-	nC
I_{rrm}	Reverse recovery current		-	17	-	A
dl_{rr}/dt	Peak rate of fall of reverse recovery current during t_b		-	650	-	A/ μ s
E_{rr}	Reverse recovery energy		-	115	-	μ J
t_{rr}	Reverse recovery time	$I_F = 30\text{ A}$, $V_R = 400\text{ V}$, $V_{GE} = 15\text{ V}$, $di/dt = 1000\text{ A}/\mu\text{s}$, $T_J = 175\text{ }^\circ\text{C}$ (see Figure 29: "Test circuit for inductive load switching")	-	244	-	ns
Q_{rr}	Reverse recovery charge		-	2743	-	nC
I_{rrm}	Reverse recovery current		-	25	-	A
dl_{rr}/dt	Peak rate of fall of reverse recovery current during t_b		-	220	-	A/ μ s
E_{rr}	Reverse recovery energy		-	320	-	μ J

2.1 Electrical characteristics (curves)

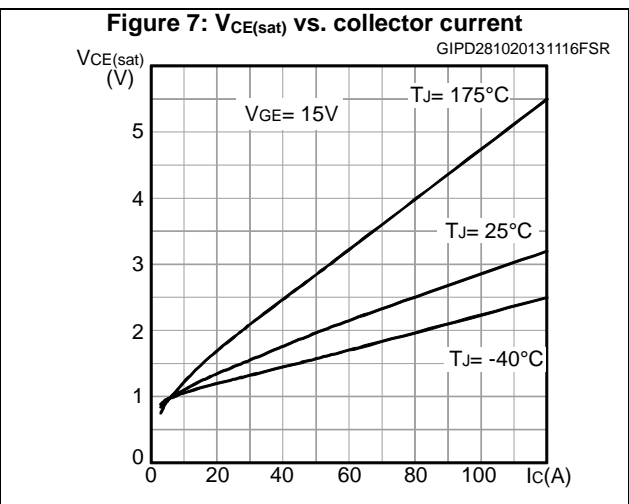
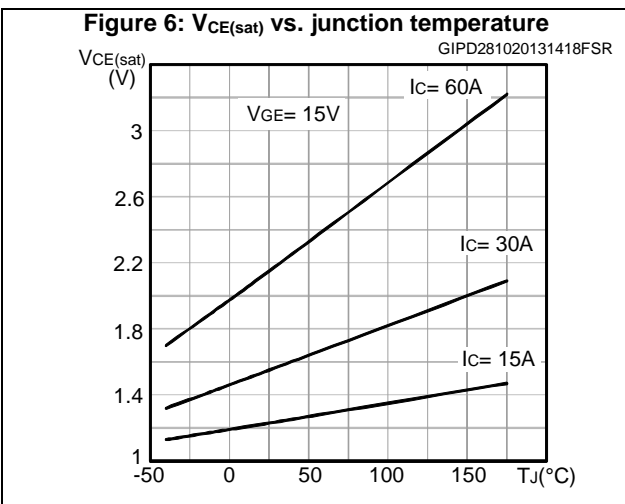
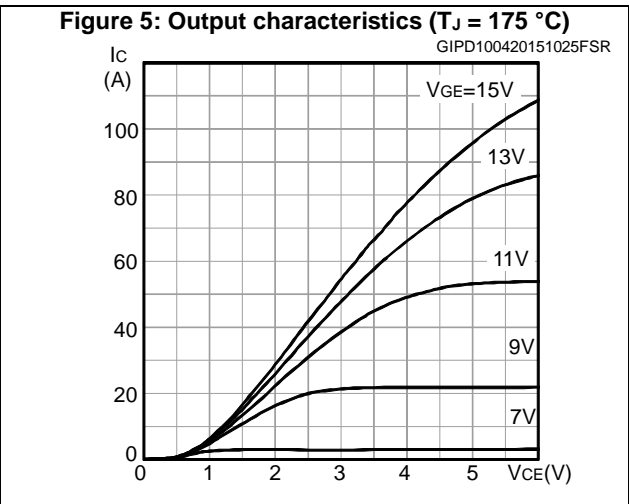
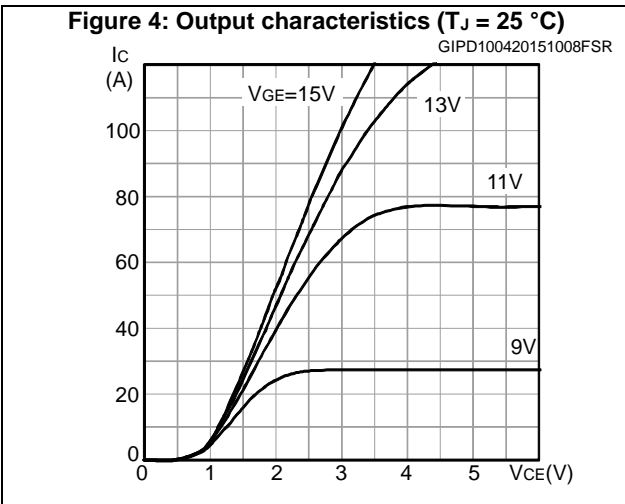
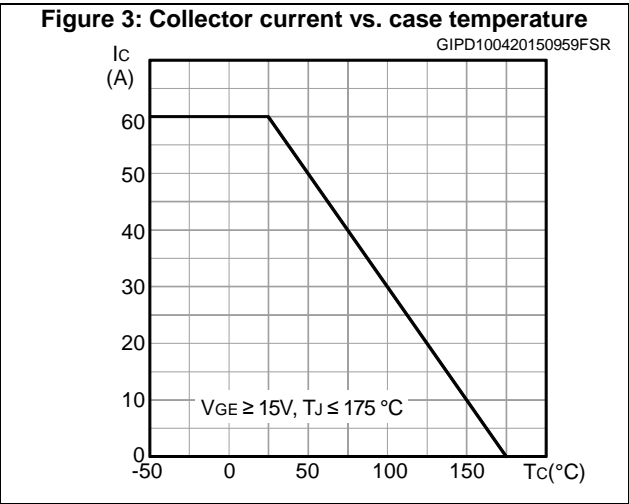
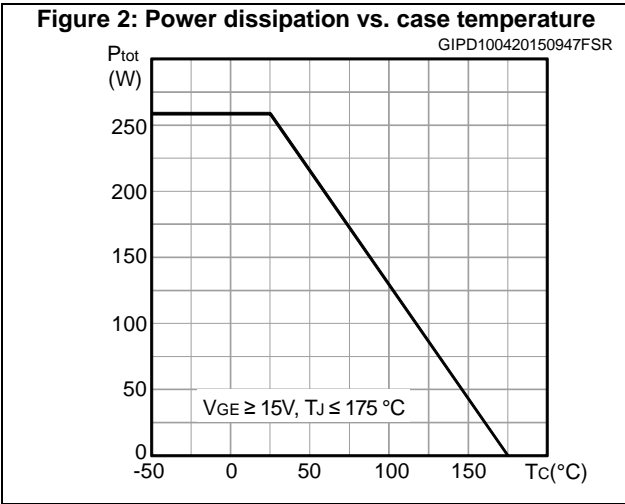

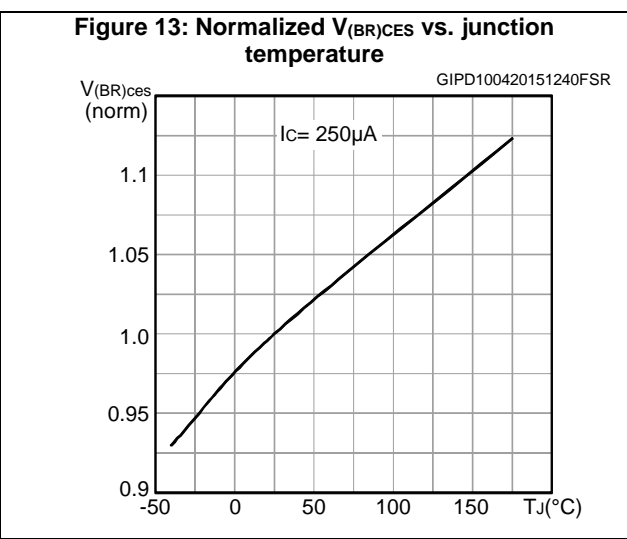
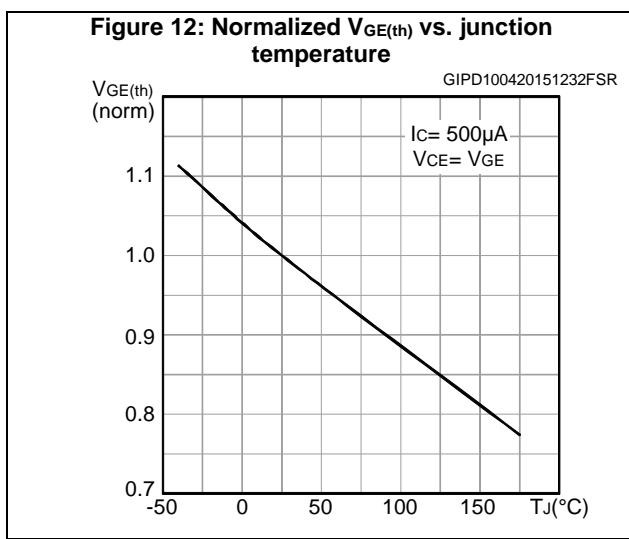
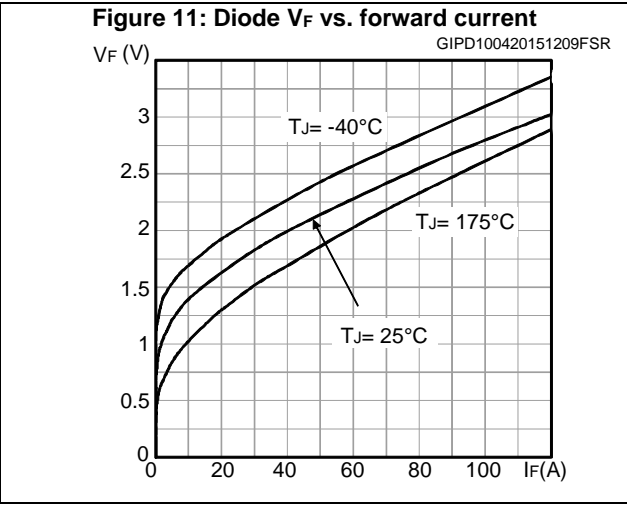
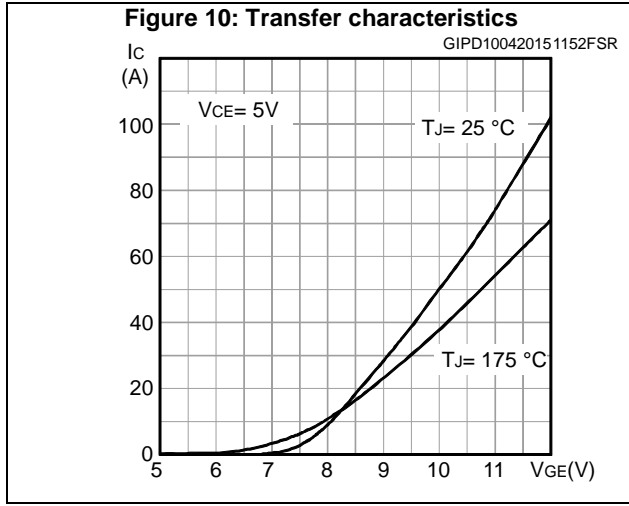
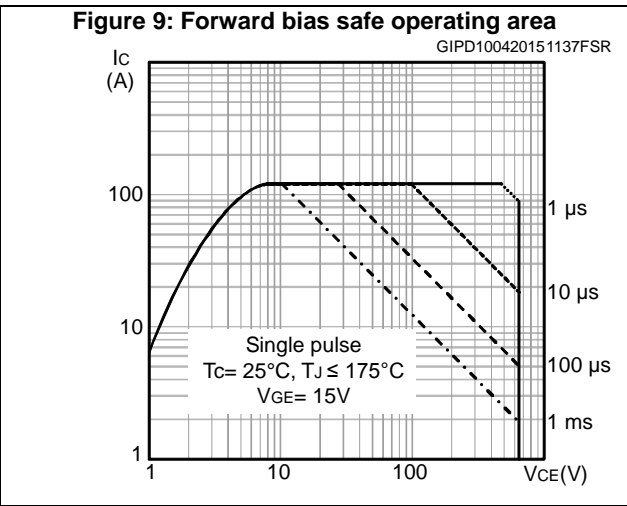
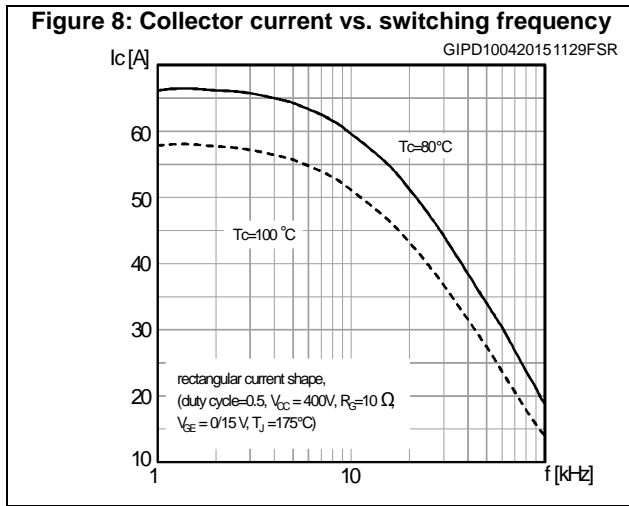

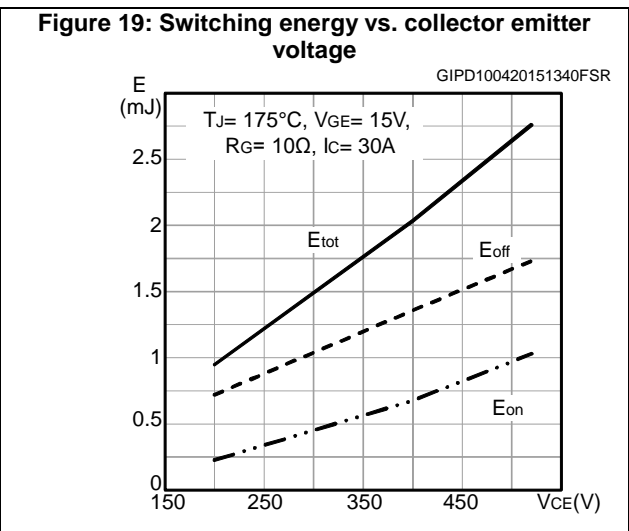
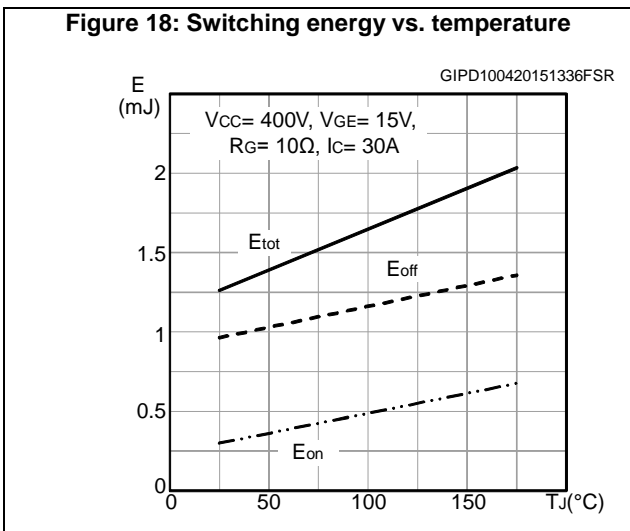
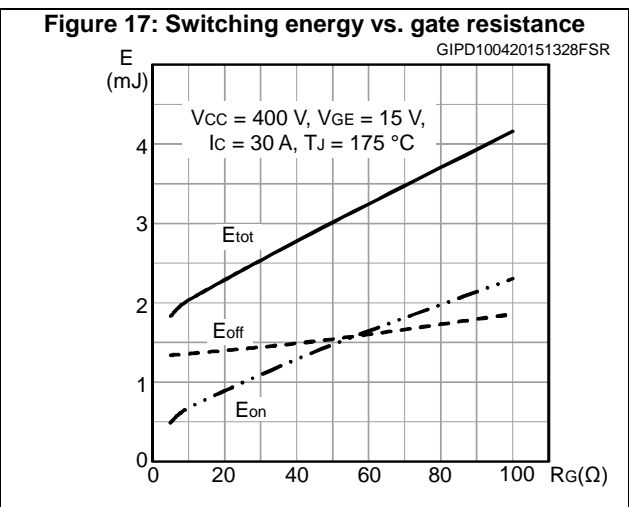
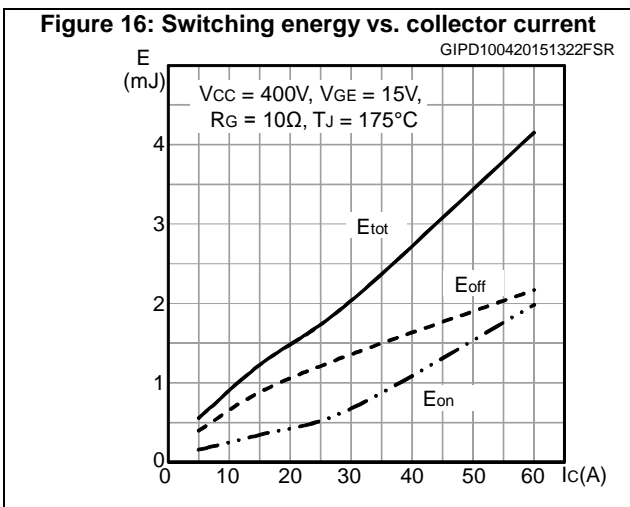
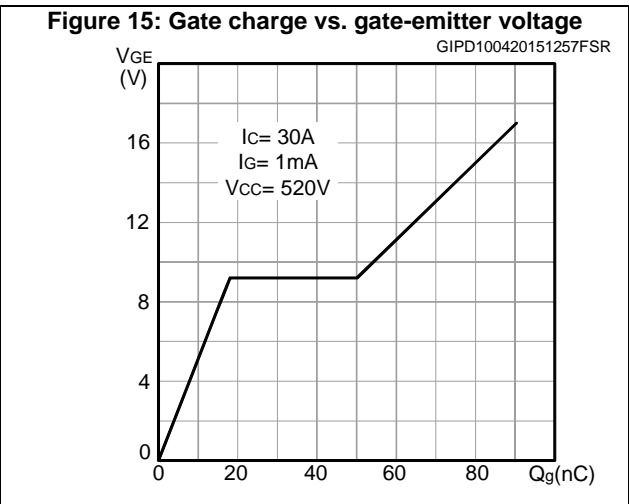
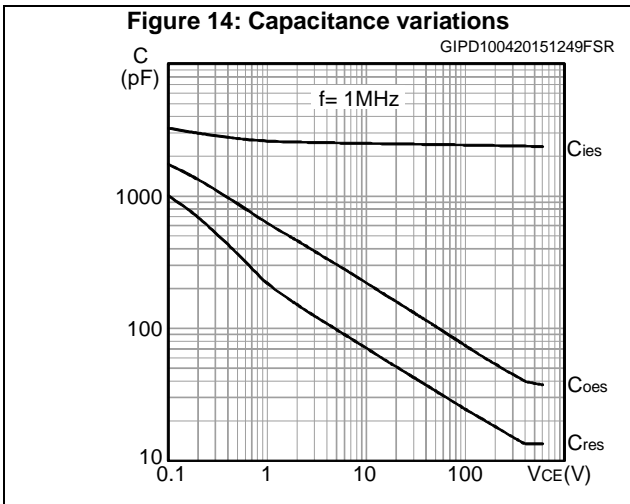

Figure 20: Short-circuit time and current vs. V_{GE}

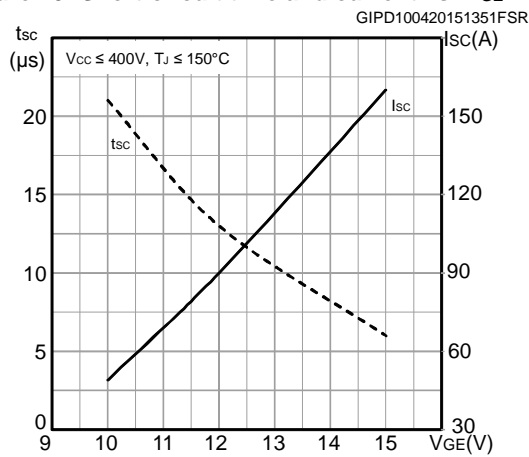

Figure 21: Switching times vs. collector current

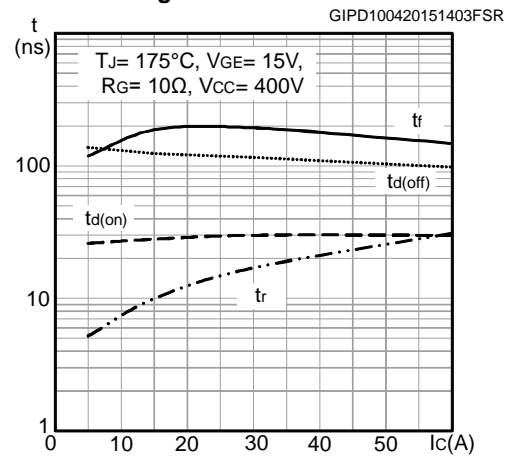

Figure 22: Switching times vs. gate resistance

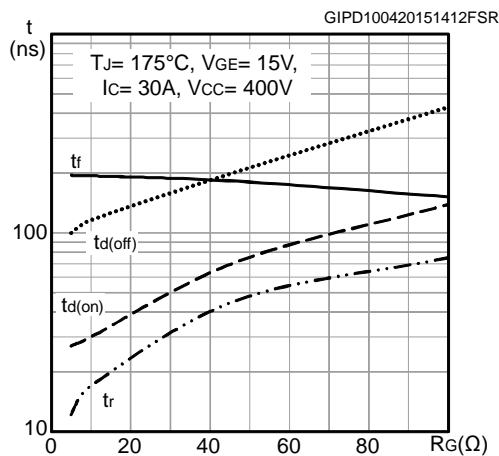

Figure 23: Reverse recovery current vs. diode current slope

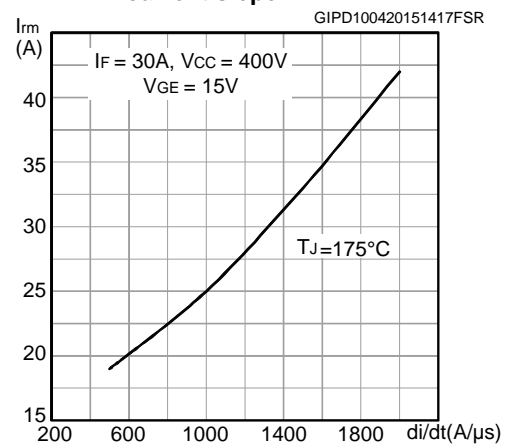

Figure 24: Reverse recovery time vs. diode current slope

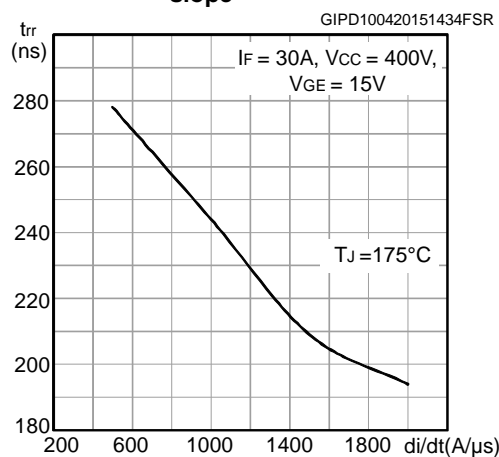

Figure 25: Reverse recovery charge vs. diode current slope

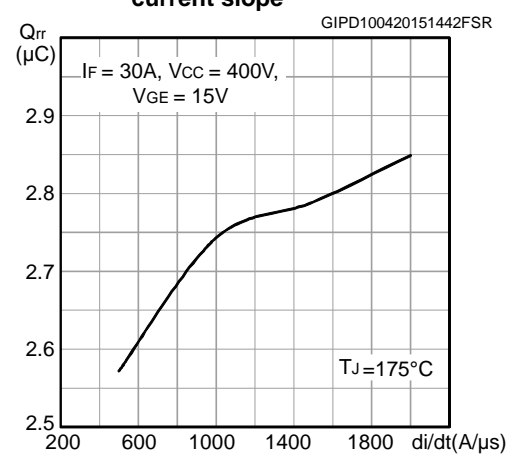

Figure 26: Reverse recovery energy vs. diode current slope

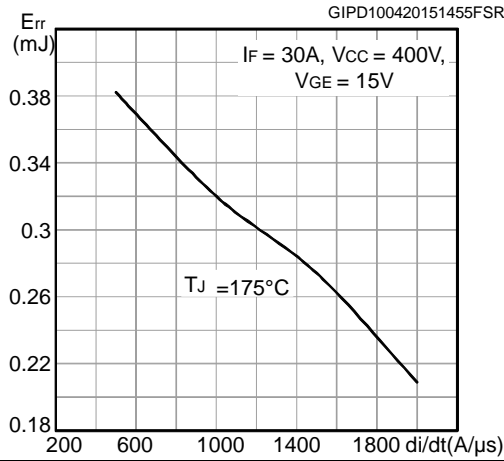

Figure 27: Thermal impedance for IGBT

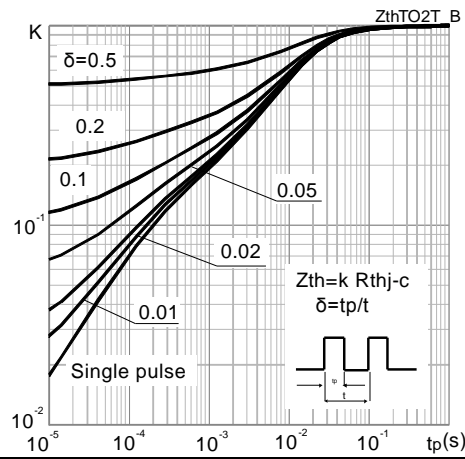
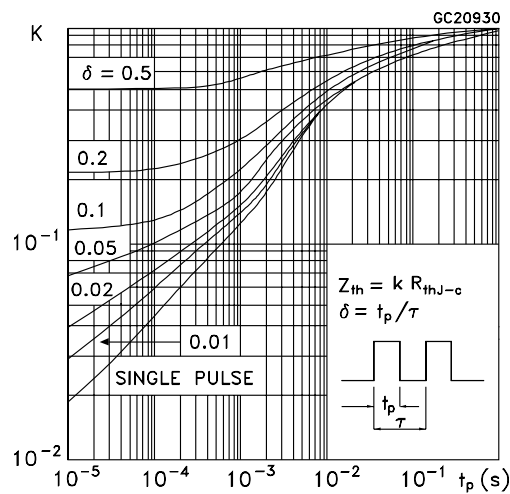
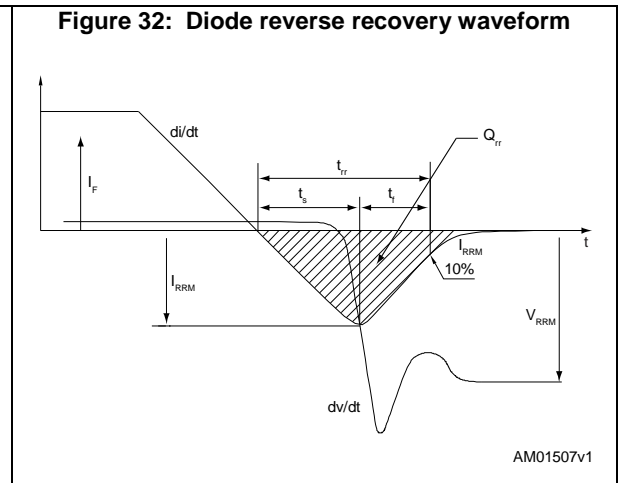
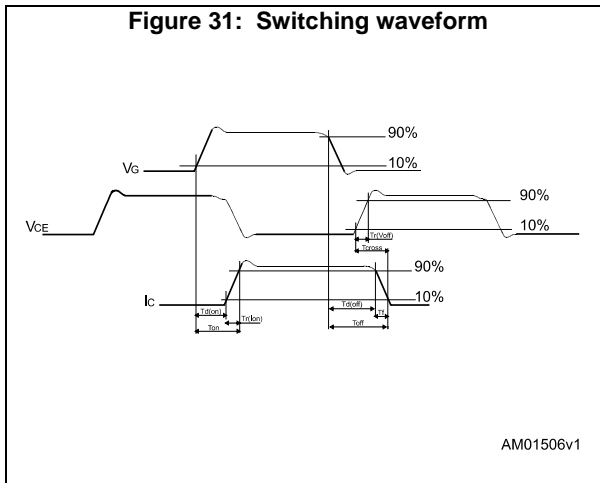
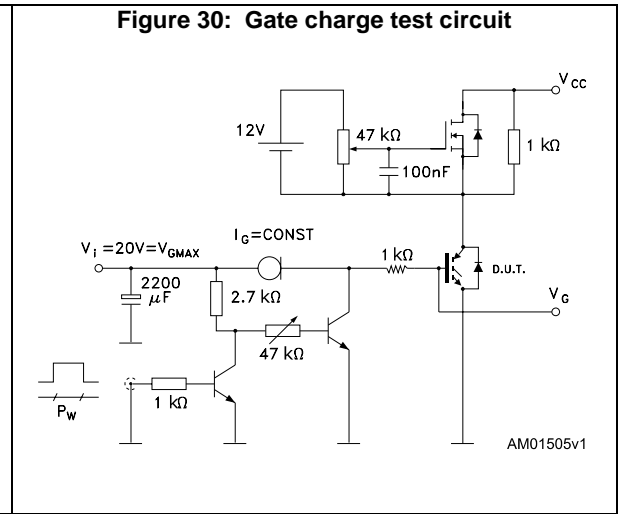
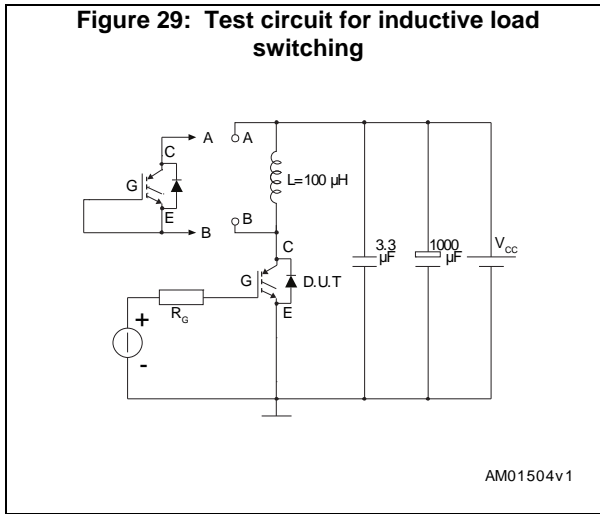

Figure 28: Thermal impedance for diode



3 Test circuits



4 Package information

In order to meet environmental requirements, ST offers these devices in different grades of ECOPACK® packages, depending on their level of environmental compliance. ECOPACK® specifications, grade definitions and product status are available at: www.st.com. ECOPACK® is an ST trademark.

4.1 D²PAK (TO-263) type A package information

Figure 33: D²PAK (TO-263) type A package outline

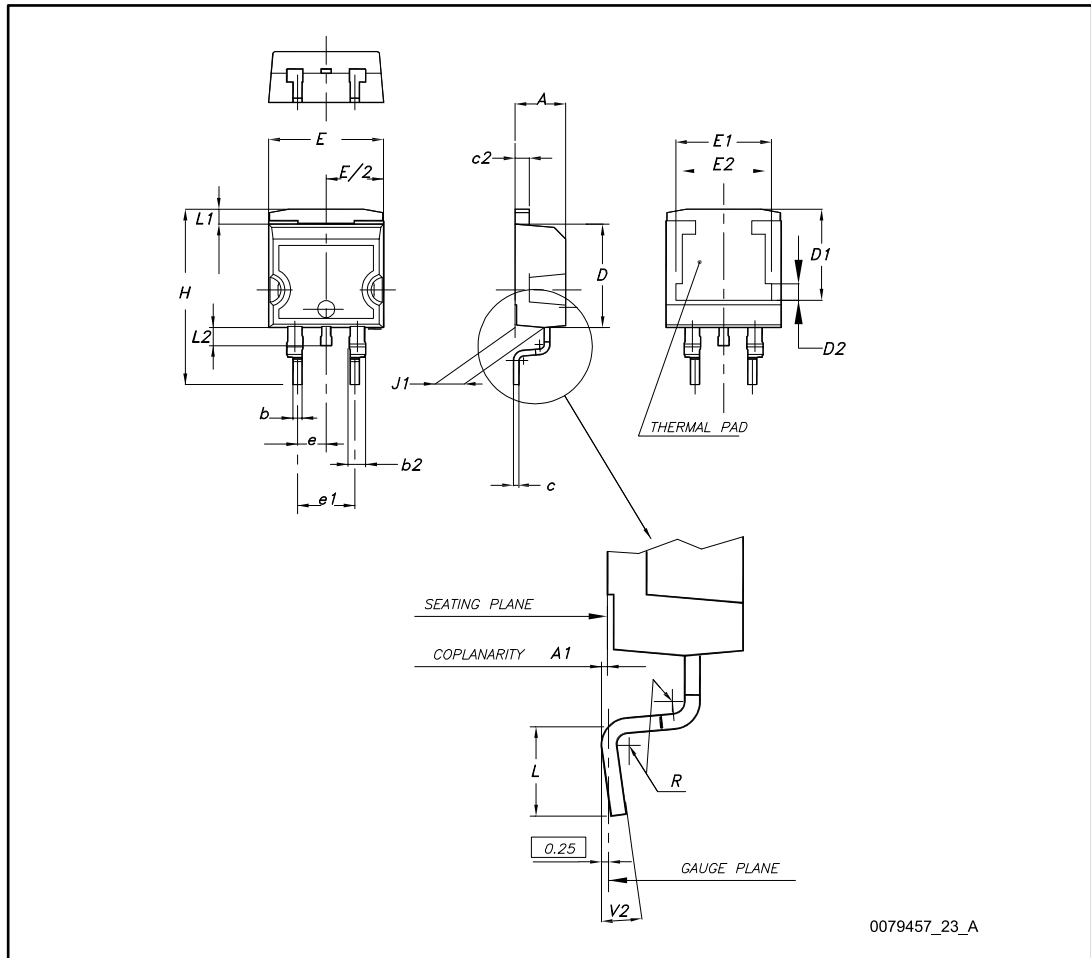
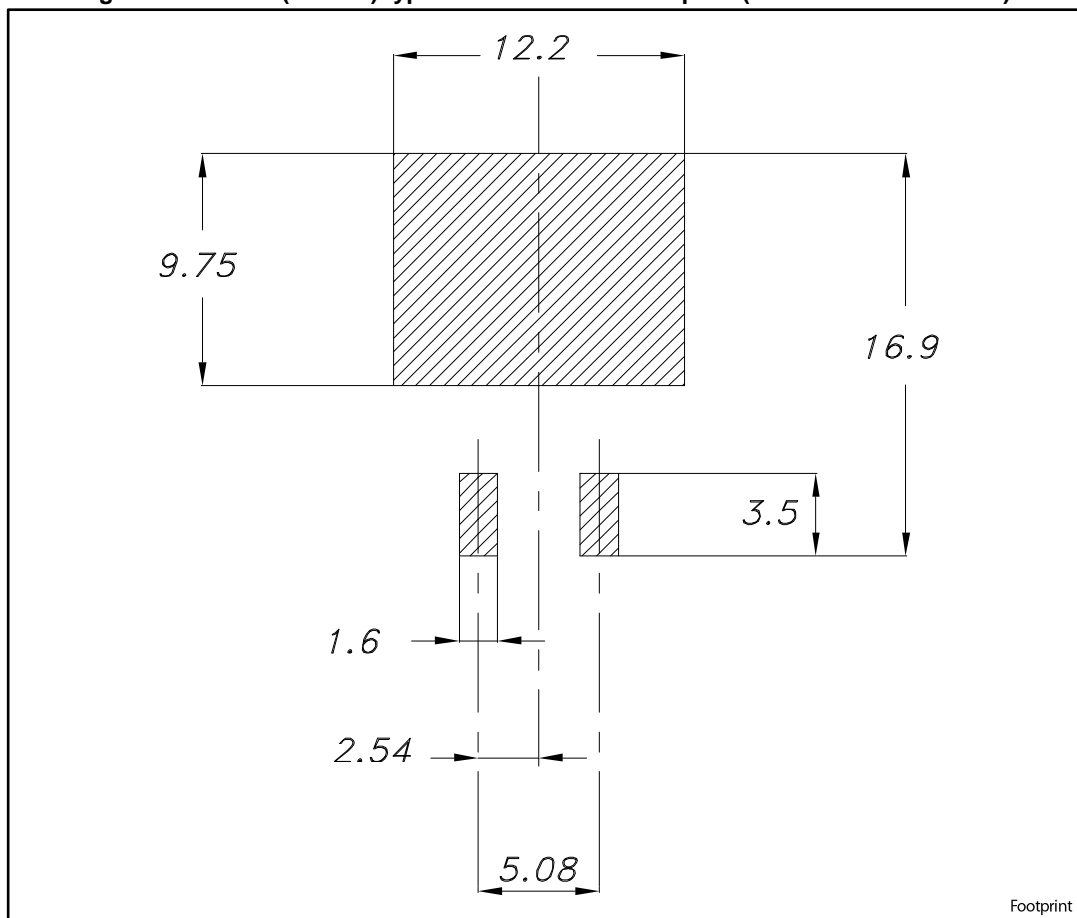

Table 8: D²PAK (TO-263) type A package mechanical data

Dim.	mm		
	Min.	Typ.	Max.
A	4.40		4.60
A1	0.03		0.23
b	0.70		0.93
b2	1.14		1.70
c	0.45		0.60
c2	1.23		1.36
D	8.95		9.35
D1	7.50	7.75	8.00
D2	1.10	1.30	1.50
E	10.00		10.40
E1	8.50	8.70	8.90
E2	6.85	7.05	7.25
e		2.54	
e1	4.88		5.28
H	15.00		15.85
J1	2.49		2.69
L	2.29		2.79
L1	1.27		1.40
L2	1.30		1.75
R		0.40	
V2	0°		8°

Figure 34: D²PAK (TO-263) type A recommended footprint (dimensions are in mm)



4.2 D²PAK (TO-263) type A packing information

Figure 35: D²PAK type A tape outline

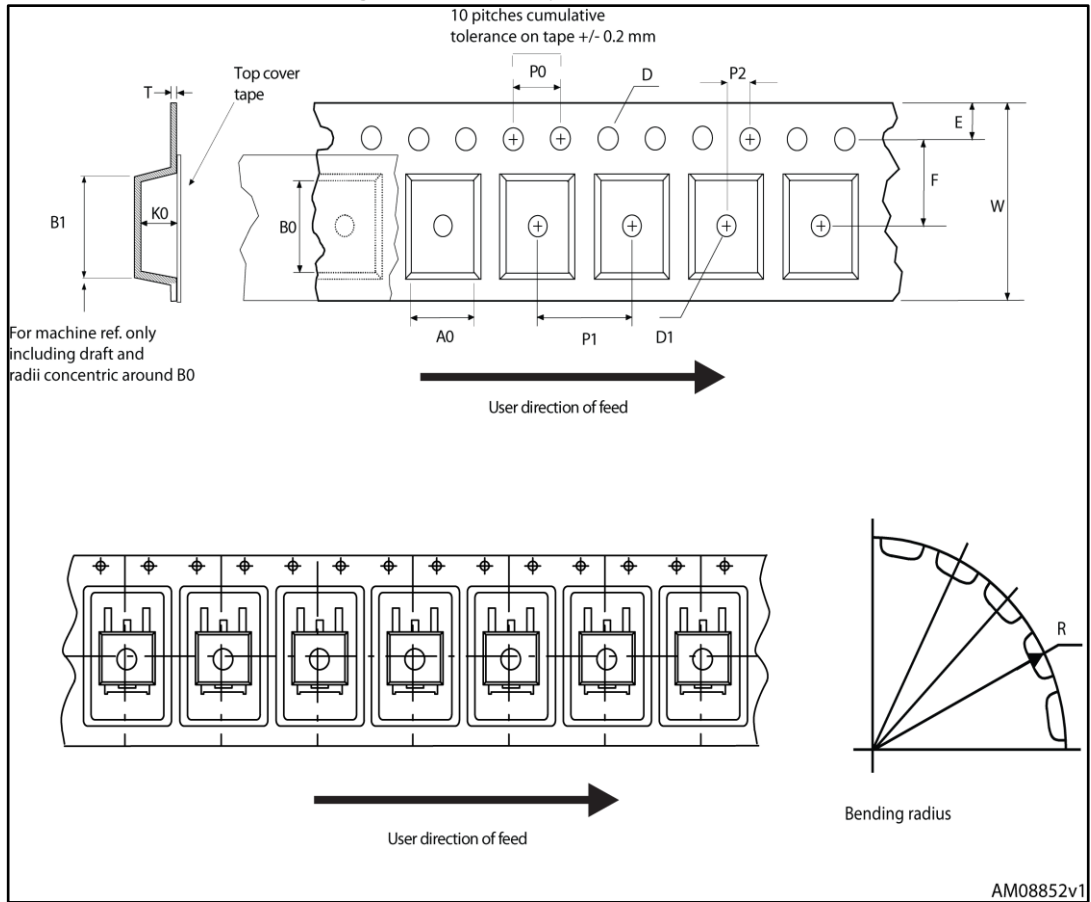

Figure 36: D²PAK type A reel outline

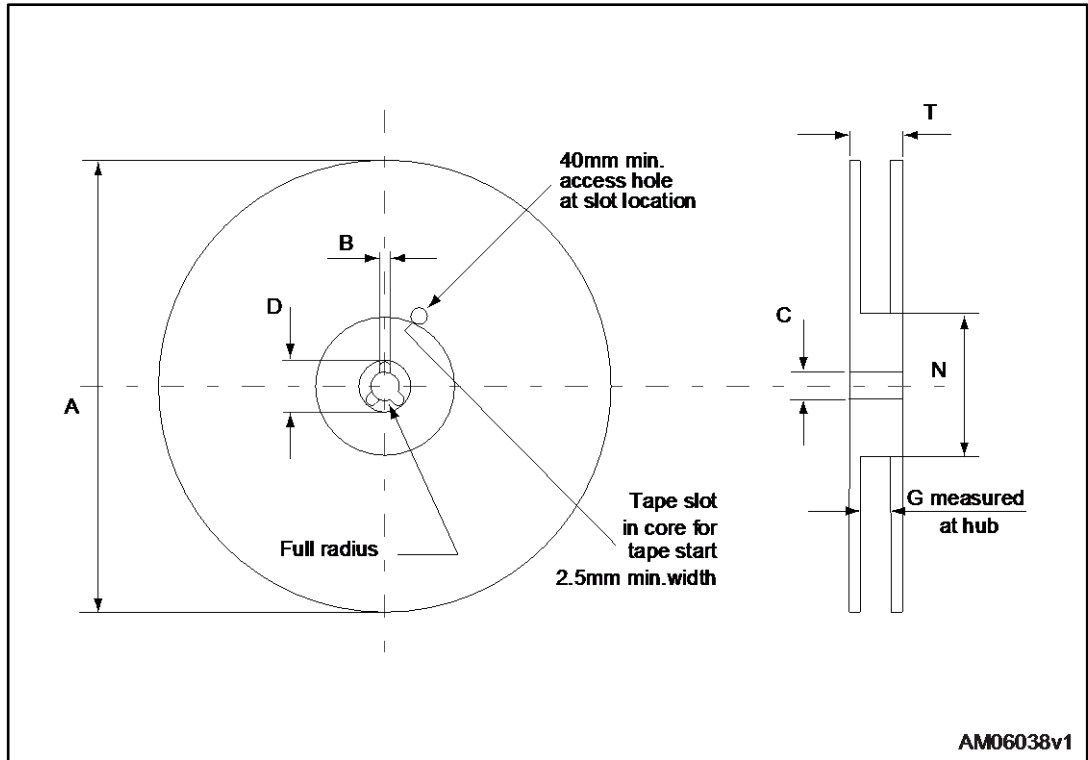

Table 9: D²PAK type A tape and reel mechanical data

Tape			Reel		
Dim.	mm		Dim.	mm	
	Min.	Max.		Min.	Max.
A0	10.5	10.7	A		330
B0	15.7	15.9	B	1.5	
D	1.5	1.6	C	12.8	13.2
D1	1.59	1.61	D	20.2	
E	1.65	1.85	G	24.4	26.4
F	11.4	11.6	N	100	
K0	4.8	5.0	T		30.4
P0	3.9	4.1			
P1	11.9	12.1	Base quantity		1000
P2	1.9	2.1	Bulk quantity		1000
R	50				
T	0.25	0.35			
W	23.7	24.3			

5 Revision history

Table 10: Document revision history

Date	Revision	Changes
10-Feb-2015	1	First release.
13-Apr-2015	2	Document status promoted from preliminary to production data. Updated <i>Section 2: "Electrical characteristics"</i> Added <i>Section 2.1: "1.1 Electrical characteristics (curve)"</i>
11-Apr-2017	3	Updated document title. Updated <i>Table 4: "Static characteristics"</i> , <i>Table 6: "IGBT switching characteristics (inductive load)"</i> and <i>Table 7: "Diode switching characteristics (inductive load)"</i> . Updated <i>Figure 13: "Normalized $V_{(BR)CES}$ vs. junction temperature"</i> . Updated <i>Section 4.1: "D²PAK (TO-263) type A package information"</i> . Minor text changes

IMPORTANT NOTICE – PLEASE READ CAREFULLY

STMicroelectronics NV and its subsidiaries ("ST") reserve the right to make changes, corrections, enhancements, modifications, and improvements to ST products and/or to this document at any time without notice. Purchasers should obtain the latest relevant information on ST products before placing orders. ST products are sold pursuant to ST's terms and conditions of sale in place at the time of order acknowledgement.

Purchasers are solely responsible for the choice, selection, and use of ST products and ST assumes no liability for application assistance or the design of Purchasers' products.

No license, express or implied, to any intellectual property right is granted by ST herein.

Resale of ST products with provisions different from the information set forth herein shall void any warranty granted by ST for such product.

ST and the ST logo are trademarks of ST. All other product or service names are the property of their respective owners.

Information in this document supersedes and replaces information previously supplied in any prior versions of this document.

© 2017 STMicroelectronics – All rights reserved

X-ON Electronics

Largest Supplier of Electrical and Electronic Components

Click to view similar products for [IGBT Transistors](#) category:

Click to view products by [STMicroelectronics](#) manufacturer:

Other Similar products are found below :

[748152A](#) [APT20GT60BRDQ1G](#) [APT50GT60BRG](#) [NGTB10N60FG](#) [STGFW20V60DF](#) [APT30GP60BG](#) [APT45GR65B2DU30](#)
[GT50JR22\(STA1ES\)](#) [TIG058E8-TL-H](#) [VS-CPV364M4KPBF](#) [NGTB25N120FL2WAG](#) [NGTG40N120FL2WG](#) [RJH60F3DPQ-A0#T0](#)
[APT40GR120B2SCD10](#) [APT15GT120BRG](#) [APT20GT60BRG](#) [NGTB75N65FL2WAG](#) [NGTG15N120FL2WG](#) [IXA30RG1200DHGLB](#)
[IXA40RG1200DHGLB](#) [APT70GR65B2DU40](#) [NTE3320](#) [IHF40N65R5SXXKSA1](#) [APT70GR120J](#) [APT35GP120JDQ2](#)
[IKZA40N65RH5XKSA1](#) [IKFW75N65ES5XKSA1](#) [IKFW50N65ES5XKSA1](#) [IKFW50N65EH5XKSA1](#) [IKFW40N65ES5XKSA1](#)
[IKFW60N65ES5XKSA1](#) [IMBG120R090M1HXTMA1](#) [IMBG120R220M1HXTMA1](#) [XD15H120CX1](#) [XD25H120CX0](#) [XP15PJS120CL1B1](#)
[IGW30N60H3FKSA1](#) [STGWA8M120DF3](#) [IGW08T120FKSA1](#) [IGW75N60H3FKSA1](#) [HGTG40N60B3](#) [FGH60N60SMD_F085](#)
[FGH75T65UPD](#) [STGWA15H120F2](#) [IKA10N60TXKSA1](#) [IHW20N120R5XKSA1](#) [RJH60D2DPP-M0#T2](#) [IKP20N60TXKSA1](#)
[IHW20N65R5XKSA1](#) [IDW40E65D2FKSA1](#)