



# STGB14NC60K STGD14NC60K

N-channel 14A - 600V - DPAK - D<sup>2</sup>PAK  
Short circuit rated PowerMESH™ IGBT

## General features

Type	V <sub>CES</sub>	V <sub>CE(sat)</sub> (Max)@ 25°C	I <sub>C</sub> @100°C
STGB14NC60K	600V	<2.5V	14A
STGD14NC60K	600V	<2.5V	14A

- Low on-voltage drop (V<sub>cesat</sub>)
- Low C<sub>res</sub> / C<sub>ies</sub> ratio ( no cross conduction susceptibility)
- Short circuit withstand time 10μs

## Description

Using the latest high voltage technology based on a patented strip layout, STMicroelectronics has designed an advanced family of IGBTs, the Power MESH™ IGBTs, with outstanding performances. The suffix "K" identifies a family optimized for high frequency motor control applications with short circuit withstand capability.

## Applications

- High frequency inverters
- Motor drivers with short circuit protection

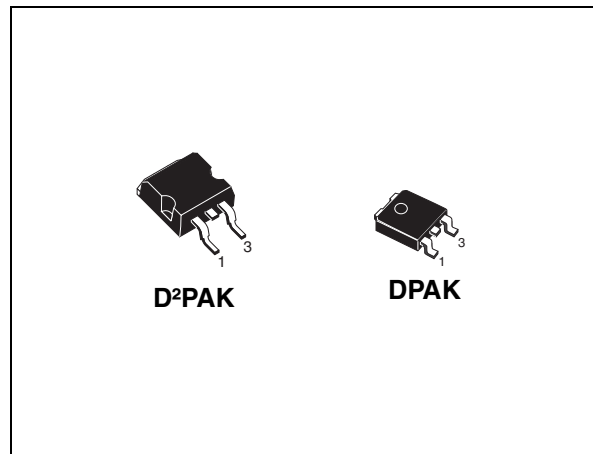

## Internal schematic diagram

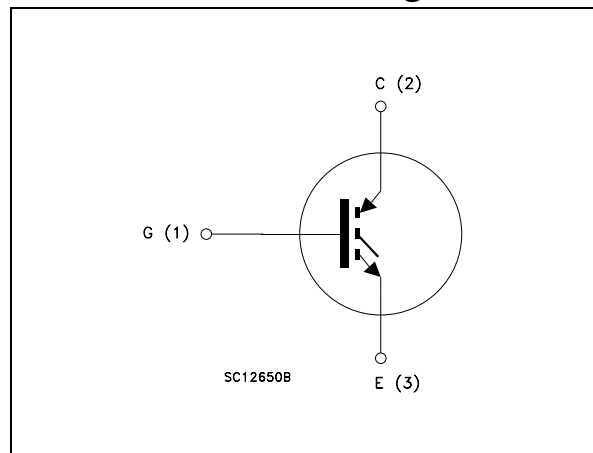

## Order codes

Part number	Marking	Package	Packaging
STGB14NC60KT4	GB14NC60K	D <sup>2</sup> PAK	Tape & reel
STGD14NC60KT4	GD14NC60K	DPAK	Tape & reel

# Contents

<b>1</b>	<b>Electrical ratings</b> .....	<b>3</b>
<b>2</b>	<b>Electrical characteristics</b> .....	<b>4</b>
2.1	Electrical characteristics (curves) .....	6
<b>3</b>	<b>Test circuit</b> .....	<b>9</b>
<b>4</b>	<b>Package mechanical data</b> .....	<b>10</b>
<b>5</b>	<b>Packaging mechanical data</b> .....	<b>13</b>
<b>6</b>	<b>Revision history</b> .....	<b>15</b>

# 1 Electrical ratings

**Table 1. Absolute maximum ratings**

Symbol	Parameter	Value	Unit
$V_{CES}$	Collector-emitter voltage ( $V_{GS} = 0$ )	600	V
$I_C^{(1)}$	Collector current (continuous) at $T_C = 25^\circ\text{C}$	25	A
$I_C^{(1)}$	Collector current (continuous) at $T_C = 100^\circ\text{C}$	14	A
$I_{CL}^{(2)}$	Collector current (pulsed)	50	A
$V_{GE}$	Gate-emitter voltage	$\pm 20$	V
$P_{TOT}$	Total dissipation at $T_C = 25^\circ\text{C}$	80	W
$t_{scw}$	Short circuit withstand time, $V_{CE} = 0.5V_{BR(CES)}$ , $T_J = 125^\circ\text{C}$ , $R_G = 10\Omega$ , $V_{GE} = 12\text{V}$	10	$\mu\text{s}$
$T_{stg}$	Storage temperature	- 55 to 150	$^\circ\text{C}$
$T_j$	Operating junction temperature		

1. Calculated according to the iterative formula:

$$I_C(T_C) = \frac{T_{JMAX} - T_C}{R_{THJ-C} \times V_{CESAT(MAX)}(T_C, I_C)}$$

2.  $V_{clamp} = 480\text{V}$ ,  $T_J = 150^\circ\text{C}$ ,  $R_G = 10\Omega$ ,  $V_{GE} = 15\text{V}$

**Table 2. Thermal resistance**

Symbol	Parameter	Value	Unit
$R_{thj-case}$	Thermal resistance junction-case max	1.25	$^\circ\text{C}/\text{W}$
$R_{thj-amb}$	Thermal resistance junction-ambient max	62.5	$^\circ\text{C}/\text{W}$

## 2 Electrical characteristics

( $T_{CASE}=25^{\circ}\text{C}$  unless otherwise specified)

**Table 3. Static**

Symbol	Parameter	Test conditions	Min.	Typ.	Max.	Unit
$V_{BR(CES)}$	Collector-emitter breakdown voltage	$I_C = 1\text{mA}$ , $V_{GE} = 0$	600			V
$I_{GES}$	Gate-emitter leakage current ( $V_{CE} = 0$ )	$V_{GE} = \pm 20\text{V}$ , $V_{CE} = 0$			$\pm 100$	nA
$I_{CES}$	Collector cut-off current ( $V_{GE} = 0$ )	$V_{CE} = \text{Max rating}$ , $T_C = 25^{\circ}\text{C}$ $V_{CE} = \text{Max rating}$ , $T_C = 125^{\circ}\text{C}$			150 1	$\mu\text{A}$ mA
$V_{GE(th)}$	Gate threshold voltage	$V_{CE} = V_{GE}$ , $I_C = 250\mu\text{A}$	4.5		6.5	V
$V_{CE(SAT)}$	Collector-emitter saturation voltage	$V_{GE} = 15\text{V}$ , $I_C = 7\text{A}$ $V_{GE} = 15\text{V}$ , $I_C = 7\text{A}$ , $T_C = 125^{\circ}\text{C}$		2.0 1.8	2.5	V V
$g_{fs}^{(1)}$	Forward transconductance	$V_{CE} = 15\text{V}$ , $I_C = 7\text{A}$		3		S

1. Pulsed: Pulse duration = 300  $\mu\text{s}$ , duty cycle 1.5%

**Table 4. Dynamic**

Symbol	Parameter	Test conditions	Min.	Typ.	Max.	Unit
$C_{ies}$	Input capacitance	$V_{CE} = 25\text{V}$ , $f = 1\text{MHz}$ , $V_{GE} = 0$		760		pF
$C_{oes}$	Output capacitance			86		pF
$C_{res}$	Reverse transfer capacitance			15.5		pF
$Q_g$	Total gate charge	$V_{CE} = 390\text{V}$ , $I_C = 7\text{A}$ ,		34.4		nC
$Q_{ge}$	Gate-emitter charge	$V_{GE} = 15\text{V}$		8.1		nC
$Q_{gc}$	Gate-collector charge	(see Figure 17)		16.4		nC

**Table 5. Switching on/off (inductive load)**

Symbol	Parameter	Test conditions	Min.	Typ.	Max.	Unit
$t_{d(on)}$	Turn-on delay time	$V_{CC} = 390V, I_C = 7A$		22.5		ns
$t_r$	Current rise time	$R_G = 10\Omega, V_{GE} = 15V,$		8.5		ns
$(di/dt)_{on}$	Turn-on current slope	$T_J = 25^\circ C$ (see Figure 16)		700		A/ $\mu s$
$t_{d(on)}$	Turn-on delay time	$V_{CC} = 390V, I_C = 7A$		22		ns
$t_r$	Current rise time	$R_G = 10\Omega, V_{GE} = 15V,$		9.5		ns
$(di/dt)_{on}$	Turn-on current slope	$T_J = 125^\circ C$ (see Figure 16)		680		A/ $\mu s$
$t_r(V_{off})$	Off voltage rise time	$V_{CC} = 390V, I_C = 7A,$		60		ns
$t_{d(off)}$	Turn-off delay time	$R_{GE} = 10\Omega, V_{GE} = 15V$		116		ns
$t_f$	Current fall time	$T_J = 25^\circ C$ (see Figure 16)		75		ns
$t_r(V_{off})$	Off voltage rise time	$V_{CC} = 390V, I_C = 7A,$		24		ns
$t_{d(off)}$	Turn-off delay time	$R_{GE} = 10\Omega, V_{GE} = 15V$		196		ns
$t_f$	Current fall time	$T_J = 125^\circ C$ (see Figure 16)		144		ns

**Table 6. Switching energy (inductive load)**

Symbol	Parameter	Test conditions	Min	Typ.	Max	Unit
$E_{on}^{(1)}$	Turn-on switching losses	$V_{CC} = 390V, I_C = 7A$		82		$\mu J$
$E_{off}^{(2)}$	Turn-off switching losses	$R_G = 10\Omega, V_{GE} = 15V,$		155		$\mu J$
$E_{ts}$	Total switching losses	$T_J = 25^\circ C$ (see Figure 16)		237		$\mu J$
$E_{on}^{(1)}$	Turn-on switching losses	$V_{CC} = 390V, I_C = 7A$		131		$\mu J$
$E_{off}^{(2)}$	Turn-off switching losses	$R_G = 10\Omega, V_{GE} = 15V,$		370		$\mu J$
$E_{ts}$	Total switching losses	$T_J = 125^\circ C$ (see Figure 16)		501		$\mu J$

1.  $E_{on}$  is the turn-on losses when a typical diode is used in the test circuit in figure 2. If the IGBT is offered in a package with a co-pack diode, the co-pack diode is used as external diode. IGBTs & DIODE are at the same temperature (25°C and 125°C)
2. Turn-off losses include also the tail of the collector current.

## 2.1 Electrical characteristics (curves)

Figure 1. Output characteristics

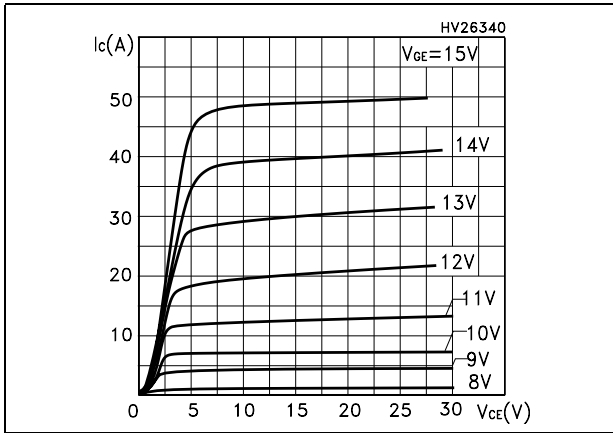

Figure 2. Transfer characteristics

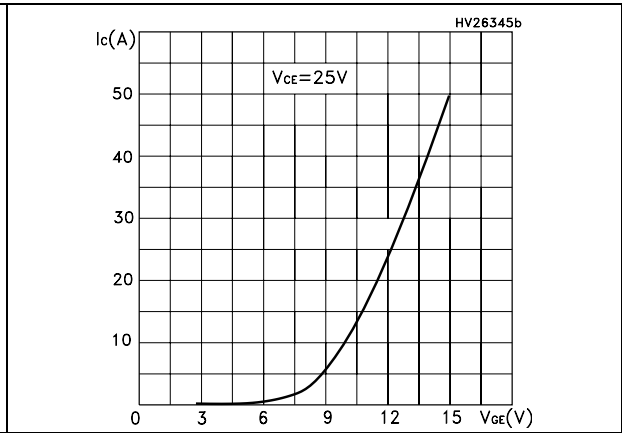

Figure 3. Transconductance

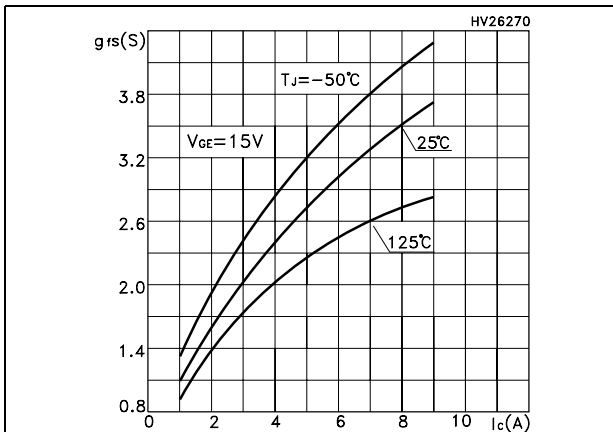

Figure 4. Collector-emitter on voltage vs temperature

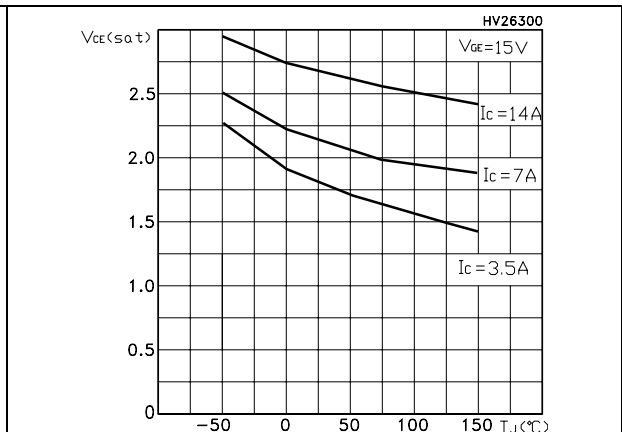

Figure 5. Collector-emitter on voltage vs collector current

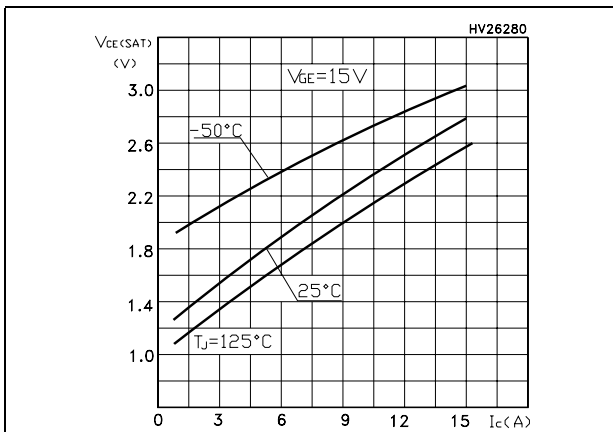

Figure 6. Normalized gate threshold vs temperature

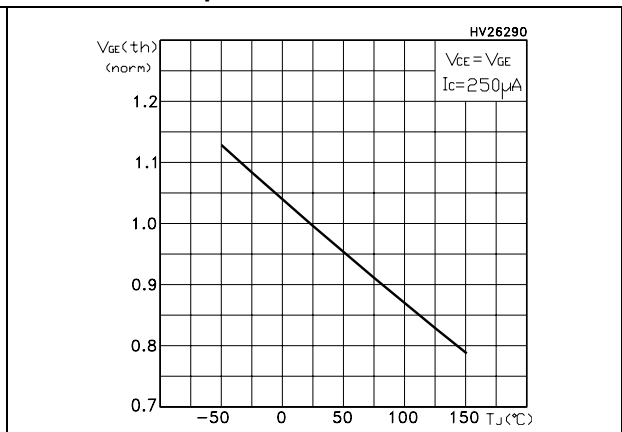

Figure 7. Normalized breakdown voltage vs temperature

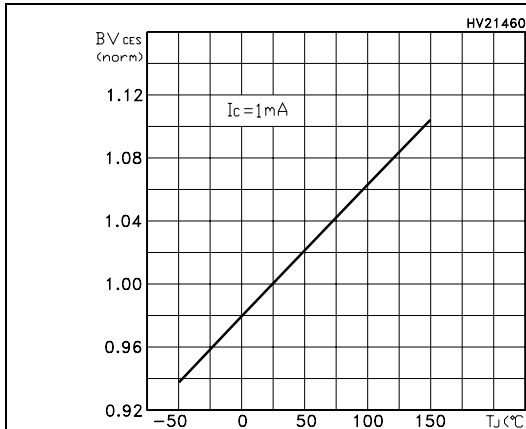

Figure 8. Gate charge vs gate-emitter voltage

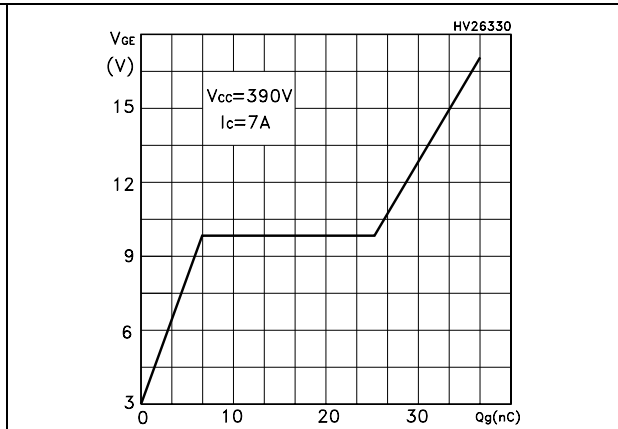

Figure 9. Capacitance variations

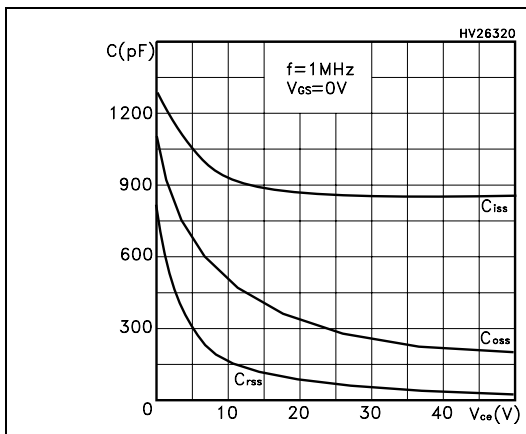

Figure 10. Switching losses vs temperature

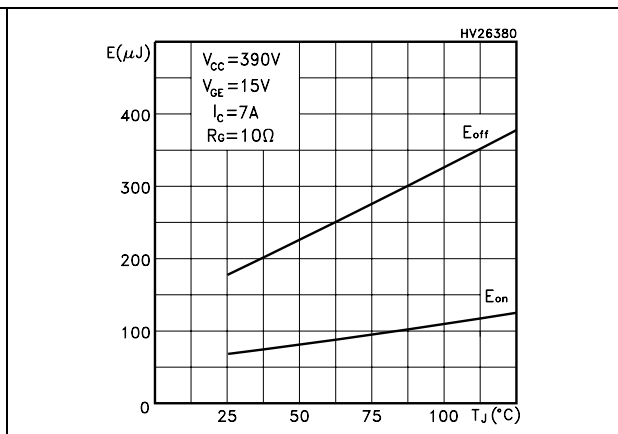

Figure 11. Switching losses vs gate resistance Figure 12. Switching losses vs collector current

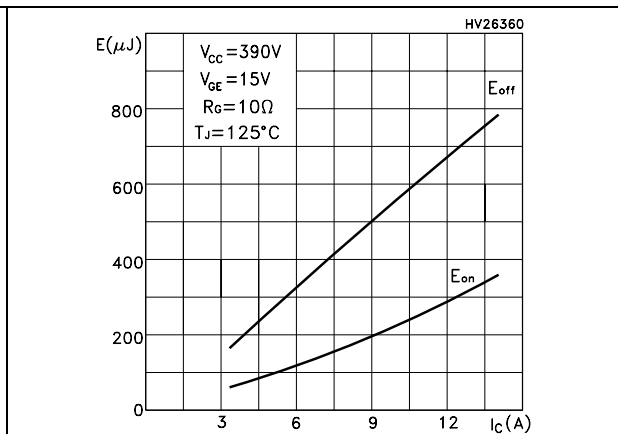
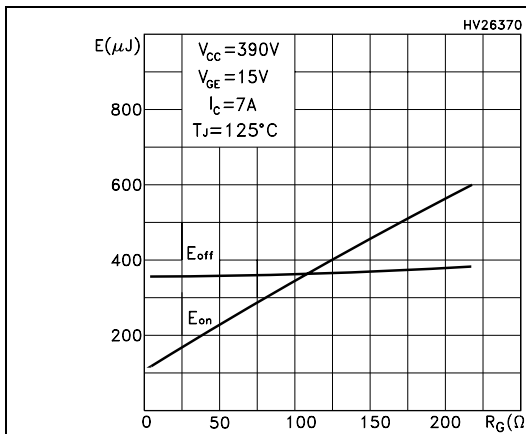

Figure 13. Thermal impedance

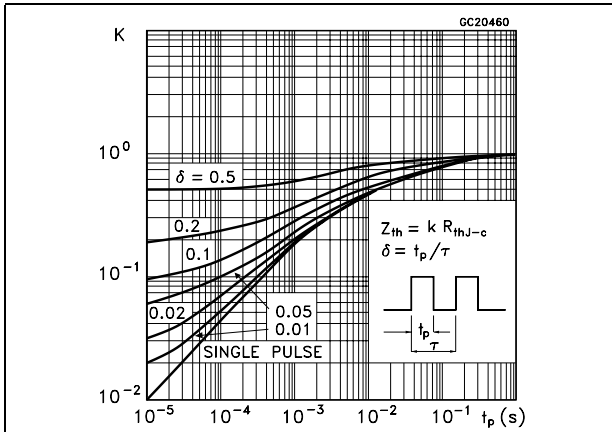

Figure 14. Turn-off SOA

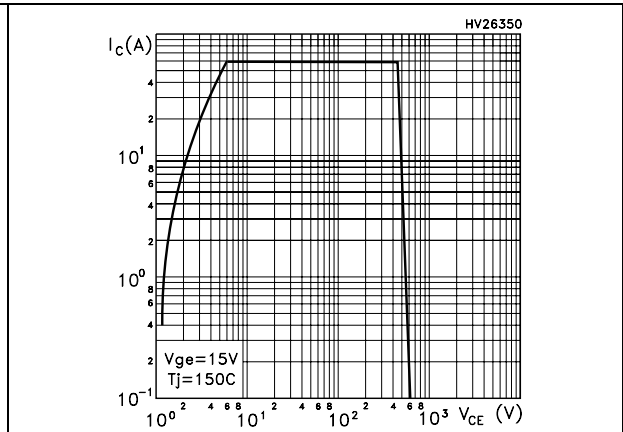
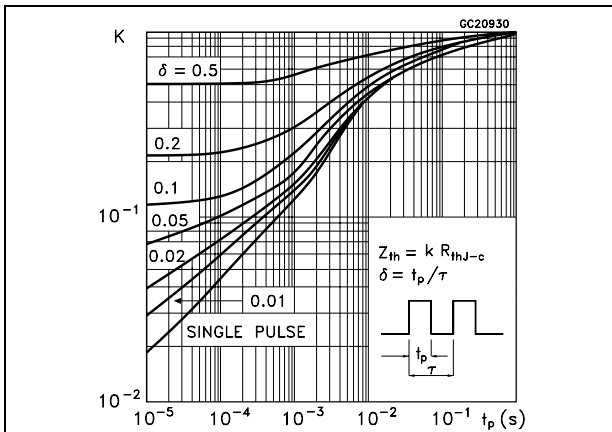

Figure 15. Thermal impedance for D<sup>2</sup>PAK







## 4 Package mechanical data

In order to meet environmental requirements, ST offers these devices in ECOPACK® packages. These packages have a Lead-free second level interconnect . The category of second level interconnect is marked on the package and on the inner box label, in compliance with JEDEC Standard JESD97. The maximum ratings related to soldering conditions are also marked on the inner box label. ECOPACK is an ST trademark. ECOPACK specifications are available at: [www.st.com](http://www.st.com)

**D<sup>2</sup>PAK MECHANICAL DATA**

DIM.	mm.			inch		
	MIN.	TYP	MAX.	MIN.	TYP.	MAX.
A	4.4		4.6	0.173		0.181
A1	2.49		2.69	0.098		0.106
A2	0.03		0.23	0.001		0.009
B	0.7		0.93	0.027		0.036
B2	1.14		1.7	0.044		0.067
C	0.45		0.6	0.017		0.023
C2	1.23		1.36	0.048		0.053
D	8.95		9.35	0.352		0.368
D1		8			0.315	
E	10		10.4	0.393		
E1		8.5			0.334	
G	4.88		5.28	0.192		0.208
L	15		15.85	0.590		0.625
L2	1.27		1.4	0.050		0.055
L3	1.4		1.75	0.055		0.068
M	2.4		3.2	0.094		0.126
R		0.4			0.015	
V2	0°		4°			

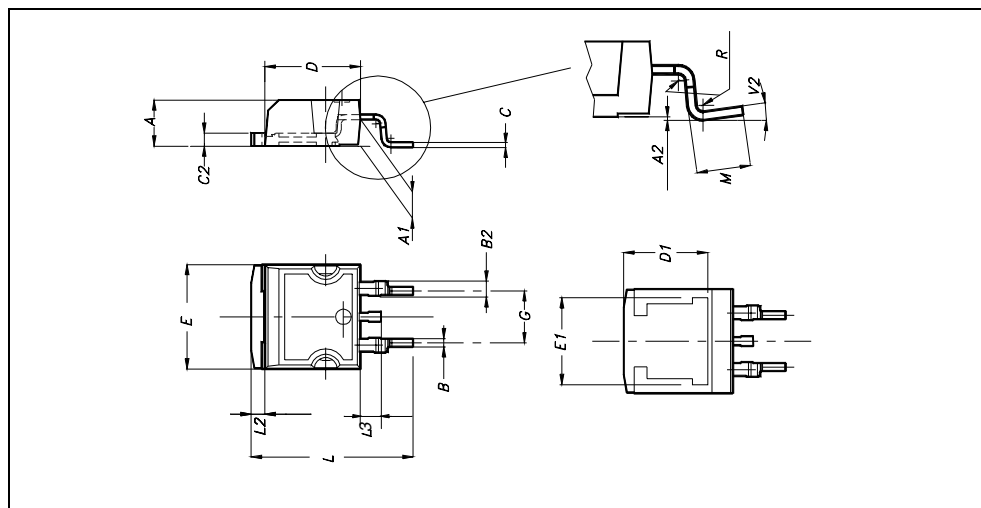

**DPAK MECHANICAL DATA**

DIM.	mm.			inch		
	MIN.	TYP.	MAX.	MIN.	TYP.	MAX.
A	2.2		2.4	0.086		0.094
A1	0.9		1.1	0.035		0.043
A2	0.03		0.23	0.001		0.009
B	0.64		0.9	0.025		0.035
b4	5.2		5.4	0.204		0.212
C	0.45		0.6	0.017		0.023
C2	0.48		0.6	0.019		0.023
D	6		6.2	0.236		0.244
D1		5.1			0.200	
E	6.4		6.6	0.252		0.260
E1		4.7			0.185	
e		2.28			0.090	
e1	4.4		4.6	0.173		0.181
H	9.35		10.1	0.368		0.397
L	1			0.039		
(L1)		2.8			0.110	
L2		0.8			0.031	
L4	0.6		1	0.023		0.039
R		0.2			0.008	
V2	0°		8°	0°		8°

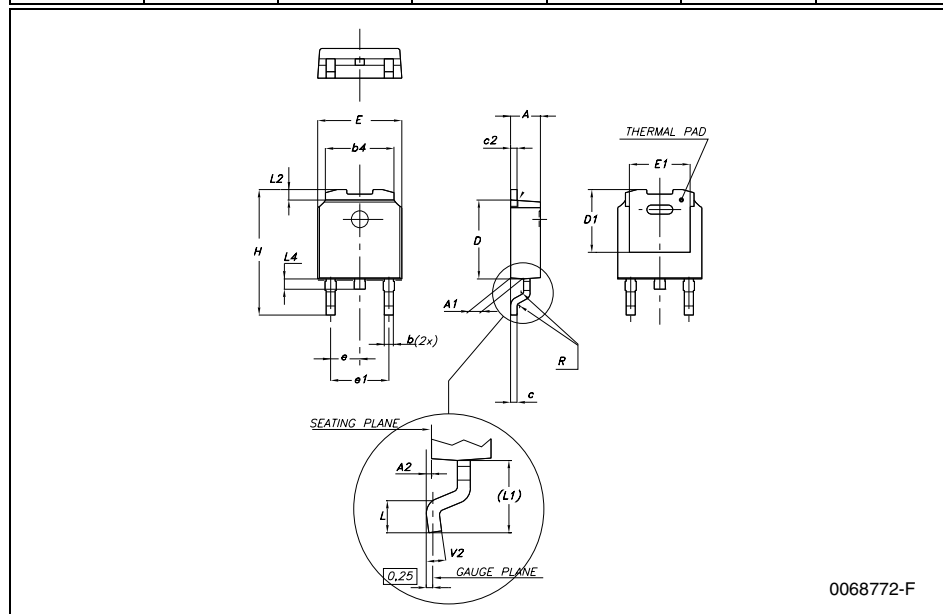

## 5 Packaging mechanical data

### DPAK FOOTPRINT



### TAPE AND REEL SHIPMENT

40 mm min. Access hole at slot location

Full radius

Tape slot in core for tape start 2.5mm min. width

G measured at hub

DIM.	mm		inch	
	MIN.	MAX.	MIN.	MAX.
A		330		12.992
B	1.5		0.059	
C	12.8	13.2	0.504	0.520
D	20.2		0.795	
G	16.4	18.4	0.645	0.724
N	50		1.968	
T		22.4		0.881

BASE QTY	BULK QTY
2500	2500

DIM.	mm		inch	
	MIN.	MAX.	MIN.	MAX.
A0	6.8	7	0.267	0.275
B0	10.4	10.6	0.409	0.417
B1		12.1		0.476
D	1.5	1.6	0.059	0.063
D1	1.5		0.059	
E	1.65	1.85	0.065	0.073
F	7.4	7.6	0.291	0.299
K0	2.55	2.75	0.100	0.108
P0	3.9	4.1	0.153	0.161
P1	7.9	8.1	0.311	0.319
P2	1.9	2.1	0.075	0.082
R	40		1.574	
W	15.7	16.3	0.618	0.641

TOP COVER TAPE

10 pitches cumulative tolerance on tape +/- 0.2 mm

Center line of cavity

User Direction of Feed

Bending radius R min.

FEED DIRECTION

For machine ref. only including draft and radii concentric around B0

**D<sup>2</sup>PAK FOOTPRINT**

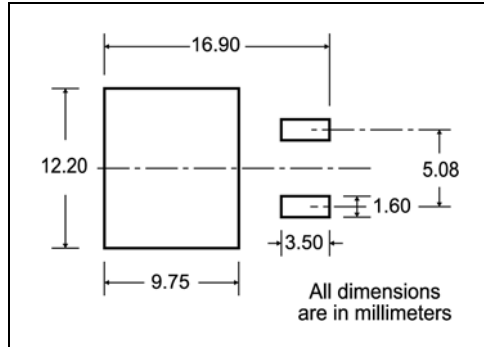

**TAPE AND REEL SHIPMENT**

40 mm min. Access hole at slot location

Full radius

Tape slot in core for tape start 2.5mm min. width

**TAPE MECHANICAL DATA**

DIM.	mm		inch	
	MIN.	MAX.	MIN.	MAX.
A0	10.5	10.7	0.413	0.421
B0	15.7	15.9	0.618	0.626
D	1.5	1.6	0.059	0.063
D1	1.59	1.61	0.062	0.063
E	1.65	1.85	0.065	0.073
F	11.4	11.6	0.449	0.456
K0	4.8	5.0	0.189	0.197
P0	3.9	4.1	0.153	0.161
P1	11.9	12.1	0.468	0.476
P2	1.9	2.1	0.075	0.082
R	50		1.574	
T	0.25	0.35	0.0098	0.0137
W	23.7	24.3	0.933	0.956

**REEL MECHANICAL DATA**

DIM.	mm		inch	
	MIN.	MAX.	MIN.	MAX.
A		330		12.992
B	1.5		0.059	
C	12.8	13.2	0.504	0.520
D	20.2		0.795	
G	24.4	26.4	0.960	1.039
N	100		3.937	
T		30.4		1.197

BASE QTY	BULK QTY
1000	1000

10 pitches cumulative tolerance on tape +/- 0.2 mm

Center line of cavity

User Direction of Feed

FEED DIRECTION

Bending radius R min.

\* on sales type

## 6 Revision history

Table 7. Revision history

Date	Revision	Changes
12-Jul-2006	1	New release

**Please Read Carefully:**

Information in this document is provided solely in connection with ST products. STMicroelectronics NV and its subsidiaries ("ST") reserve the right to make changes, corrections, modifications or improvements, to this document, and the products and services described herein at any time, without notice.

All ST products are sold pursuant to ST's terms and conditions of sale.

Purchasers are solely responsible for the choice, selection and use of the ST products and services described herein, and ST assumes no liability whatsoever relating to the choice, selection or use of the ST products and services described herein.

No license, express or implied, by estoppel or otherwise, to any intellectual property rights is granted under this document. If any part of this document refers to any third party products or services it shall not be deemed a license grant by ST for the use of such third party products or services, or any intellectual property contained therein or considered as a warranty covering the use in any manner whatsoever of such third party products or services or any intellectual property contained therein.

**UNLESS OTHERWISE SET FORTH IN ST'S TERMS AND CONDITIONS OF SALE ST DISCLAIMS ANY EXPRESS OR IMPLIED WARRANTY WITH RESPECT TO THE USE AND/OR SALE OF ST PRODUCTS INCLUDING WITHOUT LIMITATION IMPLIED WARRANTIES OF MERCHANTABILITY, FITNESS FOR A PARTICULAR PURPOSE (AND THEIR EQUIVALENTS UNDER THE LAWS OF ANY JURISDICTION), OR INFRINGEMENT OF ANY PATENT, COPYRIGHT OR OTHER INTELLECTUAL PROPERTY RIGHT.**

**UNLESS EXPRESSLY APPROVED IN WRITING BY AN AUTHORIZED ST REPRESENTATIVE, ST PRODUCTS ARE NOT RECOMMENDED, AUTHORIZED OR WARRANTED FOR USE IN MILITARY, AIR CRAFT, SPACE, LIFE SAVING, OR LIFE SUSTAINING APPLICATIONS, NOR IN PRODUCTS OR SYSTEMS WHERE FAILURE OR MALFUNCTION MAY RESULT IN PERSONAL INJURY, DEATH, OR SEVERE PROPERTY OR ENVIRONMENTAL DAMAGE. ST PRODUCTS WHICH ARE NOT SPECIFIED AS "AUTOMOTIVE GRADE" MAY ONLY BE USED IN AUTOMOTIVE APPLICATIONS AT USER'S OWN RISK.**

Resale of ST products with provisions different from the statements and/or technical features set forth in this document shall immediately void any warranty granted by ST for the ST product or service described herein and shall not create or extend in any manner whatsoever, any liability of ST.

ST and the ST logo are trademarks or registered trademarks of ST in various countries.

Information in this document supersedes and replaces all information previously supplied.

The ST logo is a registered trademark of STMicroelectronics. All other names are the property of their respective owners.

© 2006 STMicroelectronics - All rights reserved

STMicroelectronics group of companies

Australia - Belgium - Brazil - Canada - China - Czech Republic - Finland - France - Germany - Hong Kong - India - Israel - Italy - Japan - Malaysia - Malta - Morocco - Singapore - Spain - Sweden - Switzerland - United Kingdom - United States of America

[www.st.com](http://www.st.com)



## X-ON Electronics

Largest Supplier of Electrical and Electronic Components

*Click to view similar products for [IGBT Transistors](#) category:*

*Click to view products by [STMicroelectronics](#) manufacturer:*

Other Similar products are found below :

[748152A](#) [APT20GT60BRDQ1G](#) [APT50GT60BRG](#) [NGTB10N60FG](#) [STGFW20V60DF](#) [APT30GP60BG](#) [APT45GR65B2DU30](#)  
[GT50JR22\(STA1ES\)](#) [TIG058E8-TL-H](#) [VS-CPV364M4KPBF](#) [NGTB25N120FL2WAG](#) [NGTG40N120FL2WG](#) [RJH60F3DPQ-A0#T0](#)  
[APT40GR120B2SCD10](#) [APT15GT120BRG](#) [APT20GT60BRG](#) [NGTB75N65FL2WAG](#) [NGTG15N120FL2WG](#) [IXA30RG1200DHGLB](#)  
[IXA40RG1200DHGLB](#) [APT70GR65B2DU40](#) [NTE3320](#) [IHF40N65R5SXXSA1](#) [APT70GR120J](#) [APT35GP120JDQ2](#)  
[IKZA40N65RH5XKSA1](#) [IKFW75N65ES5XKSA1](#) [IKFW50N65ES5XKSA1](#) [IKFW50N65EH5XKSA1](#) [IKFW40N65ES5XKSA1](#)  
[IKFW60N65ES5XKSA1](#) [IMBG120R090M1HXTMA1](#) [IMBG120R220M1HXTMA1](#) [XD15H120CX1](#) [XD25H120CX0](#) [XP15PJS120CL1B1](#)  
[IGW30N60H3FKSA1](#) [STGWA8M120DF3](#) [IGW08T120FKSA1](#) [IGW75N60H3FKSA1](#) [HGTG40N60B3](#) [FGH60N60SMD\\_F085](#)  
[FGH75T65UPD](#) [STGWA15H120F2](#) [IKA10N60TXKSA1](#) [IHW20N120R5XKSA1](#) [RJH60D2DPP-M0#T2](#) [IKP20N60TXKSA1](#)  
[IHW20N65R5XKSA1](#) [IDW40E65D2FKSA1](#)