

Trench gate field-stop IGBT, V series 600 V, 20 A very high speed

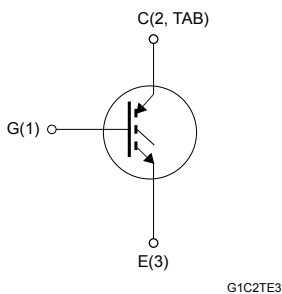
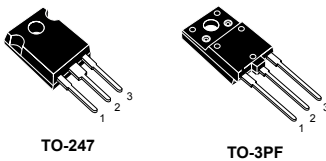

Features

- Maximum junction temperature: $T_J = 175\text{ }^\circ\text{C}$
- Tail-less switching off
- $V_{CE(sat)} = 1.8\text{ V (typ.) @ } I_C = 20\text{ A}$
- Tight parameter distribution
- Safe paralleling
- Low thermal resistance

Applications

- Photovoltaic inverters
- Uninterruptible power supply
- Welding
- Power factor correction
- Very high frequency converters

Description

This device is an IGBT developed using an advanced proprietary trench gate field-stop structure. The device is part of the V series IGBTs, which represent an optimum compromise between conduction and switching losses to maximize the efficiency of very high frequency converters. Furthermore, the positive $V_{CE(sat)}$ temperature coefficient and very tight parameter distribution result in safer paralleling operation.

Product status links

[STGFW20V60F](#)
[STGW20V60F](#)

Product summary

Order code	STGFW20V60F
Marking	GFW20V60F
Package	TO-3PF
Packing	Tube
Order code	STGW20V60F
Marking	GW20V60F
Package	TO-247
Packing	Tube

1 Electrical ratings

Table 1. Absolute maximum ratings

Symbol	Parameter	Value		Unit
		TO-247	TO-3PF	
V_{CES}	Collector-emitter voltage ($V_{GE} = 0\text{ V}$)	600		V
I_C	Continuous collector current at $T_C = 25\text{ °C}$	40	40 ⁽¹⁾	A
	Continuous collector current at $T_C = 100\text{ °C}$	20	20 ⁽¹⁾	
$I_{CP}^{(2)}$	Pulsed collector current	80		A
V_{GE}	Gate-emitter voltage	±20		V
P_{TOT}	Total power dissipation at $T_C = 25\text{ °C}$	167	86.7	W
V_{ISO}	Insulation withstand voltage (RMS) from all three leads to external heat sink ($t = 1\text{ s}$, $T_C = 25\text{ °C}$)		3.5	kV
T_{STG}	Storage temperature range	- 55 to 150		°C
T_J	Operating junction temperature range	- 55 to 175		

1. Limited by maximum junction temperature.

2. Pulse width limited by maximum junction temperature.

Table 2. Thermal data

Symbol	Parameter	Value		Unit
		TO-247	TO-3PF	
R_{thJC}	Thermal resistance, junction-to-case	0.90	1.73	°C/W
R_{thJA}	Thermal resistance, junction-to-ambient	50		°C/W

2 Electrical characteristics

$T_J = 25\text{ °C}$ unless otherwise specified.

Table 3. Static characteristics

Symbol	Parameter	Test conditions	Min.	Typ.	Max.	Unit
$V_{(BR)CES}$	Collector-emitter breakdown voltage	$V_{GE} = 0\text{ V}$, $I_C = 2\text{ mA}$	600			V
$V_{CE(sat)}$	Collector-emitter saturation voltage	$V_{GE} = 15\text{ V}$, $I_C = 20\text{ A}$		1.8	2.2	V
		$V_{GE} = 15\text{ V}$, $I_C = 20\text{ A}$, $T_J = 125\text{ °C}$		2.15		
		$V_{GE} = 15\text{ V}$, $I_C = 20\text{ A}$, $T_J = 175\text{ °C}$		2.3		
$V_{GE(th)}$	Gate threshold voltage	$V_{CE} = V_{GE}$, $I_C = 1\text{ mA}$	5	6	7	V
I_{CES}	Collector cut-off current	$V_{GE} = 0\text{ V}$, $V_{CE} = 600\text{ V}$			25	μA
I_{GES}	Gate-emitter leakage current	$V_{CE} = 0\text{ V}$, $V_{GE} = \pm 20\text{ V}$			250	μA

Table 4. Dynamic characteristics

Symbol	Parameter	Test conditions	Min.	Typ.	Max.	Unit
C_{ies}	Input capacitance	$V_{CE} = 25\text{ V}$, $f = 1\text{ MHz}$, $V_{GE} = 0\text{ V}$	-	2800	-	pF
C_{oes}	Output capacitance		-	110	-	pF
C_{res}	Reverse transfer capacitance		-	64	-	pF
Q_g	Total gate charge	$V_{CC} = 480\text{ V}$, $I_C = 20\text{ A}$, $V_{GE} = 0\text{ to }15\text{ V}$ (see Figure 25. Gate charge test circuit)	-	116	-	nC
Q_{ge}	Gate-emitter charge		-	24	-	nC
Q_{gc}	Gate-collector charge		-	50	-	nC

Table 5. IGBT switching characteristics (inductive load)

Symbol	Parameter	Test conditions	Min.	Typ.	Max.	Unit
$t_{d(on)}$	Turn-on delay time	$V_{CE} = 400\text{ V}$, $I_C = 20\text{ A}$, $R_G = 10\ \Omega$, $V_{GE} = 15\text{ V}$ (see Figure 24. Test circuit for inductive load switching)	-	38	-	ns
t_r	Current rise time		-	10	-	ns
$(di/dt)_{on}$	Turn-on current slope		-	1556	-	A/ μ s
$t_{d(off)}$	Turn-off-delay time		-	149	-	ns
t_f	Current fall time		-	15	-	ns
$E_{on}^{(1)}$	Turn-on switching energy		-	200	-	μ J
$E_{off}^{(2)}$	Turn-off switching energy		-	130	-	μ J
E_{ts}	Total switching energy		-	330	-	μ J
$t_{d(on)}$	Turn-on delay time		$V_{CE} = 400\text{ V}$, $I_C = 20\text{ A}$, $R_G = 10\ \Omega$, $V_{GE} = 15\text{ V}$, $T_J = 175\text{ }^\circ\text{C}$ (see Figure 24. Test circuit for inductive load switching)	-	37	-
t_r	Current rise time	-		12	-	ns
$(di/dt)_{on}$	Turn-on current slope	-		1340	-	A/ μ s
$t_{d(off)}$	Turn-off-delay time	-		150	-	ns
t_f	Current fall time	-		23	-	ns
$E_{on}^{(1)}$	Turn-on switching energy	-		430	-	μ J
$E_{off}^{(2)}$	Turn-off switching energy	-		210	-	μ J
E_{ts}	Total switching energy	-		640	-	μ J

1. Including the reverse recovery of the diode. The diode is the same of the copacked STGW20V60DF.

2. Including the tail of the collector current.

2.1 Electrical characteristics (curves)

Figure 1. Power dissipation vs case temperature for TO-3PF

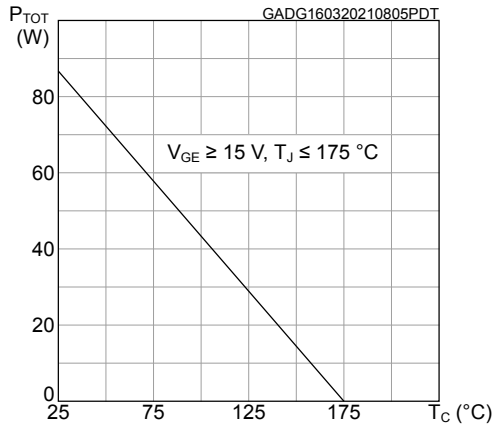

Figure 2. Collector current vs case temperature for TO-3PF

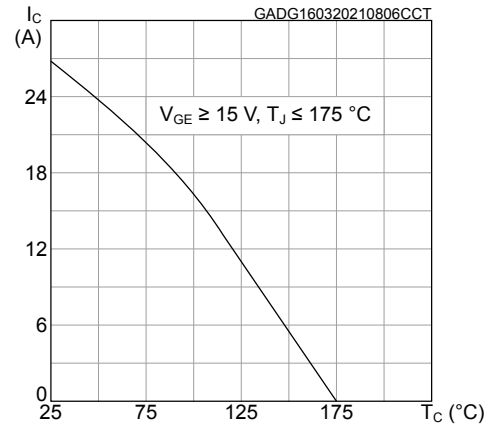

Figure 3. Power dissipation vs case temperature for TO-247

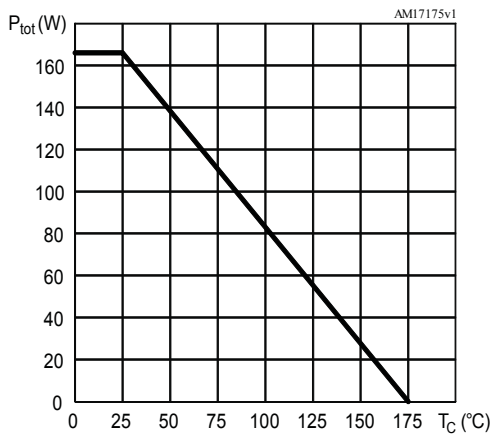

Figure 4. Collector current vs case temperature for TO-247

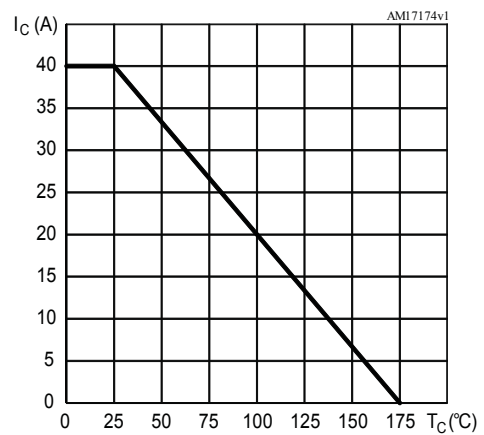

Figure 5. Output characteristics ($T_J = 25$ °C)

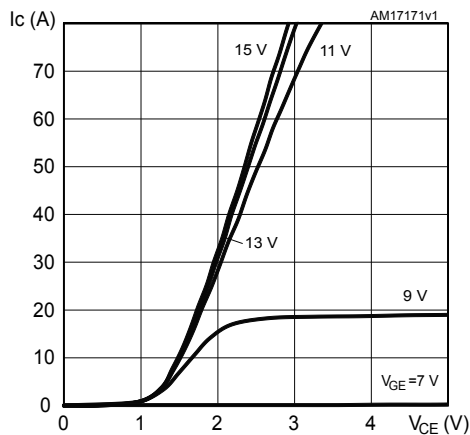

Figure 6. Output characteristics ($T_J = 175$ °C)

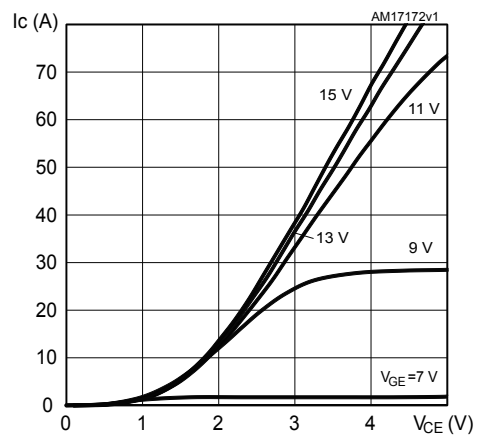

Figure 7. $V_{CE(sat)}$ vs junction temperature

Figure 8. $V_{CE(sat)}$ vs collector current

Figure 9. Safe operating area for TO-3PF

Figure 10. Safe operating area for TO-247

Figure 11. Normalized $V_{GE(th)}$ vs junction temperature

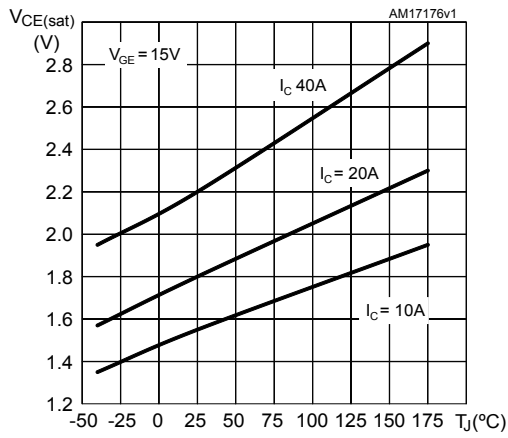
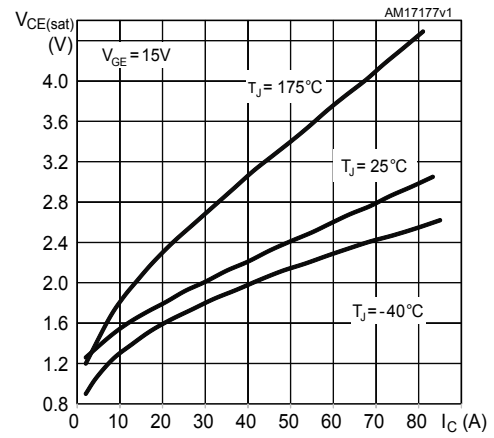
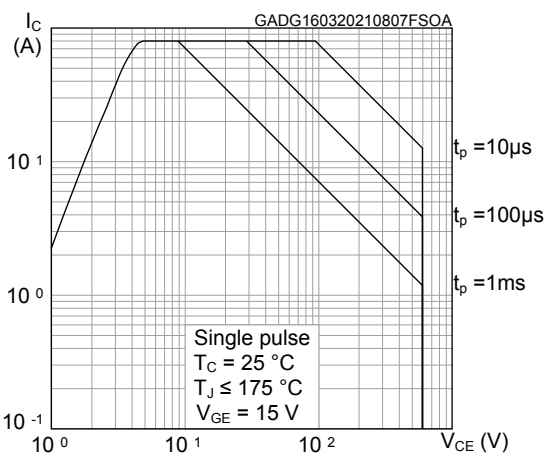
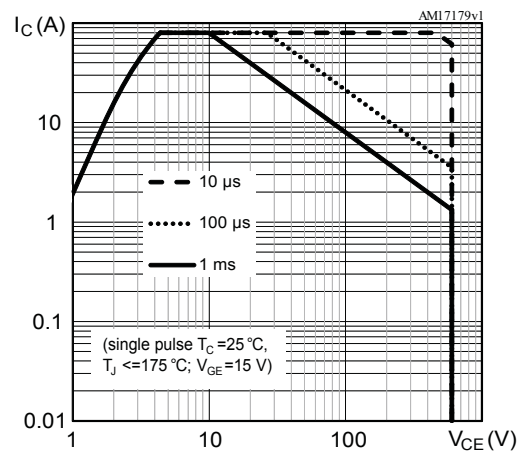
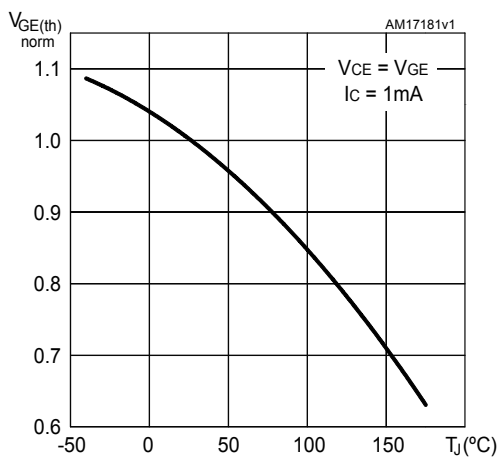
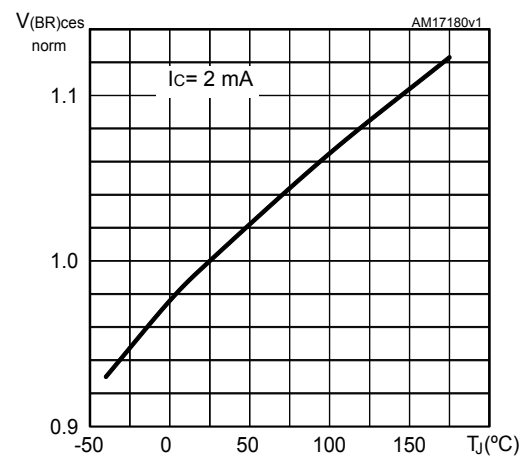
Figure 12. Normalized $V_{(BR)CES}$ vs junction temperature

Figure 13. Capacitance variations

Figure 14. Gate charge vs gate-emitter voltage

Figure 15. Switching energy vs collector current

Figure 16. Switching energy vs gate resistance

Figure 17. Switching energy vs junction temperature

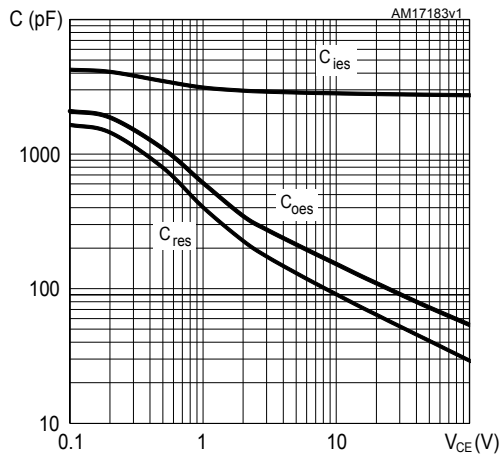
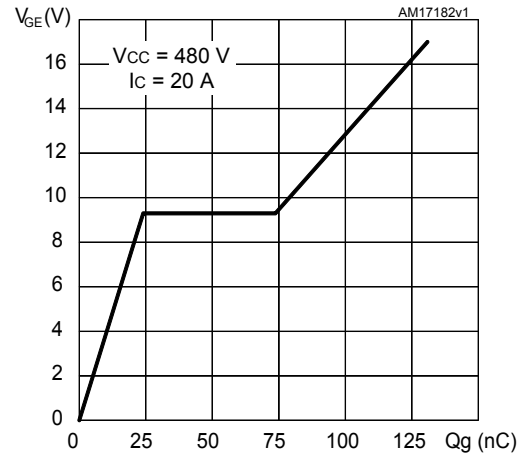
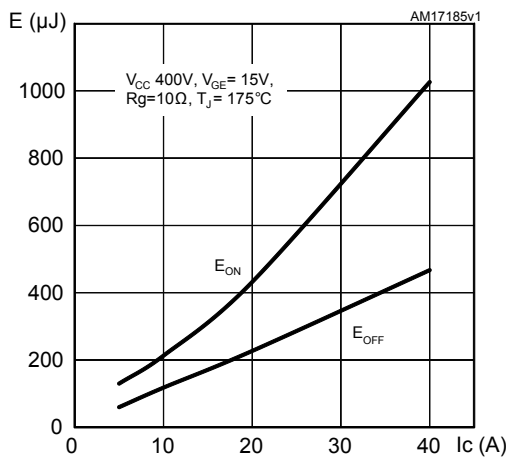
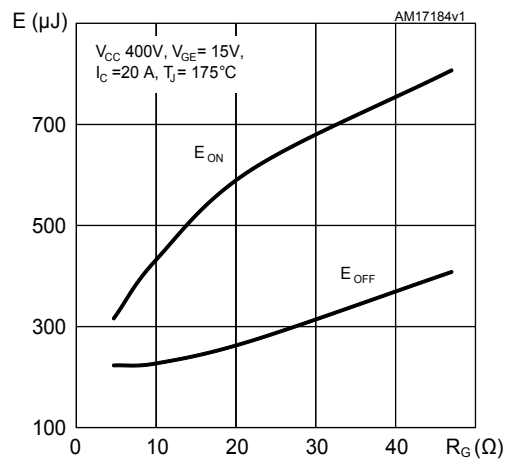
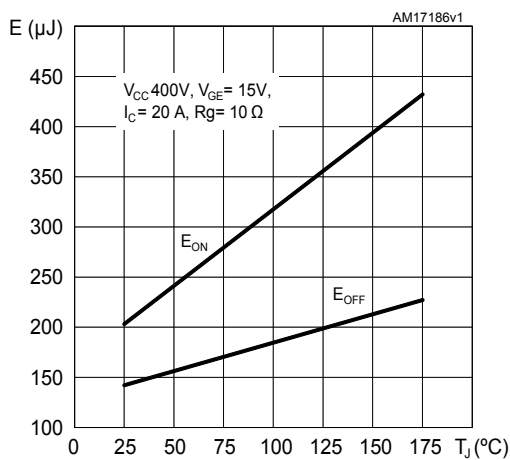
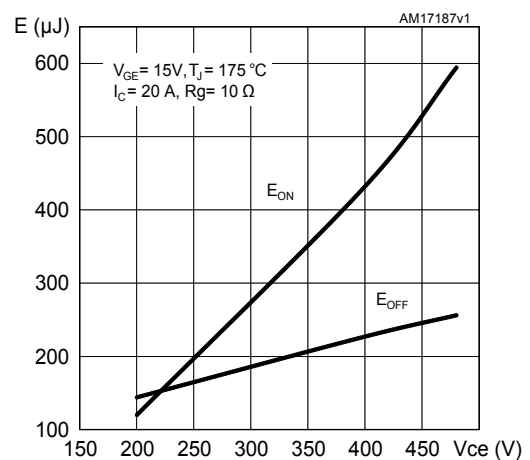
Figure 18. Switching energy vs collector emitter voltage

Figure 19. Switching times vs collector current

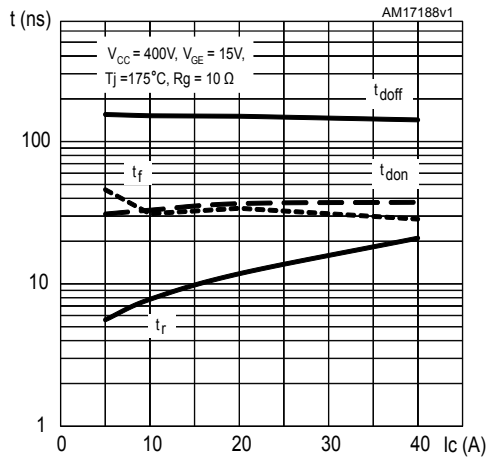

Figure 20. Switching times vs gate resistance

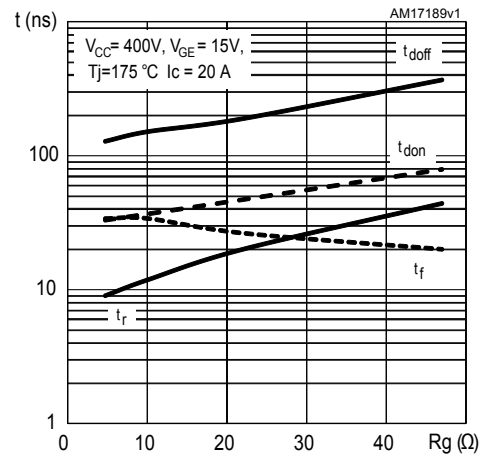

Figure 21. Transfer characteristics

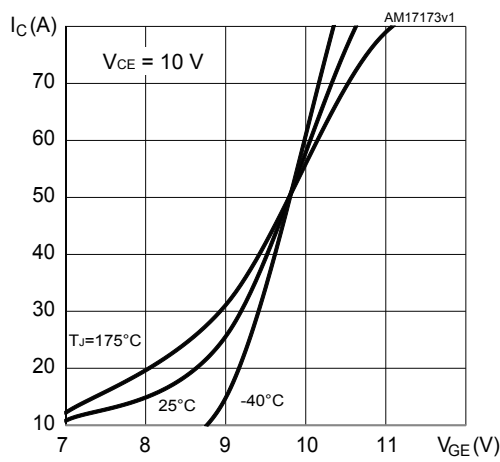

Figure 22. Thermal impedance for TO-3PF

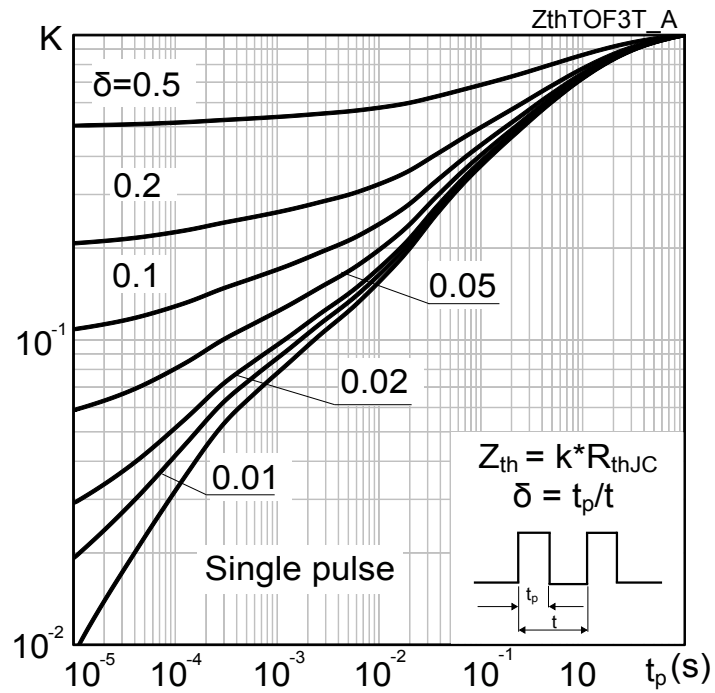
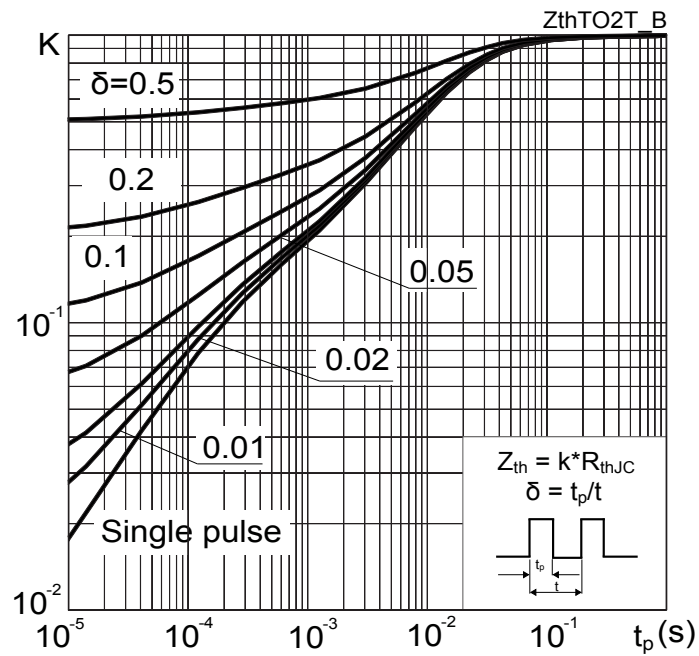
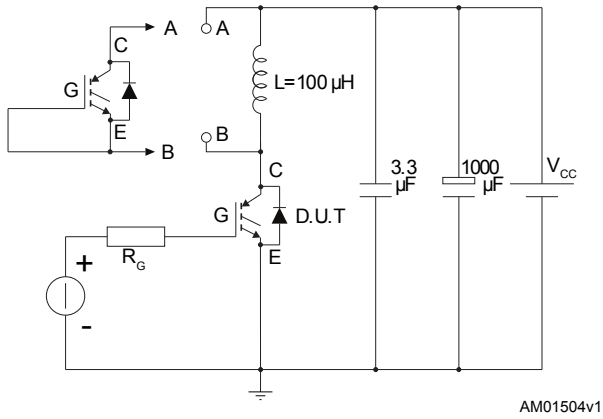
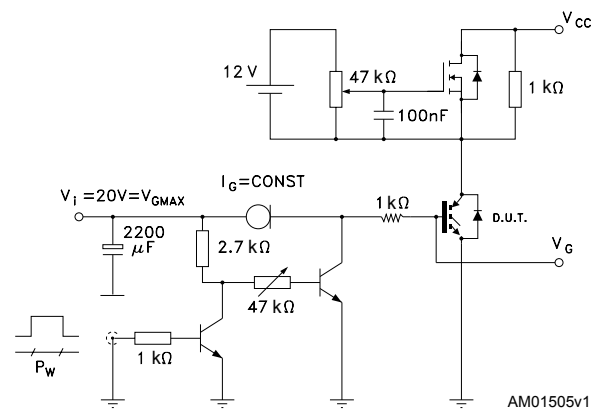
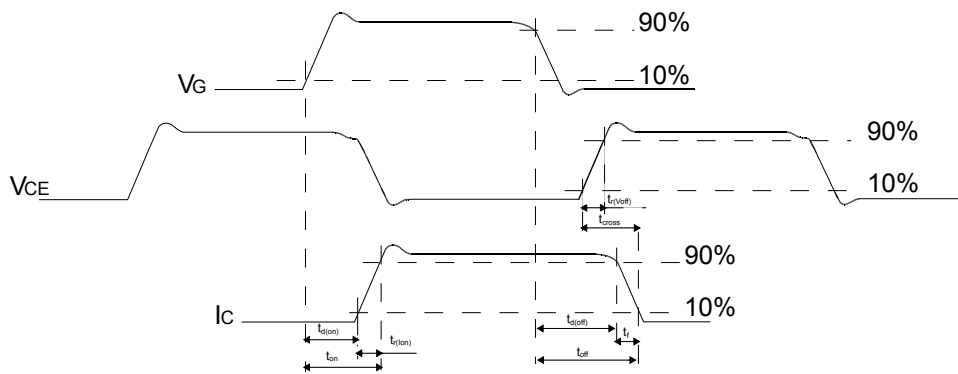

Figure 23. Thermal data for TO-247



3 Test circuits

Figure 24. Test circuit for inductive load switching

Figure 25. Gate charge test circuit

Figure 26. Switching waveform

AM01506v1

4 Package information

In order to meet environmental requirements, ST offers these devices in different grades of **ECOPACK** packages, depending on their level of environmental compliance. ECOPACK specifications, grade definitions and product status are available at: www.st.com. ECOPACK is an ST trademark.

4.1 TO-3PF package information

Figure 27. TO-3PF package outline

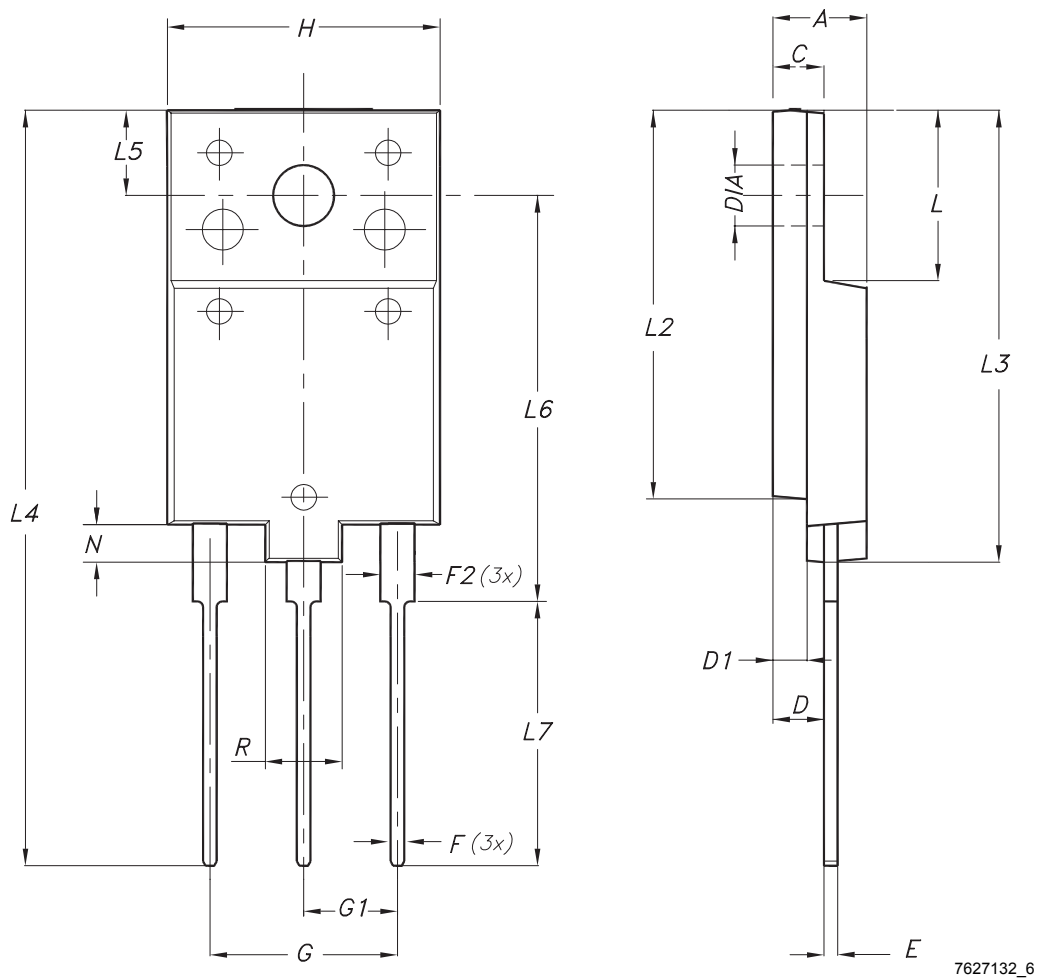

7627132_6

Table 6. TO-3PF mechanical data

Dim.	mm		
	Min.	Typ.	Max.
A	5.30		5.70
C	2.80		3.20
D	3.10		3.50
D1	1.80		2.20
E	0.80		1.10
F	0.65		0.95
F2	1.80		2.20
G	10.30		11.50
G1		5.45	
H	15.30		15.70
L	9.80	10.00	10.20
L2	22.80		23.20
L3	26.30		26.70
L4	43.20		44.40
L5	4.30		4.70
L6	24.30		24.70
L7	14.60		15.00
N	1.80		2.20
R	3.80		4.20
Dia	3.40		3.80

4.2 TO-247 package information

Figure 28. TO-247 package outline

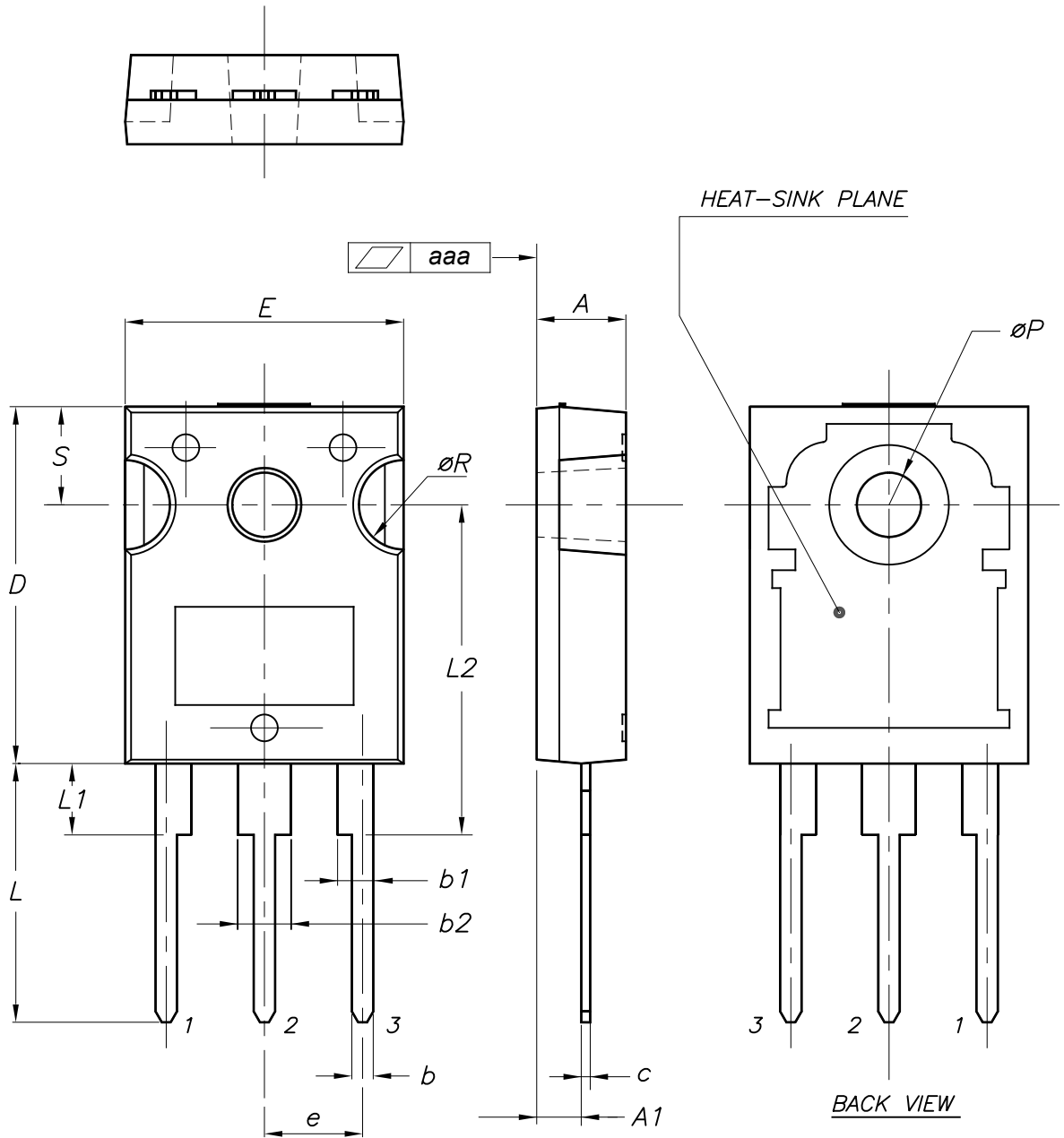

0075325_10

Table 7. TO-247 package mechanical data

Dim.	mm		
	Min.	Typ.	Max.
A	4.85		5.15
A1	2.20		2.60
b	1.0		1.40
b1	2.0		2.40
b2	3.0		3.40
c	0.40		0.80
D	19.85		20.15
E	15.45		15.75
e	5.30	5.45	5.60
L	14.20		14.80
L1	3.70		4.30
L2		18.50	
ØP	3.55		3.65
ØR	4.50		5.50
S	5.30	5.50	5.70
aaa		0.04	0.10

Revision history

Table 8. Document revision history

Date	Version	Changes
11-Jul-2013	1	Initial release.
23-Mar-2021	2	<p>The part number STGWT20V60F have been removed and the document updated accordingly.</p> <p>Updated title and Features in cover page.</p> <p>Updated Section 1 Electrical ratings.</p> <p>Updated Figure 1. Power dissipation vs case temperature for TO-3PF, Figure 2. Collector current vs case temperature for TO-3PF and Figure 9. Safe operating area for TO-3PF.</p> <p>Updated Section 4.2 TO-247 package information.</p> <p>Minor text changes.</p>

Contents

1	Electrical ratings	2
2	Electrical characteristics	3
2.1	Electrical characteristics (curves)	5
3	Test circuits	10
4	Package information	11
4.1	TO-3PF package information	11
4.2	TO-247 package information	13
	Revision history	15

IMPORTANT NOTICE – PLEASE READ CAREFULLY

STMicroelectronics NV and its subsidiaries (“ST”) reserve the right to make changes, corrections, enhancements, modifications, and improvements to ST products and/or to this document at any time without notice. Purchasers should obtain the latest relevant information on ST products before placing orders. ST products are sold pursuant to ST’s terms and conditions of sale in place at the time of order acknowledgement.

Purchasers are solely responsible for the choice, selection, and use of ST products and ST assumes no liability for application assistance or the design of Purchasers’ products.

No license, express or implied, to any intellectual property right is granted by ST herein.

Resale of ST products with provisions different from the information set forth herein shall void any warranty granted by ST for such product.

ST and the ST logo are trademarks of ST. For additional information about ST trademarks, please refer to www.st.com/trademarks. All other product or service names are the property of their respective owners.

Information in this document supersedes and replaces information previously supplied in any prior versions of this document.

© 2021 STMicroelectronics – All rights reserved

X-ON Electronics

Largest Supplier of Electrical and Electronic Components

Click to view similar products for [IGBT Transistors](#) category:

Click to view products by [STMicroelectronics](#) manufacturer:

Other Similar products are found below :

[748152A](#) [APT20GT60BRDQ1G](#) [APT50GT60BRG](#) [NGTB10N60FG](#) [STGFW20V60DF](#) [APT30GP60BG](#) [APT45GR65B2DU30](#)
[GT50JR22\(STA1ES\)](#) [TIG058E8-TL-H](#) [VS-CPV364M4KPBF](#) [NGTB25N120FL2WAG](#) [NGTG40N120FL2WG](#) [RJH60F3DPQ-A0#T0](#)
[APT40GR120B2SCD10](#) [APT15GT120BRG](#) [APT20GT60BRG](#) [NGTB75N65FL2WAG](#) [NGTG15N120FL2WG](#) [IXA30RG1200DHGLB](#)
[IXA40RG1200DHGLB](#) [APT70GR65B2DU40](#) [NTE3320](#) [IHF40N65R5SXXKSA1](#) [APT70GR120J](#) [APT35GP120JDQ2](#)
[IKZA40N65RH5XKSA1](#) [IKFW75N65ES5XKSA1](#) [IKFW50N65ES5XKSA1](#) [IKFW50N65EH5XKSA1](#) [IKFW40N65ES5XKSA1](#)
[IKFW60N65ES5XKSA1](#) [IMBG120R090M1HXTMA1](#) [IMBG120R220M1HXTMA1](#) [XD15H120CX1](#) [XD25H120CX0](#) [XP15PJS120CL1B1](#)
[IGW30N60H3FKSA1](#) [STGWA8M120DF3](#) [IGW08T120FKSA1](#) [IGW75N60H3FKSA1](#) [HGTG40N60B3](#) [FGH60N60SMD_F085](#)
[FGH75T65UPD](#) [STGWA15H120F2](#) [IKA10N60TXKSA1](#) [IHW20N120R5XKSA1](#) [RJH60D2DPP-M0#T2](#) [IKP20N60TXKSA1](#)
[IHW20N65R5XKSA1](#) [IDW40E65D2FKSA1](#)