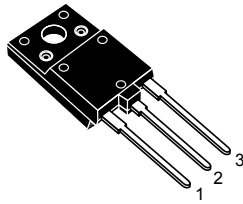
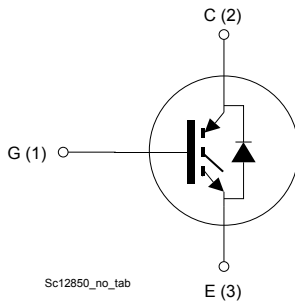


## Trench gate field-stop IGBT, V series 600 V, 30 A very high speed



TO-3PF



### Features

- Maximum junction temperature:  $T_J = 175\text{ °C}$
- Tail-less switching off
- $V_{CE(sat)} = 1.85\text{ V (typ.) @ } I_C = 30\text{ A}$
- Tight parameter distribution
- Safe paralleling
- Low thermal resistance
- Very fast soft recovery antiparallel diode

### Applications

- Photovoltaic inverters
- Uninterruptible power supply
- Welding
- Power factor correction
- Very high frequency converters

### Description

This device is an IGBT developed using an advanced proprietary trench gate field-stop structure. The device is part of the V series IGBTs, which represent an optimum compromise between conduction and switching losses to maximize the efficiency of very high frequency converters. Furthermore, the positive  $V_{CE(sat)}$  temperature coefficient and very tight parameter distribution result in safer paralleling operation.



#### Product status link

[STGFW30V60DF](#)

#### Product summary

<b>Order code</b>	STGFW30V60DF
<b>Marking</b>	G30V60DF
<b>Package</b>	TO-3PF
<b>Packing</b>	Tube

# 1 Electrical ratings

**Table 1. Absolute maximum ratings**

Symbol	Parameter	Value	Unit
$V_{CES}$	Collector-emitter voltage ( $V_{GE} = 0$ V)	600	V
$I_C$	Continuous collector current at $T_C = 25$ °C	60	A
	Continuous collector current at $T_C = 100$ °C	30	
$I_{CP}^{(1)}$	Pulsed collector current	120	A
$V_{GE}$	Gate-emitter voltage	±20	V
$I_F$	Continuous forward current at $T_C = 25$ °C	60	A
	Continuous forward current at $T_C = 100$ °C	30	
$I_{FP}^{(1)}$	Pulsed forward current	120	A
$P_{TOT}$	Total power dissipation at $T_C = 25$ °C	92	W
$V_{ISO}$	Insulation withstand voltage (RMS) from all three leads to external heat sink ( $t = 1$ s, $T_C = 25$ °C)	3.5	kV
$T_{STG}$	Storage temperature range	- 55 to 150	°C
$T_J$	Operating junction temperature range	- 55 to 175	

1. Pulse width limited by maximum junction temperature.

**Table 2. Thermal data**

Symbol	Parameter	Value	Unit
$R_{thJC}$	Thermal resistance, junction-to-case IGBT	1.63	°C/W
	Thermal resistance, junction-to-case diode	2.55	
$R_{thJA}$	Thermal resistance, junction-to-ambient	50	°C/W

## 2 Electrical characteristics

$T_C = 25\text{ °C}$  unless otherwise specified.

**Table 3. Static characteristics**

Symbol	Parameter	Test conditions	Min.	Typ.	Max.	Unit
$V_{(BR)CES}$	Collector-emitter breakdown voltage	$V_{GE} = 0\text{ V}, I_C = 2\text{ mA}$	600			V
$V_{CE(sat)}$	Collector-emitter saturation voltage	$V_{GE} = 15\text{ V}, I_C = 30\text{ A}$		1.85	2.30	V
		$V_{GE} = 15\text{ V}, I_C = 30\text{ A}, T_J = 125\text{ °C}$		2.15		
		$V_{GE} = 15\text{ V}, I_C = 30\text{ A}, T_J = 175\text{ °C}$		2.35		
$V_F$	Forward on-voltage	$I_F = 30\text{ A}$		2.0	2.6	V
		$I_F = 30\text{ A}, T_J = 125\text{ °C}$		1.7		
		$I_F = 30\text{ A}, T_J = 175\text{ °C}$		1.5		
$V_{GE(th)}$	Gate threshold voltage	$V_{CE} = V_{GE}, I_C = 1\text{ mA}$	5	6	7	V
$I_{CES}$	Collector cut-off current	$V_{GE} = 0\text{ V}, V_{CE} = 600\text{ V}$			25	$\mu\text{A}$
$I_{GES}$	Gate-emitter leakage current	$V_{CE} = 0\text{ V}, V_{GE} = \pm 20\text{ V}$			250	nA

**Table 4. Dynamic characteristics**

Symbol	Parameter	Test conditions	Min.	Typ.	Max.	Unit
$C_{ies}$	Input capacitance	$V_{CE} = 25\text{ V}, f = 1\text{ MHz}, V_{GE} = 0\text{ V}$	-	3750	-	pF
$C_{oes}$	Output capacitance		-	120	-	pF
$C_{res}$	Reverse transfer capacitance		-	77	-	pF
$Q_g$	Total gate charge	$V_{CC} = 480\text{ V}, I_C = 30\text{ A}, V_{GE} = 0\text{ to }15\text{ V}$ (see <a href="#">Figure 28. Gate charge test circuit</a> )	-	163	-	nC
$Q_{ge}$	Gate-emitter charge		-	28	-	nC
$Q_{gc}$	Gate-collector charge		-	72	-	nC

**Table 5. IGBT switching characteristics (inductive load)**

Symbol	Parameter	Test conditions	Min.	Typ.	Max.	Unit
$t_{d(on)}$	Turn-on delay time	$V_{CE} = 400\text{ V}$ , $I_C = 30\text{ A}$ , $R_G = 10\ \Omega$ , $V_{GE} = 15\text{ V}$ (see Figure 27. Test circuit for inductive load switching)	-	45	-	ns
$t_r$	Current rise time		-	16	-	ns
$(di/dt)_{on}$	Turn-on current slope		-	1500	-	A/ $\mu$ s
$t_{d(off)}$	Turn-off delay time		-	189	-	ns
$t_f$	Current fall time		-	19	-	ns
$E_{on}^{(1)}$	Turn-on switching energy		-	383	-	$\mu$ J
$E_{off}^{(2)}$	Turn-off switching energy		-	233	-	$\mu$ J
$E_{ts}$	Total switching energy		-	616	-	$\mu$ J
$t_{d(on)}$	Turn-on delay time	$V_{CE} = 400\text{ V}$ , $I_C = 30\text{ A}$ , $R_G = 10\ \Omega$ , $V_{GE} = 15\text{ V}$ , $T_J = 175\text{ }^\circ\text{C}$ (see Figure 27. Test circuit for inductive load switching)	-	42	-	ns
$t_r$	Current rise time		-	17	-	ns
$(di/dt)_{on}$	Turn-on current slope		-	1337	-	A/ $\mu$ s
$t_{d(off)}$	Turn-off delay time		-	193	-	ns
$t_f$	Current fall time		-	32	-	ns
$E_{on}^{(1)}$	Turn-on switching energy		-	794	-	$\mu$ J
$E_{off}^{(2)}$	Turn-off switching energy		-	378	-	$\mu$ J
$E_{ts}$	Total switching energy		-	1172	-	$\mu$ J

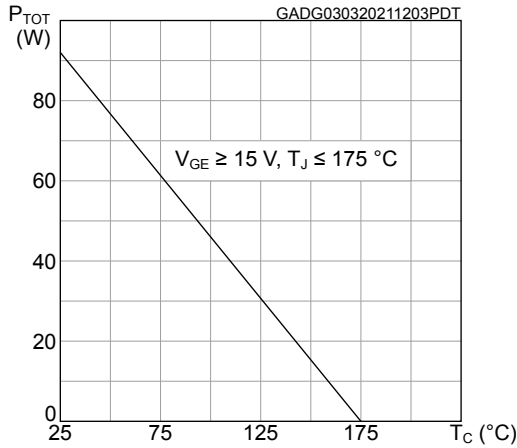
1. Including the reverse recovery of the diode.
2. Including the tail of the collector current.

**Table 6. Diode switching characteristics (inductive load)**

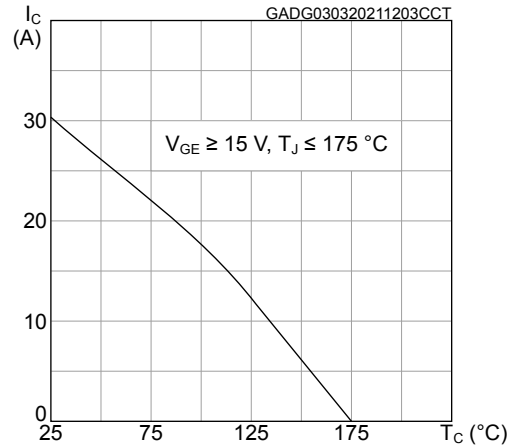
Symbol	Parameter	Test conditions	Min.	Typ.	Max.	Unit
$t_{rr}$	Reverse recovery time	$I_F = 30\text{ A}$ , $V_R = 400\text{ V}$ , $V_{GE} = 15\text{ V}$ , $di/dt = 1000\text{ A}/\mu\text{s}$ (see Figure 27. Test circuit for inductive load switching)	-	53	-	ns
$Q_{rr}$	Reverse recovery charge		-	384	-	nC
$I_{rrm}$	Reverse recovery current		-	14.5	-	A
$dI_{rr}/dt$	Peak rate of fall of reverse recovery current during $t_b$		-	788	-	A/ $\mu$ s
$E_{rr}$	Reverse recovery energy		-	104	-	$\mu$ J
$t_{rr}$	Reverse recovery time	$I_F = 30\text{ A}$ , $V_R = 400\text{ V}$ , $V_{GE} = 15\text{ V}$ , $di/dt = 1000\text{ A}/\mu\text{s}$ , $T_J = 175\text{ }^\circ\text{C}$ (see Figure 27. Test circuit for inductive load switching)	-	104	-	ns
$Q_{rr}$	Reverse recovery charge		-	1352	-	nC
$I_{rrm}$	Reverse recovery current		-	26	-	A
$dI_{rr}/dt$	Peak rate of fall of reverse recovery current during $t_b$		-	310	-	A/ $\mu$ s
$E_{rr}$	Reverse recovery energy		-	407	-	$\mu$ J

## 2.1 Electrical characteristics (curves)

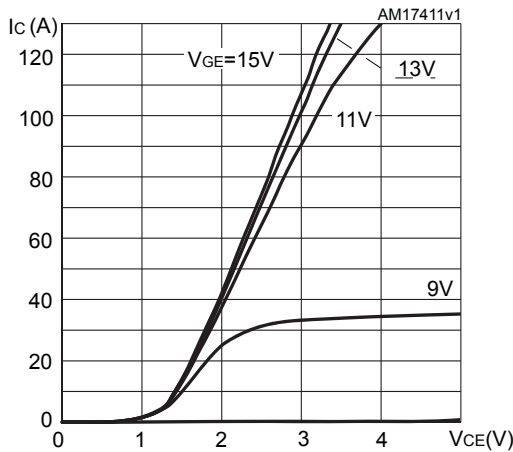
**Figure 1. Power dissipation vs case temperature**



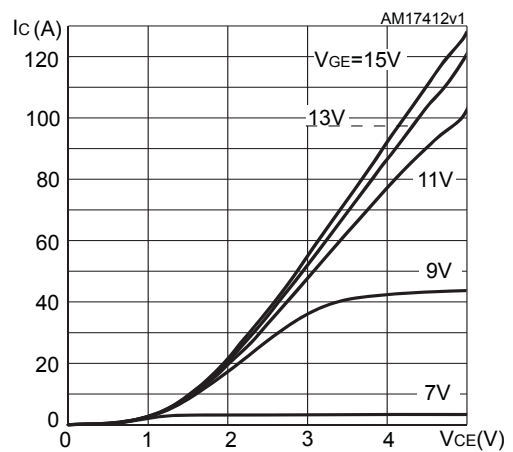
**Figure 2. Collector current vs case temperature**



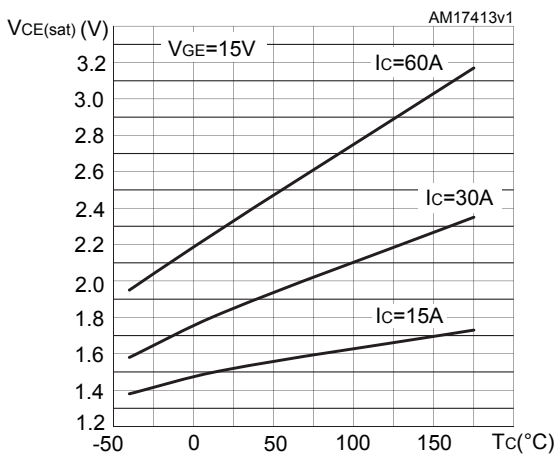
**Figure 3. Output characteristics (T<sub>J</sub> = 25 °C)**



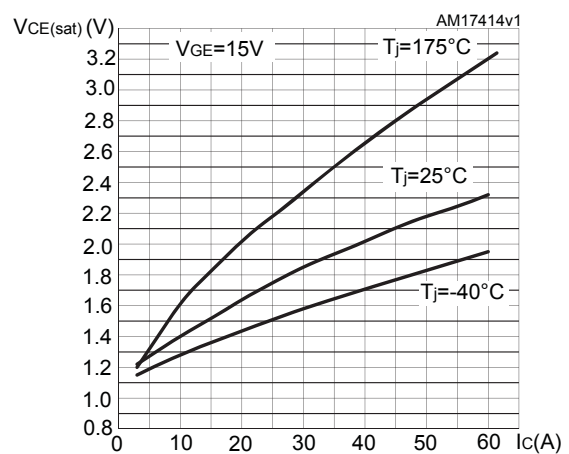
**Figure 4. Output characteristics (T<sub>J</sub> = 175 °C)**



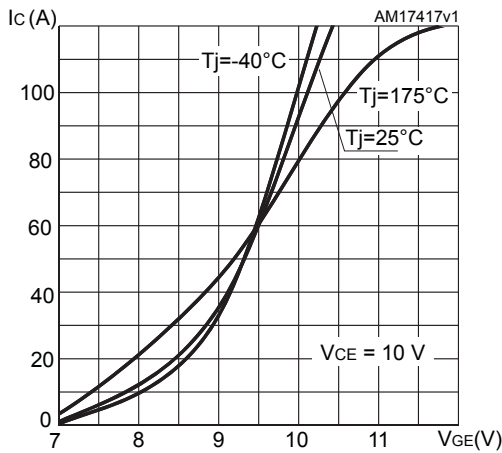
**Figure 5. V<sub>CE(sat)</sub> vs junction temperature**



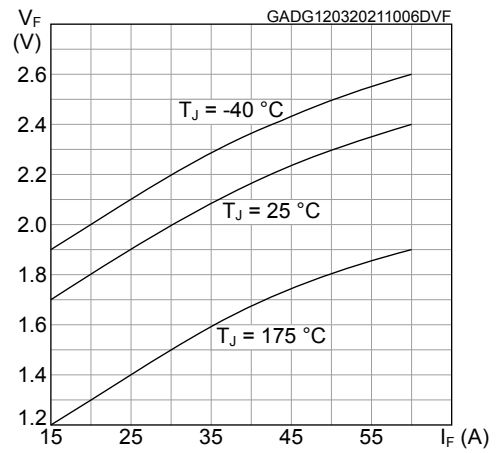
**Figure 6. V<sub>CE(sat)</sub> vs collector current**



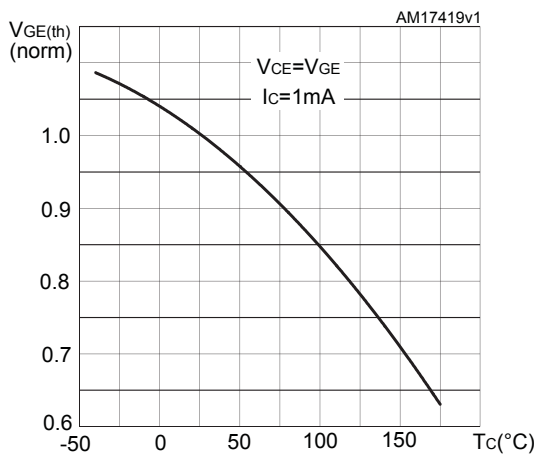
**Figure 7. Transfer characteristics**



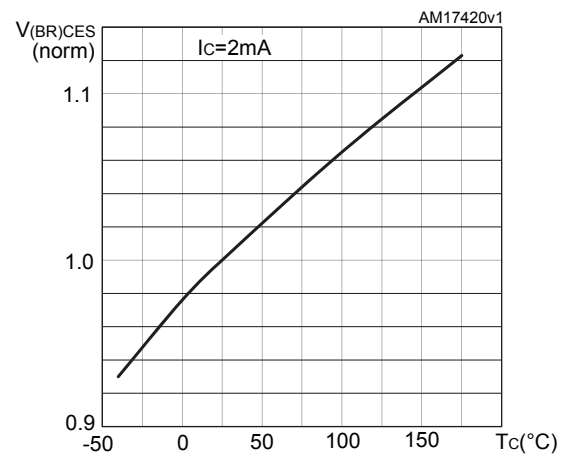
**Figure 8. Diode  $V_F$  vs forward current**



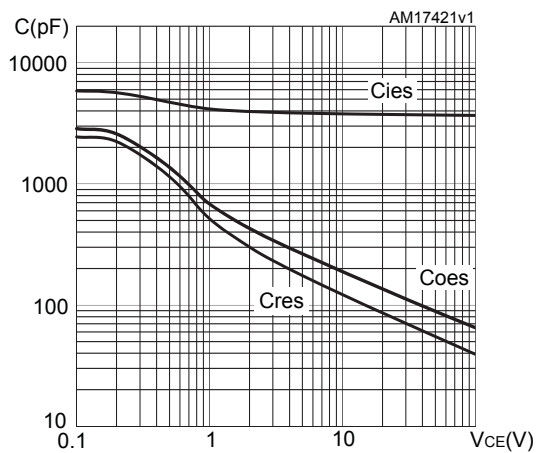
**Figure 9. Normalized  $V_{GE(th)}$  vs junction temperature**



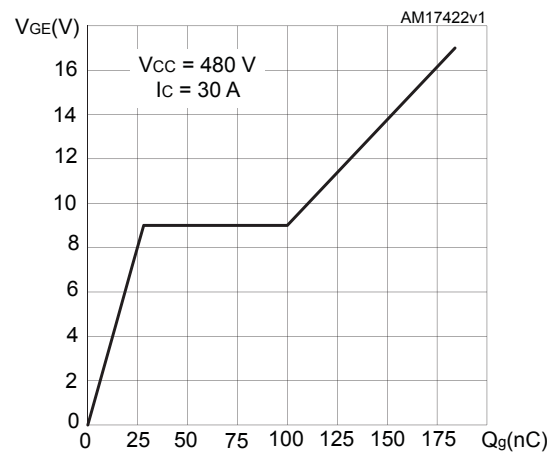
**Figure 10. Normalized  $V_{(BR)CES}$  vs junction temperature**



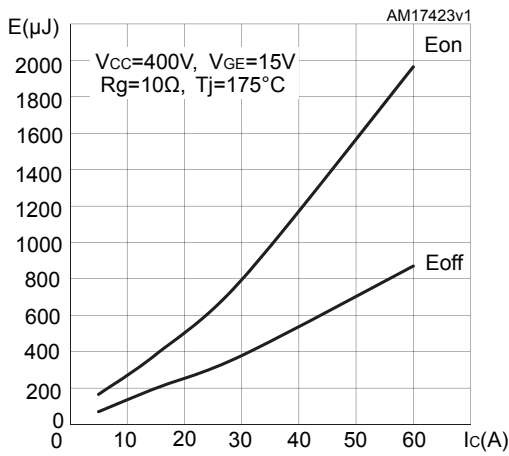
**Figure 11. Capacitance variations**



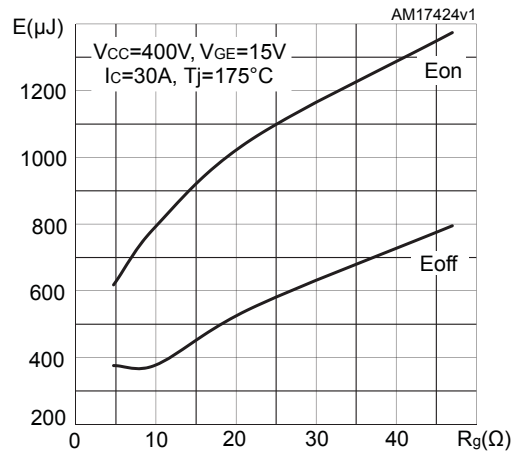
**Figure 12. Gate charge vs gate-emitter voltage**



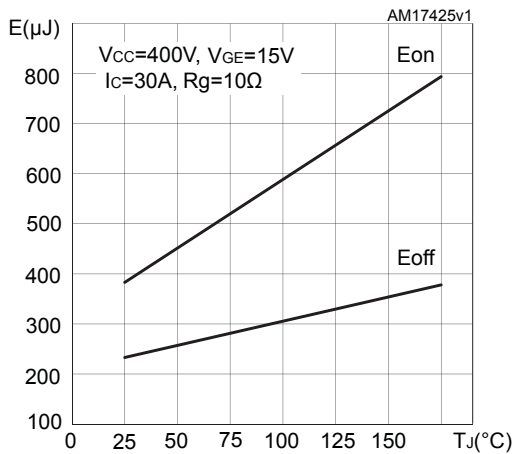
**Figure 13. Switching energy vs collector current**



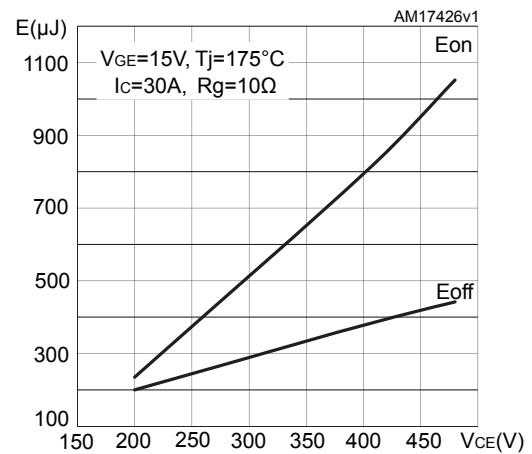
**Figure 14. Switching energy vs gate resistance**



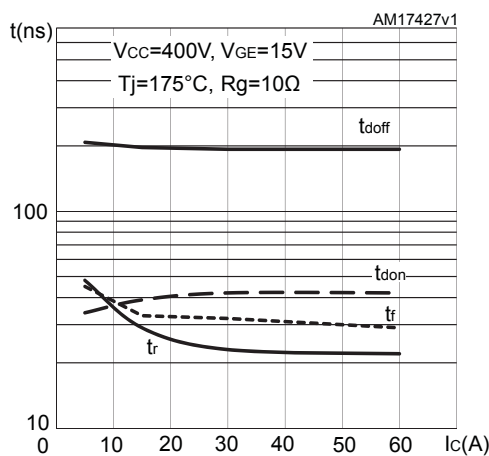
**Figure 15. Switching energy vs junction temperature**



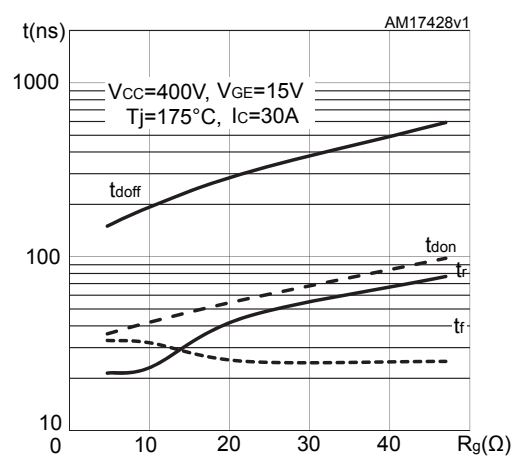
**Figure 16. Switching energy vs collector-emitter voltage**



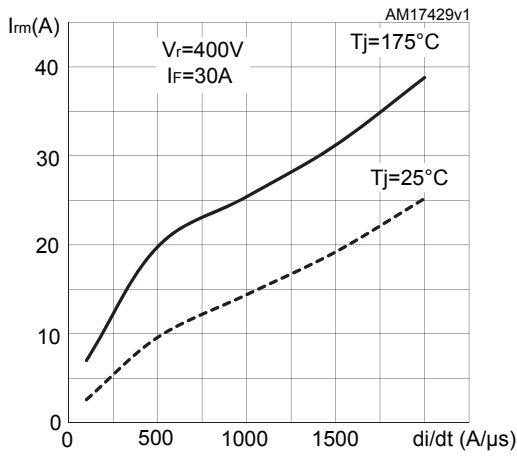
**Figure 17. Switching times vs collector current**



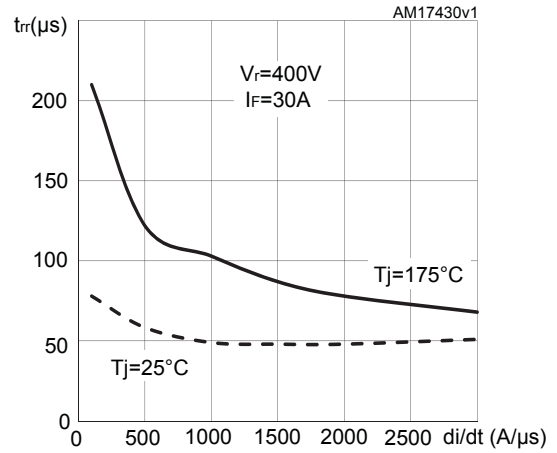
**Figure 18. Switching times vs gate resistance**



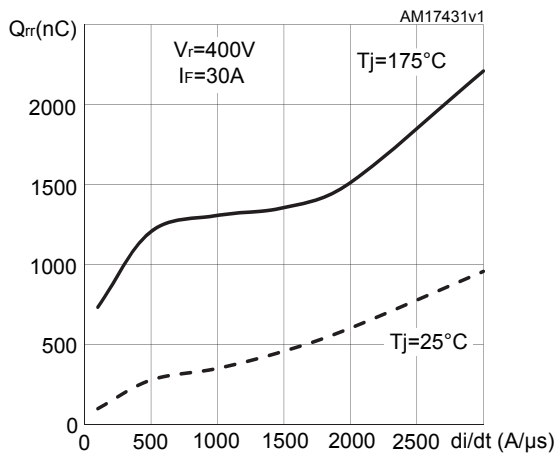
**Figure 19. Reverse recovery current vs diode current slope**



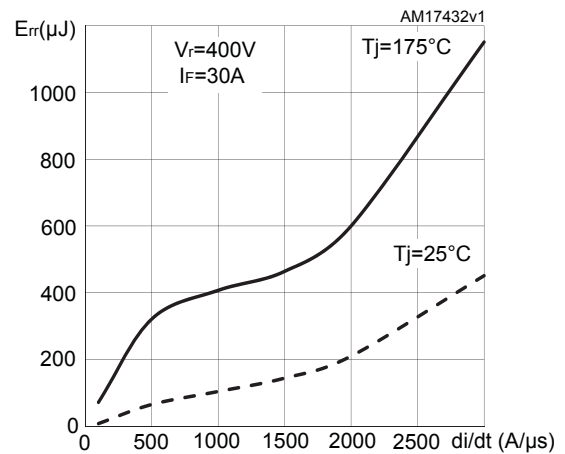
**Figure 20. Reverse recovery time vs diode current slope**



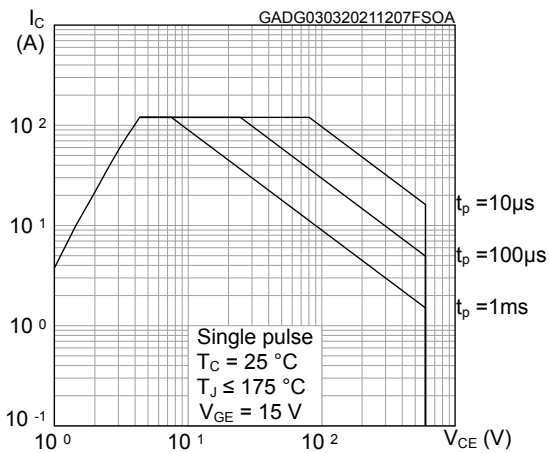
**Figure 21. Reverse recovery charge vs diode current slope**



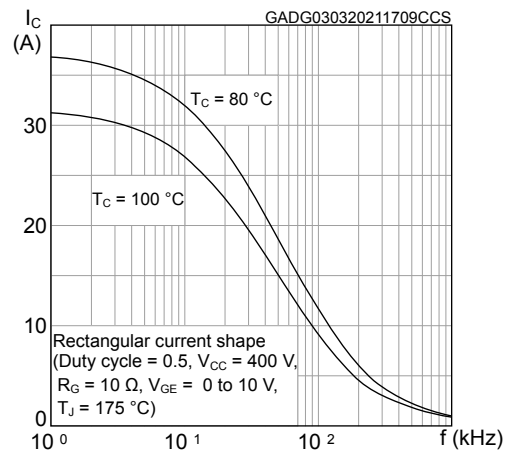
**Figure 22. Reverse recovery energy vs diode current slope**



**Figure 23. Safe operating area**

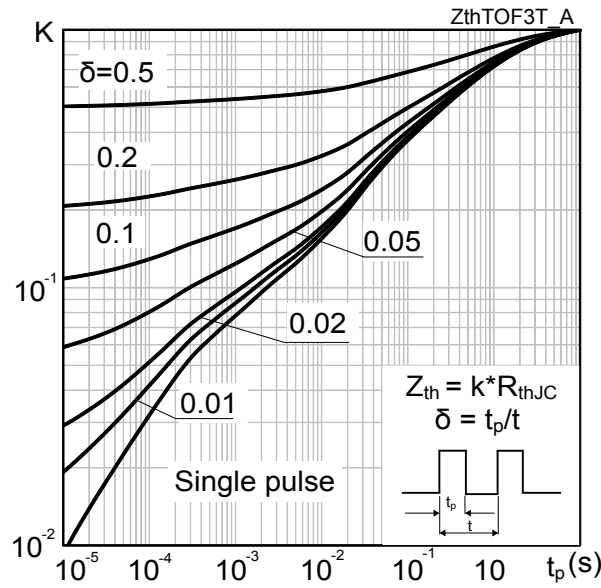


**Figure 24. Collector current vs switching frequency**

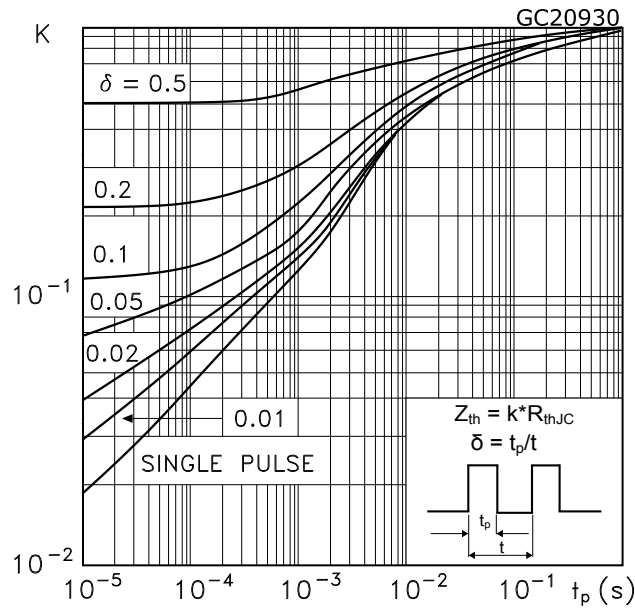




**Figure 25. Thermal impedance for IGBT**



**Figure 26. Thermal impedance for diode**



### 3 Test circuits

Figure 27. Test circuit for inductive load switching

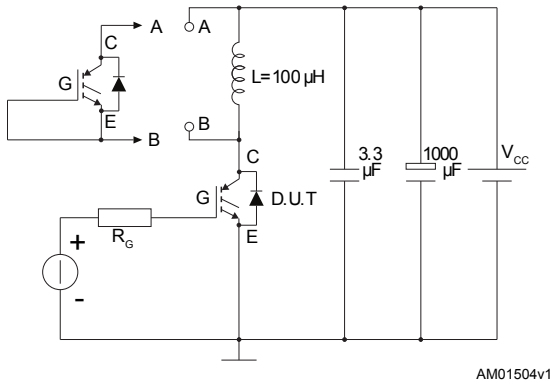


Figure 28. Gate charge test circuit

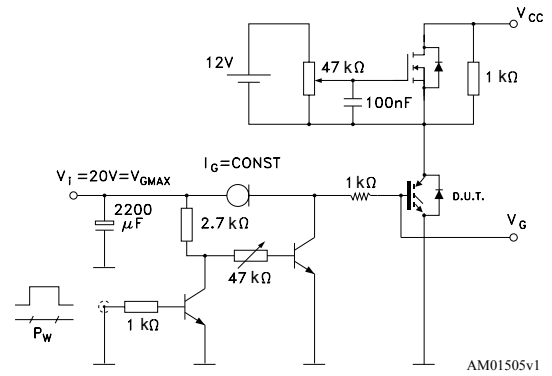


Figure 29. Switching waveform

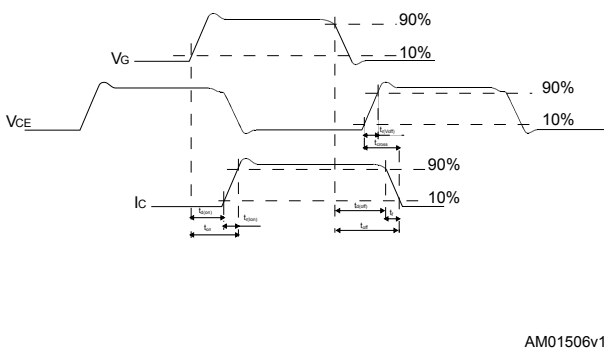
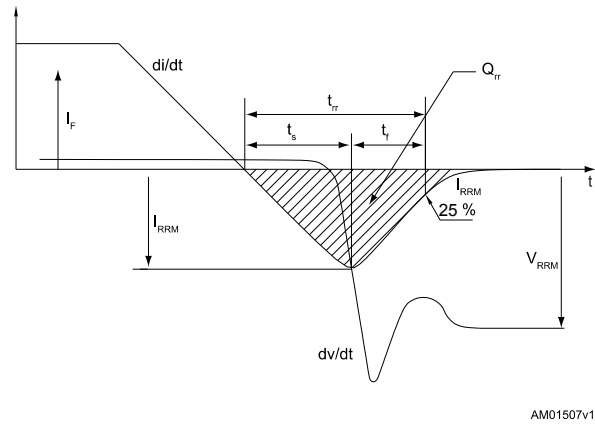


Figure 30. Diode reverse recovery waveform

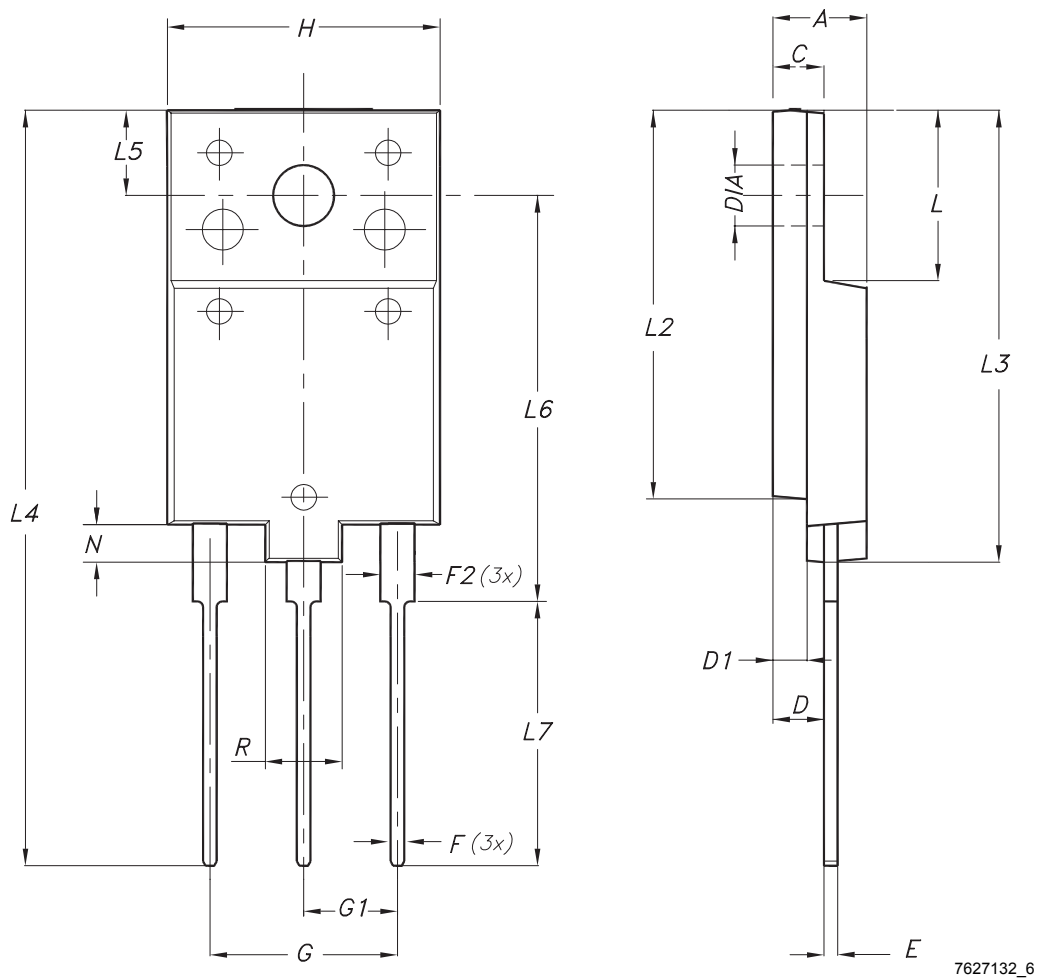


## 4 Package information

In order to meet environmental requirements, ST offers these devices in different grades of **ECOPACK** packages, depending on their level of environmental compliance. ECOPACK specifications, grade definitions and product status are available at: [www.st.com](http://www.st.com). ECOPACK is an ST trademark.

### 4.1 TO-3PF package information

Figure 31. TO-3PF package outline



**Table 7. TO-3PF mechanical data**

Dim.	mm		
	Min.	Typ.	Max.
A	5.30		5.70
C	2.80		3.20
D	3.10		3.50
D1	1.80		2.20
E	0.80		1.10
F	0.65		0.95
F2	1.80		2.20
G	10.30		11.50
G1		5.45	
H	15.30		15.70
L	9.80	10.00	10.20
L2	22.80		23.20
L3	26.30		26.70
L4	43.20		44.40
L5	4.30		4.70
L6	24.30		24.70
L7	14.60		15.00
N	1.80		2.20
R	3.80		4.20
Dia	3.40		3.80

## Revision history

**Table 8. Document revision history**

Date	Revision	Changes
31-Mar-2014	1	Initial release.
14-Apr-2020	2	Updated <i>Section Product status / summary</i> in cover page. Minor text changes.
12-Mar-2021	3	Updated <a href="#">Section 1 Electrical ratings</a> . Updated <a href="#">Table 3. Static characteristics</a> . Updated <a href="#">Figure 1. Power dissipation vs case temperature</a> , <a href="#">Figure 2. Collector current vs case temperature</a> , <a href="#">Figure 8. Diode <math>V_F</math> vs forward current</a> , <a href="#">Figure 23. Safe operating area</a> and added <a href="#">Figure 24. Collector current vs switching frequency</a> . Minor text changes.

---

## Contents

<b>1</b>	<b>Electrical ratings</b> .....	<b>2</b>
<b>2</b>	<b>Electrical characteristics</b> .....	<b>3</b>
<b>2.1</b>	<b>Electrical characteristics (curves)</b> .....	<b>5</b>
<b>3</b>	<b>Test circuits</b> .....	<b>10</b>
<b>4</b>	<b>Package information</b> .....	<b>11</b>
<b>4.1</b>	<b>TO-3PF package information</b> .....	<b>11</b>
	<b>Revision history</b> .....	<b>13</b>

**IMPORTANT NOTICE – PLEASE READ CAREFULLY**

STMicroelectronics NV and its subsidiaries (“ST”) reserve the right to make changes, corrections, enhancements, modifications, and improvements to ST products and/or to this document at any time without notice. Purchasers should obtain the latest relevant information on ST products before placing orders. ST products are sold pursuant to ST’s terms and conditions of sale in place at the time of order acknowledgement.

Purchasers are solely responsible for the choice, selection, and use of ST products and ST assumes no liability for application assistance or the design of Purchasers’ products.

No license, express or implied, to any intellectual property right is granted by ST herein.

Resale of ST products with provisions different from the information set forth herein shall void any warranty granted by ST for such product.

ST and the ST logo are trademarks of ST. For additional information about ST trademarks, please refer to [www.st.com/trademarks](http://www.st.com/trademarks). All other product or service names are the property of their respective owners.

Information in this document supersedes and replaces information previously supplied in any prior versions of this document.

© 2021 STMicroelectronics – All rights reserved

## X-ON Electronics

Largest Supplier of Electrical and Electronic Components

*Click to view similar products for [IGBT Transistors](#) category:*

*Click to view products by [STMicroelectronics](#) manufacturer:*

Other Similar products are found below :

[748152A](#) [APT20GT60BRDQ1G](#) [NGTB10N60FG](#) [STGFW20V60DF](#) [APT30GP60BG](#) [APT45GR65B2DU30](#) [GT50JR22\(STA1ES\)](#)  
[TIG058E8-TL-H](#) [VS-CPV364M4KPBF](#) [NGTB25N120FL2WAG](#) [NGTG40N120FL2WG](#) [RJH60F3DPQ-A0#T0](#) [APT40GR120B2SCD10](#)  
[APT15GT120BRG](#) [APT20GT60BRG](#) [NGTB75N65FL2WAG](#) [NGTG15N120FL2WG](#) [IXA30RG1200DHGLB](#) [IXA40RG1200DHGLB](#)  
[APT70GR65B2DU40](#) [NTE3320](#) [IHFV40N65R5SXKSA1](#) [APT70GR120J](#) [APT35GP120JDQ2](#) [IKZA40N65RH5XKSA1](#)  
[IKFW75N65ES5XKSA1](#) [IKFW50N65ES5XKSA1](#) [IKFW50N65EH5XKSA1](#) [IKFW40N65ES5XKSA1](#) [IKFW60N65ES5XKSA1](#)  
[IMBG120R090M1HXTMA1](#) [IMBG120R220M1HXTMA1](#) [XD15H120CX1](#) [XD25H120CX0](#) [XP15PJS120CL1B1](#) [IGW30N60H3FKSA1](#)  
[STGWA8M120DF3](#) [IGW08T120FKSA1](#) [IGW75N60H3FKSA1](#) [HGTG40N60B3](#) [FGH60N60SMD\\_F085](#) [FGH75T65UPD](#)  
[STGWA15H120F2](#) [IKA10N60TXKSA1](#) [IKW25N120T2FKSA1](#) [IKP20N60TXKSA1](#) [IHW20N65R5XKSA1](#) [IDW40E65D2FKSA1](#)  
[APT70GR120JD60](#) [AOD5B60D](#)