

### Features

- High speed switching
- Tight parameters distribution
- Safe paralleling
- Low thermal resistance
- 6  $\mu$ s short-circuit withstand time
- Ultrafast soft recovery antiparallel diode
- Lead free package

### Applications

- Photovoltaic inverters
- Uninterruptible power supply
- Welding
- Power factor correction
- High switching frequency converters

### Description

Using advanced proprietary trench gate and field stop structure, this IGBT leads to an optimized compromise between conduction and switching losses maximizing the efficiency for high switching frequency converters. Furthermore, a slightly positive  $V_{CE(sat)}$  temperature coefficient and a very tight parameter distribution result in an easier paralleling operation.

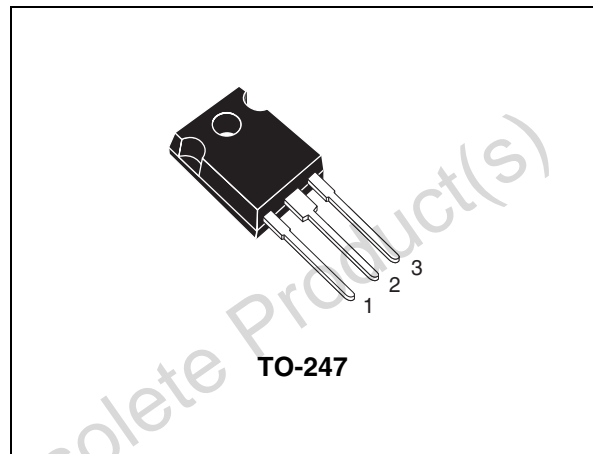

Figure 1. Internal schematic diagram

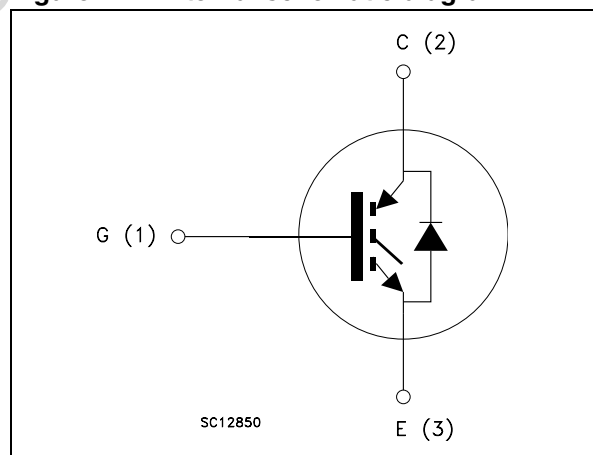

Table 1. Device summary

Order code	Marking	Package	Packaging
STGW50H60DF	GW50H60DF	TO-247	Tube

# 1 Electrical ratings

**Table 2. Absolute maximum ratings**

Symbol	Parameter	Value	Unit
$V_{CES}$	Collector-emitter voltage ( $V_{GE} = 0$ )	600	V
$I_C$	Continuous collector current at $T_C = 25\text{ °C}$	100	A
$I_C$	Continuous collector current at $T_C = 100\text{ °C}$	50	A
$I_{CP}^{(1)}$	Pulsed collector current	200	A
$V_{GE}$	Gate-emitter voltage	$\pm 20$	V
$I_F$	Diode RMS forward current at $T_C = 25\text{ °C}$	30	A
$I_{FSM}$	Surge not repetitive forward current $t_p = 10\text{ ms}$ sinusoidal	120	A
$P_{TOT}$	Total dissipation at $T_C = 25\text{ °C}$	360	W
$t_{SC}$	Short-circuit withstand time at $V_{CC} = 400\text{ V}$ , $V_{GE} = 15\text{ V}$	6	$\mu\text{s}$
$T_{STG}$	Storage temperature range	- 55 to 150	$^{\circ}\text{C}$
$T_J$	Operating junction temperature		

1. Pulse width limited by maximum junction temperature and turn-off within RBSOA

**Table 3. Thermal data**

Symbol	Parameter	Value	Unit
$R_{thJC}$	Thermal resistance junction-case IGBT	0.35	$^{\circ}\text{C/W}$
$R_{thJC}$	Thermal resistance junction-case diode	1.5	$^{\circ}\text{C/W}$
$R_{thJA}$	Thermal resistance junction-ambient	50	$^{\circ}\text{C/W}$

## 2 Electrical characteristics

$T_J = 25\text{ °C}$  unless otherwise specified.

**Table 4. Static**

Symbol	Parameter	Test conditions	Min.	Typ.	Max.	Unit
$V_{(BR)CES}$	Collector-emitter breakdown voltage ( $V_{GE} = 0$ )	$I_C = 2\text{ mA}$	600			V
$V_{CE(sat)}$	Collector-emitter saturation voltage	$V_{GE} = 15\text{ V}, I_C = 50\text{ A}$		1.8		V
		$V_{GE} = 15\text{ V}, I_C = 50\text{ A}$ $T_J = 125\text{ °C}$		2.0		
$V_{GE(th)}$	Gate threshold voltage	$V_{CE} = V_{GE}, I_C = 1\text{ mA}$		6.0		V
$I_{CES}$	Collector cut-off current ( $V_{GE} = 0$ )	$V_{CE} = 600\text{ V}$			25	$\mu\text{A}$
$I_{GES}$	Gate-emitter leakage current ( $V_{CE} = 0$ )	$V_{GE} = \pm 20\text{ V}$			250	nA

**Table 5. Dynamic**

Symbol	Parameter	Test conditions	Min.	Typ.	Max.	Unit
$C_{ies}$	Input capacitance	$V_{CE} = 25\text{ V}, f = 1\text{ MHz},$ $V_{GE} = 0$	-	7150	-	pF
$C_{oes}$	Output capacitance			275		
$C_{res}$	Reverse transfer capacitance			140		
$Q_g$	Total gate charge	$V_{CC} = 400\text{ V}, I_C = 50\text{ A},$ $V_{GE} = 15\text{ V}$	-	217	-	nC
$Q_{ge}$	Gate-emitter charge			61		
$Q_{gc}$	Gate-collector charge			90		

**Table 6. Switching on/off (inductive load)**

Symbol	Parameter	Test conditions	Min.	Typ.	Max.	Unit
$t_{d(on)}$	Turn-on delay time	$V_{CE} = 400\text{ V}, I_C = 50\text{ A},$ $R_G = 10\ \Omega, V_{GE} = 15\text{ V}$	-	62	-	ns
$t_r$	Current rise time			28		
$(di/dt)_{on}$	Turn-on current slope			1800		
$t_{d(on)}$	Turn-on delay time	$V_{CE} = 400\text{ V}, I_C = 50\text{ A},$ $R_G = 10\ \Omega, V_{GE} = 15\text{ V}$ $T_J = 125\text{ °C}$	-	62	-	ns
$t_r$	Current rise time			29		
$(di/dt)_{on}$	Turn-on current slope			1680		
$t_r(V_{off})$	Off voltage rise time	$V_{CE} = 400\text{ V}, I_C = 50\text{ A},$ $R_G = 10\ \Omega, V_{GE} = 15\text{ V}$	-	34	-	ns
$t_{d(off)}$	Turn-off delay time			178		
$t_f$	Current fall time			40		
$t_r(V_{off})$	Off voltage rise time	$V_{CE} = 400\text{ V}, I_C = 50\text{ A},$ $R_G = 10\ \Omega, V_{GE} = 15\text{ V}$ $T_J = 125\text{ °C}$	-	45	-	ns
$t_{d(off)}$	Turn-off delay time			205		
$t_f$	Current fall time			80		

**Table 7. Switching energy (inductive load)**

Symbol	Parameter	Test conditions	Min.	Typ.	Max.	Unit
$E_{on}^{(1)}$	Turn-on switching losses	$V_{CE} = 400\text{ V}, I_C = 50\text{ A},$ $R_G = 10\ \Omega, V_{GE} = 15\text{ V}$	-	0.89	-	mJ
$E_{off}^{(2)}$	Turn-off switching losses			0.86		mJ
$E_{ts}$	Total switching losses			1.75		mJ
$E_{on}^{(1)}$	Turn-on switching losses	$V_{CE} = 400\text{ V}, I_C = 50\text{ A},$ $R_G = 10\ \Omega, V_{GE} = 15\text{ V}$ $T_J = 125\text{ }^\circ\text{C}$	-	1.24	-	mJ
$E_{off}^{(2)}$	Turn-off switching losses			1.15		mJ
$E_{ts}$	Total switching losses			2.39		mJ

- $E_{on}$  is the turn-on losses when a typical diode is used in the test circuit in [Figure 20](#). If the IGBT is offered in a package with a co-pack diode, the co-pack diode is used as external diode. IGBTs and diode are at the same temperature (25 °C and 125 °C).
- Turn-off losses include also the tail of the collector current.

**Table 8. Collector-emitter diode**

Symbol	Parameter	Test conditions	Min.	Typ.	Max.	Unit
$V_F$	Forward on-voltage	$I_F = 30\text{ A}$ $I_F = 30\text{ A}, T_J = 125\text{ }^\circ\text{C}$	-	2 1.65	2.5	V V
$t_{rr}$	Reverse recovery time	$I_F = 30\text{ A}, V_R = 50\text{ V},$ $di/dt = 100\text{ A}/\mu\text{s}$	-	55	-	ns
$Q_{rr}$	Reverse recovery charge			110		nC
$I_{rrm}$	Reverse recovery current			3		A
$t_{rr}$	Reverse recovery time	$I_F = 30\text{ A}, V_R = 50\text{ V},$ $di/dt = 100\text{ A}/\mu\text{s}, T_J = 125\text{ }^\circ\text{C}$	-	140	-	ns
$Q_{rr}$	Reverse recovery charge			400		nC
$I_{rrm}$	Reverse recovery current			5.5		A

## 2.1 Electrical characteristics (curves)

Figure 2. Output characteristics ( $T_J = -40\text{ }^\circ\text{C}$ ) Figure 3. Output characteristics ( $T_J = 25\text{ }^\circ\text{C}$ )

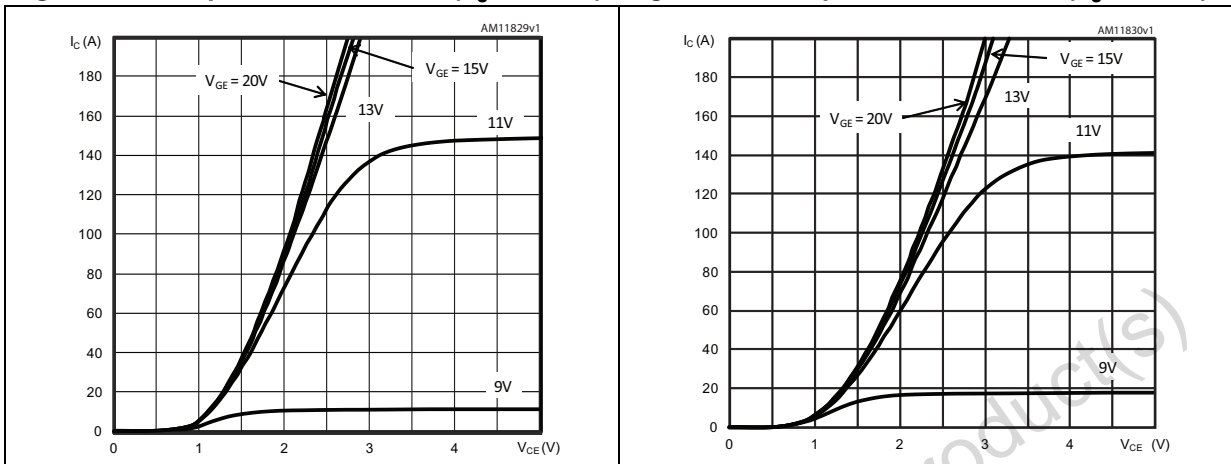

Figure 4. Output characteristics ( $T_J = 150\text{ }^\circ\text{C}$ ) Figure 5. Transfer characteristics

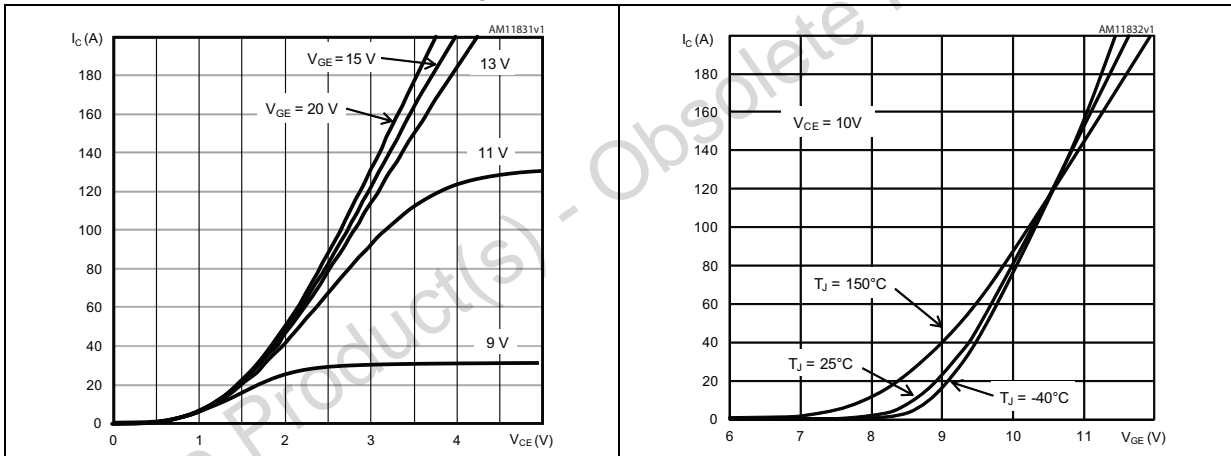

Figure 6.  $V_{CE(SAT)}$  vs. junction temperature

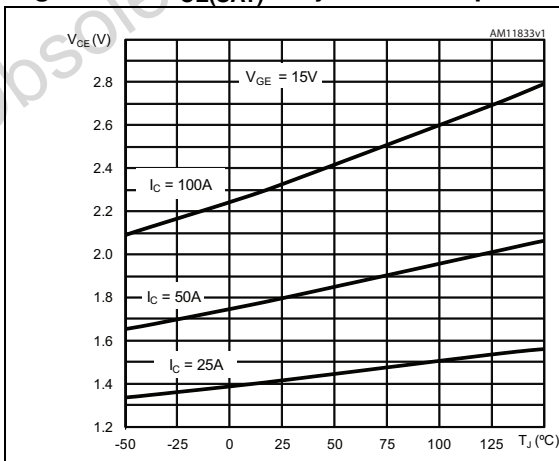

Figure 7.  $V_{CE(SAT)}$  vs. collector current

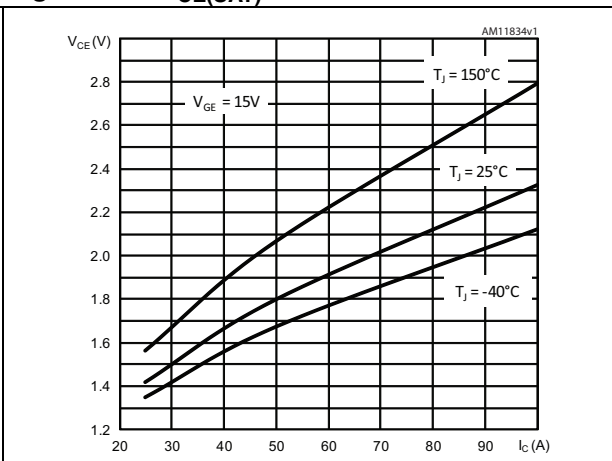

Figure 8. Normalized  $V_{GE(th)}$  vs. junction temperature

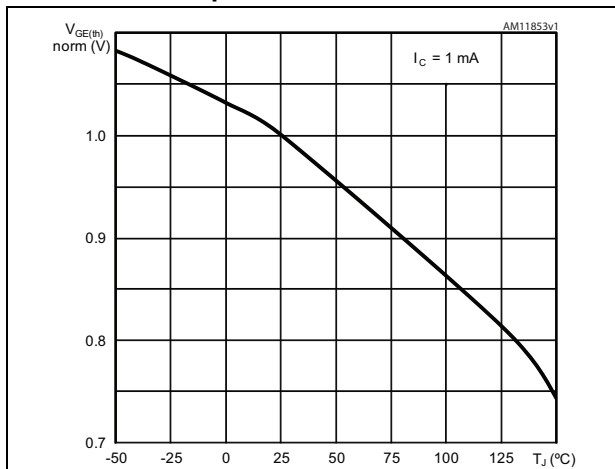

Figure 9. Gate charge vs. gate-emitter voltage

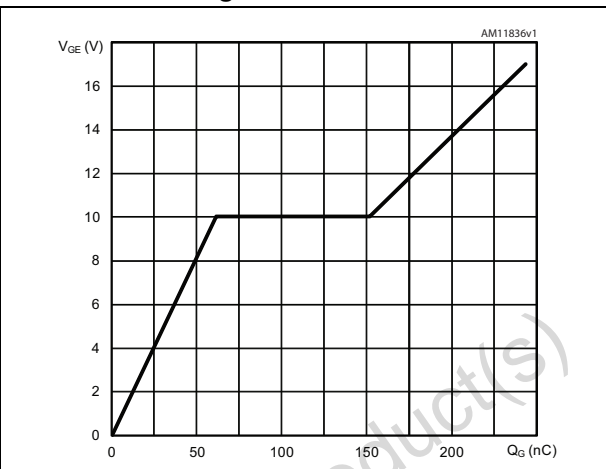

Figure 10. Capacitance variations ( $f = 1\text{ MHz}$ ,  $V_{GE} = 0$ )

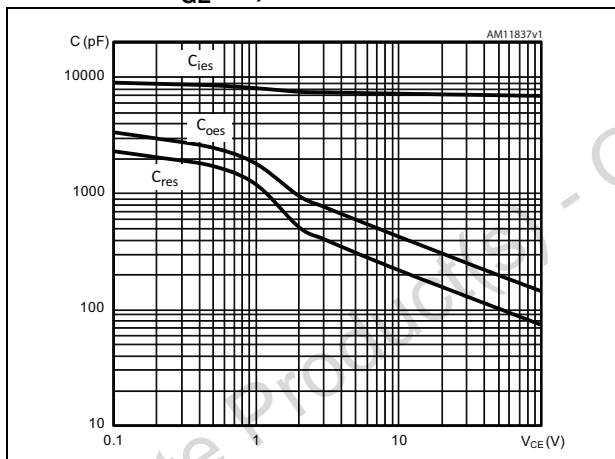

Figure 11. Switching losses vs. collector current

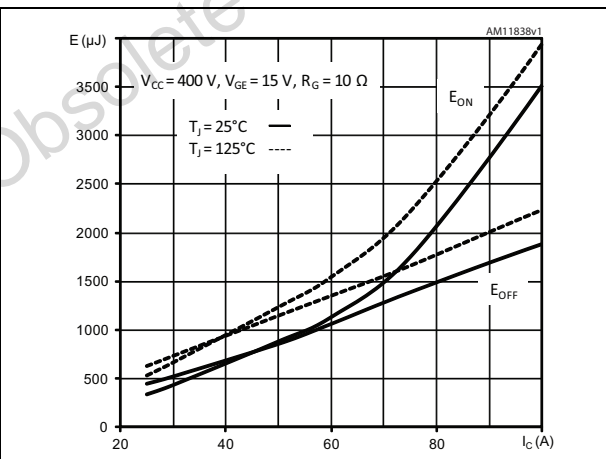

Figure 12. Switching losses vs. gate resistance

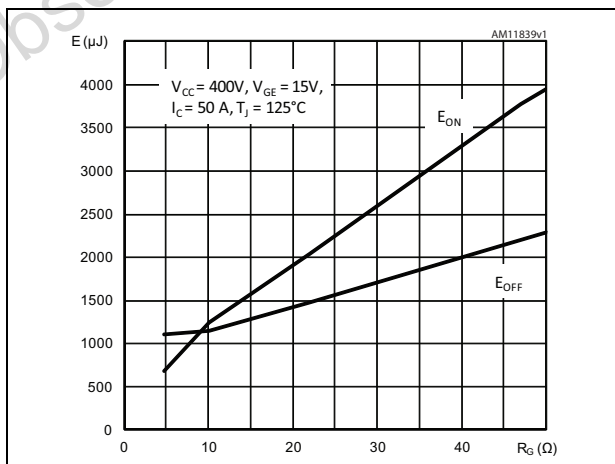

Figure 13. Switching losses vs. temperature

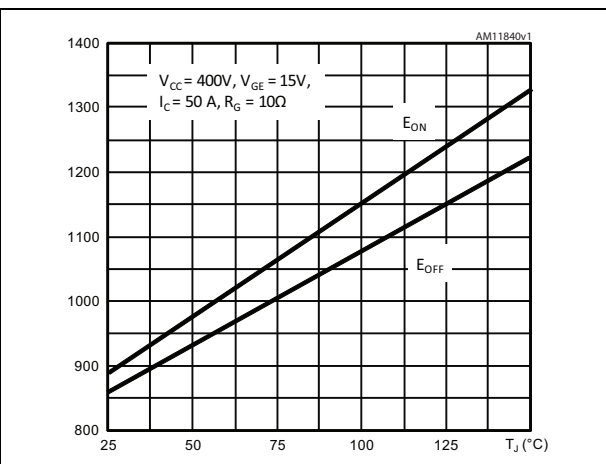

Figure 14. Turn-OFF SOA

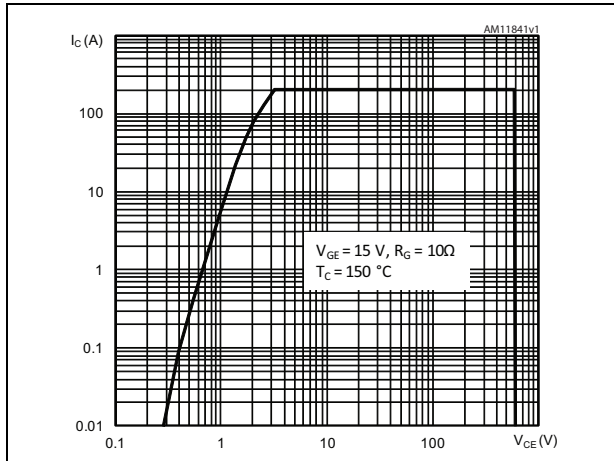

Figure 15. Short circuit time & current vs. VGE

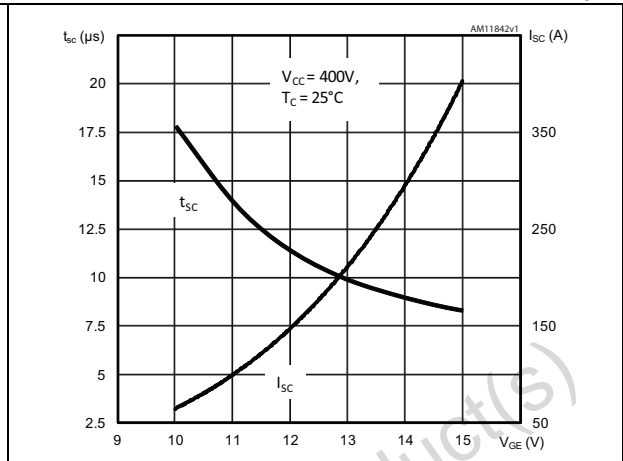

Figure 16. Diode forward current vs. forward voltage

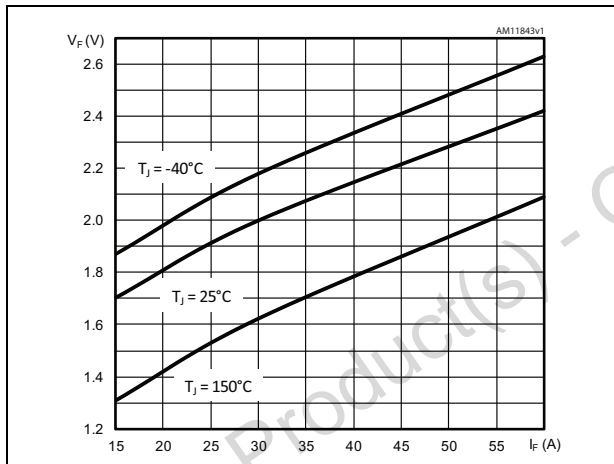

Figure 17. Diode forward current vs. junction temperature

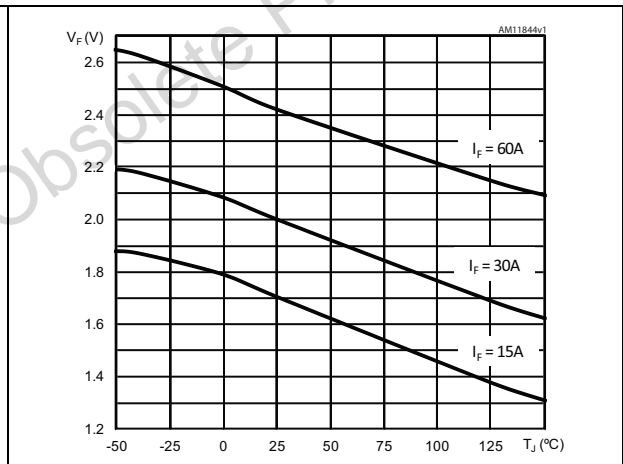

Figure 18. Maximum normalized Zth junction to case (IGBT)

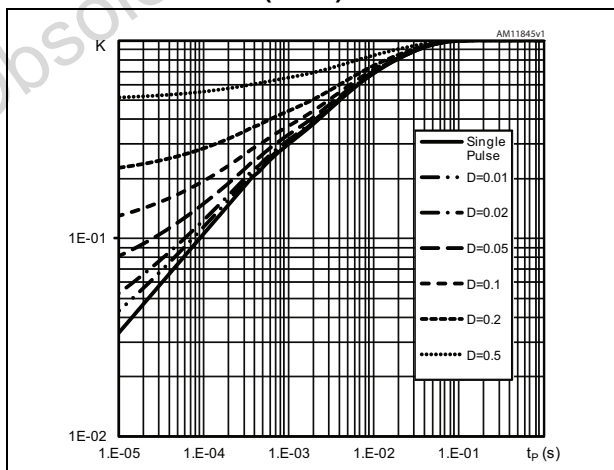
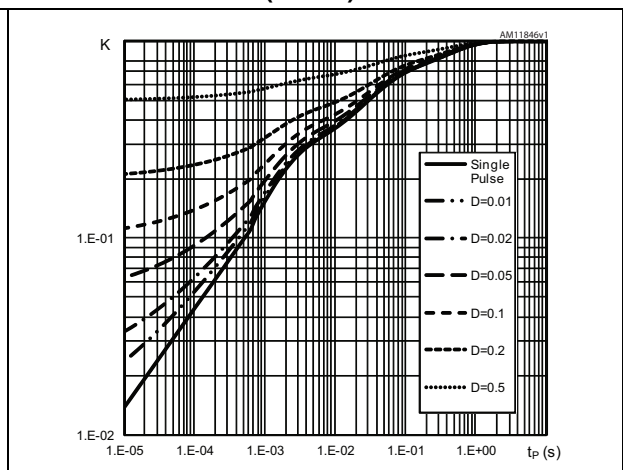
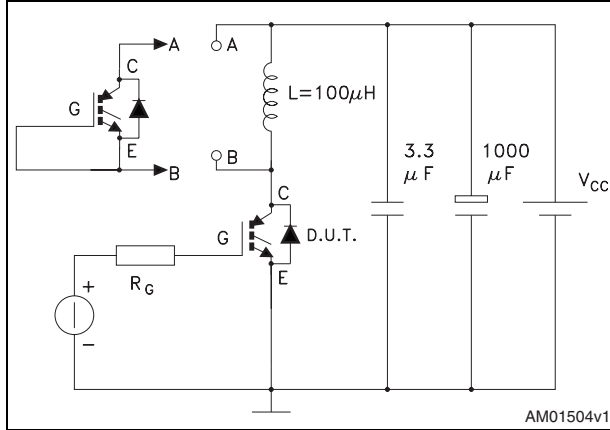

Figure 19. Maximum normalized Zth junction to case (Diode)



### 3 Test circuits

Figure 20. Test circuit for inductive load switching



AM01504v1

Figure 21. Gate charge test circuit

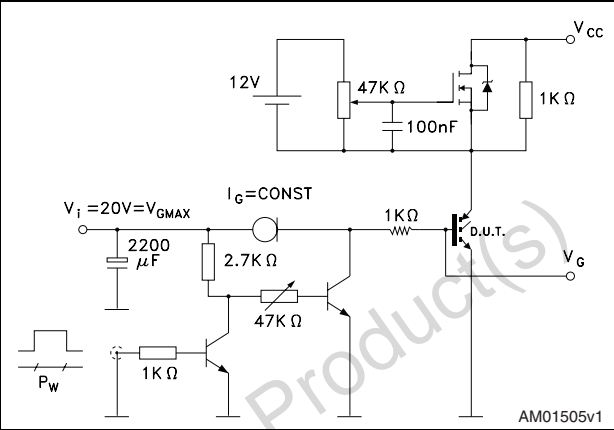

AM01505v1

Figure 22. Switching waveform

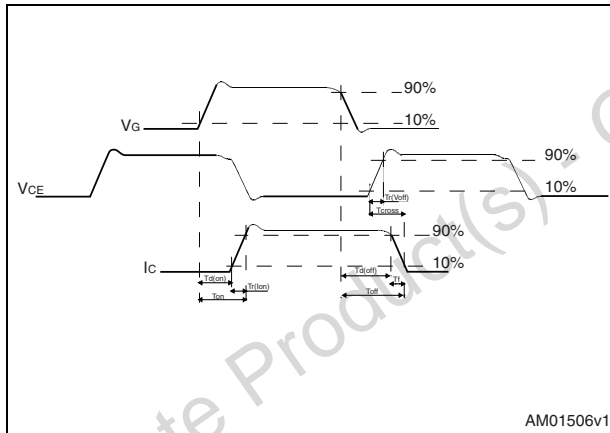

AM01506v1

Figure 23. Diode recovery time waveform

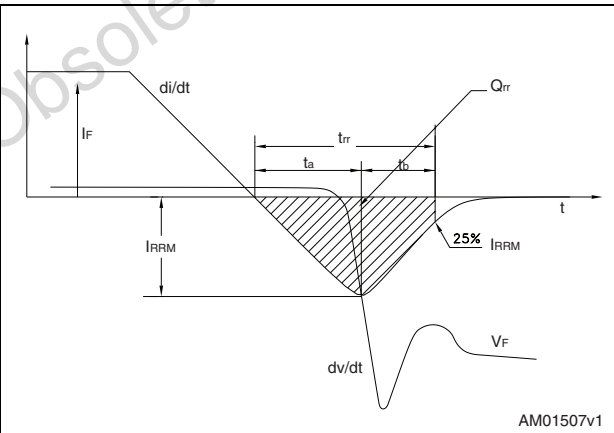

AM01507v1



## 4 Package mechanical data

In order to meet environmental requirements, ST offers these devices in different grades of ECOPACK® packages, depending on their level of environmental compliance. ECOPACK® specifications, grade definitions and product status are available at: [www.st.com](http://www.st.com). ECOPACK® is an ST trademark.

**Table 9. TO-247 mechanical data**

Dim.	mm.		
	Min.	Typ.	Max.
A	4.85		5.15
A1	2.20		2.60
b	1.0		1.40
b1	2.0		2.40
b2	3.0		3.40
c	0.40		0.80
D	19.85		20.15
E	15.45		15.75
e		5.45	
L	14.20		14.80
L1	3.70		4.30
L2		18.50	
ØP	3.55		3.65
ØR	4.50		5.50
S		5.50	



## 5 Revision history

Table 10. Document revision history

Date	Revision	Changes
28-Apr-2011	1	Initial release.
26-Jul-2011	2	Added: $t_{SC}$ and $T_{STG}$ <a href="#">Table 2 on page 2</a> . Updated: <a href="#">Table 4</a> , <a href="#">Table 5</a> , <a href="#">Table 6 on page 3</a> and <a href="#">Table 7 on page 4</a> .
12-Jan-2012	3	Document status promoted from preliminary data to datasheet.
10-Feb-2012	4	Added: <a href="#">Section 2.1: Electrical characteristics (curves)</a> .
26-Jul-2012	5	Modified: <a href="#">Figure 8 on page 6</a> .

**Please Read Carefully:**

Information in this document is provided solely in connection with ST products. STMicroelectronics NV and its subsidiaries ("ST") reserve the right to make changes, corrections, modifications or improvements, to this document, and the products and services described herein at any time, without notice.

All ST products are sold pursuant to ST's terms and conditions of sale.

Purchasers are solely responsible for the choice, selection and use of the ST products and services described herein, and ST assumes no liability whatsoever relating to the choice, selection or use of the ST products and services described herein.

No license, express or implied, by estoppel or otherwise, to any intellectual property rights is granted under this document. If any part of this document refers to any third party products or services it shall not be deemed a license grant by ST for the use of such third party products or services, or any intellectual property contained therein or considered as a warranty covering the use in any manner whatsoever of such third party products or services or any intellectual property contained therein.

**UNLESS OTHERWISE SET FORTH IN ST'S TERMS AND CONDITIONS OF SALE ST DISCLAIMS ANY EXPRESS OR IMPLIED WARRANTY WITH RESPECT TO THE USE AND/OR SALE OF ST PRODUCTS INCLUDING WITHOUT LIMITATION IMPLIED WARRANTIES OF MERCHANTABILITY, FITNESS FOR A PARTICULAR PURPOSE (AND THEIR EQUIVALENTS UNDER THE LAWS OF ANY JURISDICTION), OR INFRINGEMENT OF ANY PATENT, COPYRIGHT OR OTHER INTELLECTUAL PROPERTY RIGHT.**

**UNLESS EXPRESSLY APPROVED IN WRITING BY TWO AUTHORIZED ST REPRESENTATIVES, ST PRODUCTS ARE NOT RECOMMENDED, AUTHORIZED OR WARRANTED FOR USE IN MILITARY, AIR CRAFT, SPACE, LIFE SAVING, OR LIFE SUSTAINING APPLICATIONS, NOR IN PRODUCTS OR SYSTEMS WHERE FAILURE OR MALFUNCTION MAY RESULT IN PERSONAL INJURY, DEATH, OR SEVERE PROPERTY OR ENVIRONMENTAL DAMAGE. ST PRODUCTS WHICH ARE NOT SPECIFIED AS "AUTOMOTIVE GRADE" MAY ONLY BE USED IN AUTOMOTIVE APPLICATIONS AT USER'S OWN RISK.**

Resale of ST products with provisions different from the statements and/or technical features set forth in this document shall immediately void any warranty granted by ST for the ST product or service described herein and shall not create or extend in any manner whatsoever, any liability of ST.

ST and the ST logo are trademarks or registered trademarks of ST in various countries.

Information in this document supersedes and replaces all information previously supplied.

The ST logo is a registered trademark of STMicroelectronics. All other names are the property of their respective owners.

© 2012 STMicroelectronics - All rights reserved

STMicroelectronics group of companies

Australia - Belgium - Brazil - Canada - China - Czech Republic - Finland - France - Germany - Hong Kong - India - Israel - Italy - Japan - Malaysia - Malta - Morocco - Philippines - Singapore - Spain - Sweden - Switzerland - United Kingdom - United States of America

[www.st.com](http://www.st.com)

## X-ON Electronics

Largest Supplier of Electrical and Electronic Components

*Click to view similar products for [IGBT Transistors](#) category:*

*Click to view products by [STMicroelectronics](#) manufacturer:*

Other Similar products are found below :

[748152A](#) [APT20GT60BRDQ1G](#) [APT50GT60BRG](#) [NGTB10N60FG](#) [STGFW20V60DF](#) [APT30GP60BG](#) [APT45GR65B2DU30](#)  
[GT50JR22\(STA1ES\)](#) [TIG058E8-TL-H](#) [VS-CPV364M4KPBF](#) [NGTB25N120FL2WAG](#) [NGTG40N120FL2WG](#) [RJH60F3DPQ-A0#T0](#)  
[APT40GR120B2SCD10](#) [APT15GT120BRG](#) [APT20GT60BRG](#) [NGTB75N65FL2WAG](#) [NGTG15N120FL2WG](#) [IXA30RG1200DHGLB](#)  
[IXA40RG1200DHGLB](#) [APT70GR65B2DU40](#) [NTE3320](#) [IHF40N65R5SXXKSA1](#) [APT70GR120J](#) [APT35GP120JDQ2](#)  
[IKZA40N65RH5XKSA1](#) [IKFW75N65ES5XKSA1](#) [IKFW50N65ES5XKSA1](#) [IKFW50N65EH5XKSA1](#) [IKFW40N65ES5XKSA1](#)  
[IKFW60N65ES5XKSA1](#) [IMBG120R090M1HXTMA1](#) [IMBG120R220M1HXTMA1](#) [XD15H120CX1](#) [XD25H120CX0](#) [XP15PJS120CL1B1](#)  
[IGW30N60H3FKSA1](#) [STGWA8M120DF3](#) [IGW08T120FKSA1](#) [IGW75N60H3FKSA1](#) [HGTG40N60B3](#) [FGH60N60SMD\\_F085](#)  
[FGH75T65UPD](#) [STGWA15H120F2](#) [IKA10N60TXKSA1](#) [IHW20N120R5XKSA1](#) [RJH60D2DPP-M0#T2](#) [IKP20N60TXKSA1](#)  
[IHW20N65R5XKSA1](#) [IDW40E65D2FKSA1](#)