

Trench gate field-stop, 650 V, 50 A, high-speed HB2 series IGBT in a TO-247 long leads package

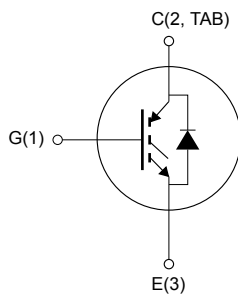

TO-247 long leads



NG1E3C2T



Features

- Maximum junction temperature : $T_J = 175\text{ °C}$
- Low $V_{CE(sat)} = 1.55\text{ V (typ.) @ } I_C = 50\text{ A}$
- Co-packaged protection diode
- Minimized tail current
- Tight parameter distribution
- Low thermal resistance
- Positive $V_{CE(sat)}$ temperature coefficient

Applications

- Welding
- Power factor correction

Description

The newest IGBT 650 V HB2 series represents an evolution of the advanced proprietary trench gate field-stop structure. The performance of the HB2 series is optimized in terms of conduction, thanks to a better $V_{CE(sat)}$ behavior at low current values, as well as in terms of reduced switching energy. A diode used for protection purposes only is co-packaged in antiparallel with the IGBT. The result is a product specifically designed to maximize efficiency for a wide range of fast applications.

Product status link

[STGWA50HP65FB2](#)

Product summary

| | |
|-------------------|-------------------|
| Order code | STGWA50HP65FB2 |
| Marking | G50HP65FB2 |
| Package | TO-247 long leads |
| Packing | Tube |

1 Electrical ratings

Table 1. Absolute maximum ratings

| Symbol | Parameter | Value | Unit |
|-------------------|--|------------|------|
| V_{CES} | Collector-emitter voltage ($V_{GE} = 0$ V) | 650 | V |
| I_C | Continuous collector current at $T_C = 25$ °C | 86 | A |
| | Continuous collector current at $T_C = 100$ °C | 53 | A |
| $I_{CP}^{(1)(2)}$ | Pulsed collector current | 150 | A |
| V_{GE} | Gate-emitter voltage | ±20 | V |
| | Transient gate-emitter voltage ($t_p \leq 10$ µs) | ±30 | |
| I_F | Continuous forward current at $T_C = 25$ °C | 5 | A |
| | Continuous forward current at $T_C = 100$ °C | 5 | |
| $I_{FP}^{(1)(2)}$ | Pulsed forward current | 10 | A |
| P_{TOT} | Total power dissipation at $T_C = 25$ °C | 272 | W |
| T_{STG} | Storage temperature range | -55 to 150 | °C |
| T_J | Operating junction temperature range | -55 to 175 | °C |

1. Pulse width is limited by maximum junction temperature.
2. Defined by design, not subject to production test.

Table 2. Thermal data

| Symbol | Parameter | Value | Unit |
|------------|--|-------|------|
| R_{thJC} | Thermal resistance junction-case IGBT | 0.55 | °C/W |
| | Thermal resistance junction-case diode | 5 | |
| R_{thJA} | Thermal resistance junction-ambient | 50 | |

2 Electrical characteristics

$T_C = 25\text{ °C}$ unless otherwise specified

Table 3. Static characteristics

| Symbol | Parameter | Test conditions | Min. | Typ. | Max. | Unit |
|---------------|--------------------------------------|--|------|------|-----------|---------------|
| $V_{(BR)CES}$ | Collector-emitter breakdown voltage | $V_{GE} = 0\text{ V}, I_C = 1\text{ mA}$ | 650 | | | V |
| $V_{CE(sat)}$ | Collector-emitter saturation voltage | $V_{GE} = 15\text{ V}, I_C = 50\text{ A}$ | | 1.55 | 2 | V |
| | | $V_{GE} = 15\text{ V}, I_C = 50\text{ A}, T_J = 125\text{ °C}$ | | 1.8 | | |
| | | $V_{GE} = 15\text{ V}, I_C = 50\text{ A}, T_J = 175\text{ °C}$ | | 1.9 | | |
| V_F | Forward on-voltage | $I_F = 5\text{ A}$ | | 2 | 2.8 | V |
| | | $I_F = 5\text{ A}, T_J = 125\text{ °C}$ | | 1.85 | | |
| | | $I_F = 5\text{ A}, T_J = 175\text{ °C}$ | | 1.75 | | |
| $V_{GE(th)}$ | Gate threshold voltage | $V_{CE} = V_{GE}, I_C = 1\text{ mA}$ | 5 | 6 | 7 | V |
| I_{CES} | Collector cut-off current | $V_{GE} = 0\text{ V}, V_{CE} = 650\text{ V}$ | | | 25 | μA |
| I_{GES} | Gate-emitter leakage current | $V_{CE} = 0\text{ V}, V_{GE} = \pm 20\text{ V}$ | | | ± 250 | nA |

Table 4. Dynamic characteristics

| Symbol | Parameter | Test conditions | Min. | Typ. | Max. | Unit |
|-----------|------------------------------|---|------|------|------|------|
| C_{ies} | Input capacitance | $V_{CE} = 25\text{ V}, f = 1\text{ MHz}, V_{GE} = 0\text{ V}$ | - | 2928 | - | pF |
| C_{oes} | Output capacitance | | - | 162 | - | |
| C_{res} | Reverse transfer capacitance | | - | 78 | - | |
| Q_g | Total gate charge | $V_{CC} = 520\text{ V}, I_C = 50\text{ A},$ | - | 151 | - | nC |
| Q_{ge} | Gate-emitter charge | $V_{GE} = 0\text{ to }15\text{ V}$ | - | 30 | - | |
| Q_{gc} | Gate-collector charge | (see Figure 27. Gate charge test circuit) | - | 63 | - | |

Table 5. Switching characteristics (inductive load)

| Symbol | Parameter | Test conditions | Min. | Typ. | Max. | Unit |
|-----------------|---------------------------|---|------|------|------|---------------|
| $t_{d(off)}$ | Turn-off delay time | $V_{CC} = 400\text{ V}$, $I_C = 50\text{ A}$, | - | 115 | - | ns |
| t_f | Current fall time | $V_{GE} = 15\text{ V}$, $R_G = 4.7\ \Omega$ | - | 40 | - | ns |
| $E_{off}^{(1)}$ | Turn-off switching energy | (see Figure 26. Test circuit for inductive load switching) | - | 580 | - | μJ |
| $t_{d(off)}$ | Turn-off delay time | $V_{CC} = 400\text{ V}$, $I_C = 50\text{ A}$, | - | 135 | - | ns |
| t_f | Current fall time | $V_{GE} = 15\text{ V}$, $R_G = 4.7\ \Omega$, | - | 90 | - | ns |
| $E_{off}^{(1)}$ | Turn-off switching energy | $T_J = 175\text{ }^\circ\text{C}$ (see Figure 26. Test circuit for inductive load switching) | - | 1090 | - | μJ |

1. Including the tail of the collector current.

Table 6. Diode switching characteristics (inductive load)

| Symbol | Parameter | Test conditions | Min. | Typ. | Max. | Unit |
|--------------|--|--|------|------|------|------------------------|
| t_{rr} | Reverse recovery time | $I_F = 5\text{ A}$, $V_R = 400\text{ V}$, $V_{GE} = 15\text{ V}$, $di/dt = 1000\text{ A}/\mu\text{s}$ (see Figure 29. Diode reverse recovery waveform) | - | 140 | - | ns |
| Q_{rr} | Reverse recovery charge | | - | 21 | - | nC |
| I_{rrm} | Reverse recovery current | | - | 6.6 | - | A |
| di_{rr}/dt | Peak rate of fall of reverse recovery current during t_b | | - | 430 | - | $\text{A}/\mu\text{s}$ |
| E_{rr} | Reverse recovery energy | | - | 1.6 | - | μJ |
| t_{rr} | Reverse recovery time | $I_F = 5\text{ A}$, $V_R = 400\text{ V}$, $V_{GE} = 15\text{ V}$, $di/dt = 1000\text{ A}/\mu\text{s}$, $T_J = 175\text{ }^\circ\text{C}$ (see Figure 29. Diode reverse recovery waveform) | - | 200 | - | ns |
| Q_{rr} | Reverse recovery charge | | - | 47.3 | - | nC |
| I_{rrm} | Reverse recovery current | | - | 9.6 | - | A |
| di_{rr}/dt | Peak rate of fall of reverse recovery current during t_b | | - | 428 | - | $\text{A}/\mu\text{s}$ |
| E_{rr} | Reverse recovery energy | | - | 3.2 | - | μJ |

2.1 Electrical characteristics (curves)

Figure 1. Power dissipation vs case temperature

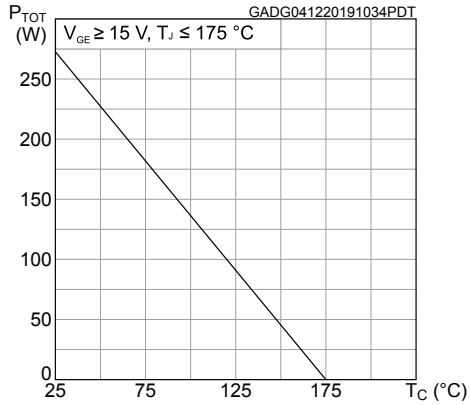

Figure 2. Collector current vs case temperature

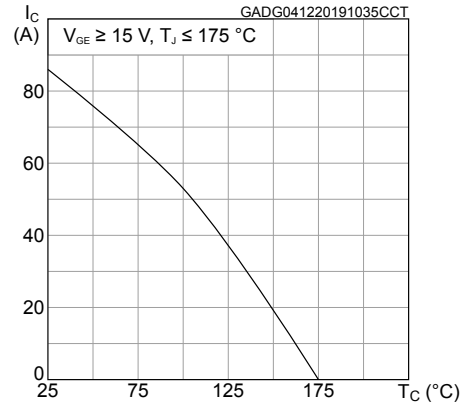

Figure 3. Output characteristics (T_J = 25 °C)

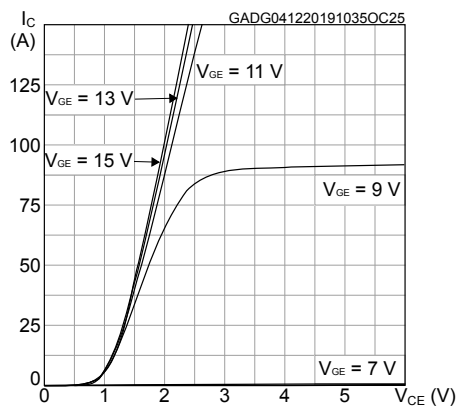

Figure 4. Output characteristics (T_J = 175 °C)

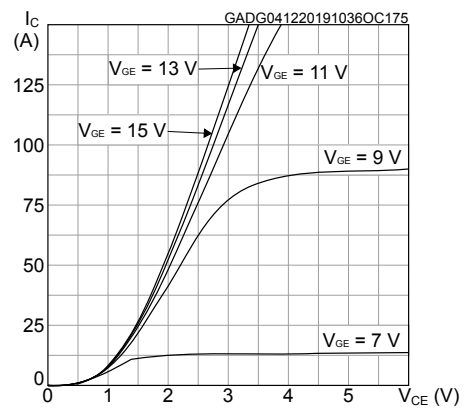

Figure 5. V_{CE(sat)} vs junction temperature

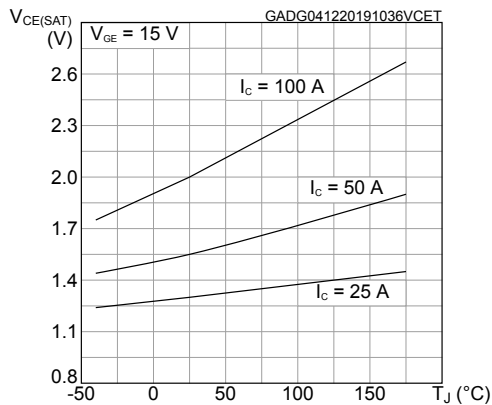

Figure 6. V_{CE(sat)} vs collector current

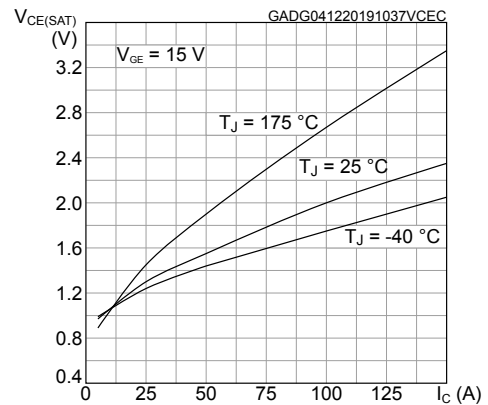

Figure 7. Forward bias safe operating area

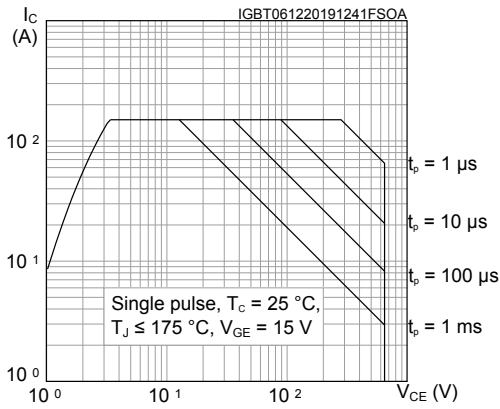

Figure 8. Transfer characteristics

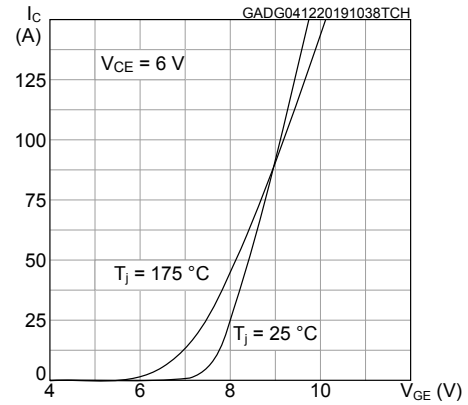

Figure 9. Diode V_F vs forward current

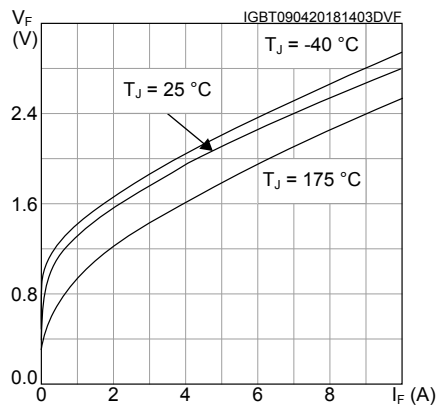

Figure 10. Normalized V_GE(th) vs junction temperature

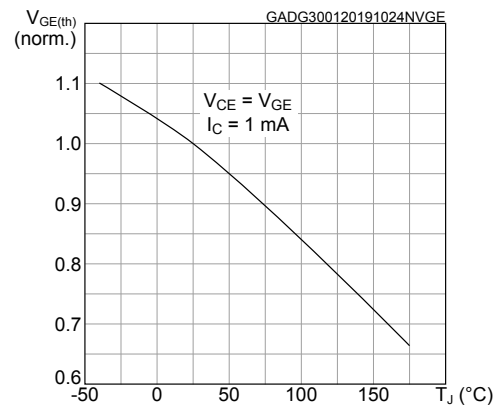

Figure 11. Normalized V_(BR)CES vs junction temperature

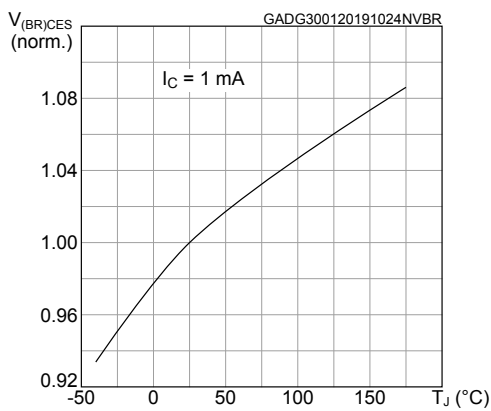

Figure 12. Capacitance variations

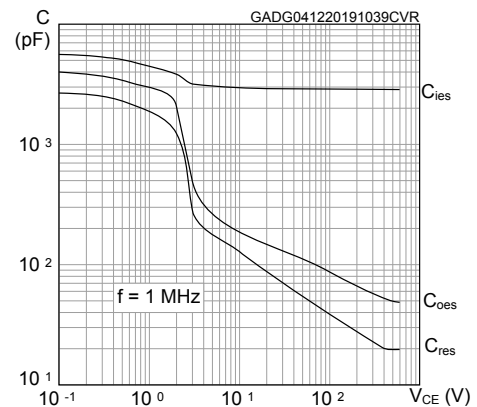

Figure 13. Gate charge vs gate-emitter voltage

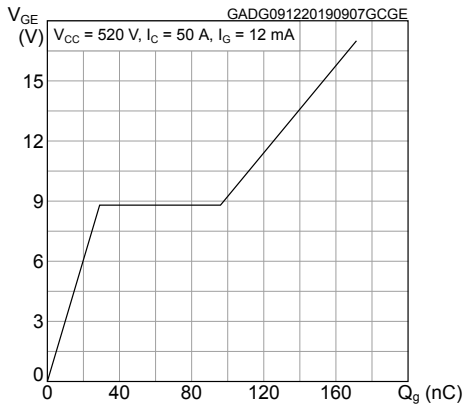

Figure 14. Switching energy vs collector current

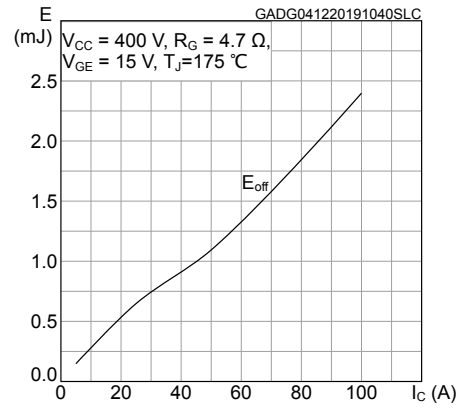

Figure 15. Switching energy vs temperature

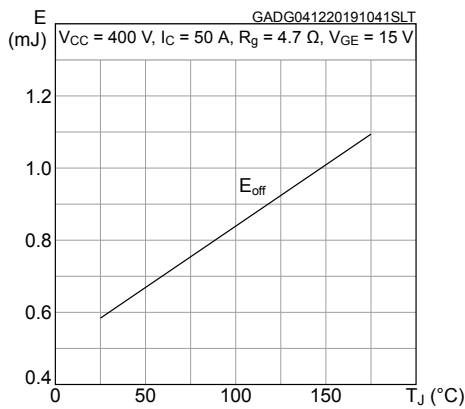

Figure 16. Switching energy vs collector emitter voltage

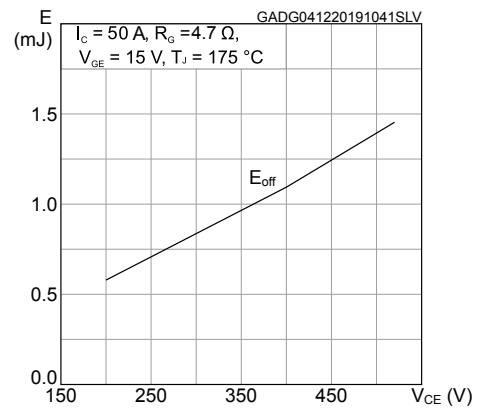

Figure 17. Switching energy vs gate resistance

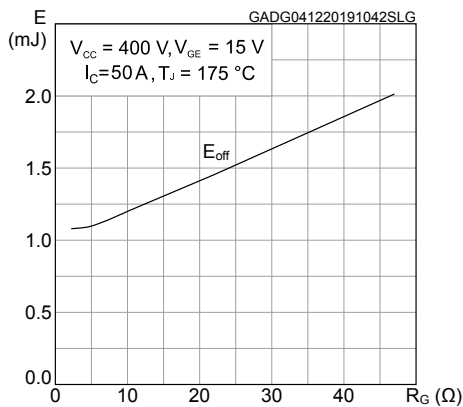

Figure 18. Switching times vs collector current

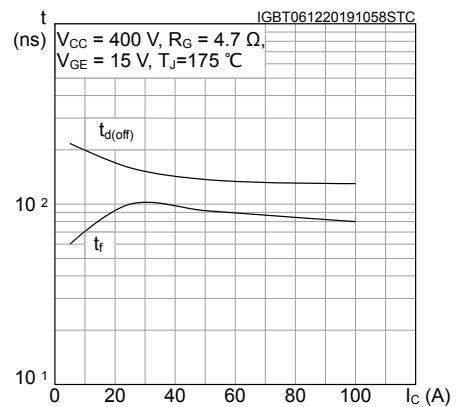

Figure 19. Switching times vs gate resistance

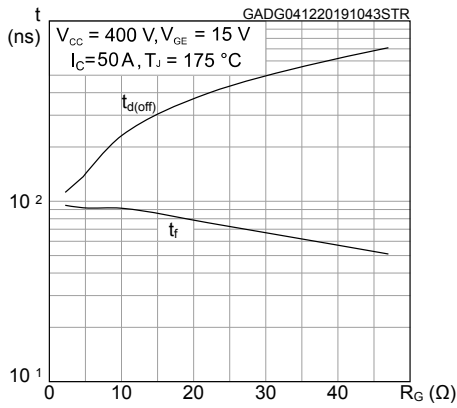

Figure 20. Reverse recovery current vs diode current slope

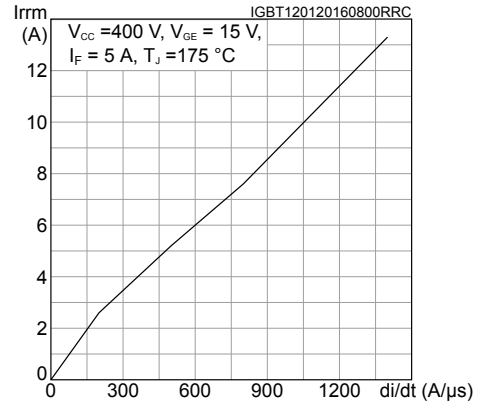

Figure 21. Reverse recovery time vs diode current slope

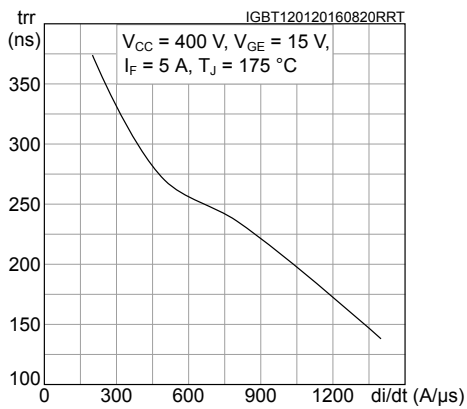

Figure 22. Reverse recovery charge vs diode current slope

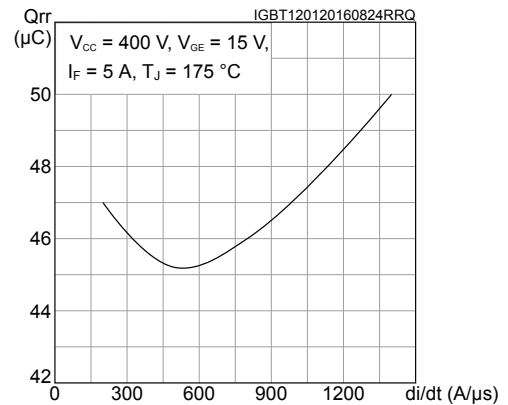

Figure 23. Reverse recovery energy vs diode current slope

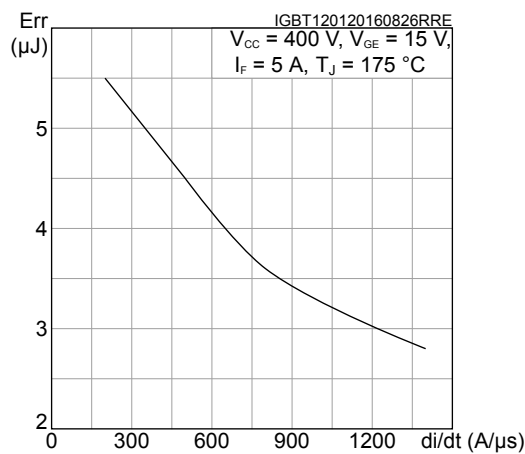

Figure 24. Thermal impedance for IGBT

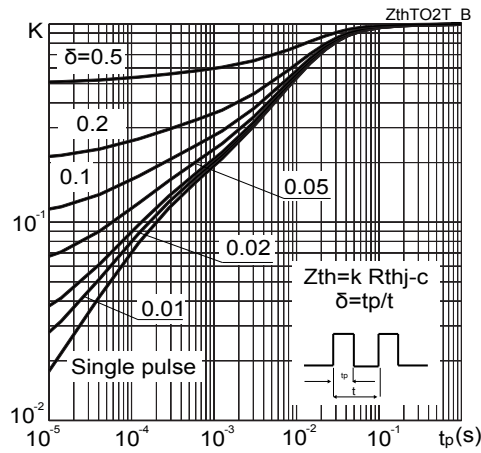
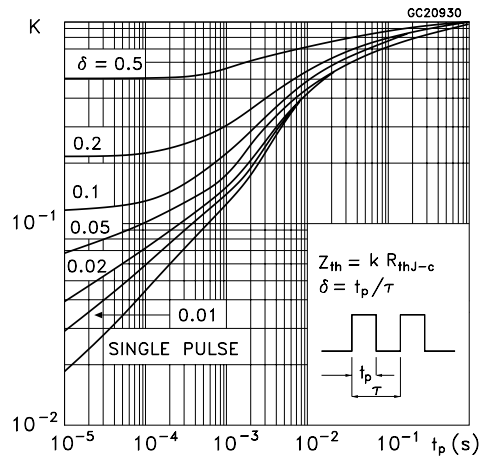
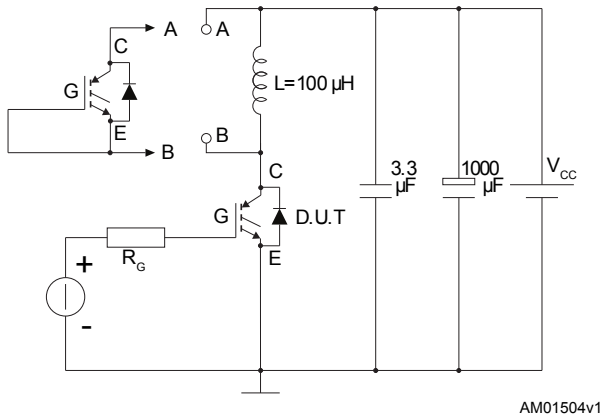
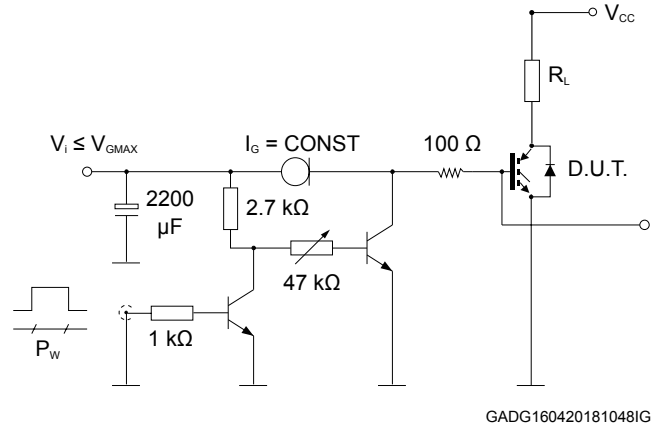
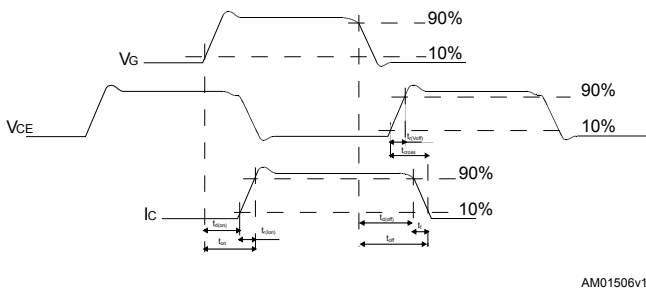
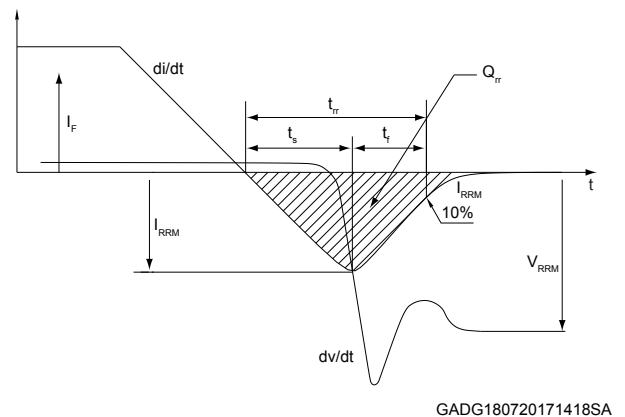

Figure 25. Thermal impedance for diode



3 Test circuits

Figure 26. Test circuit for inductive load switching

Figure 27. Gate charge test circuit

Figure 28. Switching waveform

Figure 29. Diode reverse recovery waveform

4 Package information

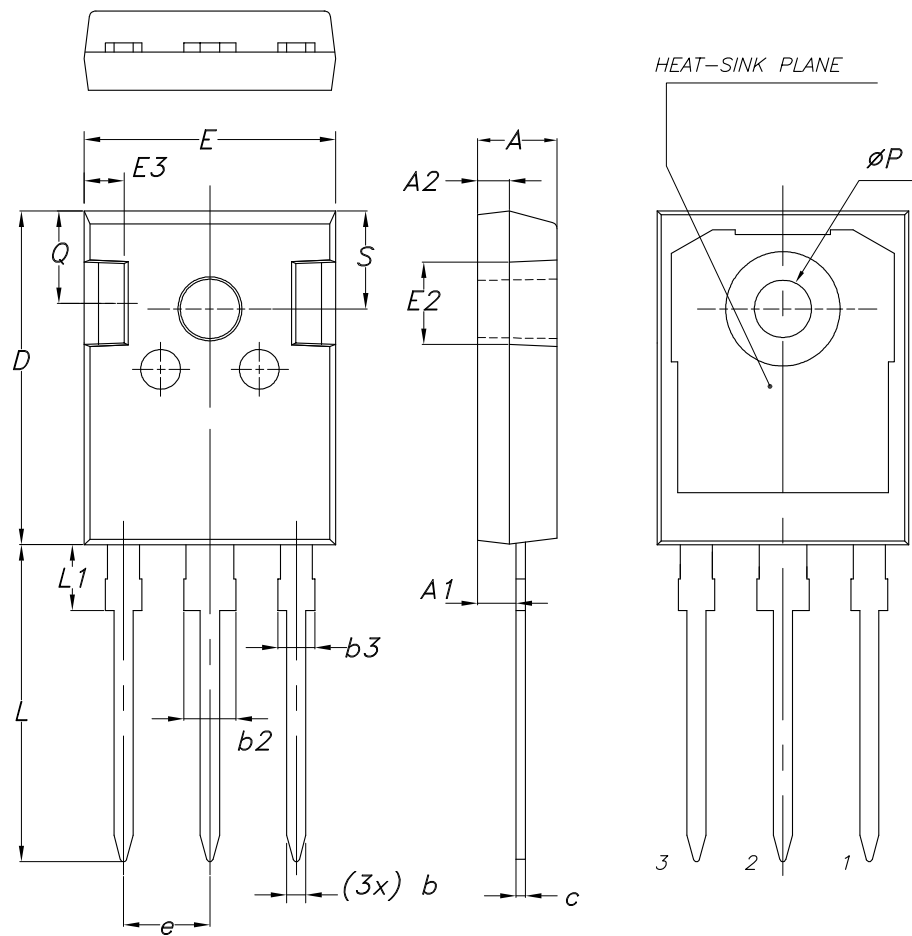
In order to meet environmental requirements, ST offers these devices in different grades of **ECOPACK** packages, depending on their level of environmental compliance. ECOPACK specifications, grade definitions and product status are available at: www.st.com. ECOPACK is an ST trademark.

4.1 TO-247 long leads package information

Figure 30. TO-247 long leads package outline



8463846_2_F

Table 7. TO-247 long leads package mechanical data

| Dim. | mm | | |
|------|-------|-------|-------|
| | Min. | Typ. | Max. |
| A | 4.90 | 5.00 | 5.10 |
| A1 | 2.31 | 2.41 | 2.51 |
| A2 | 1.90 | 2.00 | 2.10 |
| b | 1.16 | | 1.26 |
| b2 | | | 3.25 |
| b3 | | | 2.25 |
| c | 0.59 | | 0.66 |
| D | 20.90 | 21.00 | 21.10 |
| E | 15.70 | 15.80 | 15.90 |
| E2 | 4.90 | 5.00 | 5.10 |
| E3 | 2.40 | 2.50 | 2.60 |
| e | 5.34 | 5.44 | 5.54 |
| L | 19.80 | 19.92 | 20.10 |
| L1 | | | 4.30 |
| P | 3.50 | 3.60 | 3.70 |
| Q | 5.60 | | 6.00 |
| S | 6.05 | 6.15 | 6.25 |

Revision history

Table 8. Document revision history

| Date | Version | Changes |
|-------------|---------|----------------|
| 05-Dec-2019 | 1 | First release. |

Contents

| | | |
|------------|--|-----------|
| 1 | Electrical ratings | 2 |
| 2 | Electrical characteristics | 3 |
| 2.1 | Electrical characteristics (curves) | 5 |
| 3 | Test circuits | 10 |
| 4 | Package information | 11 |
| 4.1 | TO-247 long leads package information | 11 |
| | Revision history | 13 |

IMPORTANT NOTICE – PLEASE READ CAREFULLY

STMicroelectronics NV and its subsidiaries (“ST”) reserve the right to make changes, corrections, enhancements, modifications, and improvements to ST products and/or to this document at any time without notice. Purchasers should obtain the latest relevant information on ST products before placing orders. ST products are sold pursuant to ST’s terms and conditions of sale in place at the time of order acknowledgement.

Purchasers are solely responsible for the choice, selection, and use of ST products and ST assumes no liability for application assistance or the design of Purchasers’ products.

No license, express or implied, to any intellectual property right is granted by ST herein.

Resale of ST products with provisions different from the information set forth herein shall void any warranty granted by ST for such product.

ST and the ST logo are trademarks of ST. For additional information about ST trademarks, please refer to www.st.com/trademarks. All other product or service names are the property of their respective owners.

Information in this document supersedes and replaces information previously supplied in any prior versions of this document.

© 2019 STMicroelectronics – All rights reserved

X-ON Electronics

Largest Supplier of Electrical and Electronic Components

Click to view similar products for [IGBT Transistors](#) category:

Click to view products by [STMicroelectronics](#) manufacturer:

Other Similar products are found below :

[748152A](#) [APT20GT60BRDQ1G](#) [APT50GT60BRG](#) [NGTB10N60FG](#) [STGFW20V60DF](#) [APT30GP60BG](#) [APT45GR65B2DU30](#)
[GT50JR22\(STA1ES\)](#) [TIG058E8-TL-H](#) [VS-CPV364M4KPBF](#) [NGTB25N120FL2WAG](#) [NGTG40N120FL2WG](#) [RJH60F3DPQ-A0#T0](#)
[APT40GR120B2SCD10](#) [APT15GT120BRG](#) [APT20GT60BRG](#) [NGTB75N65FL2WAG](#) [NGTG15N120FL2WG](#) [IXA30RG1200DHGLB](#)
[IXA40RG1200DHGLB](#) [APT70GR65B2DU40](#) [NTE3320](#) [IHF40N65R5SXXKSA1](#) [APT70GR120J](#) [APT35GP120JDQ2](#)
[IKZA40N65RH5XKSA1](#) [IKFW75N65ES5XKSA1](#) [IKFW50N65ES5XKSA1](#) [IKFW50N65EH5XKSA1](#) [IKFW40N65ES5XKSA1](#)
[IKFW60N65ES5XKSA1](#) [IMBG120R090M1HXTMA1](#) [IMBG120R220M1HXTMA1](#) [XD15H120CX1](#) [XD25H120CX0](#) [XP15PJS120CL1B1](#)
[IGW30N60H3FKSA1](#) [STGWA8M120DF3](#) [IGW08T120FKSA1](#) [IGW75N60H3FKSA1](#) [HGTG40N60B3](#) [FGH60N60SMD_F085](#)
[FGH75T65UPD](#) [STGWA15H120F2](#) [IKA10N60TXKSA1](#) [IHW20N120R5XKSA1](#) [RJH60D2DPP-M0#T2](#) [IKP20N60TXKSA1](#)
[IHW20N65R5XKSA1](#) [IDW40E65D2FKSA1](#)