

Trench gate field-stop IGBT, HB series 650 V, 40 A high speed

Datasheet - production data

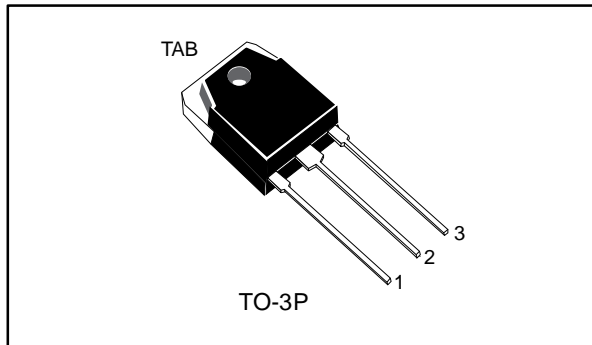
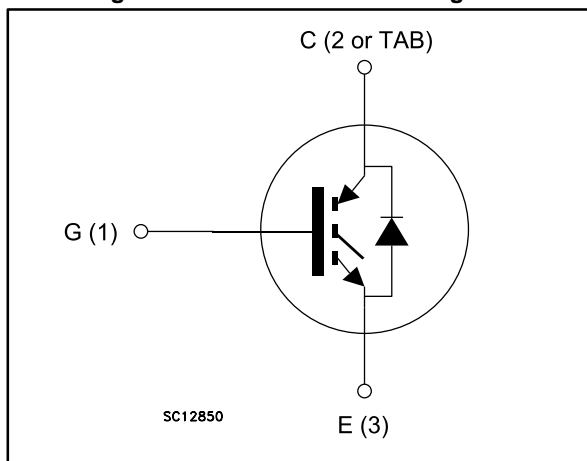

Figure 1: Internal schematic diagram



Features

- Maximum junction temperature: $T_J = 175\text{ °C}$
- Minimized tail current
- $V_{CE(sat)} = 1.6\text{ V (typ.) @ } I_C = 40\text{ A}$
- Tight parameter distribution
- Co-packed diode for protection
- Safe paralleling
- Low thermal resistance

Applications

- Power factor corrector (PFC)

Description

This device is an IGBT developed using an advanced proprietary trench gate field-stop structure. The device is part of the new HB series of IGBTs, which represents an optimum compromise between conduction and switching loss to maximize the efficiency of any frequency converter. Furthermore, the slightly positive $V_{CE(sat)}$ temperature coefficient and very tight parameter distribution result in safer paralleling operation.

Table 1: Device summary

Order code	Marking	Package	Packing
STGWT40HP65FB	GWT40HP65FB	TO-3P	Tube

Contents

1	Electrical ratings	3
2	Electrical characteristics	4
	2.1 Electrical characteristics (curves).....	6
3	Test circuits	12
4	Package information	13
	4.1 TO-3P package information	14
5	Revision history	16

1 Electrical ratings

Table 2: Absolute maximum ratings

Symbol	Parameter	Value	Unit
V_{CES}	Collector-emitter voltage ($V_{GE} = 0$ V)	650	V
I_C	Continuous collector current at $T_C = 25$ °C	80	A
	Continuous collector current at $T_C = 100$ °C	40	
$I_{CP}^{(1)}$	Pulsed collector current	160	A
V_{GE}	Gate-emitter voltage	± 30	V
$I_F^{(2)}$	Continuous forward current at $T_C = 25$ °C	5	A
	Continuous forward current at $T_C = 100$ °C	5	
$I_{FP}^{(3)}$	Pulsed forward current	10	A
P_{TOT}	Total dissipation at $T_C = 25$ °C	283	W
T_{STG}	Storage temperature range	- 55 to 150	°C
T_J	Operating junction temperature range	- 55 to 175	

Notes:

(1)Pulse width limited by maximum junction temperature.

(2)Limited by wires.

(3)Pulsed forward current.

Table 3: Thermal data

Symbol	Parameter	Value	Unit
R_{thJC}	Thermal resistance junction-case IGBT	0.53	°C/W
R_{thJC}	Thermal resistance junction-case diode	5	
R_{thJA}	Thermal resistance junction-ambient	50	

2 Electrical characteristics

$T_J = 25\text{ °C}$ unless otherwise specified

Table 4: Static characteristics

Symbol	Parameter	Test conditions	Min.	Typ.	Max.	Unit
$V_{(BR)CES}$	Collector-emitter breakdown voltage	$V_{GE} = 0\text{ V}$, $I_C = 2\text{ mA}$	650			V
$V_{CE(sat)}$	Collector-emitter saturation voltage	$V_{GE} = 15\text{ V}$, $I_C = 40\text{ A}$		1.6	2.0	V
		$V_{GE} = 15\text{ V}$, $I_C = 40\text{ A}$, $T_J = 125\text{ °C}$		1.7		
		$V_{GE} = 15\text{ V}$, $I_C = 40\text{ A}$, $T_J = 175\text{ °C}$		1.8		
V_F	Forward on-voltage	$I_F = 5\text{ A}$		2		V
		$I_F = 5\text{ A}$, $T_J = 125\text{ °C}$		1.85		
		$I_F = 5\text{ A}$, $T_J = 175\text{ °C}$		1.75		
$V_{GE(th)}$	Gate threshold voltage	$V_{CE} = V_{GE}$, $I_C = 1\text{ mA}$	5	6	7	V
I_{CES}	Collector cut-off current	$V_{GE} = 0\text{ V}$, $V_{CE} = 650\text{ V}$			25	μA
I_{GES}	Gate-emitter leakage current	$V_{CE} = 0\text{ V}$, $V_{GE} = \pm 20\text{ V}$			± 250	nA

Table 5: Dynamic characteristics

Symbol	Parameter	Test conditions	Min.	Typ.	Max.	Unit
C_{ies}	Input capacitance	$V_{CE} = 25\text{ V}$, $f = 1\text{ MHz}$, $V_{GE} = 0\text{ V}$	-	5412	-	pF
C_{oes}	Output capacitance		-	198	-	
C_{res}	Reverse transfer capacitance		-	107	-	
Q_g	Total gate charge	$V_{CC} = 520\text{ V}$, $I_C = 40\text{ A}$, $V_{GE} = 15\text{ V}$ (see Figure 29: "Gate charge test circuit")	-	210	-	nC
Q_{ge}	Gate-emitter charge		-	39	-	
Q_{gc}	Gate-collector charge		-	82	-	

Table 6: IGBT switching characteristics (inductive load)

Symbol	Parameter	Test conditions	Min.	Typ.	Max.	Unit
$t_{d(off)}$	Turn-off-delay time	$V_{CE} = 400\text{ V}$, $I_C = 40\text{ A}$, $V_{GE} = 15\text{ V}$, $R_G = 5\text{ }\Omega$ (see Figure 28: "Test circuit for inductive load switching")	-	142	-	ns
t_f	Current fall time		-	27	-	ns
$E_{off}^{(1)}$	Turn-off switching energy		-	363	-	μJ
$t_{d(off)}$	Turn-off-delay time	$V_{CE} = 400\text{ V}$, $I_C = 40\text{ A}$, $V_{GE} = 15\text{ V}$, $R_G = 5\text{ }\Omega$, $T_J = 175\text{ °C}$ (see Figure 28: "Test circuit for inductive load switching")	-	141	-	ns
t_f	Current fall time		-	61	-	ns
E_{off}	Turn-off switching energy		-	764	-	μJ

Notes:

⁽¹⁾Including the tail of the collector current.

Table 7: Diode switching characteristics (inductive load)

Symbol	Parameter	Test conditions	Min.	Typ.	Max.	Unit
t_{rr}	Reverse recovery time	$I_F = 5 \text{ A}$, $V_R = 400 \text{ V}$, $V_{GE} = 15 \text{ V}$ (see Figure 28: "Test circuit for inductive load switching") $di/dt = 1000 \text{ A}/\mu\text{s}$	-	140		ns
Q_{rr}	Reverse recovery charge		-	21		nC
I_{rrm}	Reverse recovery current		-	6.6		A
di_{rr}/dt	Peak rate of fall of reverse recovery current during t_b		-	430		A/ μs
E_{rr}	Reverse recovery energy		-	1.6		μJ
t_{rr}	Reverse recovery time	$I_F = 5 \text{ A}$, $V_R = 400 \text{ V}$, $V_{GE} = 15 \text{ V}$ $T_J = 175 \text{ }^\circ\text{C}$ (see Figure 28: "Test circuit for inductive load switching") $di/dt = 1000 \text{ A}/\mu\text{s}$	-	200		ns
Q_{rr}	Reverse recovery charge		-	47.3		nC
I_{rrm}	Reverse recovery current		-	9.6		A
di_{rr}/dt	Peak rate of fall of reverse recovery current during t_b		-	428		A/ μs
E_{rr}	Reverse recovery energy		-	3.2		μJ

2.1 Electrical characteristics (curves)

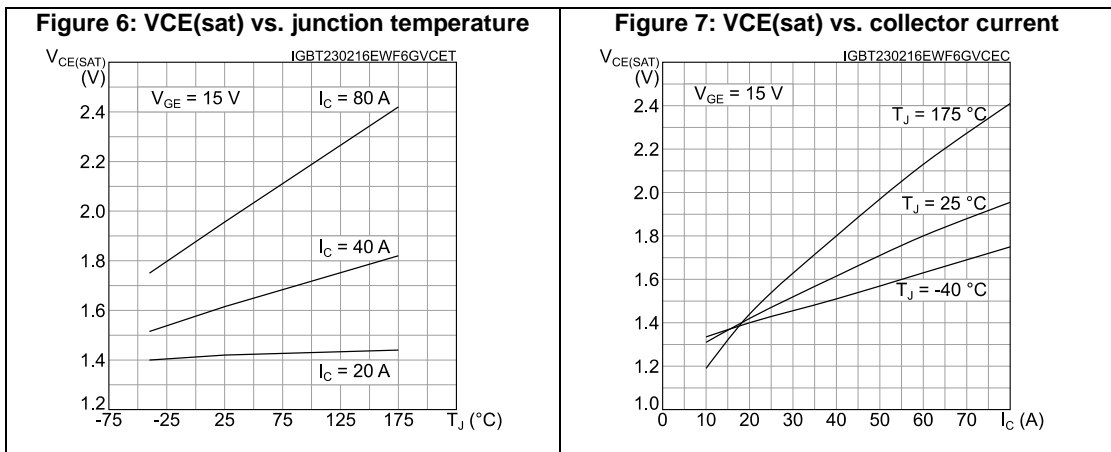
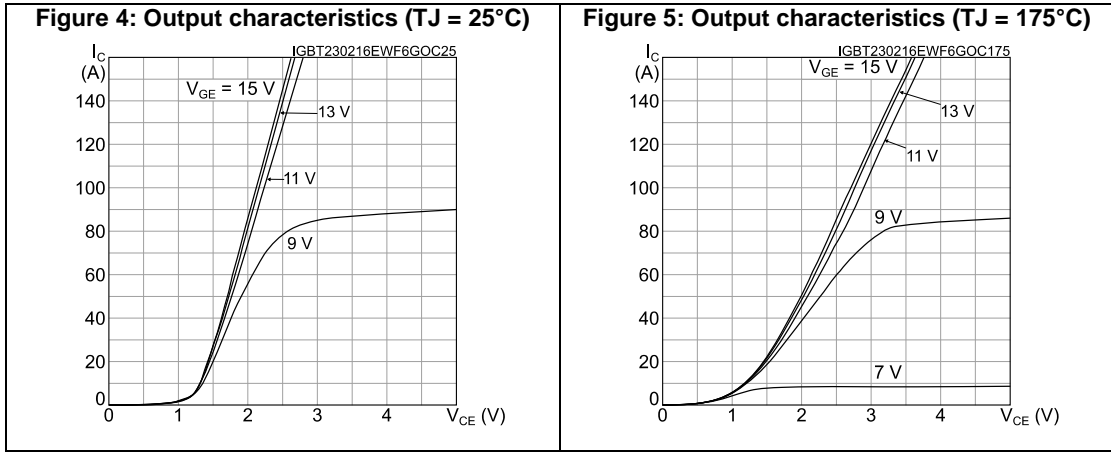
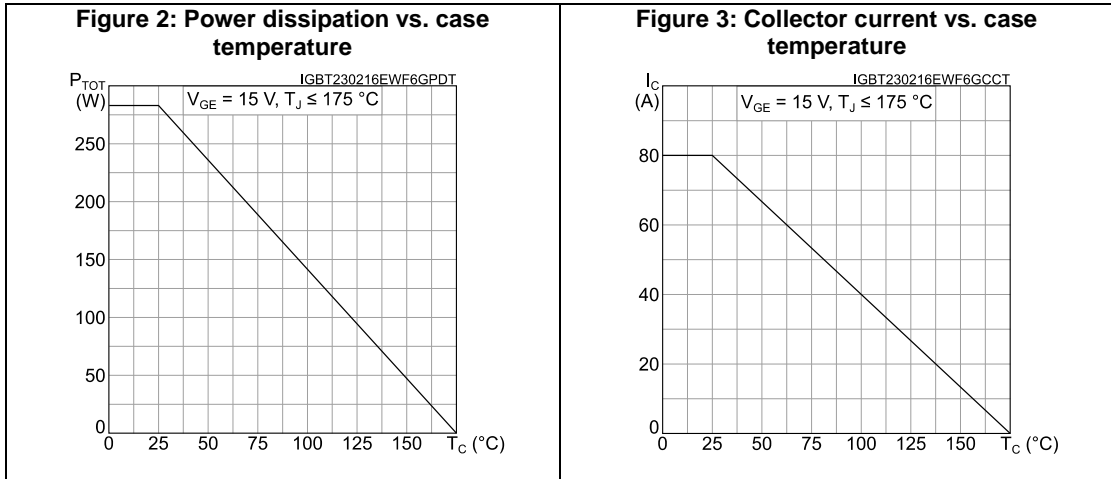

Figure 8: Collector current vs. switching frequency

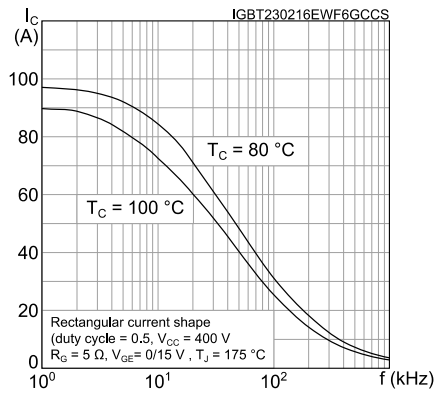

Figure 9: Forward bias safe operating area

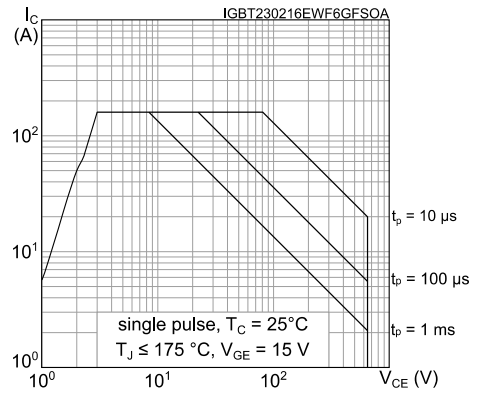

Figure 10: Transfer characteristics

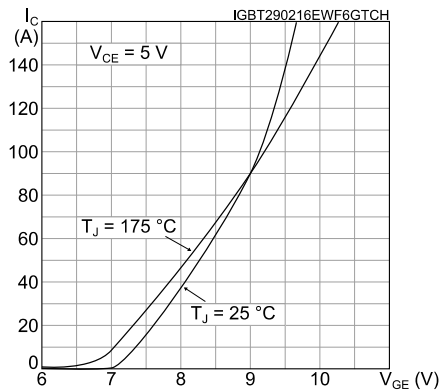

Figure 11: Diode VF vs. forward current

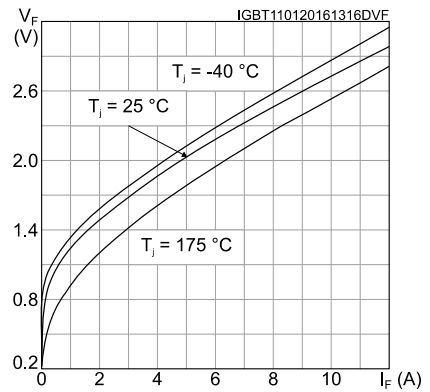

Figure 12: Normalized VGE(th) vs junction temperature

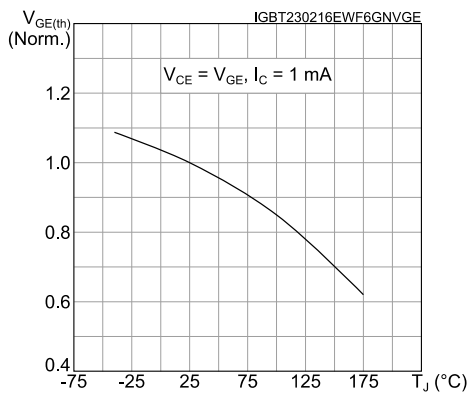
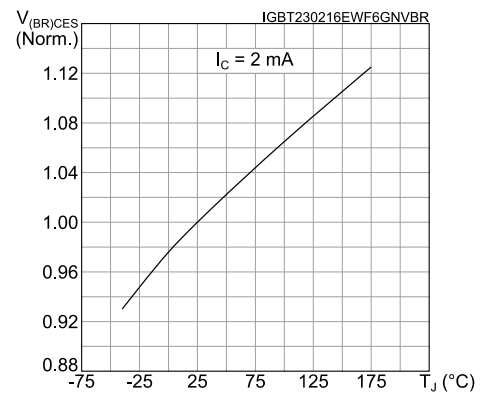

Figure 13: Normalized V(BR)CES vs. junction temperature



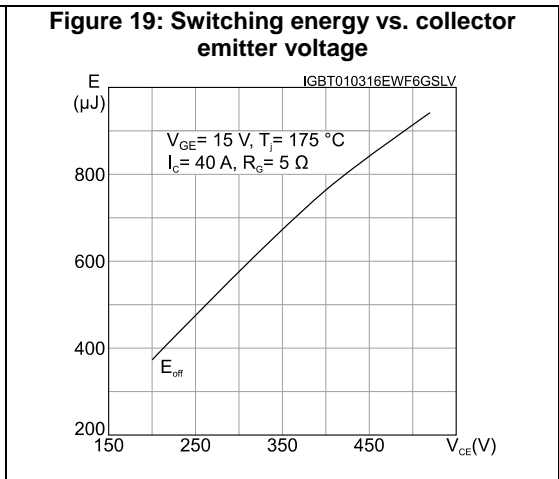
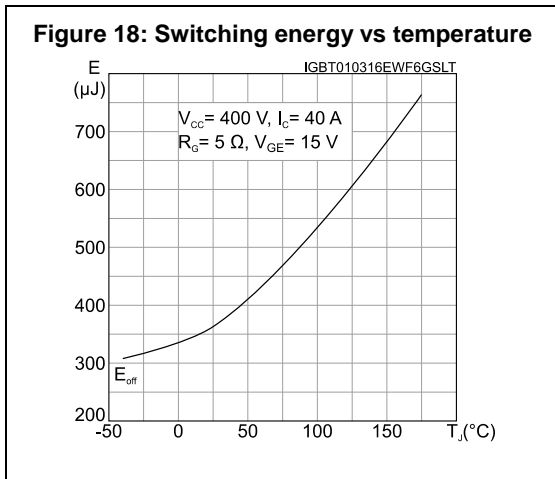
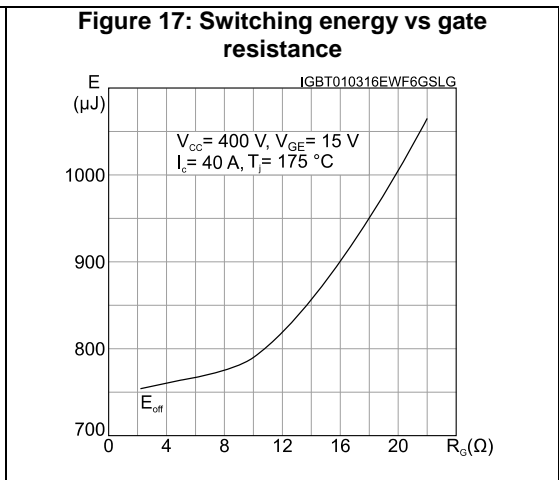
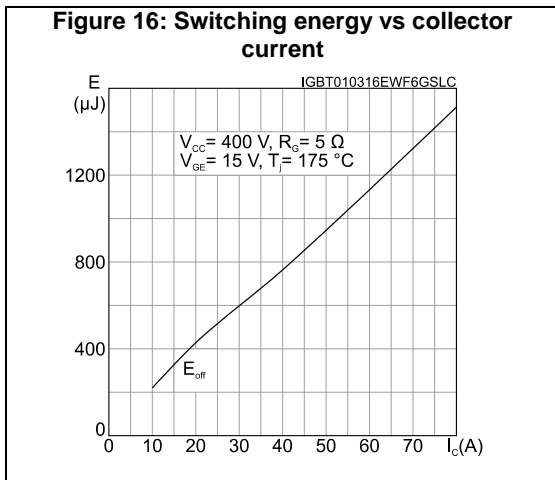
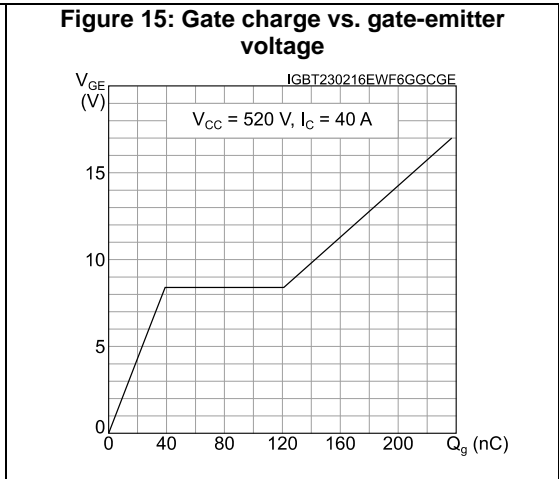
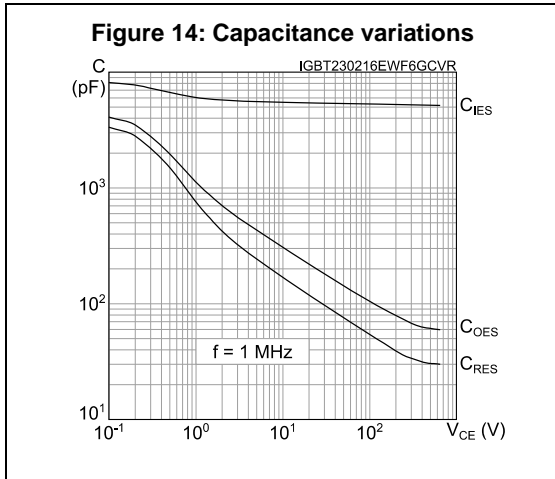

Figure 20: Switching times vs. collector current

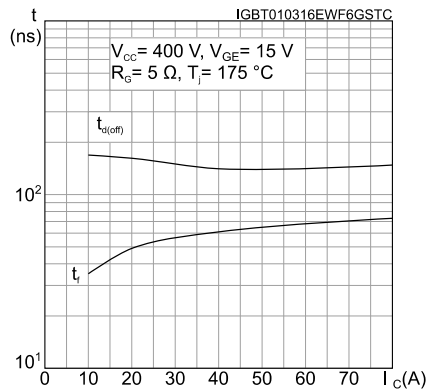

Figure 21: Switching times vs. gate resistance

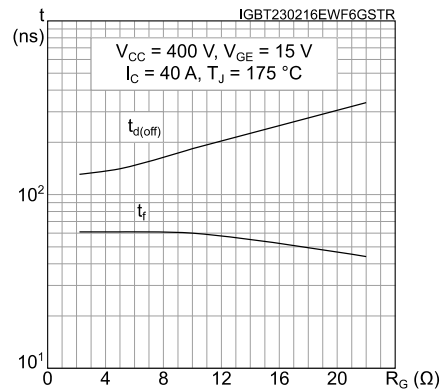

Figure 22: Reverse recovery current vs. diode current slope

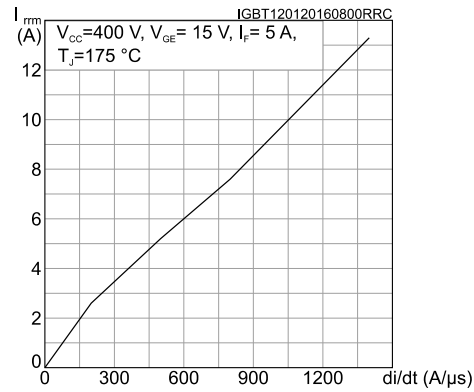

Figure 23: Reverse recovery time vs. diode current slope

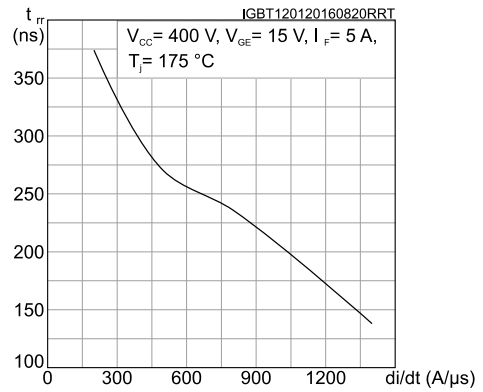

Figure 24: Reverse recovery charge vs. diode current slope

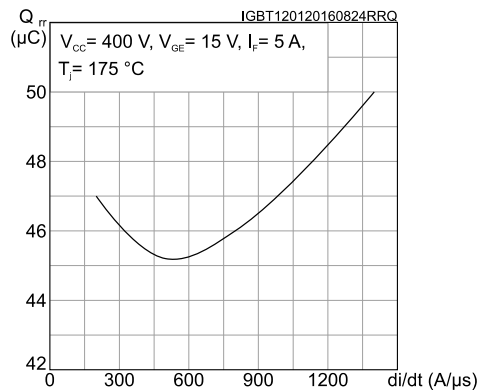
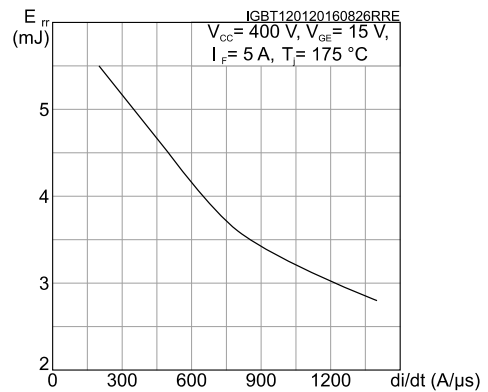

Figure 25: Reverse recovery energy vs. diode current slope



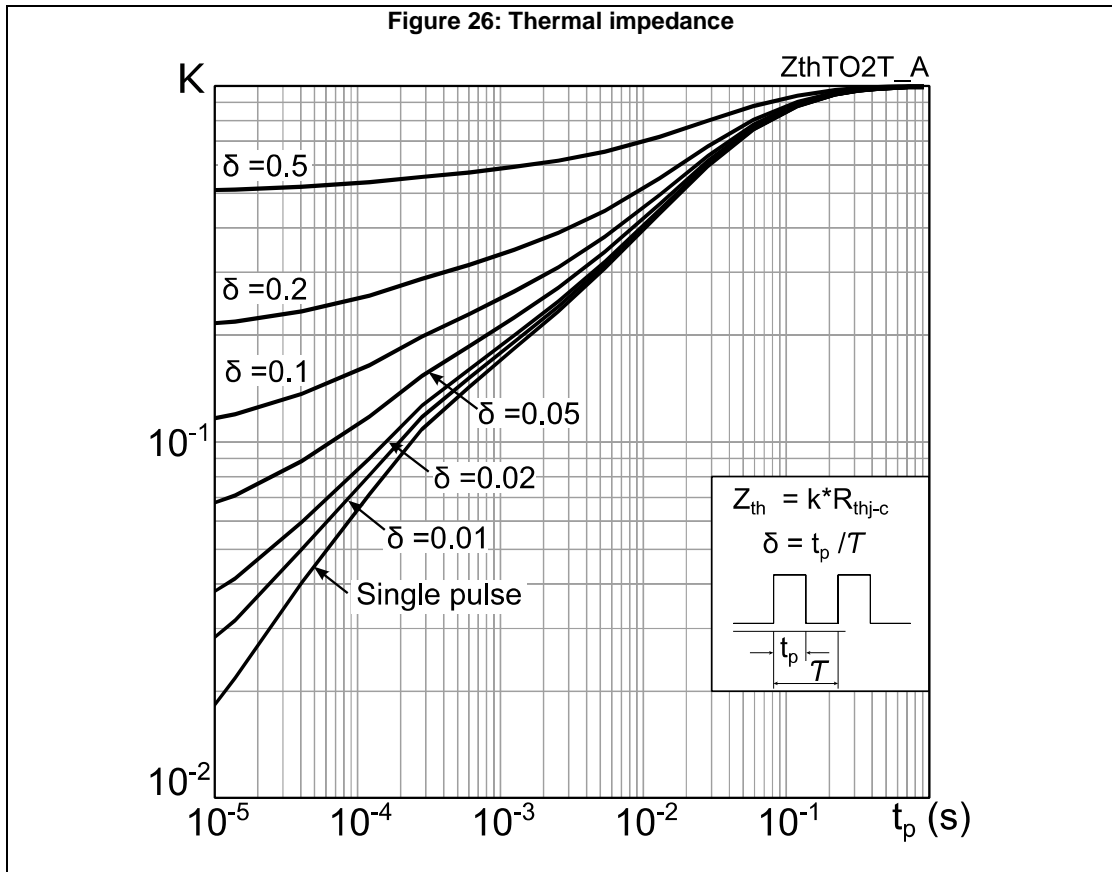
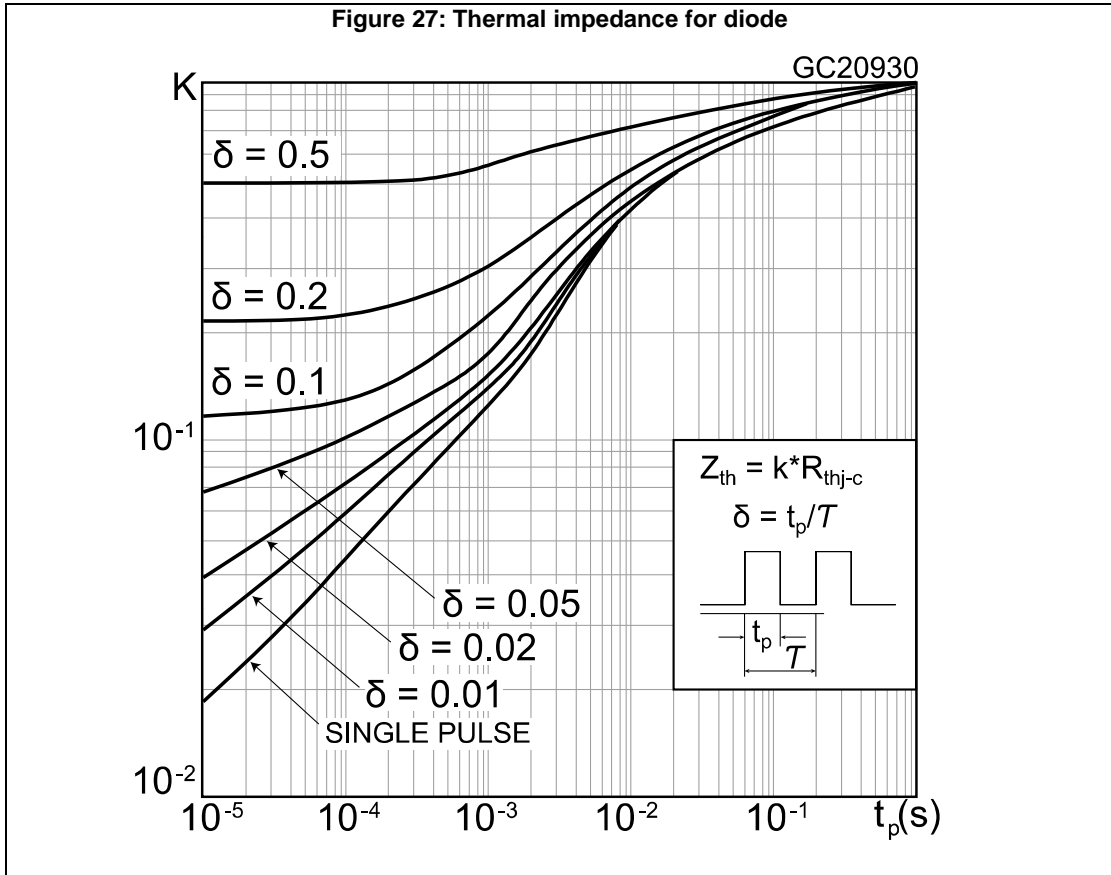
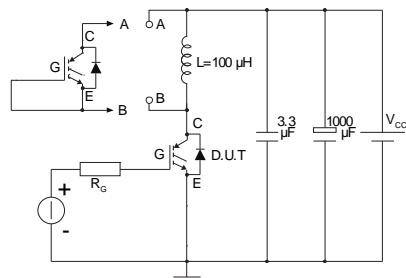

Figure 27: Thermal impedance for diode



3 Test circuits

Figure 28: Test circuit for inductive load switching



AM01504v1

Figure 29: Gate charge test circuit

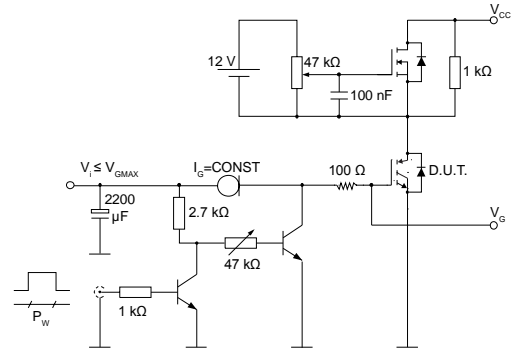

AM01505v1

Figure 30: Switching waveform

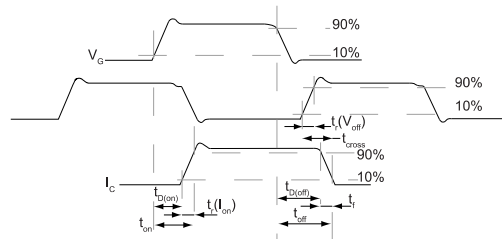

AM01506v1

4 Package information

In order to meet environmental requirements, ST offers these devices in different grades of ECOPACK® packages, depending on their level of environmental compliance. ECOPACK® specifications, grade definitions and product status are available at: www.st.com. ECOPACK® is an ST trademark.

4.1 TO-3P package information

Figure 31: TO-3P package outline

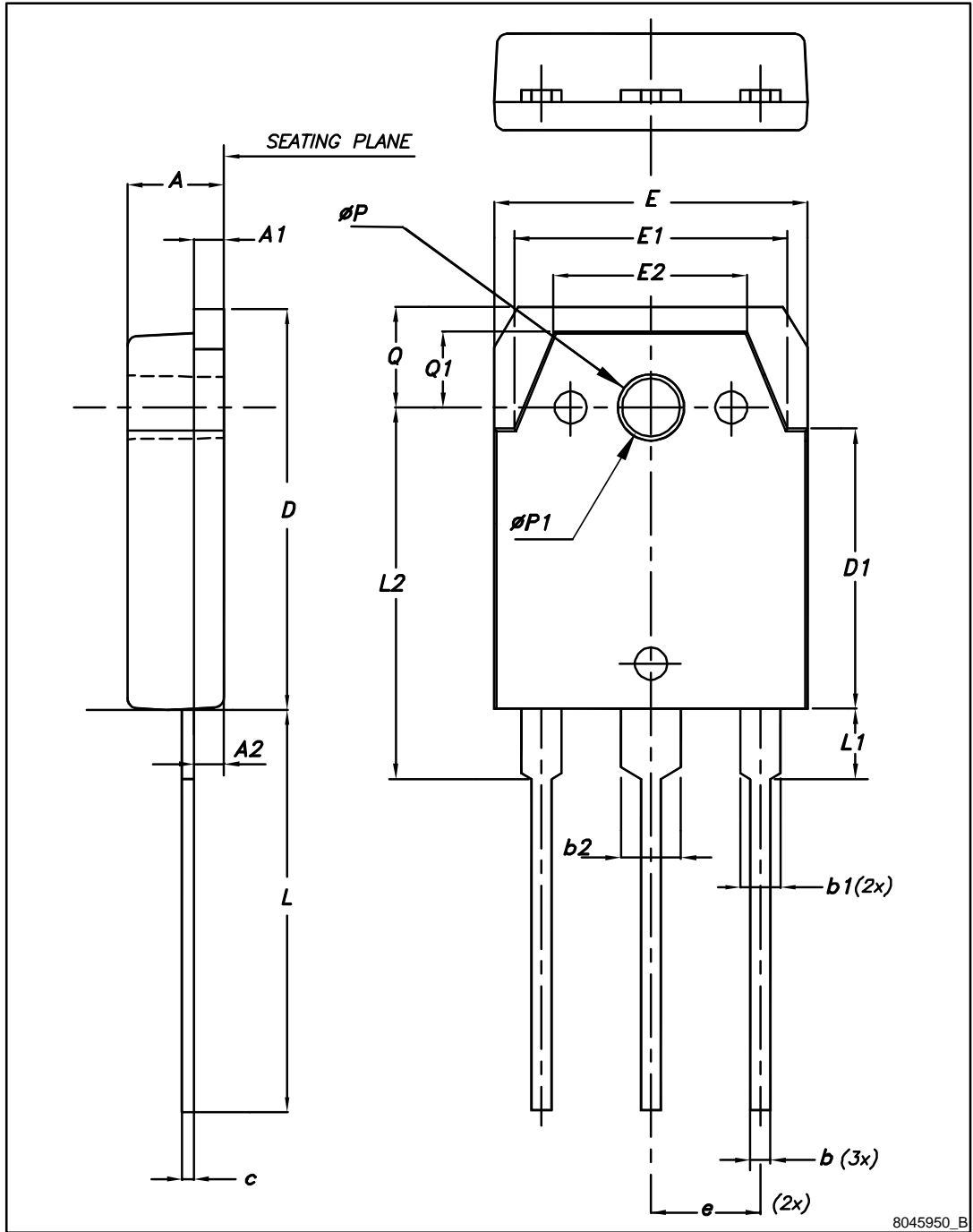

Table 8: TO-3P package mechanical data

Dim.	mm		
	Min.	Typ.	Max.
A	4.60	4.80	5.00
A1	1.45	1.50	1.65
A2	1.20	1.40	1.60
b	0.80	1.00	1.20
b1	1.80	2.00	2.20
b2	2.80	3.00	3.20
c	0.55	0.60	0.75
D	19.70	19.90	20.10
D1	13.70	13.90	14.10
E	15.40	15.60	15.80
E1	13.40	13.60	13.80
E2	9.40	9.60	9.90
e	5.15	5.45	5.75
L	19.80	20.00	20.20
L1	3.30	3.50	3.70
L2	18.20	18.40	18.60
ØP	3.30	3.40	3.50
ØP1	3.10	3.20	3.30
Q	4.80	5.00	5.20
Q1	3.60	3.80	4

5 Revision history

Table 9: Document revision history

Date	Revision	Changes
20-Oct-2015	1	First release.
01-Mar-2016	2	Updated features in cover page. Inserted <i>Section 2.1: "Electrical characteristics (curves)"</i> . Minor text changes
13-Jul-2016	3	Document status promoted from preliminary to production data.

IMPORTANT NOTICE – PLEASE READ CAREFULLY

STMicroelectronics NV and its subsidiaries ("ST") reserve the right to make changes, corrections, enhancements, modifications, and improvements to ST products and/or to this document at any time without notice. Purchasers should obtain the latest relevant information on ST products before placing orders. ST products are sold pursuant to ST's terms and conditions of sale in place at the time of order acknowledgement.

Purchasers are solely responsible for the choice, selection, and use of ST products and ST assumes no liability for application assistance or the design of Purchasers' products.

No license, express or implied, to any intellectual property right is granted by ST herein.

Resale of ST products with provisions different from the information set forth herein shall void any warranty granted by ST for such product.

ST and the ST logo are trademarks of ST. All other product or service names are the property of their respective owners.

Information in this document supersedes and replaces information previously supplied in any prior versions of this document.

© 2016 STMicroelectronics – All rights reserved

X-ON Electronics

Largest Supplier of Electrical and Electronic Components

Click to view similar products for [IGBT Transistors](#) category:

Click to view products by [STMicroelectronics](#) manufacturer:

Other Similar products are found below :

[748152A](#) [APT20GT60BRDQ1G](#) [APT50GT60BRG](#) [NGTB10N60FG](#) [STGFW20V60DF](#) [APT30GP60BG](#) [APT45GR65B2DU30](#)
[GT50JR22\(STA1ES\)](#) [TIG058E8-TL-H](#) [VS-CPV364M4KPBF](#) [NGTB25N120FL2WAG](#) [NGTG40N120FL2WG](#) [RJH60F3DPQ-A0#T0](#)
[APT40GR120B2SCD10](#) [APT15GT120BRG](#) [APT20GT60BRG](#) [NGTB75N65FL2WAG](#) [NGTG15N120FL2WG](#) [IXA30RG1200DHGLB](#)
[IXA40RG1200DHGLB](#) [APT70GR65B2DU40](#) [NTE3320](#) [IHF40N65R5SXXKSA1](#) [APT70GR120J](#) [APT35GP120JDQ2](#)
[IKZA40N65RH5XKSA1](#) [IKFW75N65ES5XKSA1](#) [IKFW50N65ES5XKSA1](#) [IKFW50N65EH5XKSA1](#) [IKFW40N65ES5XKSA1](#)
[IKFW60N65ES5XKSA1](#) [IMBG120R090M1HXTMA1](#) [IMBG120R220M1HXTMA1](#) [XD15H120CX1](#) [XD25H120CX0](#) [XP15PJS120CL1B1](#)
[IGW30N60H3FKSA1](#) [STGWA8M120DF3](#) [IGW08T120FKSA1](#) [IGW75N60H3FKSA1](#) [HGTG40N60B3](#) [FGH60N60SMD_F085](#)
[FGH75T65UPD](#) [STGWA15H120F2](#) [IKA10N60TXKSA1](#) [IHW20N120R5XKSA1](#) [RJH60D2DPP-M0#T2](#) [IKP20N60TXKSA1](#)
[IHW20N65R5XKSA1](#) [IDW40E65D2FKSA1](#)