

# Automotive-grade trench gate field-stop, 650 V, 120 A, low-loss, M series IGBT in a Max247 long leads package

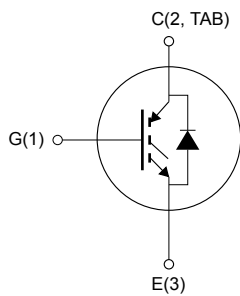
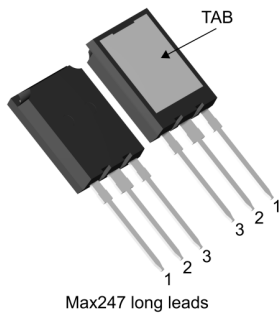

### Product status link

[STGYA120M65DF2AG](#)

### Product summary

Order code	STGYA120M65DF2AG
Marking	G120M65DF2AG
Package	Max247 long leads
Packing	Tube

## Features

- AEC-Q101 qualified 
- 6  $\mu$ s of short-circuit withstand time
- $V_{CE(sat)} = 1.65$  V (typ.) @  $I_C = 120$  A
- Tight parameter distribution
- Safer paralleling
- Positive  $V_{CE(sat)}$  temperature coefficient
- Low thermal resistance
- Soft and very fast recovery antiparallel diode
- Maximum junction temperature:  $T_J = 175$  °C

## Applications

- Motor control
- UPS
- PFC
- General purpose inverters

## Description

This device is an IGBT developed using an advanced proprietary trench gate field-stop structure. The device is part of the M series IGBTs, which represent an optimal balance between inverter system performance and efficiency where the low-loss and the short-circuit functionality is essential. Furthermore, the positive  $V_{CE(sat)}$  temperature coefficient and the tight parameter distribution result in safer paralleling operation.

# 1 Electrical ratings

**Table 1. Absolute maximum ratings**

Symbol	Parameter	Value	Unit
$V_{CES}$	Collector-emitter voltage ( $V_{GE} = 0$ V)	650	V
$I_C^{(1)}$	Continuous collector current at $T_C = 25$ °C	160	A
$I_C$	Continuous collector current at $T_C = 100$ °C	120	
$I_{CP}^{(2)}$	Pulsed collector current	360	A
$V_{GE}$	Gate-emitter voltage	±20	V
$I_F^{(1)}$	Continuous forward current at $T_C = 25$ °C	160	A
$I_F$	Continuous forward current at $T_C = 100$ °C	120	
$I_{FP}^{(2)}$	Pulsed forward current	360	A
$P_{TOT}$	Total power dissipation at $T_C = 25$ °C	625	W
$T_{STG}$	Storage temperature range	-55 to 150	°C
$T_J$	Operating junction temperature range	-55 to 175	

1. Current level is limited by bond wires.
2. Pulse width limited by maximum junction temperature.

**Table 2. Thermal data**

Symbol	Parameter	Value	Unit
$R_{thJC}$	Thermal resistance junction-case IGBT	0.24	°C/W
$R_{thJC}$	Thermal resistance junction-case diode	0.6	
$R_{thJA}$	Thermal resistance junction-ambient	50	

## 2 Electrical characteristics

$T_C = 25\text{ °C}$  unless otherwise specified

**Table 3. Static characteristics**

Symbol	Parameter	Test conditions	Min.	Typ.	Max.	Unit
$V_{(BR)CES}$	Collector-emitter breakdown voltage	$V_{GE} = 0\text{ V}, I_C = 250\text{ }\mu\text{A}$	650			V
$V_{CE(sat)}$	Collector-emitter saturation voltage	$V_{GE} = 15\text{ V}, I_C = 120\text{ A}$		1.65	2.15	V
		$V_{GE} = 15\text{ V}, I_C = 120\text{ A}, T_J = 125\text{ °C}$		1.95		
		$V_{GE} = 15\text{ V}, I_C = 120\text{ A}, T_J = 175\text{ °C}$		2.1		
$V_F$	Forward on-voltage	$I_F = 120\text{ A}$		1.9	2.6	V
		$I_F = 120\text{ A}, T_J = 125\text{ °C}$		1.7		
		$I_F = 120\text{ A}, T_J = 175\text{ °C}$		1.6		
$V_{GE(th)}$	Gate threshold voltage	$V_{CE} = V_{GE}, I_C = 2\text{ mA}$	5	6	7	V
$I_{CES}$	Collector cut-off current	$V_{GE} = 0\text{ V}, V_{CE} = 650\text{ V}$			100	$\mu\text{A}$
$I_{GES}$	Gate-emitter leakage current	$V_{CE} = 0\text{ V}, V_{GE} = \pm 20\text{ V}$			$\pm 250$	$\mu\text{A}$

**Table 4. Dynamic characteristics**

Symbol	Parameter	Test conditions	Min.	Typ.	Max.	Unit
$C_{ies}$	Input capacitance	$V_{CE} = 25\text{ V}, f = 1\text{ MHz}, V_{GE} = 0\text{ V}$	-	11000	-	pF
$C_{oes}$	Output capacitance		-	610	-	
$C_{res}$	Reverse transfer capacitance		-	250	-	
$Q_g$	Total gate charge	$V_{CC} = 520\text{ V}, I_C = 120\text{ A},$ $V_{GE} = 0\text{ to }15\text{ V}$ (see Figure 30. Gate charge test circuit)	-	420	-	nC
$Q_{ge}$	Gate-emitter charge		-	90	-	
$Q_{gc}$	Gate-collector charge		-	160	-	

**Table 5. IGBT switching characteristics (inductive load)**

Symbol	Parameter	Test conditions	Min.	Typ.	Max.	Unit	
$t_{d(on)}$	Turn-on delay time	$V_{CE} = 400\text{ V}$ , $I_C = 120\text{ A}$ , $V_{GE} = 15\text{ V}$ , $R_G = 4.7\ \Omega$ (see Figure 29. Test circuit for inductive load switching)		66	-	ns	
$t_r$	Current rise time			38	-	ns	
$(di/dt)_{on}$	Turn-on current slope			2500	-	A/ $\mu$ s	
$t_{d(off)}$	Turn-off-delay time			185	-	ns	
$t_f$	Current fall time			85	-	ns	
$E_{on}^{(1)}$	Turn-on switching energy			1.8	-	mJ	
$E_{off}^{(2)}$	Turn-off switching energy			4.41	-	mJ	
$E_{ts}$	Total switching energy			6.21	-	mJ	
$t_{d(on)}$	Turn-on delay time		$V_{CE} = 400\text{ V}$ , $I_C = 120\text{ A}$ , $V_{GE} = 15\text{ V}$ , $R_G = 4.7\ \Omega$ , $T_J = 175\text{ }^\circ\text{C}$ (see Figure 29. Test circuit for inductive load switching)		62	-	ns
$t_r$	Current rise time				48	-	ns
$(di/dt)_{on}$	Turn-on current slope			2016	-	A/ $\mu$ s	
$t_{d(off)}$	Turn-off-delay time			187	-	ns	
$t_f$	Current fall time			164	-	ns	
$E_{on}^{(1)}$	Turn-on switching energy			4.4	-	mJ	
$E_{off}^{(2)}$	Turn-off switching energy			6.0	-	mJ	
$E_{ts}$	Total switching energy		10.4	-	mJ		
$t_{sc}$	Short-circuit withstand time	$V_{CC} \leq 400\text{ V}$ , $V_{GE} = 13\text{ V}$ , $T_{Jstart} = 150\text{ }^\circ\text{C}$	10		-	$\mu$ s	
		$V_{CC} \leq 400\text{ V}$ , $V_{GE} = 15\text{ V}$ , $T_{Jstart} = 150\text{ }^\circ\text{C}$	6		-		

1. Including the reverse recovery of the diode.

2. Including the tail of the collector current.

**Table 6. Diode switching characteristics (inductive load)**

Symbol	Parameter	Test conditions	Min.	Typ.	Max.	Unit	
$t_{rr}$	Reverse recovery time	$I_F = 120\text{ A}$ , $V_R = 400\text{ V}$ , $V_{GE} = 15\text{ V}$ , $di/dt = 1000\text{ A}/\mu\text{s}$ (see Figure 29. Test circuit for inductive load switching)	-	202	-	ns	
$Q_{rr}$	Reverse recovery charge			-	2.9	-	$\mu$ C
$I_{rrm}$	Reverse recovery current			-	32.5	-	A
$dI_{rr}/dt$	Peak rate of fall of reverse recovery current during $t_b$			-	500	-	A/ $\mu$ s
$E_{rr}$	Reverse recovery energy			-	500	-	$\mu$ J
$t_{rr}$	Reverse recovery time	$I_F = 120\text{ A}$ , $V_R = 400\text{ V}$ , $V_{GE} = 15\text{ V}$ , $di/dt = 1000\text{ A}/\mu\text{s}$ , $T_J = 175\text{ }^\circ\text{C}$ (see Figure 29. Test circuit for inductive load switching)	-	320	-	ns	
$Q_{rr}$	Reverse recovery charge			-	11.2	-	$\mu$ C
$I_{rrm}$	Reverse recovery current			-	62	-	A
$dI_{rr}/dt$	Peak rate of fall of reverse recovery current during $t_b$			-	270	-	A/ $\mu$ s
$E_{rr}$	Reverse recovery energy			-	1710	-	$\mu$ J

## 2.1 Electrical characteristics (curves)

**Figure 1. Power dissipation vs case temperature**

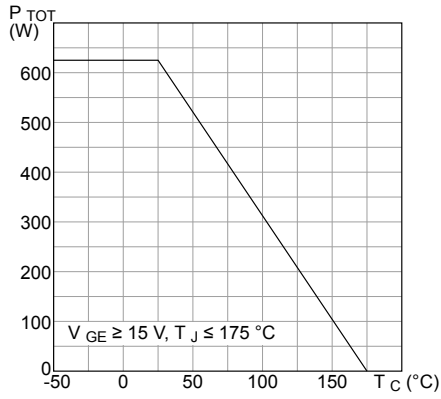

**Figure 2. Collector current vs case temperature**

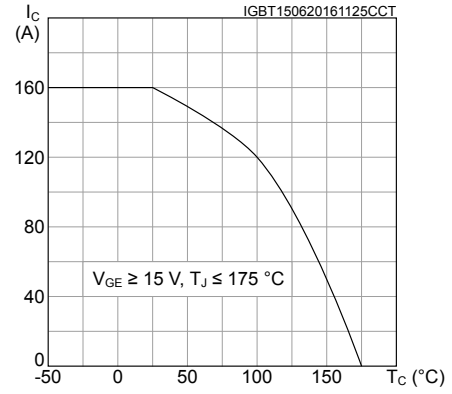

**Figure 3. Output characteristics (T<sub>J</sub> = 25 °C)**

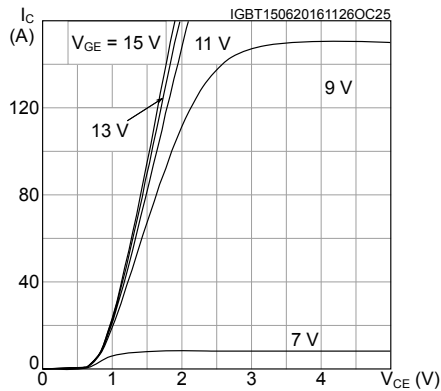

**Figure 4. Output characteristics (T<sub>J</sub> = 175 °C)**

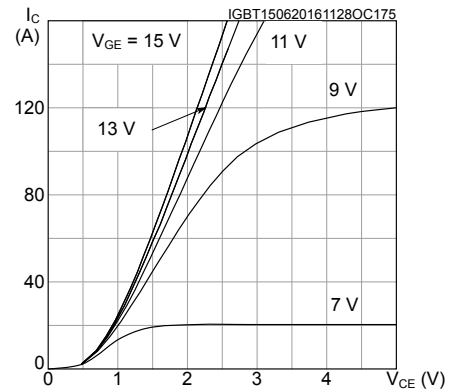

**Figure 5. V<sub>CE(sat)</sub> vs junction temperature**

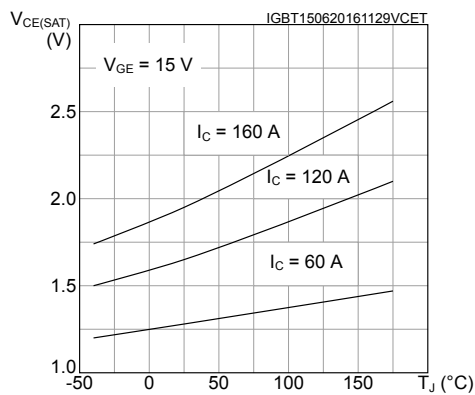

**Figure 6. V<sub>CE(sat)</sub> vs collector current**

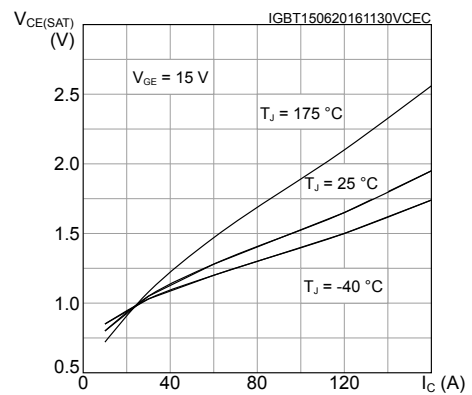

**Figure 7. Collector current vs switching frequency**

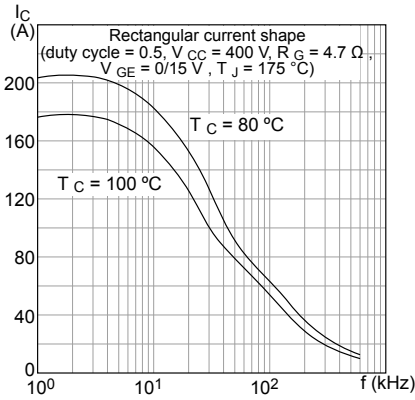

**Figure 8. Forward bias safe operating area**

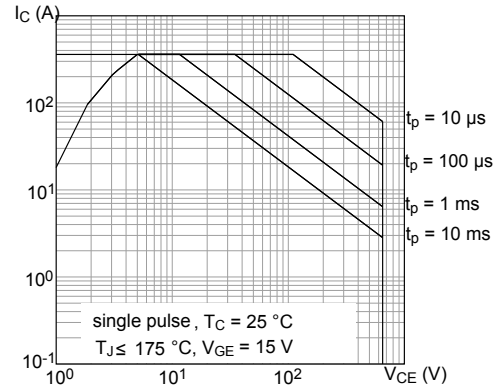

**Figure 9. Transfer characteristics**

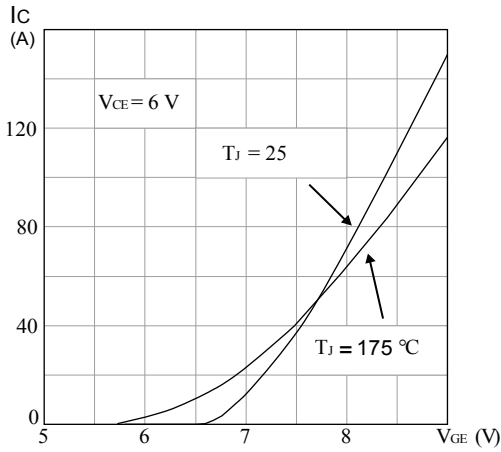

**Figure 10. Diode V<sub>F</sub> vs forward current**

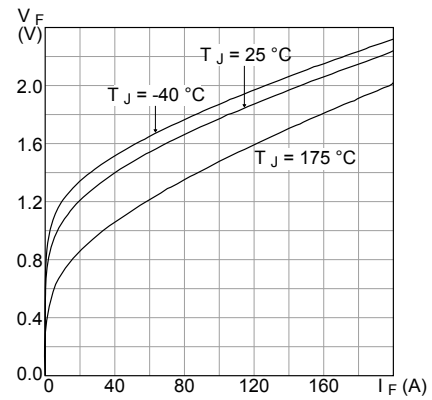

**Figure 11. Normalized V<sub>GE(th)</sub> vs junction temperature**

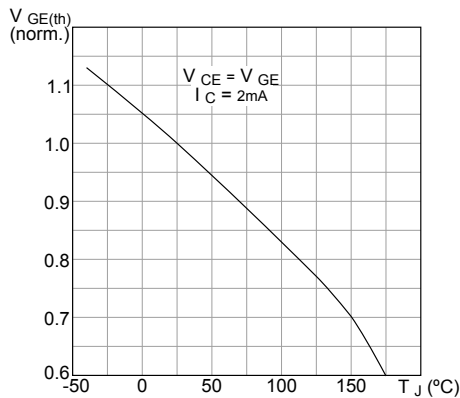

**Figure 12. Normalized V<sub>(BR)CES</sub> vs junction temperature**

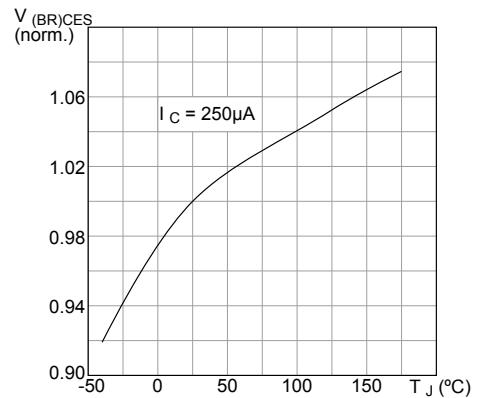

**Figure 13. Capacitance variations**

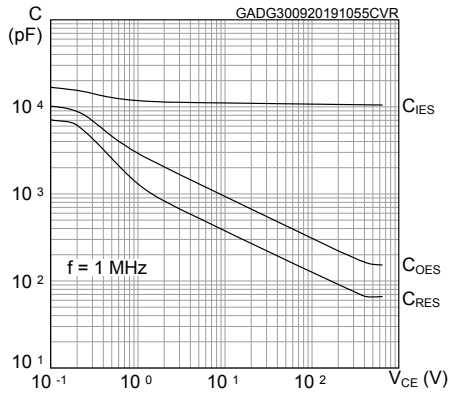

**Figure 14. Gate charge vs gate-emitter voltage**

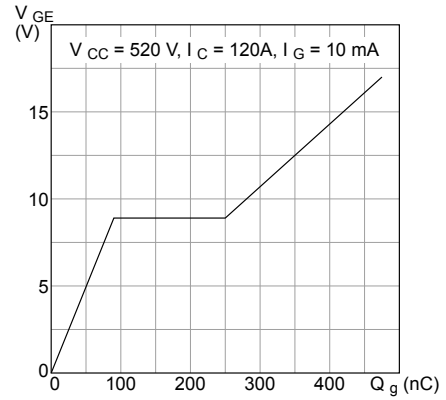

**Figure 15. Switching energy vs collector current**

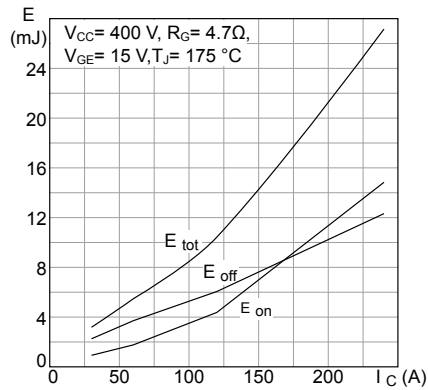

**Figure 16. Switching energy vs gate resistance**

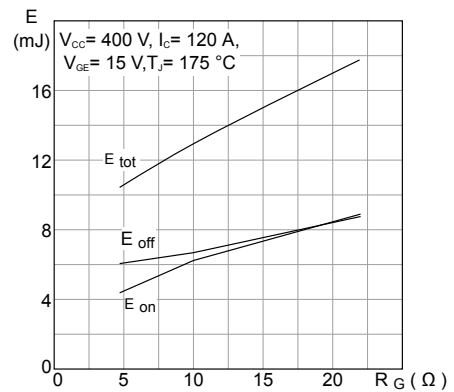

**Figure 17. Switching energy vs temperature**

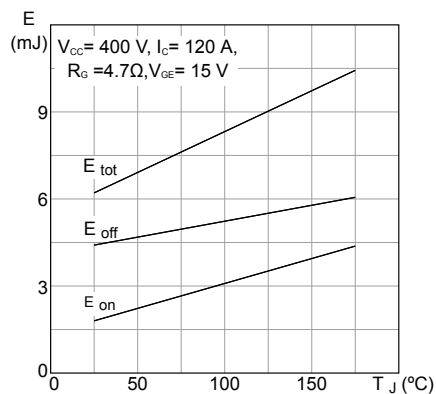

**Figure 18. Switching energy vs collector emitter voltage**

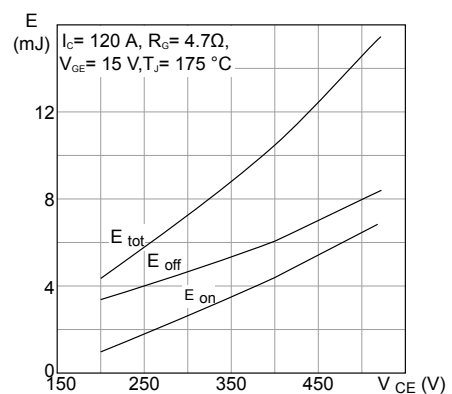

**Figure 19. Short circuit time and current vs  $V_{GE}$**

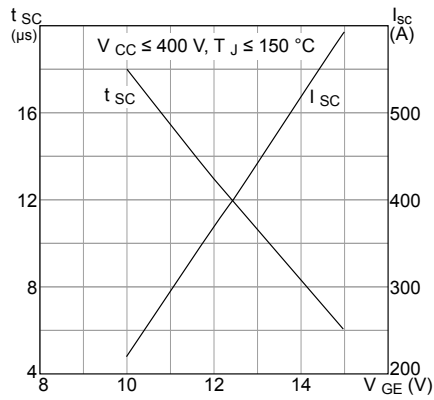

**Figure 20. Switching times vs collector current**

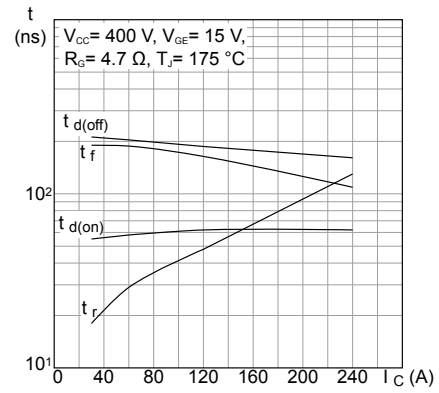

**Figure 21. Switching times vs gate resistance**

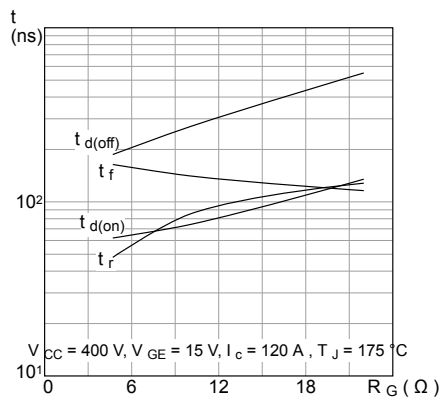

**Figure 22. Reverse recovery current vs diode current slope**

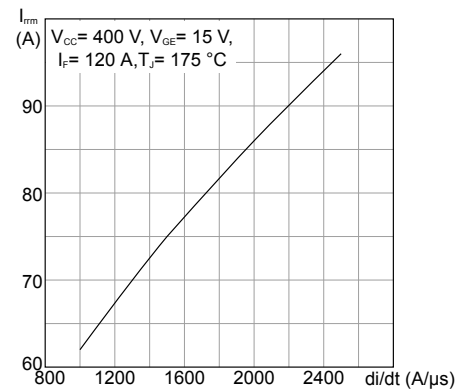

**Figure 23. Reverse recovery time vs diode current slope**

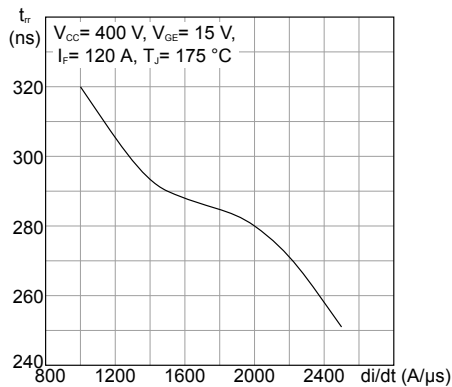

**Figure 24. Reverse recovery charge vs diode current slope**

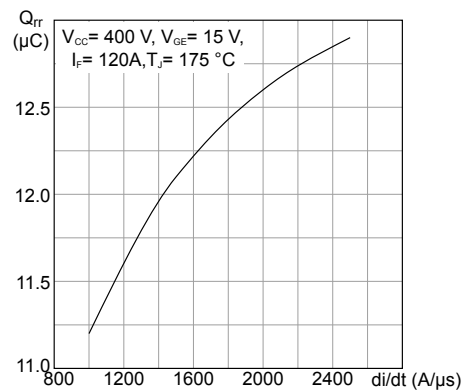



Figure 25. Reverse recovery energy vs diode current slope

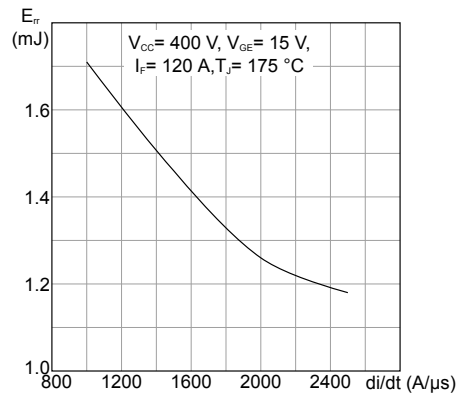

Figure 26. Thermal impedance for IGBT

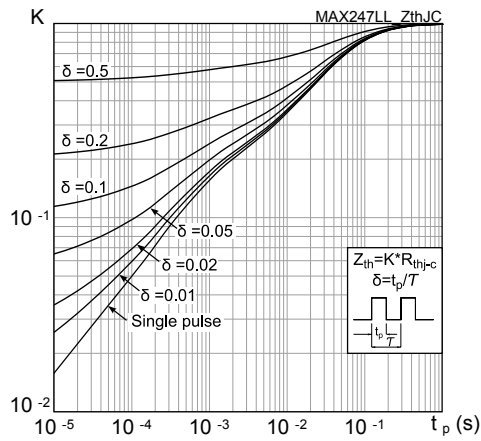
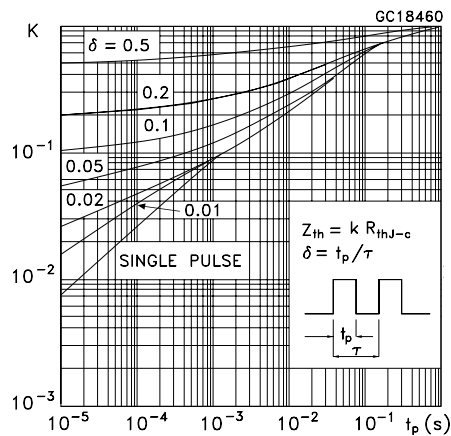
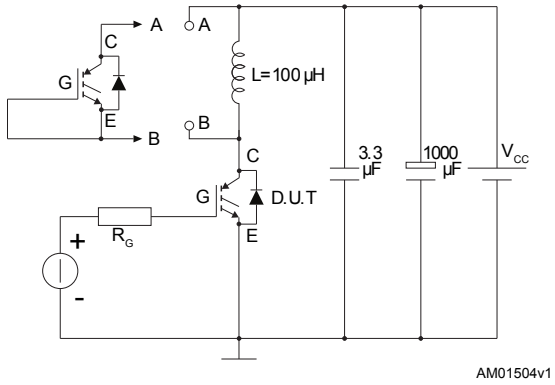
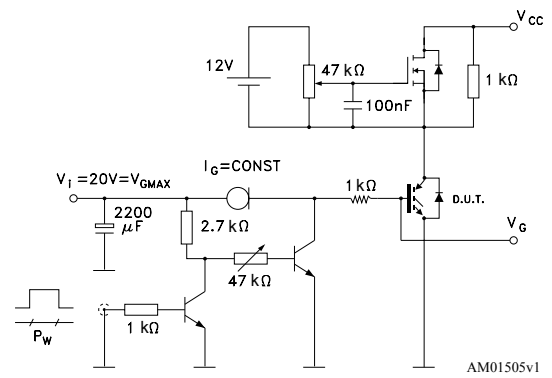
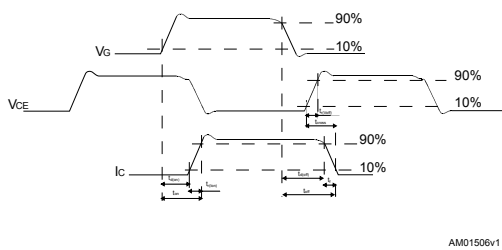
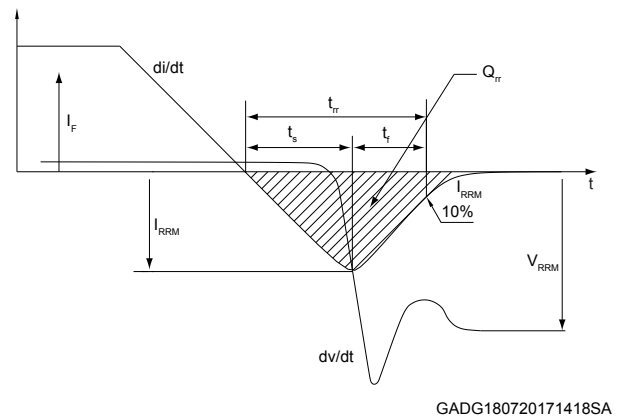

Figure 27. Thermal impedance for diode



### 3 Test circuits

**Figure 28. Test circuit for inductive load switching**

**Figure 29. Gate charge test circuit**

**Figure 30. Switching waveform**

**Figure 31. Diode reverse recovery waveform**

## 4 Package information

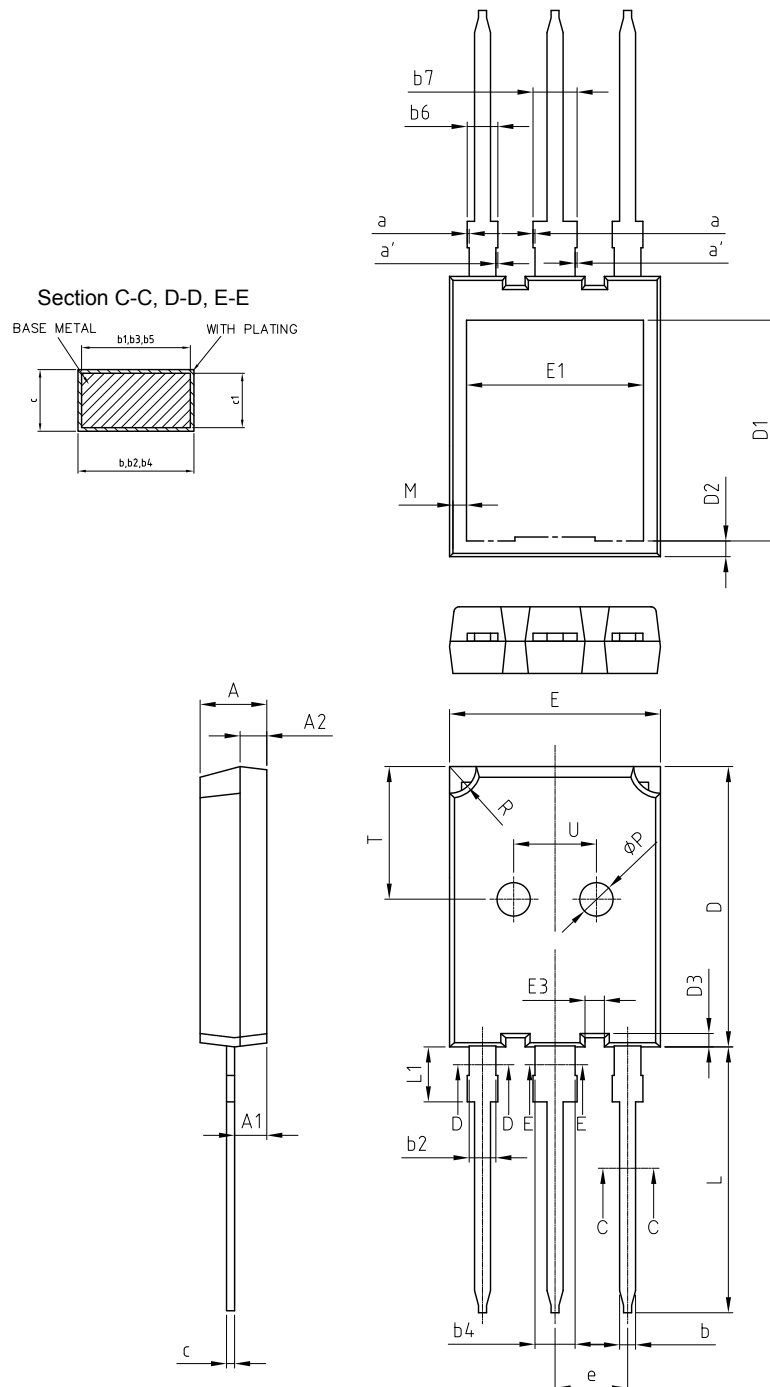
In order to meet environmental requirements, ST offers these devices in different grades of **ECOPACK** packages, depending on their level of environmental compliance. ECOPACK specifications, grade definitions and product status are available at: [www.st.com](http://www.st.com). ECOPACK is an ST trademark.

### 4.1 Max247 long leads package information

**Figure 32. Max247 long leads package outline**



DM00176969\_rev\_1

**Table 7. Max247 long leads package mechanical data**

Dim.	mm		
	Min.	Typ.	Max.
A	4.90	5.00	5.10
A1	2.31	2.41	2.51
A2	1.90	2.00	2.10
a	0		0.15
a'	0		0.15
b	1.16		1.26
b1	1.15	1.20	1.22
b2	1.96		2.06
b3	1.95	2.00	2.02
b4	2.96		3.06
b5	2.95	3.00	3.02
b6			2.25
b7			3.25
c	0.59		0.66
c1	0.58	0.60	0.62
D	20.90	21.00	21.10
D1	16.25	16.55	16.85
D2	1.05	1.17	1.35
D3	0.75	1.00	1.25
E	15.70	15.80	15.90
E1	13.10	13.26	13.50
E3	1.35	1.45	1.55
e	5.34	5.44	5.54
L	19.80	19.92	20.10
L1			4.30
M	0.70		1.30
P	2.40	2.50	2.60
R	1.90	2.00	2.10
T	9.80		10.20
U	6.00		6.40

## Revision history

**Table 8. Document revision history**

Date	Revision	Changes
12-Aug-2016	1	First release.
12-Dec-2016	2	Document status promoted from preliminary to production data. Minor text changes.
24-Aug-2017	3	Updated features and title in cover page. Updated <i>Table 4: "Static characteristics"</i> . Minor text changes.
08-Oct-2019	4	Updated <a href="#">Table 4. Dynamic characteristics</a> . Updated <a href="#">Figure 9. Forward bias safe operating area</a> and <a href="#">Figure 14. Capacitance variations</a> . Minor text changes

**IMPORTANT NOTICE – PLEASE READ CAREFULLY**

STMicroelectronics NV and its subsidiaries (“ST”) reserve the right to make changes, corrections, enhancements, modifications, and improvements to ST products and/or to this document at any time without notice. Purchasers should obtain the latest relevant information on ST products before placing orders. ST products are sold pursuant to ST’s terms and conditions of sale in place at the time of order acknowledgement.

Purchasers are solely responsible for the choice, selection, and use of ST products and ST assumes no liability for application assistance or the design of Purchasers’ products.

No license, express or implied, to any intellectual property right is granted by ST herein.

Resale of ST products with provisions different from the information set forth herein shall void any warranty granted by ST for such product.

ST and the ST logo are trademarks of ST. For additional information about ST trademarks, please refer to [www.st.com/trademarks](http://www.st.com/trademarks). All other product or service names are the property of their respective owners.

Information in this document supersedes and replaces information previously supplied in any prior versions of this document.

© 2019 STMicroelectronics – All rights reserved

## X-ON Electronics

Largest Supplier of Electrical and Electronic Components

*Click to view similar products for [IGBT Transistors](#) category:*

*Click to view products by [STMicroelectronics](#) manufacturer:*

Other Similar products are found below :

[748152A](#) [APT20GT60BRDQ1G](#) [APT50GT60BRG](#) [NGTB10N60FG](#) [STGFW20V60DF](#) [APT30GP60BG](#) [APT45GR65B2DU30](#)  
[GT50JR22\(STA1ES\)](#) [TIG058E8-TL-H](#) [VS-CPV364M4KPBF](#) [NGTB25N120FL2WAG](#) [NGTG40N120FL2WG](#) [RJH60F3DPQ-A0#T0](#)  
[APT40GR120B2SCD10](#) [APT15GT120BRG](#) [APT20GT60BRG](#) [NGTB75N65FL2WAG](#) [NGTG15N120FL2WG](#) [IXA30RG1200DHGLB](#)  
[IXA40RG1200DHGLB](#) [APT70GR65B2DU40](#) [NTE3320](#) [IHF40N65R5SXXKSA1](#) [APT70GR120J](#) [APT35GP120JDQ2](#)  
[IKZA40N65RH5XKSA1](#) [IKFW75N65ES5XKSA1](#) [IKFW50N65ES5XKSA1](#) [IKFW50N65EH5XKSA1](#) [IKFW40N65ES5XKSA1](#)  
[IKFW60N65ES5XKSA1](#) [IMBG120R090M1HXTMA1](#) [IMBG120R220M1HXTMA1](#) [XD15H120CX1](#) [XD25H120CX0](#) [XP15PJS120CL1B1](#)  
[IGW30N60H3FKSA1](#) [STGWA8M120DF3](#) [IGW08T120FKSA1](#) [IGW75N60H3FKSA1](#) [HGTG40N60B3](#) [FGH60N60SMD\\_F085](#)  
[FGH75T65UPD](#) [STGWA15H120F2](#) [IKA10N60TXKSA1](#) [IHW20N120R5XKSA1](#) [RJH60D2DPP-M0#T2](#) [IKP20N60TXKSA1](#)  
[IHW20N65R5XKSA1](#) [IDW40E65D2FKSA1](#)