

N-channel 650 V, 0.215 Ω typ., 12.5 A MDmesh™ V Power MOSFET in a PowerFLAT™ 8x8 HV package

Datasheet - production data

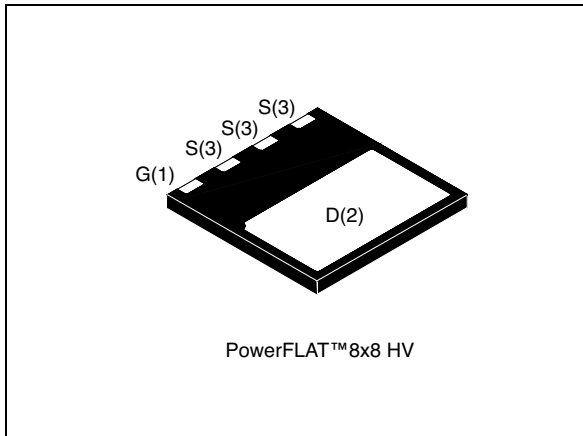
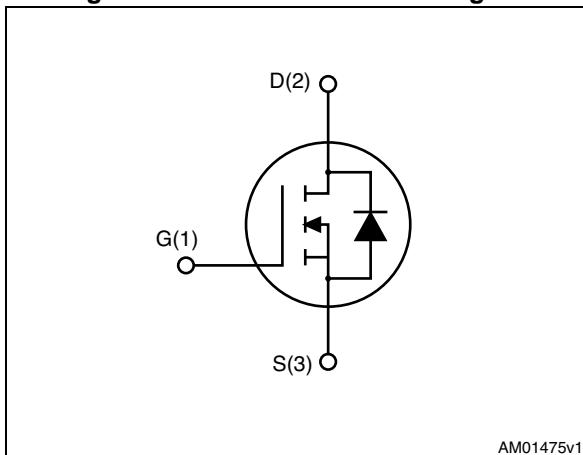

Figure 1. Internal schematic diagram



Features

Order code	V _{DS}	R _{DS(on)max.}	I _D
STL19N65M5	710 V	0.240 Ω	12.5 A ⁽¹⁾

1. The value is rated according to R_{thj-case} and limited by package.

- Worldwide best R_{DS(on)} * area
- Higher V_{DSS} rating and high dv/dt capability
- Excellent switching performance

Applications

- Switching applications

Description

This device is an N-channel MDmesh™ V Power MOSFET based on an innovative proprietary vertical process technology, which is combined with STMicroelectronics' well-known PowerMESH™ horizontal layout structure. The resulting product has extremely low on-resistance, which is unmatched among silicon-based Power MOSFETs, making it especially suitable for applications which require superior power density and outstanding efficiency.

Table 1. Device summary

Order code	Marking	Package	Packaging
STL19N65M5	19N65M5	PowerFLAT™ 8x8 HV	Tape and reel

Contents

1	Electrical ratings	3
2	Electrical characteristics	4
	2.1 Electrical characteristics (curves)	6
3	Test circuits	9
4	Package mechanical data	10
5	Packaging mechanical data	14
6	Revision history	16



1 Electrical ratings

Table 2. Absolute maximum ratings

Symbol	Parameter	Value	Unit
V_{DS}	Drain-source voltage	650	V
V_{GS}	Gate-source voltage	± 25	V
$I_D^{(1)}$	Drain current (continuous) at $T_C = 25\text{ }^\circ\text{C}$	12.5	A
$I_D^{(1)}$	Drain current (continuous) at $T_C = 100\text{ }^\circ\text{C}$	8.3	A
$I_{DM}^{(1),(2)}$	Drain current (pulsed)	50	A
$I_D^{(3)}$	Drain current (continuous) at $T_{amb} = 25\text{ }^\circ\text{C}$	2.3	A
$I_D^{(3)}$	Drain current (continuous) at $T_{amb} = 100\text{ }^\circ\text{C}$	1.5	A
$P_{TOT}^{(3)}$	Total dissipation at $T_{amb} = 25\text{ }^\circ\text{C}$	2.8	W
$P_{TOT}^{(1)}$	Total dissipation at $T_C = 25\text{ }^\circ\text{C}$	90	W
I_{AR}	Avalanche current, repetitive or not-repetitive (pulse width limited by T_j max)	4	A
E_{AS}	Single pulse avalanche energy (starting $T_j = 25\text{ }^\circ\text{C}$, $I_D = I_{AR}$, $V_{DD} = 50\text{ V}$)	210	mJ
$dv/dt^{(4)}$	Peak diode recovery voltage slope	15	V/ns
T_{stg}	Storage temperature	- 55 to 150	$^\circ\text{C}$
T_j	Max. operating junction temperature	150	$^\circ\text{C}$

1. The value is rated according to $R_{thj-case}$ and limited by package.
2. Pulse width limited by safe operating area.
3. When mounted on FR-4 board of inch^2 , 2oz Cu
4. $I_{SD} \leq 12.5\text{ A}$, $di/dt \leq 400\text{ A}/\mu\text{s}$, $V_{Peak} \leq V_{(BR)DSS}$, $V_{DD} = 400\text{ V}$.

Table 3. Thermal data

Symbol	Parameter	Value	Unit
$R_{thj-case}$	Thermal resistance junction-case max	1.39	$^\circ\text{C}/\text{W}$
$R_{thj-amb}$	Thermal resistance junction-amb max	45	$^\circ\text{C}/\text{W}$

2 Electrical characteristics

($T_C = 25\text{ °C}$ unless otherwise specified)

Table 4. On /off states

Symbol	Parameter	Test conditions	Min.	Typ.	Max.	Unit
$V_{(BR)DSS}$	Drain-source breakdown voltage ($V_{GS} = 0$)	$I_D = 1\text{ mA}$	650			V
I_{DSS}	Zero gate voltage drain current ($V_{GS} = 0$)	$V_{DS} = 650\text{ V}$ $V_{DS} = 650\text{ V}, T_C = 125\text{ °C}$			1 100	μA μA
I_{GSS}	Gate-body leakage current ($V_{DS} = 0$)	$V_{GS} = \pm 25\text{ V}$			± 100	nA
$V_{GS(th)}$	Gate threshold voltage	$V_{DS} = V_{GS}, I_D = 250\text{ }\mu\text{A}$	3	4	5	V
$R_{DS(on)}$	Static drain-source on-resistance	$V_{GS} = 10\text{ V}, I_D = 7.5\text{ A}$		0.215	0.240	Ω

Table 5. Dynamic

Symbol	Parameter	Test conditions	Min.	Typ.	Max.	Unit
C_{iss}	Input capacitance	$V_{DS} = 100\text{ V}, f = 1\text{ MHz},$ $V_{GS} = 0$	-	1240	-	pF
C_{oss}	Output capacitance		-	32	-	pF
C_{rss}	Reverse transfer capacitance		-	3	-	pF
$C_{o(er)}^{(1)}$	Equivalent output capacitance energy related	$V_{GS} = 0,$ $V_{DS} = 0\text{ to }80\% V_{(BR)DSS}$	-	30	-	pF
$C_{o(tr)}^{(2)}$	Equivalent capacitance time related		-	99	-	pF
R_G	Intrinsic gate resistance	$f = 1\text{ MHz open drain}$	-	3	-	Ω
Q_g	Total gate charge	$V_{DD} = 520\text{ V}, I_D = 7.5\text{ A},$ $V_{GS} = 10\text{ V}$ (see Figure 16)	-	31	-	nC
Q_{gs}	Gate-source charge		-	8	-	nC
Q_{gd}	Gate-drain charge		-	14	-	nC

- $C_{oss\text{ eq}}$ time related is defined as a constant equivalent capacitance giving the same charging time as C_{oss} when V_{DS} increases from 0 to 80% V_{DSS}
- $C_{oss\text{ eq}}$ energy related is defined as a constant equivalent capacitance giving the same stored energy as C_{oss} when V_{DS} increases from 0 to 80% V_{DSS}

Table 6. Switching times

Symbol	Parameter	Test conditions	Min.	Typ.	Max.	Unit
$t_{d(v)}$	Voltage delay time	$V_{DD} = 400\text{ V}$, $I_D = 9.5\text{ A}$, $R_G = 4.7\ \Omega$, $V_{GS} = 10\text{ V}$ (see Figure 17 and 20)	-	36	-	ns
$t_{r(v)}$	Voltage rise time		-	7	-	ns
$t_{f(i)}$	Current fall time		-	9	-	ns
$t_{c(off)}$	Crossing time		-	11	-	ns

Table 7. Source drain diode

Symbol	Parameter	Test conditions	Min.	Typ.	Max.	Unit
$I_{SD}^{(1)}$	Source-drain current		-		12.5	A
$I_{SDM}^{(1),(2)}$	Source-drain current (pulsed)		-		50	A
$V_{SD}^{(3)}$	Forward on voltage	$I_{SD} = 15\text{ A}$, $V_{GS} = 0$	-		1.5	V
t_{rr}	Reverse recovery time	$I_{SD} = 15\text{ A}$, $di/dt = 100\text{ A}/\mu\text{s}$ $V_{DD} = 100\text{ V}$ (see Figure 17)	-	290		ns
Q_{rr}	Reverse recovery charge		-	3.4		μC
I_{RRM}	Reverse recovery current		-	23.5		A
t_{rr}	Reverse recovery time	$I_{SD} = 15\text{ A}$, $di/dt = 100\text{ A}/\mu\text{s}$ $V_{DD} = 100\text{ V}$, $T_j = 150\text{ }^\circ\text{C}$ (see Figure 17)	-	352		ns
Q_{rr}	Reverse recovery charge		-	4		μC
I_{RRM}	Reverse recovery current		-	24		A

1. The value is rated according to $R_{thj-case}$ and limited by package.
2. Pulse width limited by safe operating area
3. Pulsed: pulse duration = $300\ \mu\text{s}$, duty cycle 1.5%

2.1 Electrical characteristics (curves)

Figure 2. Safe operating area

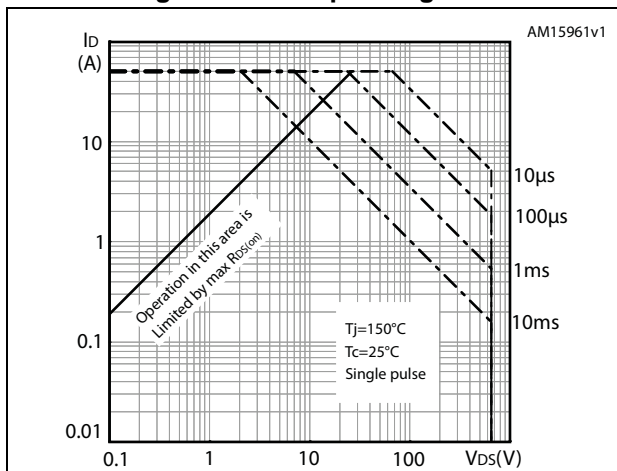

Figure 3. Thermal impedance

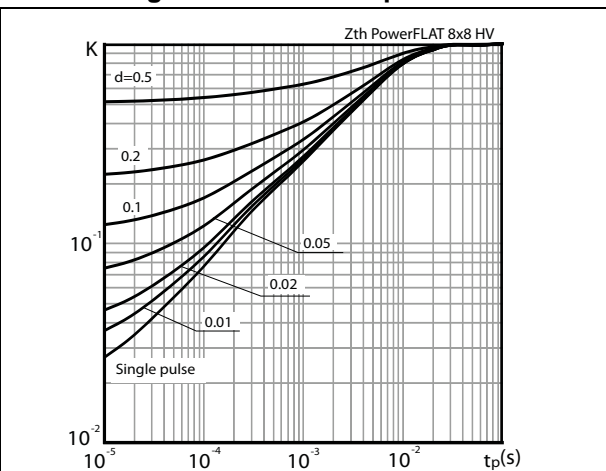

Figure 4. Output characteristics

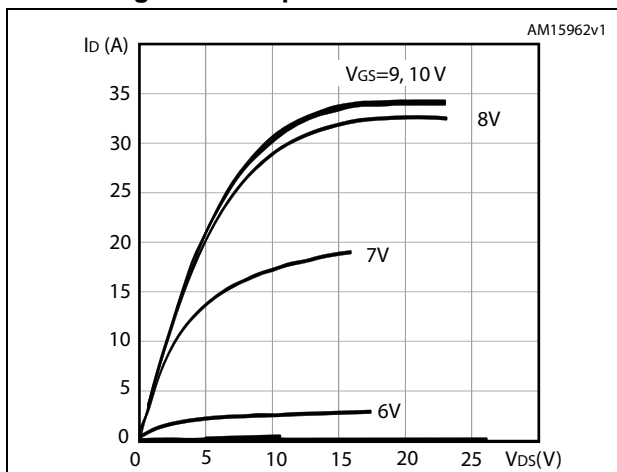

Figure 5. Transfer characteristics

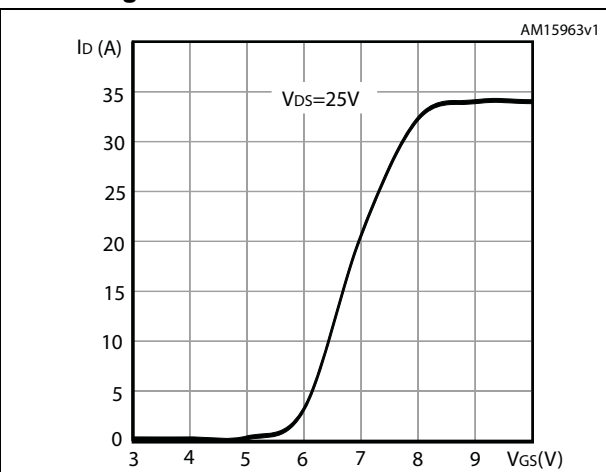

Figure 6. Gate charge vs gate-source voltage

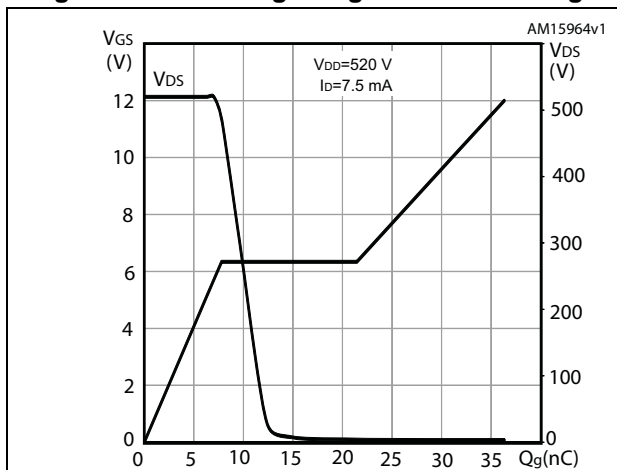

Figure 7. Static drain-source on-resistance

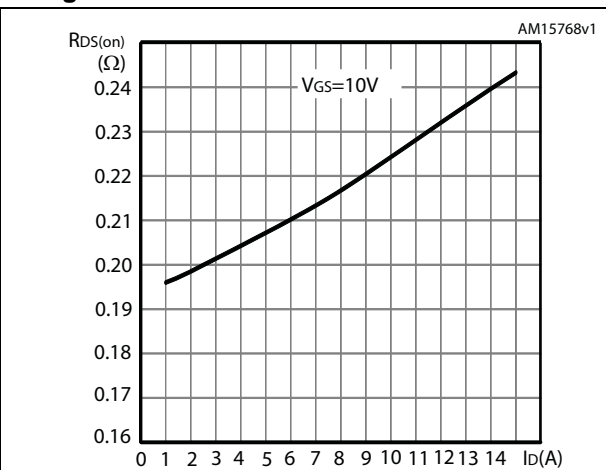

Figure 8. Capacitance variations

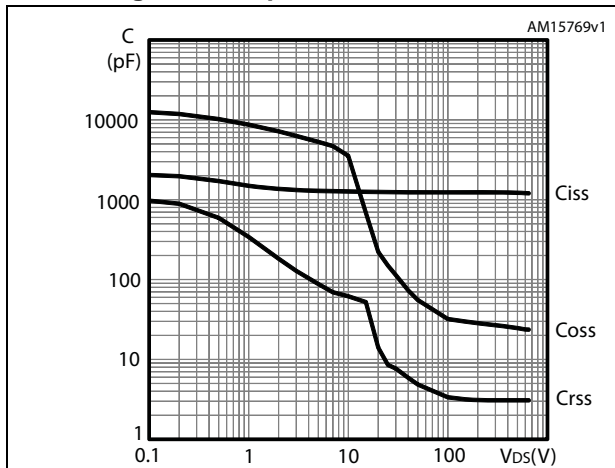

Figure 9. Output capacitance stored energy

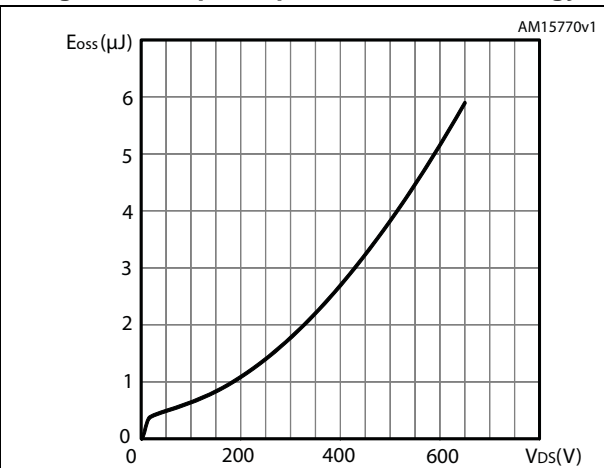

Figure 10. Normalized gate threshold voltage vs. temperature

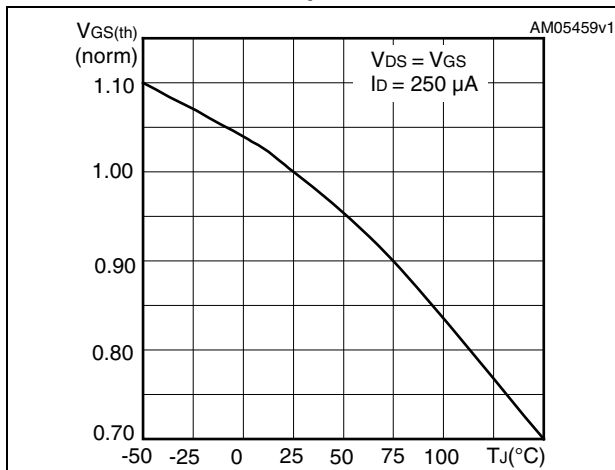

Figure 11. Normalized on-resistance vs. temperature

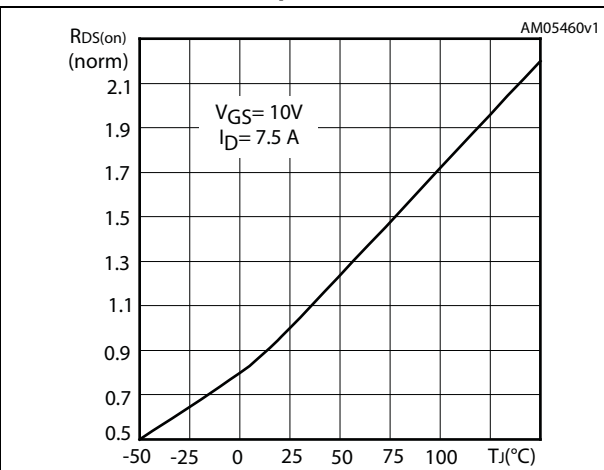

Figure 12. Drain-source diode forward characteristics

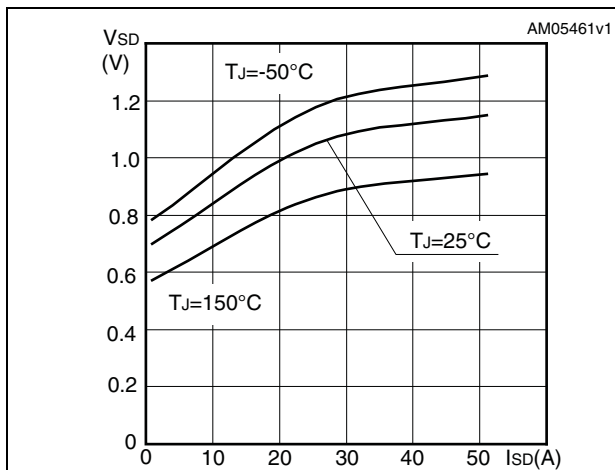

Figure 13. Normalized VDS vs. temperature

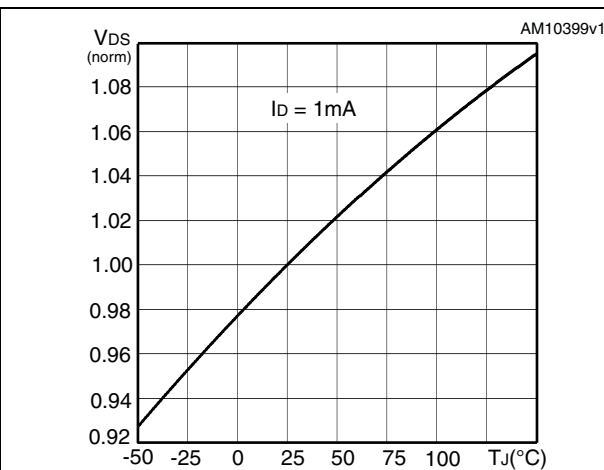
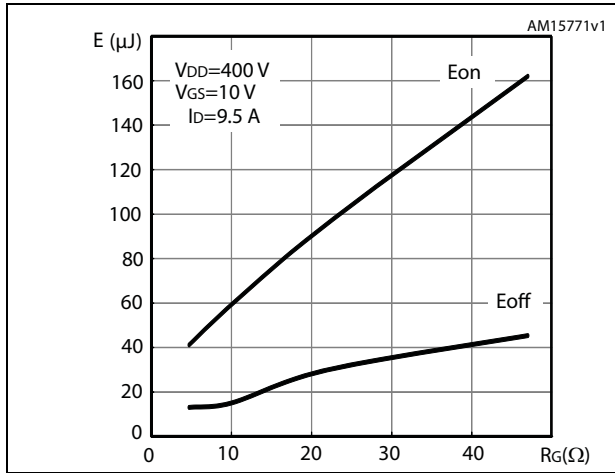

Figure 14. Switching losses vs gate resistance (1)



1. E_{on} including reverse recovery of a SiC diode

3 Test circuits

Figure 15. Switching times test circuit for resistive load



AM01468v1

Figure 16. Gate charge test circuit



AM01469v1

Figure 17. Test circuit for inductive load switching and diode recovery times



AM01470v1

Figure 18. Unclamped inductive load test circuit



AM01471v1

Figure 19. Unclamped inductive waveform



AM01472v1

Figure 20. Switching time waveform

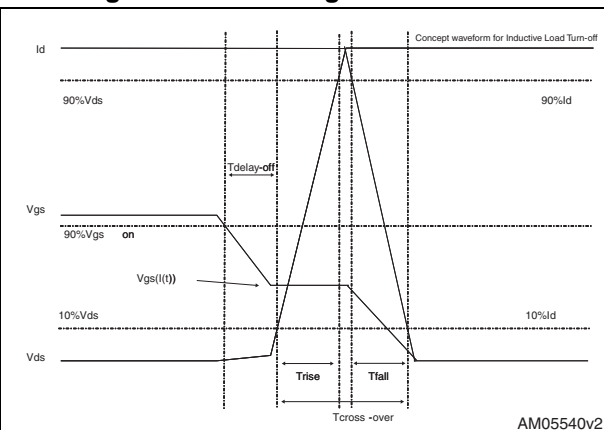

AM05540v2

4 Package mechanical data

In order to meet environmental requirements, ST offers these devices in different grades of ECOPACK[®] packages, depending on their level of environmental compliance. ECOPACK[®] specifications, grade definitions and product status are available at: www.st.com. ECOPACK[®] is an ST trademark.

Table 8. PowerFLAT™ 8x8 HV mechanical data

Dim.	mm		
	Min.	Typ.	Max.
A	0.80	0.90	1.00
A1	0.00	0.02	0.05
b	0.95	1.00	1.05
D		8.00	
E		8.00	
D2	7.05	7.20	7.30
E2	4.15	4.30	4.40
e		2.00	
L	0.40	0.50	0.60

Figure 21. PowerFLAT™ 8x8 HV drawing mechanical data

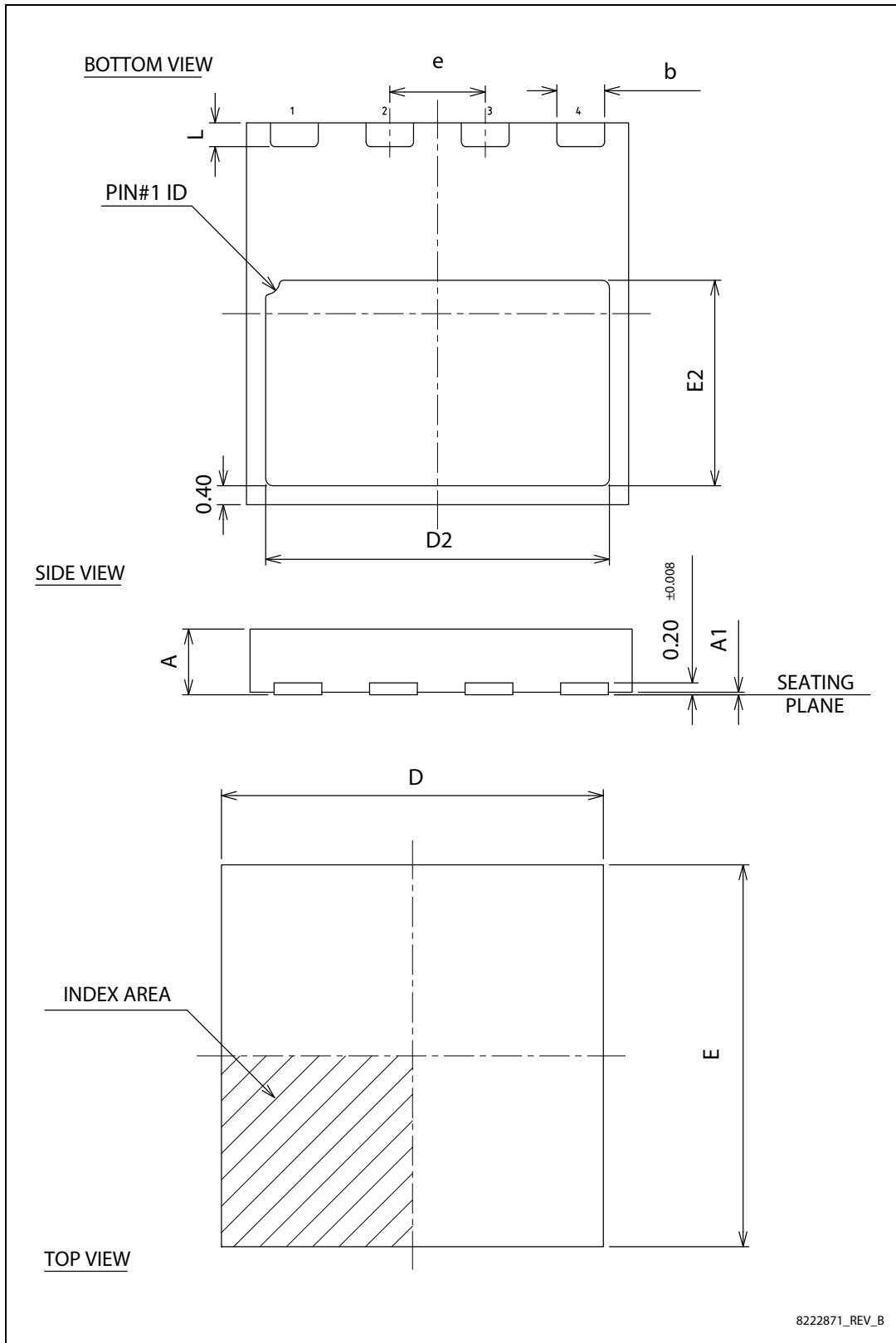

8222871_REV_B

Figure 22. PowerFLAT™ 8x8 HV recommended footprint (dimension in millimeters)

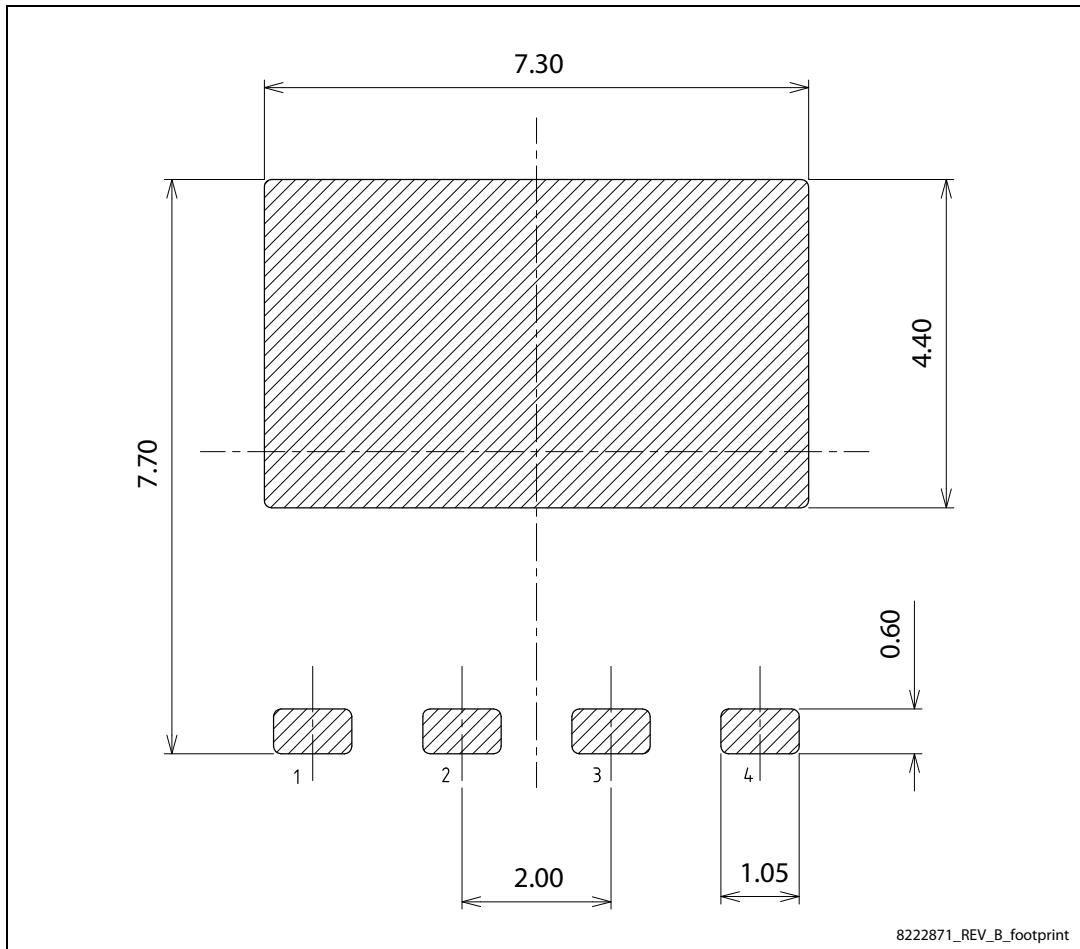

5 Packaging mechanical data

Figure 23. PowerFLAT™ 8x8 HV tape (dimension in millimeters)

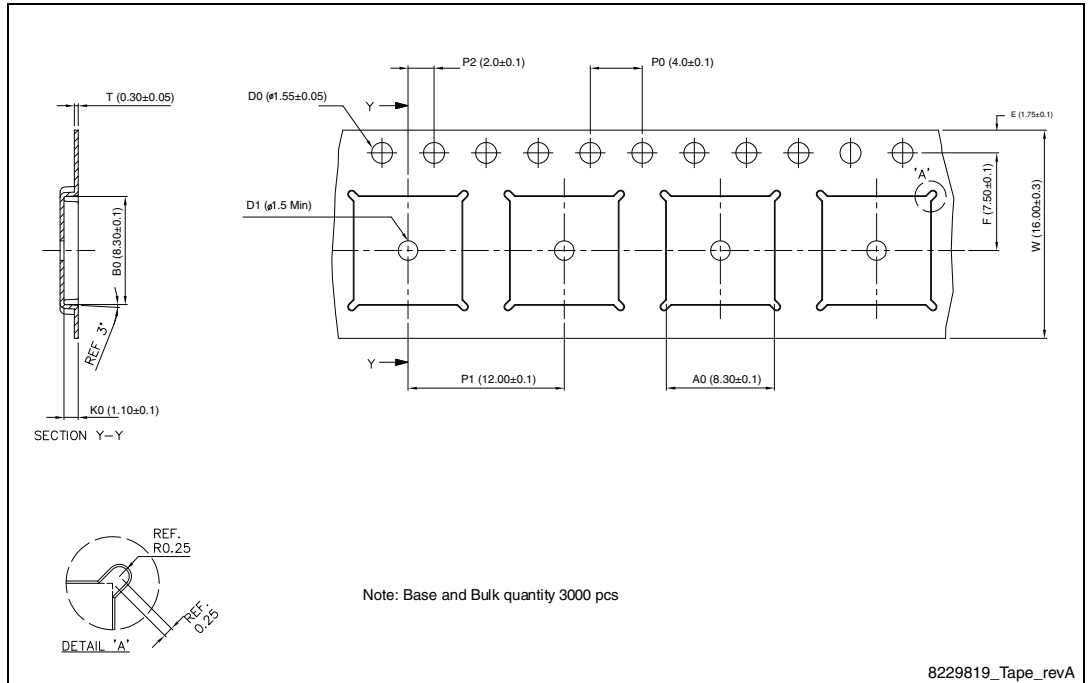

Figure 24. PowerFLAT™ 8x8 HV package orientation in carrier tape

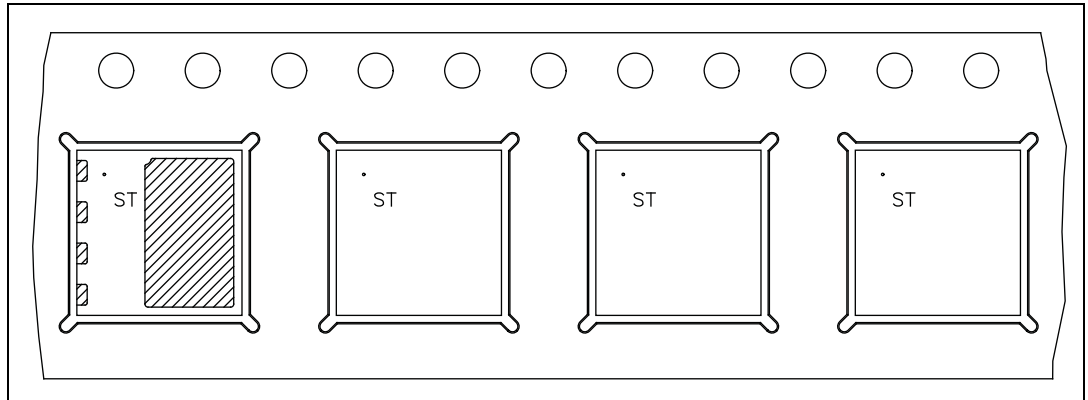
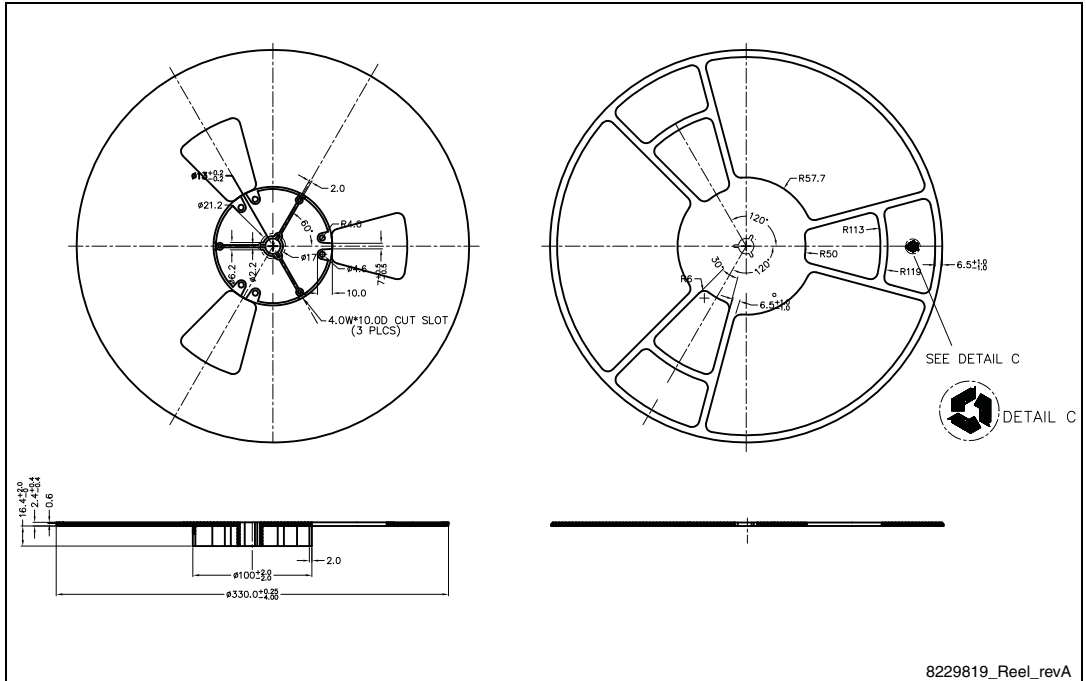

Figure 25. PowerFLAT™ 8x8 HV reel



6 Revision history

Table 9. Document revision history

Date	Revision	Changes
17-Jul-2013	1	First release

Please Read Carefully:

Information in this document is provided solely in connection with ST products. STMicroelectronics NV and its subsidiaries ("ST") reserve the right to make changes, corrections, modifications or improvements, to this document, and the products and services described herein at any time, without notice.

All ST products are sold pursuant to ST's terms and conditions of sale.

Purchasers are solely responsible for the choice, selection and use of the ST products and services described herein, and ST assumes no liability whatsoever relating to the choice, selection or use of the ST products and services described herein.

No license, express or implied, by estoppel or otherwise, to any intellectual property rights is granted under this document. If any part of this document refers to any third party products or services it shall not be deemed a license grant by ST for the use of such third party products or services, or any intellectual property contained therein or considered as a warranty covering the use in any manner whatsoever of such third party products or services or any intellectual property contained therein.

UNLESS OTHERWISE SET FORTH IN ST'S TERMS AND CONDITIONS OF SALE ST DISCLAIMS ANY EXPRESS OR IMPLIED WARRANTY WITH RESPECT TO THE USE AND/OR SALE OF ST PRODUCTS INCLUDING WITHOUT LIMITATION IMPLIED WARRANTIES OF MERCHANTABILITY, FITNESS FOR A PARTICULAR PURPOSE (AND THEIR EQUIVALENTS UNDER THE LAWS OF ANY JURISDICTION), OR INFRINGEMENT OF ANY PATENT, COPYRIGHT OR OTHER INTELLECTUAL PROPERTY RIGHT.

ST PRODUCTS ARE NOT AUTHORIZED FOR USE IN WEAPONS. NOR ARE ST PRODUCTS DESIGNED OR AUTHORIZED FOR USE IN: (A) SAFETY CRITICAL APPLICATIONS SUCH AS LIFE SUPPORTING, ACTIVE IMPLANTED DEVICES OR SYSTEMS WITH PRODUCT FUNCTIONAL SAFETY REQUIREMENTS; (B) AERONAUTIC APPLICATIONS; (C) AUTOMOTIVE APPLICATIONS OR ENVIRONMENTS, AND/OR (D) AEROSPACE APPLICATIONS OR ENVIRONMENTS. WHERE ST PRODUCTS ARE NOT DESIGNED FOR SUCH USE, THE PURCHASER SHALL USE PRODUCTS AT PURCHASER'S SOLE RISK, EVEN IF ST HAS BEEN INFORMED IN WRITING OF SUCH USAGE, UNLESS A PRODUCT IS EXPRESSLY DESIGNATED BY ST AS BEING INTENDED FOR "AUTOMOTIVE, AUTOMOTIVE SAFETY OR MEDICAL" INDUSTRY DOMAINS ACCORDING TO ST PRODUCT DESIGN SPECIFICATIONS. PRODUCTS FORMALLY ESCC, QML OR JAN QUALIFIED ARE DEEMED SUITABLE FOR USE IN AEROSPACE BY THE CORRESPONDING GOVERNMENTAL AGENCY.

Resale of ST products with provisions different from the statements and/or technical features set forth in this document shall immediately void any warranty granted by ST for the ST product or service described herein and shall not create or extend in any manner whatsoever, any liability of ST.

ST and the ST logo are trademarks or registered trademarks of ST in various countries.

Information in this document supersedes and replaces all information previously supplied.

The ST logo is a registered trademark of STMicroelectronics. All other names are the property of their respective owners.

© 2013 STMicroelectronics - All rights reserved

STMicroelectronics group of companies

Australia - Belgium - Brazil - Canada - China - Czech Republic - Finland - France - Germany - Hong Kong - India - Israel - Italy - Japan - Malaysia - Malta - Morocco - Philippines - Singapore - Spain - Sweden - Switzerland - United Kingdom - United States of America

www.st.com



X-ON Electronics

Largest Supplier of Electrical and Electronic Components

Click to view similar products for [MOSFET](#) category:

Click to view products by [STMicroelectronics](#) manufacturer:

Other Similar products are found below :

[614233C](#) [648584F](#) [IRFD120](#) [JANTX2N5237](#) [2N7000](#) [FCA20N60_F109](#) [FDZ595PZ](#) [2SK2545\(Q,T\)](#) [405094E](#) [423220D](#)
[TPCC8103,L1Q\(CM](#) [MIC4420CM-TR](#) [VN1206L](#) [614234A](#) [715780A](#) [NTNS3166NZT5G](#) [SSM6J414TU,LF\(T](#) [751625C](#)
[IPS70R2K0CEAKMA1](#) [BUK954R8-60E](#) [DMN3404LQ-7](#) [NTE6400](#) [SQJ402EP-T1-GE3](#) [2SK2614\(TE16L1,Q\)](#) [2N7002KW-FAI](#)
[DMN1017UCP3-7](#) [EFC2J004NUZTDG](#) [ECH8691-TL-W](#) [FCAB21350L1](#) [P85W28HP2F-7071](#) [DMN1053UCP4-7](#) [NTE221](#) [NTE2384](#)
[NTE2903](#) [NTE2941](#) [NTE2945](#) [NTE2946](#) [NTE2960](#) [NTE2967](#) [NTE2969](#) [NTE2976](#) [NTE455](#) [NTE6400A](#) [NTE2910](#) [NTE2916](#) [NTE2956](#)
[NTE2911](#) [TK10A80W,S4X\(S](#) [SSM6P69NU,LF](#) [DMP22D4UFO-7B](#)