

N-channel 600 V, 13 Ω typ., 0.3 A Zener-protected SuperMESH™ Power MOSFETs in SOT-223 and TO-92 packages

Datasheet - production data

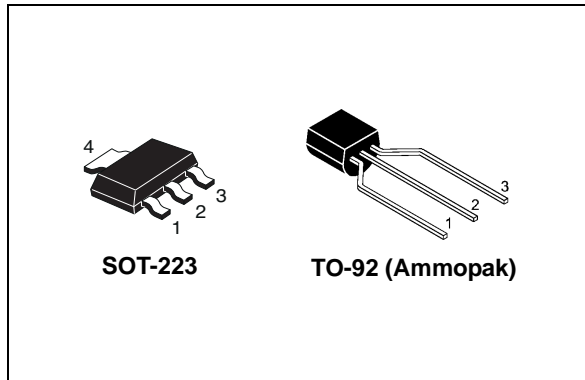

Features

Order codes	V_{DS}	$R_{DS(on)max}$	I_D	P_{TOT}
STN1NK60Z	600 V	15 Ω	0.3 A	3.3 W
STQ1NK60ZR-AP				3 W

- 100% avalanche tested
- Extremely high dv/dt capability
- Gate charge minimized
- ESD improved capability
- Zener-protected

Applications

- Switching applications

Description

These devices are N-channel Zener-protected Power MOSFETs developed using STMicroelectronics' SuperMESH™ technology, achieved through optimization of ST's well established strip-based PowerMESH™ layout. In addition to a significant reduction in on-resistance, this device is designed to ensure a high level of dv/dt capability for the most demanding applications.

Figure 1. Internal schematic diagram

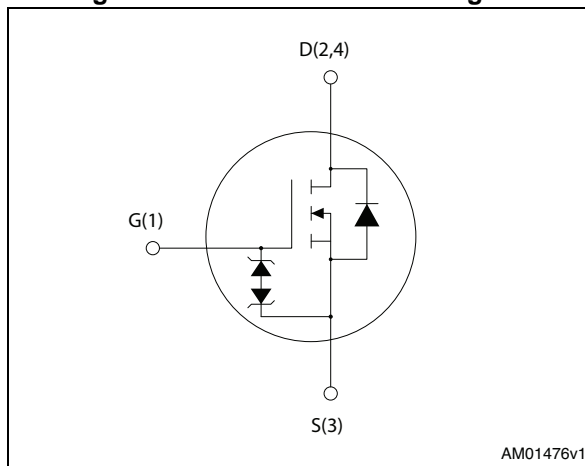

Table 1. Device summary

Order codes	Marking	Package	Packaging
STN1NK60Z	1NK60Z	SOT-223	Tape and reel
STQ1NK60ZR-AP	1NK60ZR	TO-92	Ammopak

Contents

1	Electrical ratings	3
2	Electrical characteristics	4
2.1	Electrical characteristics (curves)	6
3	Test circuits	9
4	Package mechanical data	10
4.1	SOT-223, STN1NK60Z	11
4.2	TO-92 ammopack, STQ1NK60ZR-AP	13
5	Packaging mechanical data	15
6	Revision history	17

1 Electrical ratings

Table 2. Absolute maximum ratings

Symbol	Parameter	Value		Unit
		SOT-223	TO-92	
V_{DS}	Drain-source voltage	600		V
V_{GS}	Gate-source voltage	± 30		V
I_D	Drain current (continuous) at $T_C = 25\text{ °C}$	0.3		A
I_D	Drain current (continuous) at $T_C = 100\text{ °C}$	0.189		A
$I_{DM}^{(1)}$	Drain current (pulsed)	1.2		A
P_{TOT}	Total dissipation at $T_C = 25\text{ °C}$	3.3	3	W
	Derating factor	0.026	0.024	W/°C
ESD	Human body model C=100 pF, R=1.5 kΩ	800		V
$dv/dt^{(2)}$	Peak diode recovery voltage slope	4.5		V/ns
T_J	Operating junction temperature	- 55 to 150		°C
T_{stg}	Storage temperature			°C

1. Pulse width limited by safe operating area
2. $I_{SD} \leq 0.3\text{ A}$, $di/dt \leq 200\text{ A}/\mu\text{s}$, $V_{DD} = 80\%V_{(BR)DSS}$

Table 3. Thermal resistance

Symbol	Parameter	Value		Unit
		SOT-223	TO-92	
$R_{thj-amb}$	Thermal resistance junction-ambient max	38 ⁽¹⁾	120	°C/W
$R_{thj-lead}$	Thermal resistance junction-lead max		40	°C/W

1. When mounted on 1 inch² FR-4 board, 2 Oz Cu, t < 30 s.

Table 4. Avalanche data

Symbol	Parameter	Value	Unit
I_{AR}	Avalanche current, repetitive or not repetitive (pulse width limited by T_{jmax})	0.3	A
E_{AS}	Single pulse avalanche energy (starting $T_J = 25\text{ °C}$, $I_D = I_{AR}$, $V_{DD} = 50\text{ V}$)	60	mJ

2 Electrical characteristics

($T_{CASE} = 25\text{ °C}$ unless otherwise specified)

Table 5. On/off states

Symbol	Parameter	Test conditions	Min.	Typ.	Max.	Unit
$V_{(BR)DSS}$	Drain-source breakdown voltage	$V_{GS} = 0, I_D = 1\text{ mA}$	600			V
I_{DSS}	Zero gate voltage drain current	$V_{GS} = 0, V_{DS} = 600\text{ V}$			1	μA
		$V_{GS} = 0, V_{DS} = 600\text{ V}, T_C = 125\text{ °C}$			50	μA
I_{GSS}	Gate body leakage current	$V_{DS} = 0, V_{GS} = \pm 20\text{ V}$			± 10	μA
$V_{GS(th)}$	Gate threshold voltage	$V_{DS} = V_{GS}, I_D = 50\text{ }\mu\text{A}$	3	3.75	4.5	V
$R_{DS(on)}$	Static drain-source on- resistance	$V_{GS} = 10\text{ V}, I_D = 0.4\text{ A}$		13	15	Ω

Table 6. Dynamic

Symbol	Parameter	Test conditions	Min.	Typ.	Max.	Unit
$g_{fs}^{(1)}$	Forward transconductance	$V_{DS} = 15\text{ V}, I_D = 0.4\text{ A}$	-	0.5		S
C_{ISS}	Input capacitance	$V_{GS} = 0, V_{DS} = 25\text{ V}, f = 1\text{ MHz}$	-	94		pF
C_{OSS}	Output capacitance		-	17.6		pF
C_{RSS}	Reverse transfer capacitance		-	2.8		pF
$C_{OSS\text{ eq}}^{(2)}$	Equivalent output capacitance	$V_{GS} = 0, V_{DS} = 0\text{ to }480\text{ V}$	-	11		pF
Q_g	Total gate charge	$V_{DD} = 480\text{ V}, I_D = 0.8\text{ A}$	-	4.9	6.9	nC
Q_{gs}	Gate-source charge	$V_{GS} = 10\text{ V}$	-	1		nC
Q_{gd}	Gate-drain charge	(see Figure 19)	-	2.7		nC

1. Pulsed: pulse duration=300 μs , duty cycle 1.5%
2. $C_{OSS\text{ eq}}$ is defined as a constant equivalent capacitance giving the same charging time as C_{OSS} when V_{DS} increases from 0 to 80% V_{DSS}

Table 7. Switching times

Symbol	Parameter	Test conditions	Min.	Typ.	Max.	Unit
$t_{d(on)}$	Turn-on delay time	$V_{DD} = 300\text{ V}$, $I_D = 0.4\text{ A}$, $R_G = 4.7\ \Omega$, $V_{GS} = 10\text{ V}$ (see Figure 18)	-	5.5	-	ns
t_r	Rise time		-	5	-	ns
$t_{d(off)}$	Turn-off delay time		-	13	-	ns
t_f	Fall time		-	28	-	ns

Table 8. Source drain diode

Symbol	Parameter	Test conditions	Min.	Typ.	Max.	Unit
I_{SD}	Source-drain current		-		0.8	A
$I_{SDM}^{(1)}$	Source-drain current (pulsed)		-		2.4	A
$V_{SD}^{(2)}$	Forward on voltage	$V_{GS}=0$, $I_{SD} = 0.8\text{ A}$	-		1.6	V
t_{rr}	Reverse recovery time	$I_{SD} = 0.8\text{ A}$, $di/dt = 100\text{ A}/\mu\text{s}$, $V_{DD} = 20\text{ V}$	-	135		ns
Q_{rr}	Reverse recovery charge		-	216		nC
I_{RRM}	Reverse recovery current		-	3.2		A
t_{rr}	Reverse recovery time	$I_{SD} = 0.8\text{ A}$, $di/dt = 100\text{ A}/\mu\text{s}$, $V_{DD} = 20\text{ V}$, $T_j = 150\text{ }^\circ\text{C}$	-	140		ns
Q_{rr}	Reverse recovery charge		-	224		nC
I_{RRM}	Reverse recovery current		-	3.2		A

1. Pulse width limited by safe operating area.
2. Pulsed: pulse duration=300 μs , duty cycle 1.5%

Table 9. Gate-source Zener diode

Symbol	Parameter	Test conditions	Min	Typ.	Max.	Unit
$V_{(BR)GSO}$	Gate-source breakdown voltage	$I_{GS} = \pm 1\text{ mA}$, $I_D=0$	30	-	-	V

The built-in back-to-back Zener diodes have specifically been designed to enhance the device's ESD capability. In this respect the Zener voltage is appropriate to achieve an efficient and cost-effective intervention to protect the device's integrity. These integrated Zener diodes thus avoid the usage of external components.

2.1 Electrical characteristics (curves)

Figure 2. Safe operating area for SOT-223

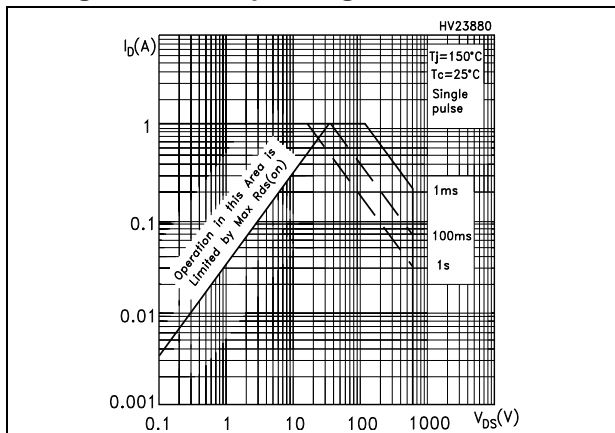

Figure 3. Thermal impedance for SOT-223

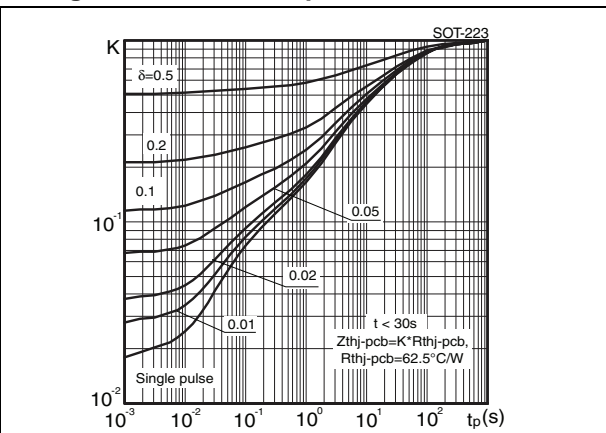

Figure 4. Safe operating area for TO-92

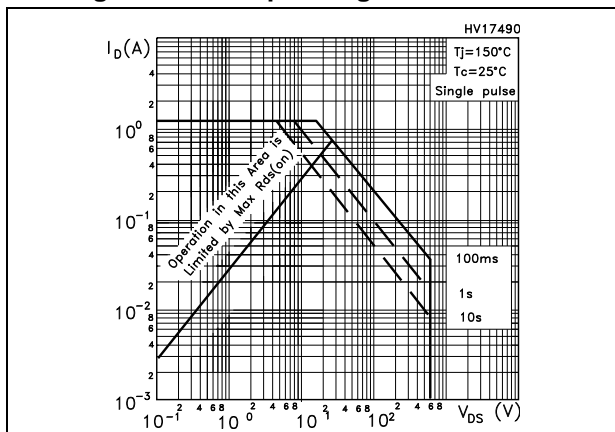

Figure 5. Thermal impedance for TO-92

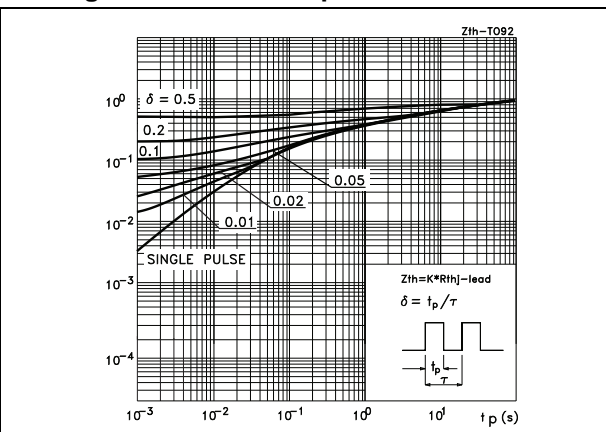

Figure 6. Output characteristics

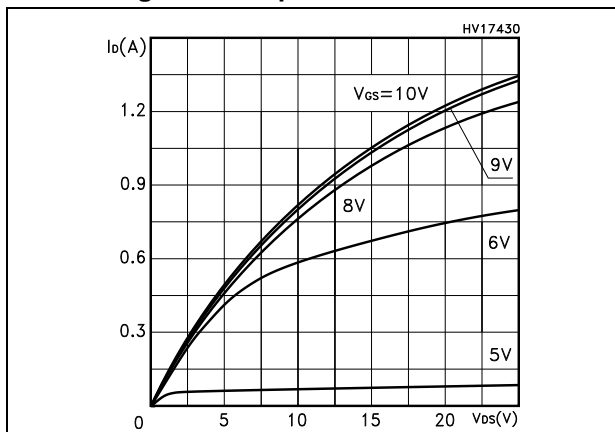

Figure 7. Transfer characteristics

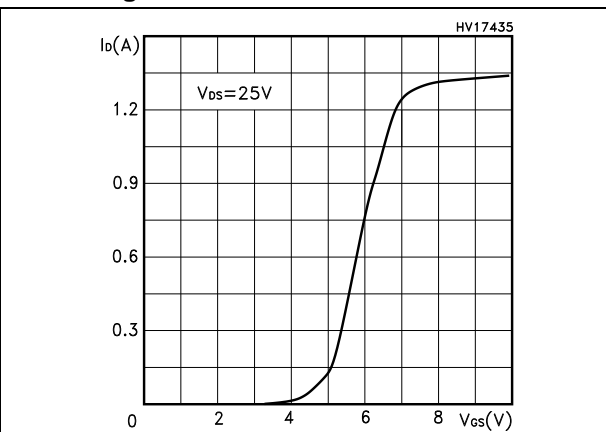

Figure 8. Transconductance

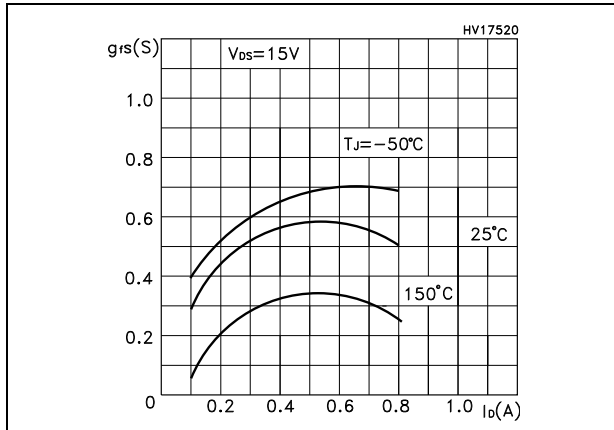

Figure 9. Static drain-source on-resistance

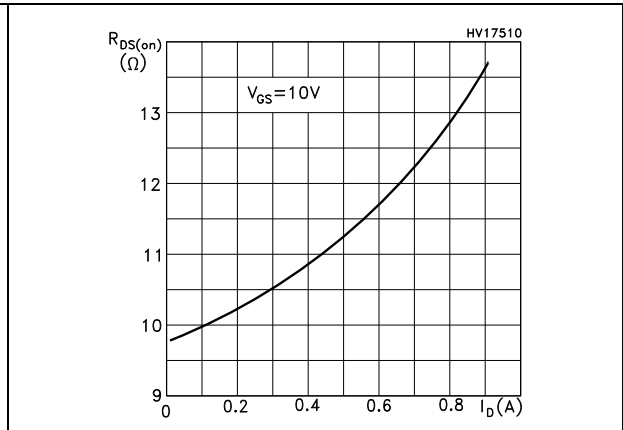

Figure 10. Gate charge vs gate-source voltage

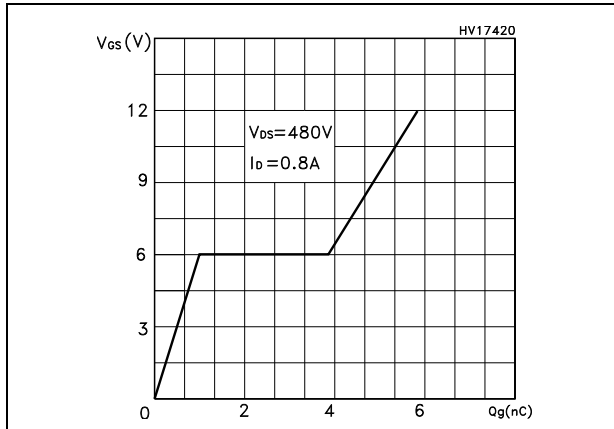

Figure 11. Capacitance variations

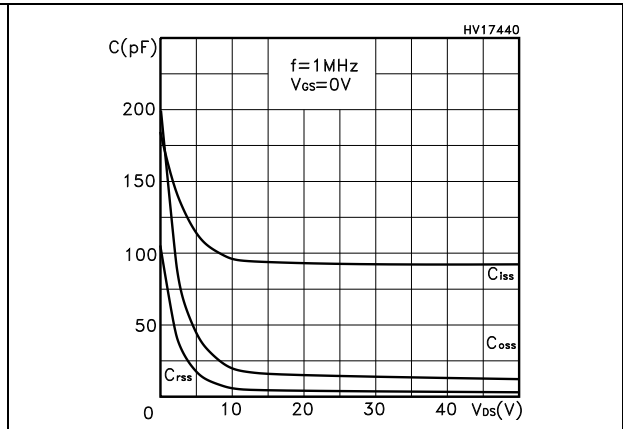

Figure 12. Normalized gate threshold voltage vs temperature

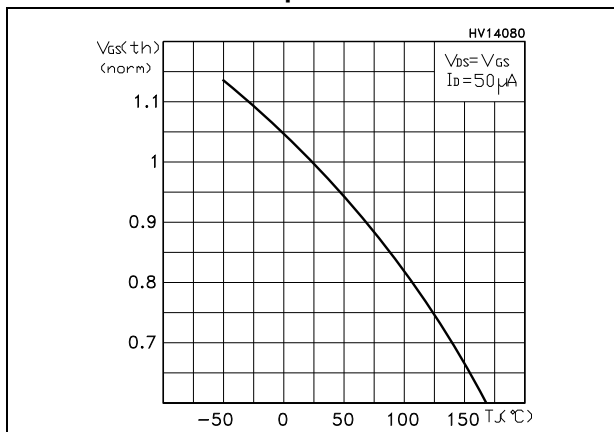

Figure 13. Normalized on-resistance vs temperature

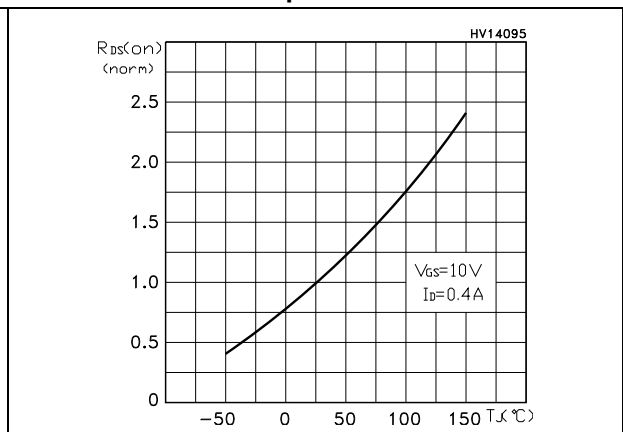

Figure 14. Source-drain diode forward characteristics

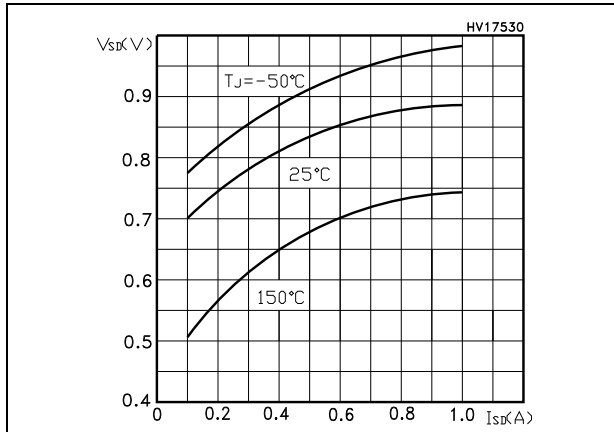

Figure 15. Normalized $V_{BR(DSS)}$ vs temperature

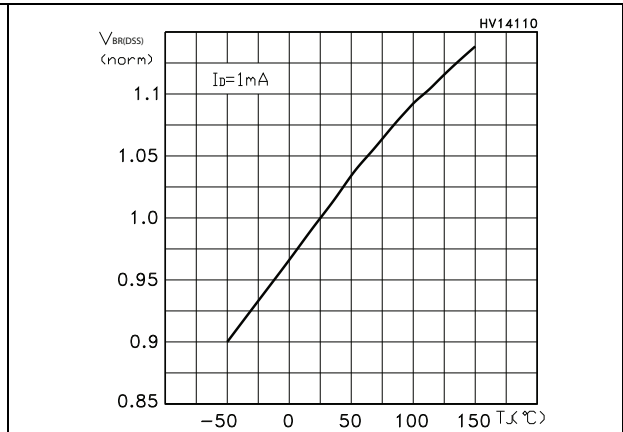

Figure 16. Maximum avalanche energy vs temperature

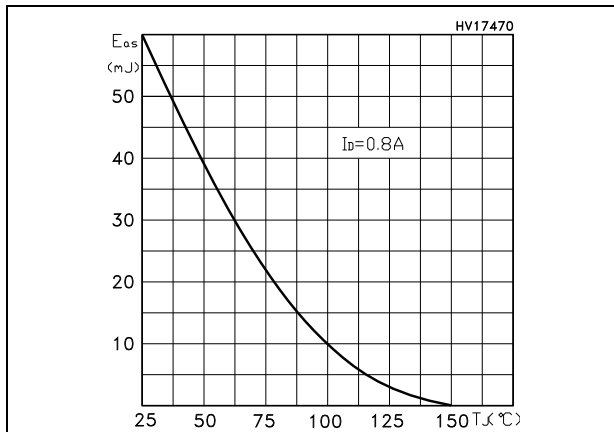
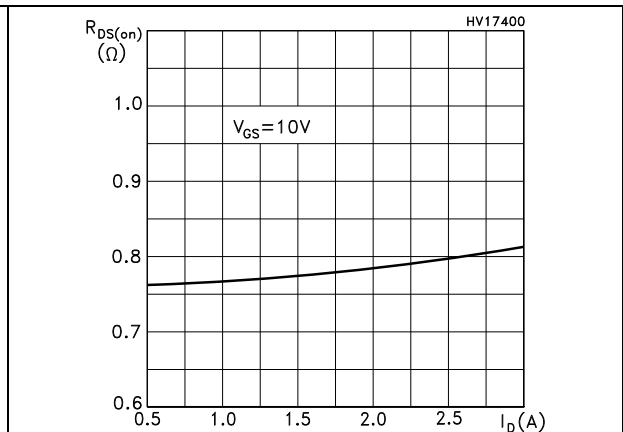

Figure 17. Max Id current vs Tc



3 Test circuits

Figure 18. Switching times test circuit for resistive load



Figure 19. Gate charge test circuit



Figure 20. Test circuit for inductive load switching and diode recovery times



Figure 21. Unclamped inductive load test circuit



Figure 22. Unclamped inductive waveform



Figure 23. Switching time waveform



4 Package mechanical data

In order to meet environmental requirements, ST offers these devices in different grades of ECOPACK[®] packages, depending on their level of environmental compliance. ECOPACK[®] specifications, grade definitions and product status are available at: www.st.com. ECOPACK[®] is an ST trademark.

Figure 24. SOT-223 mechanical data drawing

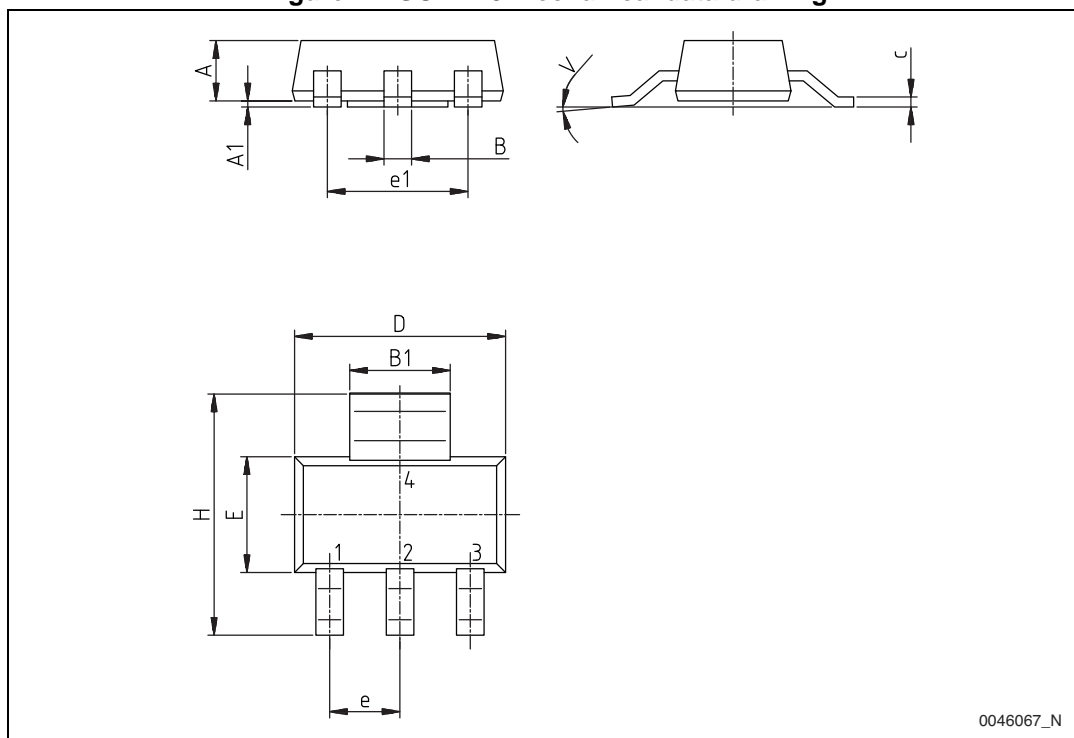

0046067_N

Table 10. SOT-223 mechanical data

Dim.	mm		
	Min.	Typ.	Max.
A			1.80
A1	0.02		0.10
B	0.60	0.70	0.85
B1	2.9	3.0	3.15
c	0.24	0.26	0.35
D	6.30	6.50	6.70
e		2.30	6.70
e1		4.60	
E	3.30	3.50	3.70
H	6.70	7.0	7.30
V			10°

Figure 25. SOT-223 footprint (dimensions in mm)

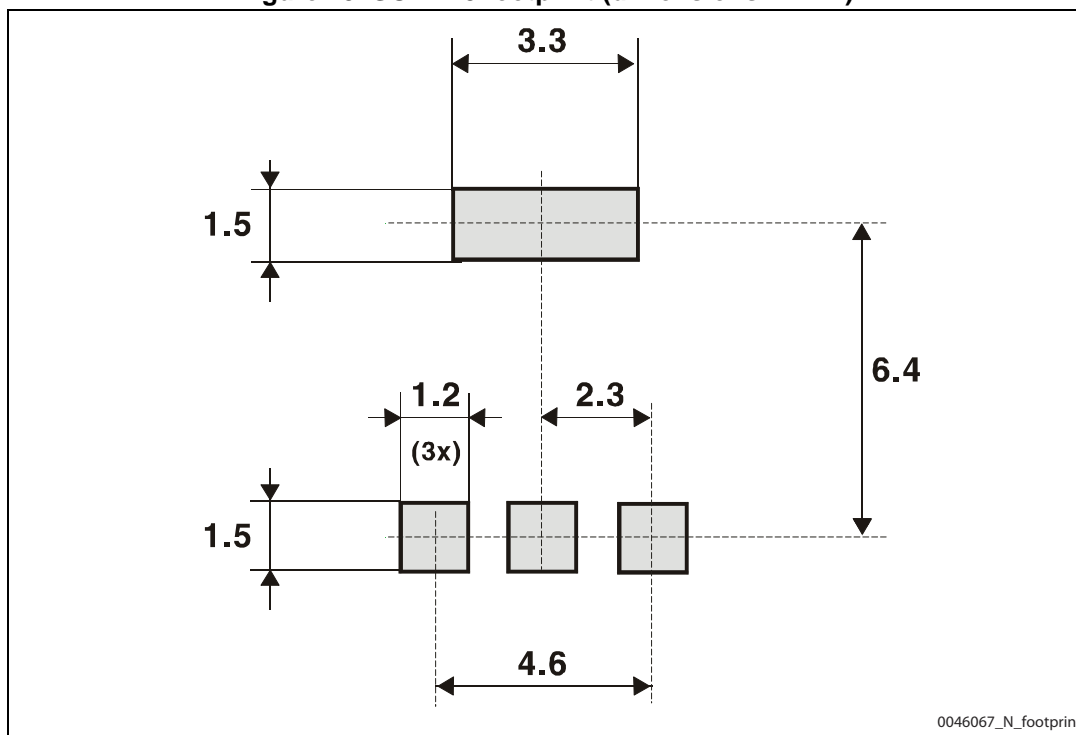

4.1 SOT-223, STN1NK60Z

4.2 TO-92 ammopack, STQ1NK60ZR-AP

Figure 26. TO-92 ammopack mechanical data drawing

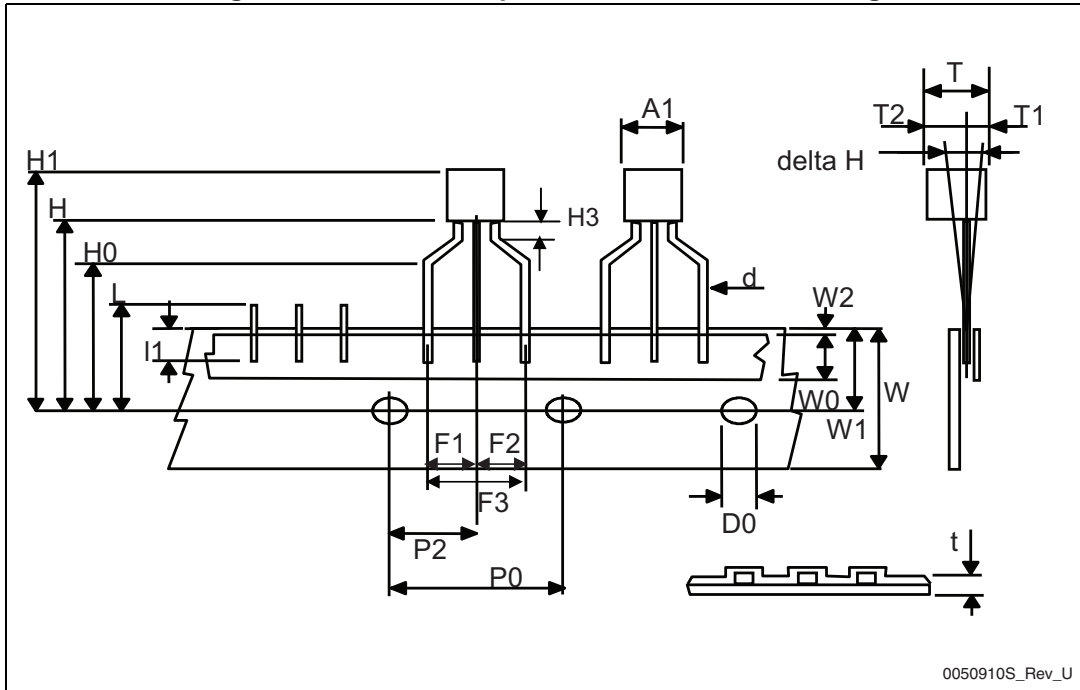

Table 11. TO-92 ammpack mechanical data

Dim.	mm		
	Min.	Typ.	Max.
A1			4.80
T			3.80
T1			1.60
T2			2.30
d	0.45	0.47	0.48
P0	12.50	12.70	12.90
P2	5.65	6.35	7.05
F1, F2	2.40	2.50	2.94
F3	4.98	5.08	5.48
delta H	-2.00		2.00
W	17.50	18.00	19.00
W0	5.5	6.00	6.5
W1	8.50	9.00	9.25
W2			0.50
H		18.50	21
H3	0.5	1	2
H0	15.50	16.00	18.8
H1		25.0	27.0
D0	3.80	4.00	4.20
t			0.90
L			11.00
l1	3.00		
delta P	-1.00		1.00

5 Packaging mechanical data

Figure 27. Tape for SOT-223 (dimensions are in mm)

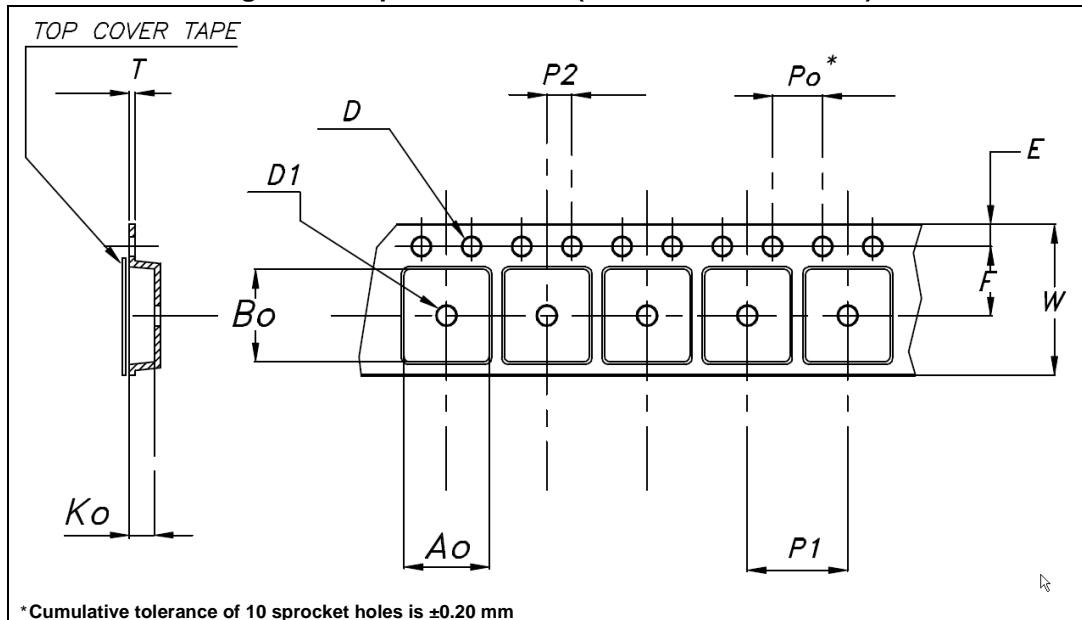

Figure 28. Reel for TO-223 (dimensions are in mm)

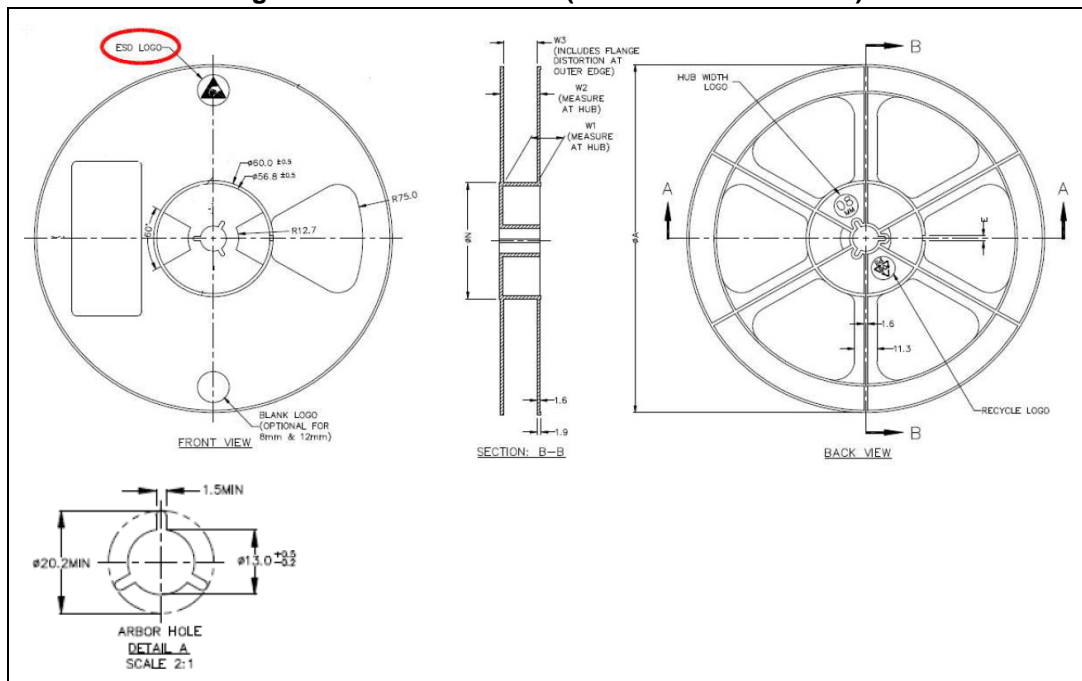

Table 12. SOT-223 tape and reel mechanical data

Tape				Reel		
Dim.	mm			Dim.	mm	
	Min.	Typ.	Max.		Min.	Max.
A0	6.75	6.85	6.95	A		180
B0	7.30	7.40	7.50	N	60	
K0	1.80	1.90	2.00	W1		12.4
F	5.40	5.50	5.60	W2		18.4
E	1.65	1.75	1.85	W3	11.9	15.4
W	11.7	12	12.3			
P2	1.90	2	2.10	Base quantity pcs		1000
P0	3.90	4	4.10	Bulk quantity pcs		1000
P1	7.90	8	8.10			
T	0.25	0.30	0.35			
D ϕ	1.50	1.55	1.60			
D1 ϕ	1.50	1.60	1.70			

6 Revision history

Table 13. Revision history

Date	Revision	Changes
19-Mar-2003	3	First electronic version
15-May-2003	4	Removed DPAK
09-Jun-2003	5	Final datasheet
17-Nov-2004	6	Inserted SOT-223
15-Feb-2005	7	Modified Figure 4 .
07-Sep-2005	8	Inserted ecopack indication
22-Feb-2006	9	The document has been reformatted
01-Jun-2007	10	Order code table on first page has been updated
19-Jul-2007	11	Table 1: Device summary has been updated
05-Jan-2011	12	Corrected Figure 2: Safe operating area for SOT-223 and Figure 3: Thermal impedance for SOT-223
05-Jun-2014	13	<ul style="list-style-type: none"> – Updated title. – Updated derating factor in Table 2: Absolute maximum ratings. – Updated Section 4: Package mechanical data. – Minor text changes.
04-Jul-2014	14	– Updated Section 3: Test circuits .

Please Read Carefully:

Information in this document is provided solely in connection with ST products. STMicroelectronics NV and its subsidiaries ("ST") reserve the right to make changes, corrections, modifications or improvements, to this document, and the products and services described herein at any time, without notice.

All ST products are sold pursuant to ST's terms and conditions of sale.

Purchasers are solely responsible for the choice, selection and use of the ST products and services described herein, and ST assumes no liability whatsoever relating to the choice, selection or use of the ST products and services described herein.

No license, express or implied, by estoppel or otherwise, to any intellectual property rights is granted under this document. If any part of this document refers to any third party products or services it shall not be deemed a license grant by ST for the use of such third party products or services, or any intellectual property contained therein or considered as a warranty covering the use in any manner whatsoever of such third party products or services or any intellectual property contained therein.

UNLESS OTHERWISE SET FORTH IN ST'S TERMS AND CONDITIONS OF SALE ST DISCLAIMS ANY EXPRESS OR IMPLIED WARRANTY WITH RESPECT TO THE USE AND/OR SALE OF ST PRODUCTS INCLUDING WITHOUT LIMITATION IMPLIED WARRANTIES OF MERCHANTABILITY, FITNESS FOR A PARTICULAR PURPOSE (AND THEIR EQUIVALENTS UNDER THE LAWS OF ANY JURISDICTION), OR INFRINGEMENT OF ANY PATENT, COPYRIGHT OR OTHER INTELLECTUAL PROPERTY RIGHT.

ST PRODUCTS ARE NOT DESIGNED OR AUTHORIZED FOR USE IN: (A) SAFETY CRITICAL APPLICATIONS SUCH AS LIFE SUPPORTING, ACTIVE IMPLANTED DEVICES OR SYSTEMS WITH PRODUCT FUNCTIONAL SAFETY REQUIREMENTS; (B) AERONAUTIC APPLICATIONS; (C) AUTOMOTIVE APPLICATIONS OR ENVIRONMENTS, AND/OR (D) AEROSPACE APPLICATIONS OR ENVIRONMENTS. WHERE ST PRODUCTS ARE NOT DESIGNED FOR SUCH USE, THE PURCHASER SHALL USE PRODUCTS AT PURCHASER'S SOLE RISK, EVEN IF ST HAS BEEN INFORMED IN WRITING OF SUCH USAGE, UNLESS A PRODUCT IS EXPRESSLY DESIGNATED BY ST AS BEING INTENDED FOR "AUTOMOTIVE, AUTOMOTIVE SAFETY OR MEDICAL" INDUSTRY DOMAINS ACCORDING TO ST PRODUCT DESIGN SPECIFICATIONS. PRODUCTS FORMALLY ESCC, QML OR JAN QUALIFIED ARE DEEMED SUITABLE FOR USE IN AEROSPACE BY THE CORRESPONDING GOVERNMENTAL AGENCY.

Resale of ST products with provisions different from the statements and/or technical features set forth in this document shall immediately void any warranty granted by ST for the ST product or service described herein and shall not create or extend in any manner whatsoever, any liability of ST.

ST and the ST logo are trademarks or registered trademarks of ST in various countries.

Information in this document supersedes and replaces all information previously supplied.

The ST logo is a registered trademark of STMicroelectronics. All other names are the property of their respective owners.

© 2014 STMicroelectronics - All rights reserved

STMicroelectronics group of companies

Australia - Belgium - Brazil - Canada - China - Czech Republic - Finland - France - Germany - Hong Kong - India - Israel - Italy - Japan - Malaysia - Malta - Morocco - Philippines - Singapore - Spain - Sweden - Switzerland - United Kingdom - United States of America

www.st.com

X-ON Electronics

Largest Supplier of Electrical and Electronic Components

Click to view similar products for [MOSFET](#) category:

Click to view products by [STMicroelectronics](#) manufacturer:

Other Similar products are found below :

[614233C](#) [648584F](#) [IRFD120](#) [JANTX2N5237](#) [FCA20N60_F109](#) [FDZ595PZ](#) [2SK2545\(Q,T\)](#) [405094E](#) [423220D](#) [TPCC8103,L1Q\(CM](#)
[MIC4420CM-TR](#) [VN1206L](#) [SBVS138LT1G](#) [614234A](#) [715780A](#) [NTNS3166NZT5G](#) [SSM6J414TU,LF\(T](#) [751625C](#) [BUK954R8-60E](#)
[DMN3404LQ-7](#) [NTE6400](#) [SQJ402EP-T1-GE3](#) [2SK2614\(TE16L1,Q\)](#) [2N7002KW-FAI](#) [DMN1017UCP3-7](#) [EFC2J004NUZTDG](#) [ECH8691-](#)
[TL-W](#) [FCAB21350L1](#) [P85W28HP2F-7071](#) [DMN1053UCP4-7](#) [NTE221](#) [NTE2384](#) [NTE2903](#) [NTE2941](#) [NTE2945](#) [NTE2946](#) [NTE2960](#)
[NTE2967](#) [NTE2969](#) [NTE2976](#) [NTE455](#) [NTE6400A](#) [NTE2910](#) [NTE2916](#) [NTE2956](#) [NTE2911](#) [DMN2080UCB4-7](#) [TK10A80W,S4X\(S](#)
[SSM6P69NU,LF](#) [DMP22D4UFO-7B](#)