



STB30NF10 STP30NF10 - STP30NF10FP

N-channel 100V - 0.038Ω - 35A - D²PAK/TO-220/TO-220FP
Low gate charge STripFET™ II Power MOSFET

General features

Type	V _{DSS}	R _{DS(on)}	I _D
STB30NF10	100V	<0.045Ω	35A
STP30NF10	100V	<0.045Ω	35A
STP30NF10FP	100V	<0.045Ω	35A

- Exceptional dv/dt capability
- 100% avalanche tested
- Application oriented characterization

Description

This Power MOSFET is the latest development of STMicroelectronics unique "Single Feature Size™" strip-based process. The resulting transistor shows extremely high packing density for low on-resistance, rugged avalanche characteristics and less critical alignment steps therefore a remarkable manufacturing reproducibility.

Applications

- Switching application

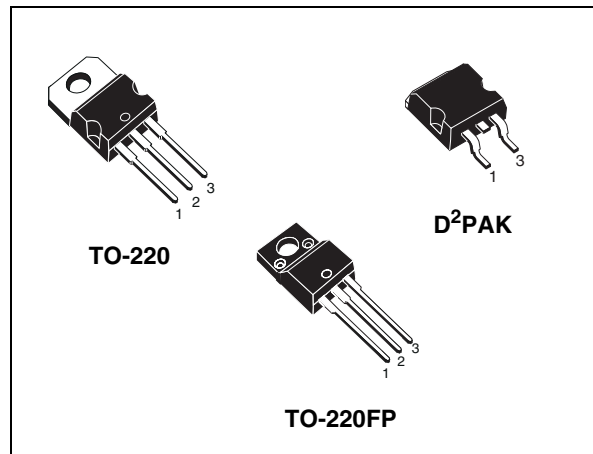

Internal schematic diagram

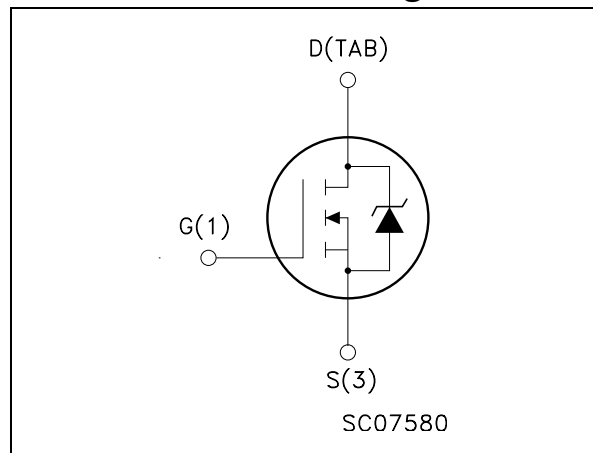

Order codes

Sales type	Marking	Package	Packaging
STB30NF10T4	B30NF10	D ² PAK	Tape & reel
STP30NF10	P30NF10	TO-220	Tube
STP30NF10FP	P30NF10FP	TO-220FP	Tube

Contents

1	Electrical ratings	3
2	Electrical characteristics	4
	2.1 Electrical characteristics (curves)	6
3	Test circuit	9
4	Package mechanical data	10
5	Packaging mechanical data	14
6	Revision history	15

1 Electrical ratings

Table 1. Absolute maximum ratings

Symbol	Parameter	Value		Unit
		D ² PAK TO-220	TO-220FP	
V _{DS}	Drain-source voltage (V _{GS} = 0)	100		V
V _{DGR}	Drain-gate voltage (R _{GS} = 20 kΩ)	100		V
V _{GS}	Gate- source voltage	± 20		V
I _D	Drain current (continuous) at T _C = 25°C	35	18	A
I _D	Drain current (continuous) at T _C = 100°C	25	13	A
I _{DM} ⁽¹⁾	Drain current (pulsed)	140	72	A
P _{tot}	Total dissipation at T _C = 25°C	115	30	W
	Derating Factor	0.77	0.2	W/°C
dv/dt ⁽²⁾	Peak diode recovery voltage slope	28		V/ns
E _{AS} ⁽³⁾	Single pulse avalanche energy	275		mJ
V _{ISO}	Insulation withstand voltage (DC)	--	2500	V
T _{stg}	Storage temperature	-55 to 175		°C
T _j	Max. operating junction temperature			

1. Pulse width limited by safe operating area.
2. I_{SD} ≤ 30A, di/dt ≤ 400A/μs, V_{DD} ≤ V_{(BR)DSS}, T_j ≤ T_{JMAX}
3. Starting T_j = 25 °C, I_D = 15A, V_{DD} = 30V

Table 2. Thermal data

	Parameter	D ² PAK TO-220	TO-220FP	Unit
		R _{thj-case}	Thermal resistance junction-case max	
R _{thj-amb}	Thermal resistance junction-ambient max	62.5		°C/W
T _J	Maximum lead temperature for soldering purpose	300		°C

2 Electrical characteristics

($T_{CASE}=25^{\circ}C$ unless otherwise specified)

Table 3. On/off states

Symbol	Parameter	Test conditions	Min.	Typ.	Max.	Unit
$V_{(BR)DSS}$	Drain-source breakdown voltage	$I_D = 250\mu A, V_{GS} = 0$	100			V
I_{DSS}	Zero gate voltage drain current ($V_{GS} = 0$)	$V_{DS} = \text{max ratings}$ $V_{DS} = \text{max ratings},$ $T_C = 125^{\circ}C$			1 10	μA μA
I_{GSS}	Gate-body leakage current ($V_{DS} = 0$)	$V_{GS} = \pm 20V$			± 100	nA
$V_{GS(th)}$	Gate threshold voltage	$V_{DS} = V_{GS}, I_D = 250\mu A$	2	3	4	V
$R_{DS(on)}$	Static drain-source on resistance	$V_{GS} = 10V, I_D = 15A$		0.038	0.045	Ω

Table 4. Dynamic

Symbol	Parameter	Test conditions	Min.	Typ.	Max.	Unit
$g_{fs}^{(1)}$	Forward transconductance	$V_{DS} = 15V, I_D = 15A$		10		S
C_{iss} C_{oss} C_{rss}	Input capacitance Output capacitance Reverse transfer capacitance	$V_{DS} = 25V, f = 1MHz,$ $V_{GS} = 0$		1180 180 80		pF pF pF
$t_{d(on)}$ t_r $t_{d(off)}$ t_f	Turn-on delay time Rise time Turn-off delay time Fall time	$V_{DD} = 50V, I_D = 15A$ $R_G = 4.7\Omega, V_{GS} = 10V$ (see Figure 15)		15 40 45 10		ns ns ns ns
Q_g Q_{gs} Q_{gd}	Total gate charge Gate-source charge Gate-drain charge	$V_{DD} = 80V, I_D = 12A,$ $V_{GS} = 10V$ (see Figure 16)		40 8 15	55	nC nC nC

1. Pulsed: Pulse duration = 300 μs , duty cycle 1.5 %.

Table 5. Source drain diode

Symbol	Parameter	Test conditions	Min.	Typ.	Max.	Unit
I_{SD} $I_{SDM}^{(1)}$	Source-drain current Source-drain current (pulsed)				35 140	A A
$V_{SD}^{(2)}$	Forward on voltage	$I_{SD} = 30A, V_{GS} = 0$			1.3	V
t_{rr} Q_{rr} I_{RRM}	Reverse recovery time Reverse recovery charge Reverse recovery current	$I_{SD} = 30A,$ $di/dt = 100A/\mu s,$ $V_{DD} = 55V, T_j = 150^\circ C$ (see Figure 17)		110 390 7.5		ns nC A

1. Pulse width limited by safe operating area.
2. Pulsed: Pulse duration = 300 μs , duty cycle 1.5 %

2.1 Electrical characteristics (curves)

Figure 1. Safe operating area for TO-220/D²PAK

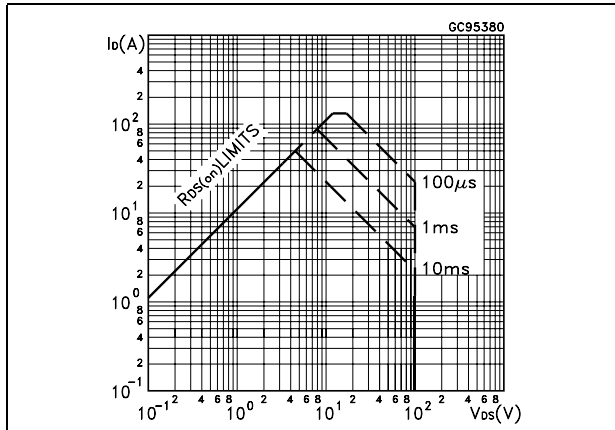

Figure 2. Thermal impedance for TO-220/D²PAK

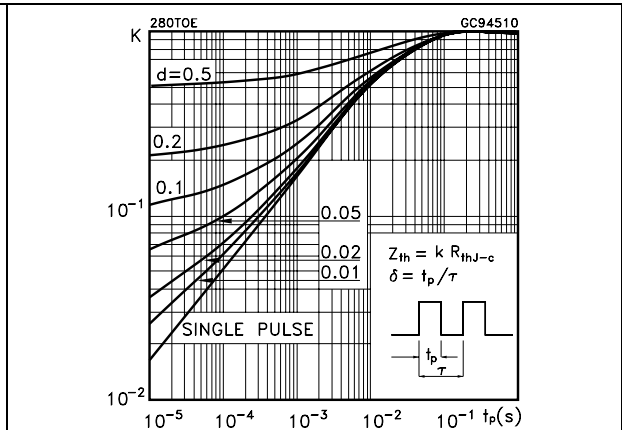

Figure 3. Safe operating area for TO-220FP

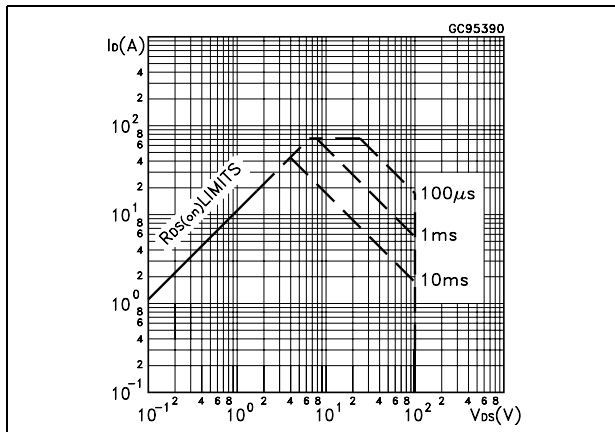

Figure 4. Thermal impedance for TO-220FP

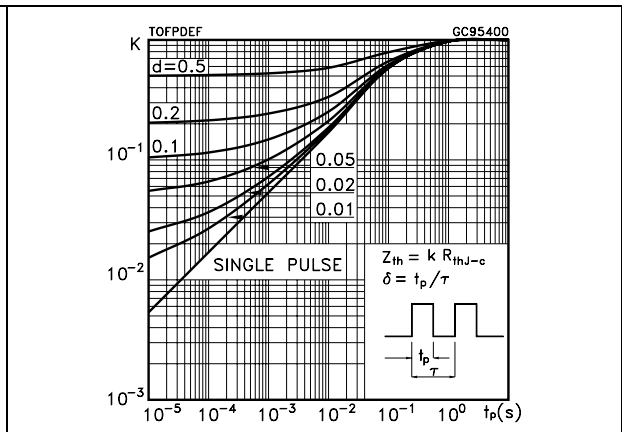

Figure 5. Output characteristics

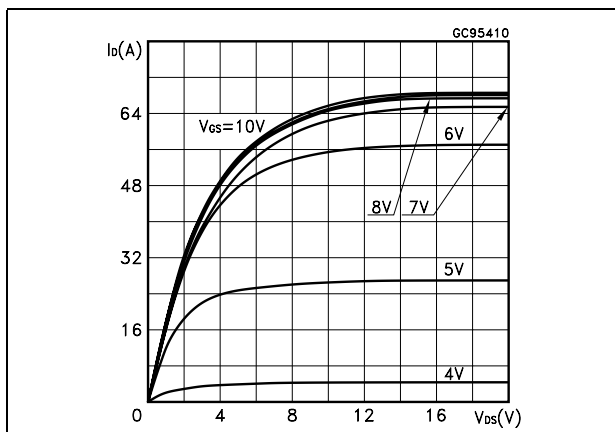

Figure 6. Transfer characteristics

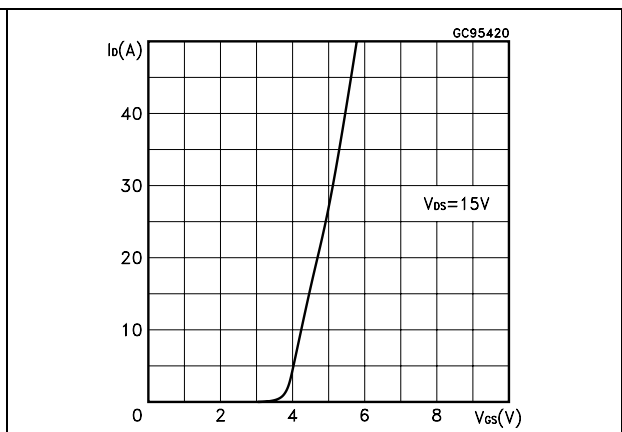

Figure 7. Transconductance

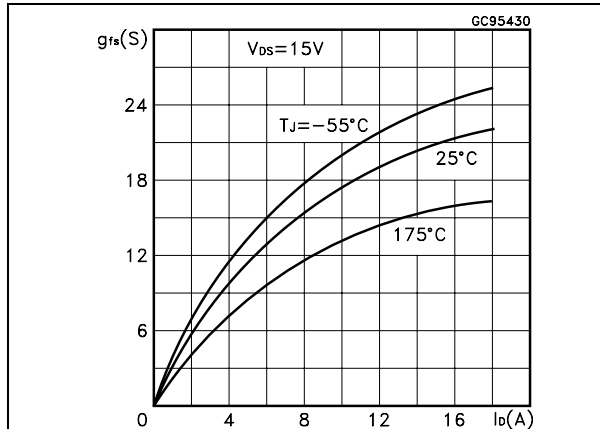

Figure 8. Static drain-source on resistance

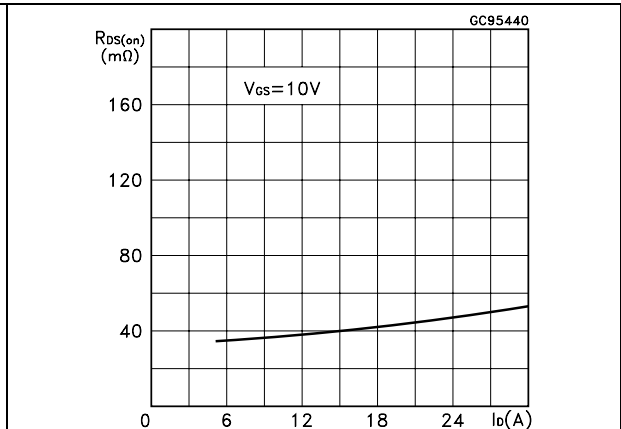

Figure 9. Gate charge vs gate-source voltage

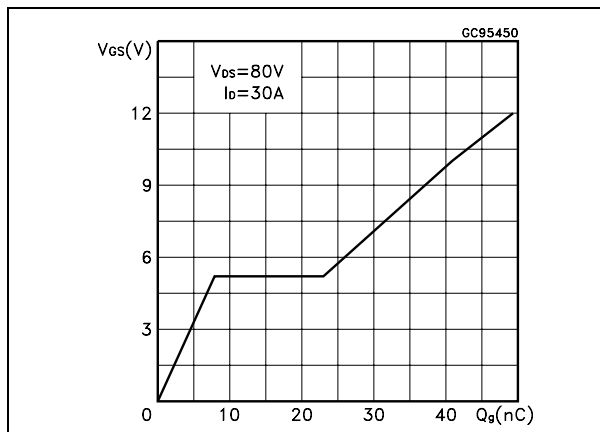

Figure 10. Capacitance variations

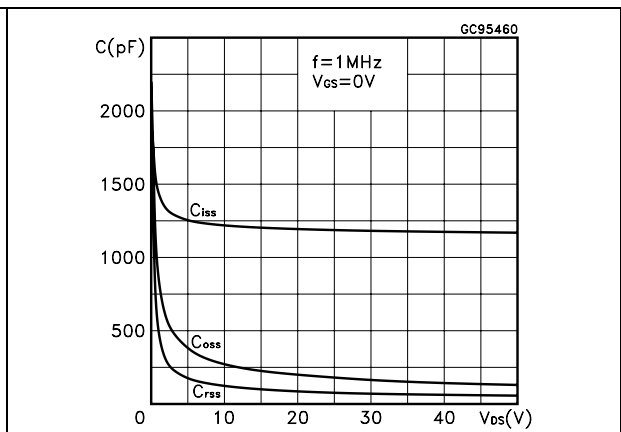

Figure 11. Normalized gate threshold voltage vs temperature

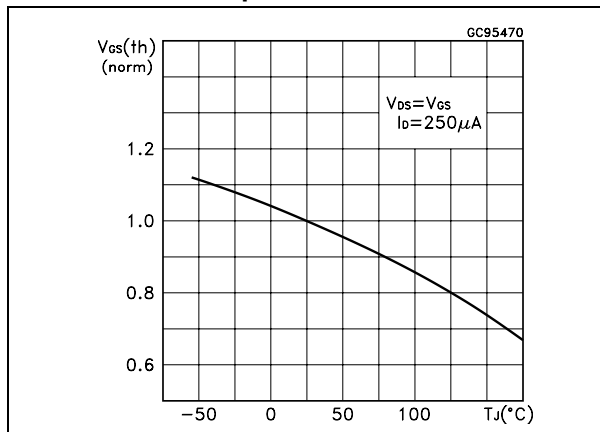

Figure 12. Normalized on resistance vs temperature

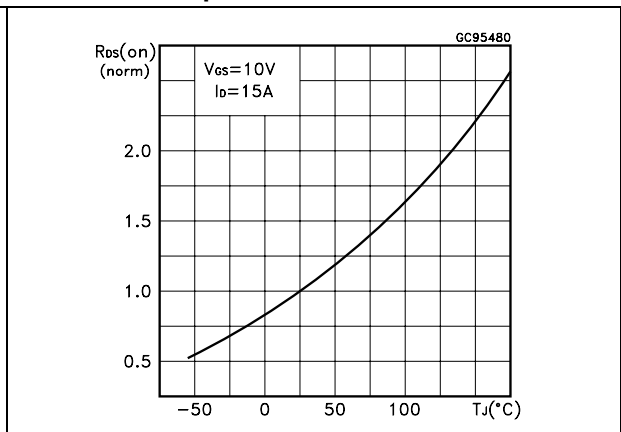

Figure 13. Source-drain diode forward characteristics

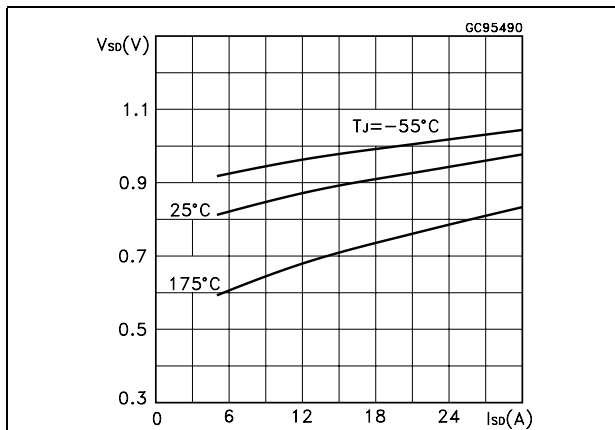
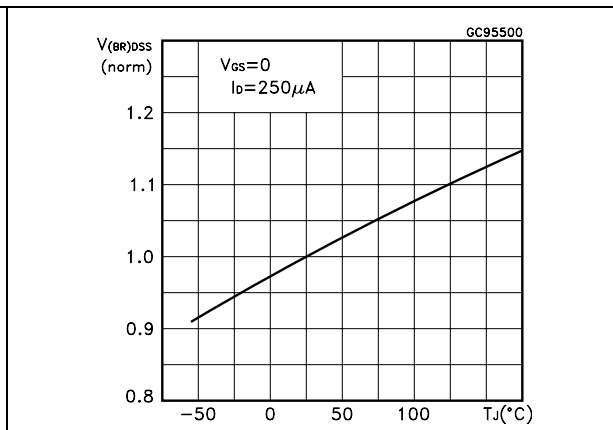

Figure 14. Normalized B_{VDSS} vs temperature



3 Test circuit

Figure 15. Switching times test circuit for resistive load



Figure 16. Gate charge test circuit



Figure 17. Test circuit for inductive load switching and diode recovery times



Figure 18. Unclamped Inductive load test circuit



Figure 19. Unclamped inductive waveform



Figure 20. Switching time waveform



4 Package mechanical data

In order to meet environmental requirements, ST offers these devices in ECOPACK® packages. These packages have a Lead-free second level interconnect . The category of second level interconnect is marked on the package and on the inner box label, in compliance with JEDEC Standard JESD97. The maximum ratings related to soldering conditions are also marked on the inner box label. ECOPACK is an ST trademark. ECOPACK specifications are available at: www.st.com

D²PAK MECHANICAL DATA

DIM.	mm.			inch		
	MIN.	TYP.	MAX.	MIN.	TYP.	MAX.
A	4.4		4.6	0.173		0.181
A1	2.49		2.69	0.098		0.106
A2	0.03		0.23	0.001		0.009
B	0.7		0.93	0.027		0.036
B2	1.14		1.7	0.044		0.067
C	0.45		0.6	0.017		0.023
C2	1.23		1.36	0.048		0.053
D	8.95		9.35	0.352		0.368
D1		8			0.315	
E	10		10.4	0.393		
E1		8.5			0.334	
G	4.88		5.28	0.192		0.208
L	15		15.85	0.590		0.625
L2	1.27		1.4	0.050		0.055
L3	1.4		1.75	0.055		0.068
M	2.4		3.2	0.094		0.126
R		0.4			0.015	
V2	0°		4°			

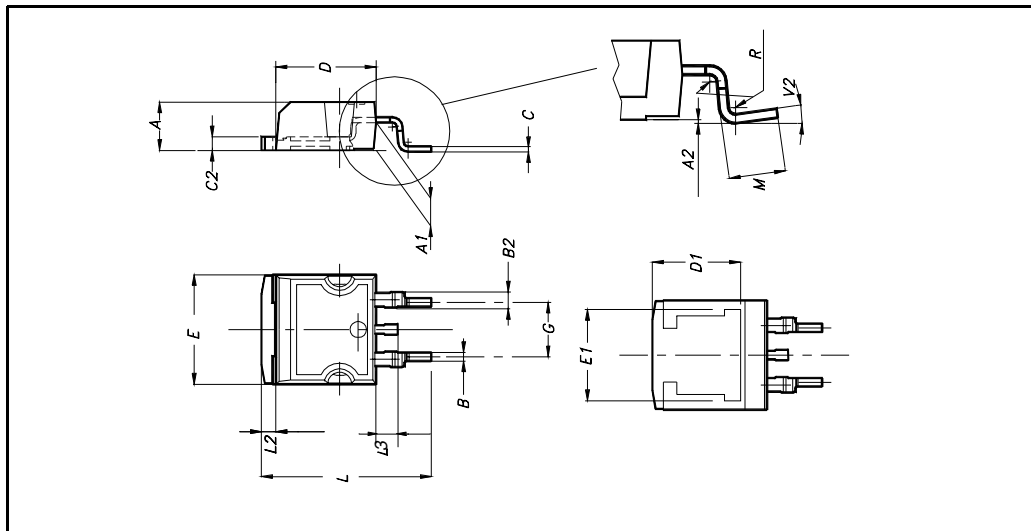

TO-220FP MECHANICAL DATA

DIM.	mm.			inch		
	MIN.	TYP.	MAX.	MIN.	TYP.	MAX.
A	4.4		4.6	0.173		0.181
B	2.5		2.7	0.098		0.106
D	2.5		2.75	0.098		0.108
E	0.45		0.7	0.017		0.027
F	0.75		1	0.030		0.039
F1	1.15		1.7	0.045		0.067
F2	1.15		1.7	0.045		0.067
G	4.95		5.2	0.195		0.204
G1	2.4		2.7	0.094		0.106
H	10		10.4	0.393		0.409
L2		16			0.630	
L3	28.6		30.6	1.126		1.204
L4	9.8		10.6	.0385		0.417
L5	2.9		3.6	0.114		0.141
L6	15.9		16.4	0.626		0.645
L7	9		9.3	0.354		0.366
Ø	3		3.2	0.118		0.126

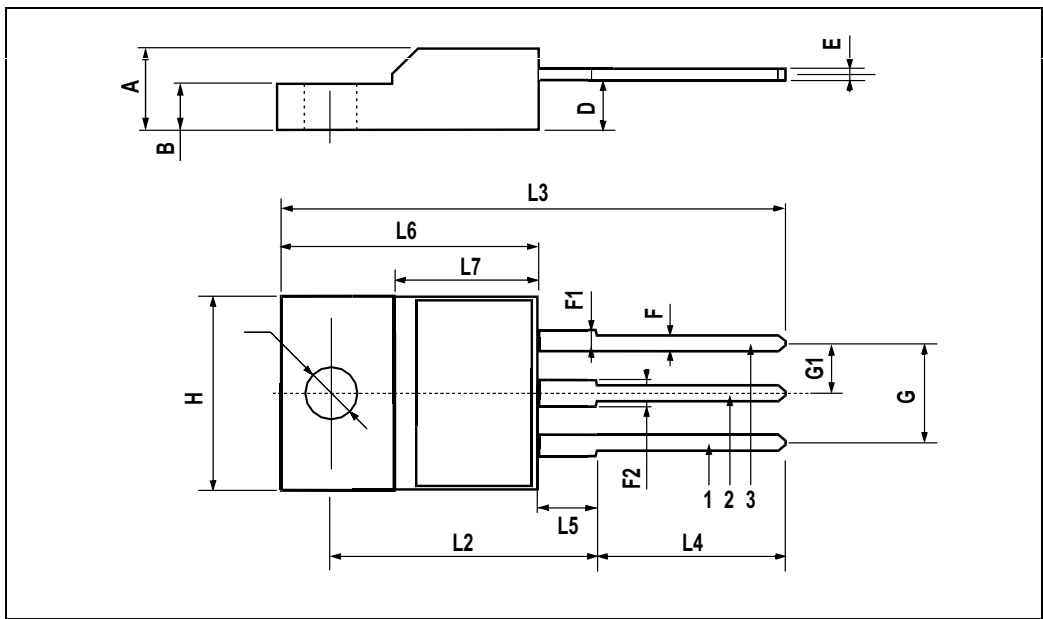

TO-220 MECHANICAL DATA

DIM.	mm.			inch		
	MIN.	TYP.	MAX.	MIN.	TYP.	MAX.
A	4.40		4.60	0.173		0.181
b	0.61		0.88	0.024		0.034
b1	1.15		1.70	0.045		0.066
c	0.49		0.70	0.019		0.027
D	15.25		15.75	0.60		0.620
E	10		10.40	0.393		0.409
e	2.40		2.70	0.094		0.106
e1	4.95		5.15	0.194		0.202
F	1.23		1.32	0.048		0.052
H1	6.20		6.60	0.244		0.256
J1	2.40		2.72	0.094		0.107
L	13		14	0.511		0.551
L1	3.50		3.93	0.137		0.154
L20		16.40			0.645	
L30		28.90			1.137	
øP	3.75		3.85	0.147		0.151
Q	2.65		2.95	0.104		0.116

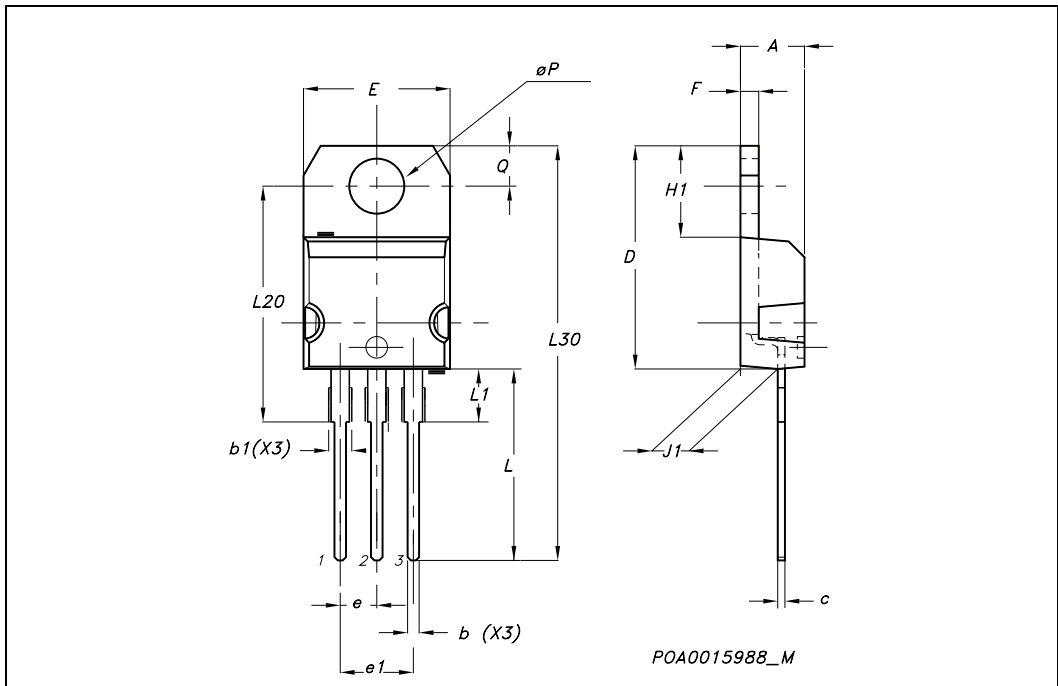

5 Packaging mechanical data

D²PAK FOOTPRINT



TAPE AND REEL SHIPMENT

TAPE MECHANICAL DATA

DIM.	mm		inch	
	MIN.	MAX.	MIN.	MAX.
A0	10.5	10.7	0.413	0.421
B0	15.7	15.9	0.618	0.626
D	1.5	1.6	0.059	0.063
D1	1.59	1.61	0.062	0.063
E	1.65	1.85	0.065	0.073
F	11.4	11.6	0.449	0.456
K0	4.8	5.0	0.189	0.197
P0	3.9	4.1	0.153	0.161
P1	11.9	12.1	0.468	0.476
P2	1.9	2.1	0.075	0.082
R	50		1.574	
T	0.25	0.35	0.0098	0.0137
W	23.7	24.3	0.933	0.956

REEL MECHANICAL DATA

DIM.	mm		inch	
	MIN.	MAX.	MIN.	MAX.
A		330		12.992
B	1.5		0.059	
C	12.8	13.2	0.504	0.520
D	20.2		0.795	
G	24.4	26.4	0.960	1.039
N	100		3.937	
T		30.4		1.197

BASE QTY	BULK QTY
1000	1000

10 pitches cumulative tolerance on tape +/- 0.2 mm

FEED DIRECTION

Bending radius R min.

* on sales type

6 Revision history

Table 6. Revision history

Date	Revision	Changes
21-Jun-2004	1	First version
26-Jun-2006	2	New template, no content change

Please Read Carefully:

Information in this document is provided solely in connection with ST products. STMicroelectronics NV and its subsidiaries ("ST") reserve the right to make changes, corrections, modifications or improvements, to this document, and the products and services described herein at any time, without notice.

All ST products are sold pursuant to ST's terms and conditions of sale.

Purchasers are solely responsible for the choice, selection and use of the ST products and services described herein, and ST assumes no liability whatsoever relating to the choice, selection or use of the ST products and services described herein.

No license, express or implied, by estoppel or otherwise, to any intellectual property rights is granted under this document. If any part of this document refers to any third party products or services it shall not be deemed a license grant by ST for the use of such third party products or services, or any intellectual property contained therein or considered as a warranty covering the use in any manner whatsoever of such third party products or services or any intellectual property contained therein.

UNLESS OTHERWISE SET FORTH IN ST'S TERMS AND CONDITIONS OF SALE ST DISCLAIMS ANY EXPRESS OR IMPLIED WARRANTY WITH RESPECT TO THE USE AND/OR SALE OF ST PRODUCTS INCLUDING WITHOUT LIMITATION IMPLIED WARRANTIES OF MERCHANTABILITY, FITNESS FOR A PARTICULAR PURPOSE (AND THEIR EQUIVALENTS UNDER THE LAWS OF ANY JURISDICTION), OR INFRINGEMENT OF ANY PATENT, COPYRIGHT OR OTHER INTELLECTUAL PROPERTY RIGHT.

UNLESS EXPRESSLY APPROVED IN WRITING BY AN AUTHORIZED REPRESENTATIVE OF ST, ST PRODUCTS ARE NOT DESIGNED, AUTHORIZED OR WARRANTED FOR USE IN MILITARY, AIR CRAFT, SPACE, LIFE SAVING, OR LIFE SUSTAINING APPLICATIONS, NOR IN PRODUCTS OR SYSTEMS, WHERE FAILURE OR MALFUNCTION MAY RESULT IN PERSONAL INJURY, DEATH, OR SEVERE PROPERTY OR ENVIRONMENTAL DAMAGE.

Resale of ST products with provisions different from the statements and/or technical features set forth in this document shall immediately void any warranty granted by ST for the ST product or service described herein and shall not create or extend in any manner whatsoever, any liability of ST.

ST and the ST logo are trademarks or registered trademarks of ST in various countries.

Information in this document supersedes and replaces all information previously supplied.

The ST logo is a registered trademark of STMicroelectronics. All other names are the property of their respective owners.

© 2006 STMicroelectronics - All rights reserved

STMicroelectronics group of companies

Australia - Belgium - Brazil - Canada - China - Czech Republic - Finland - France - Germany - Hong Kong - India - Israel - Italy - Japan - Malaysia - Malta - Morocco - Singapore - Spain - Sweden - Switzerland - United Kingdom - United States of America

www.st.com

X-ON Electronics

Largest Supplier of Electrical and Electronic Components

Click to view similar products for [MOSFET](#) category:

Click to view products by [STMicroelectronics](#) manufacturer:

Other Similar products are found below :

[614233C](#) [648584F](#) [IRFD120](#) [JANTX2N5237](#) [FCA20N60_F109](#) [FDZ595PZ](#) [2SK2545\(Q,T\)](#) [405094E](#) [423220D](#) [TPCC8103,L1Q\(CM](#)
[MIC4420CM-TR](#) [VN1206L](#) [SBVS138LT1G](#) [614234A](#) [715780A](#) [NTNS3166NZT5G](#) [SSM6J414TU,LF\(T](#) [751625C](#) [BUK954R8-60E](#)
[NTE6400](#) [SQJ402EP-T1-GE3](#) [2SK2614\(TE16L1,Q\)](#) [2N7002KW-FAI](#) [DMN1017UCP3-7](#) [EFC2J004NUZTDG](#) [ECH8691-TL-W](#)
[FCAB21350L1](#) [P85W28HP2F-7071](#) [DMN1053UCP4-7](#) [NTE221](#) [NTE2384](#) [NTE2903](#) [NTE2941](#) [NTE2945](#) [NTE2946](#) [NTE2960](#) [NTE2967](#)
[NTE2969](#) [NTE2976](#) [NTE455](#) [NTE6400A](#) [NTE2910](#) [NTE2916](#) [NTE2956](#) [NTE2911](#) [DMN2080UCB4-7](#) [TK10A80W,S4X\(S](#)
[SSM6P69NU,LF](#) [DMP22D4UFO-7B](#) [DMN1006UCA6-7](#)