

Automotive power Schottky rectifier

Datasheet - production data

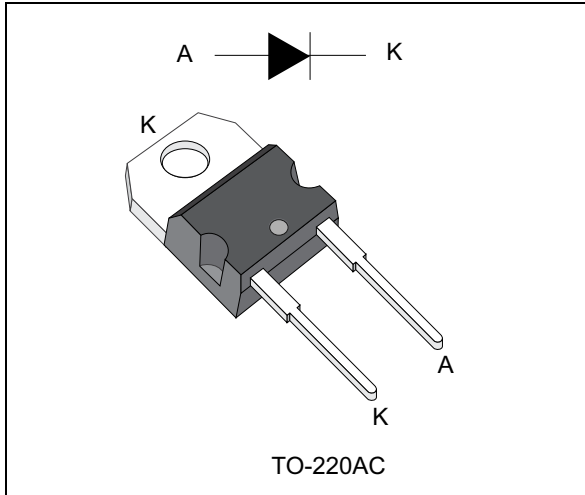

Description

Single chip Schottky rectifier suited for switch mode power supply and high frequency DC to DC converters.

Packaged in TO-220AC, this device is especially intended for use in low voltage, high frequency inverters, free wheeling and polarity protection in automotive applications.

Table 1. Device summary

Symbol	Value
$I_{F(AV)}$	15 A
V_{RRM}	45 V
T_j (max)	175 °C
V_F (typ)	0.50 V

Features

- Very small conduction losses
- Negligible switching losses
- Extremely fast switching
- Avalanche capability specified
- AECQ-101 qualified
- ECOPACK[®]2 compliant component

1 Characteristics

Table 2. Absolute ratings (limiting values)

Symbol	Parameter	Value	Unit
V_{RRM}	Repetitive peak reverse voltage	45	V
$I_{F(RMS)}$	Forward rms current	30	A
$I_{F(AV)}$	Average forward current $\delta = 0.5$	$T_c = 155\text{ }^\circ\text{C}$	A
I_{FSM}	Surge non repetitive forward current	$t_p = 10\text{ ms sinusoidal}$	A
I_{RRM}	Peak repetitive reverse current	$t_p = 2\text{ }\mu\text{s square}$ $F = 1\text{ kHz}$	A
I_{RSM}	Non repetitive peak reverse current	$t_p = 100\text{ }\mu\text{s square}$	A
$P_{ARM}^{(1)}$	Repetitive peak avalanche power	$T_j = 125\text{ }^\circ\text{C}, t_p = 10\text{ }\mu\text{s}$	W
T_{stg}	Storage temperature range	-65 to + 175	$^\circ\text{C}$
T_j	Operating junction temperature ⁽²⁾	-40 to + 175	$^\circ\text{C}$
dV/dt	Critical rate of rise of reverse voltage	10000	V/ μs

1. For pulse time duration deratings, please refer to [Figure 3](#). More details regarding the avalanche energy measurements and diode validation in the avalanche are provided in the STMicroelectronics Application notes AN1768, "Admissible avalanche power of Schottky diodes" and AN2025, "Converter improvement using Schottky rectifier avalanche specification".
2. $\frac{dP_{tot}}{dT_j} < \frac{1}{R_{th(j-a)}}$ condition to avoid thermal runaway for a diode on its own heatsink

Table 3. Thermal resistances

Symbol	Parameter	Value	Unit
$R_{th(j-c)}$	Junction to case	1.6	$^\circ\text{C/W}$

Table 4. Static electrical characteristics (per diode)

Symbol	Parameter	Test conditions	Min.	Typ.	Max.	Unit	
$I_R^{(1)}$	Reverse leakage current	$T_j = 25\text{ }^\circ\text{C}$	$V_R = V_{RRM}$	-	-	200	μA
		$T_j = 125\text{ }^\circ\text{C}$		-	11	40	mA
$V_F^{(1)}$	Forward voltage drop	$T_j = 125\text{ }^\circ\text{C}$	$I_F = 15\text{ A}$	-	0.5	0.57	V
		$T_j = 25\text{ }^\circ\text{C}$	$I_F = 30\text{ A}$	-	-	0.84	
		$T_j = 125\text{ }^\circ\text{C}$	$I_F = 30\text{ A}$	-	0.65	0.72	

1. Pulse test: $t_p = 380\text{ }\mu\text{s}, \delta < 2\%$

To evaluate the conduction losses use the following equation:

$$P = 0.42 \times I_{F(AV)} + 0.01 I_{F(RMS)}^2$$

Figure 1. Average forward power dissipation versus average forward current

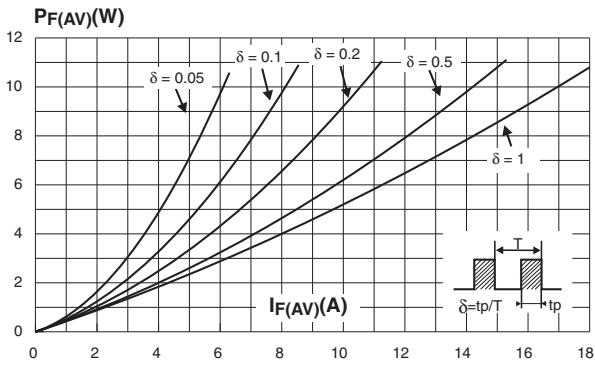

Figure 2. Average forward current versus ambient temperature ($\delta = 0.5$)

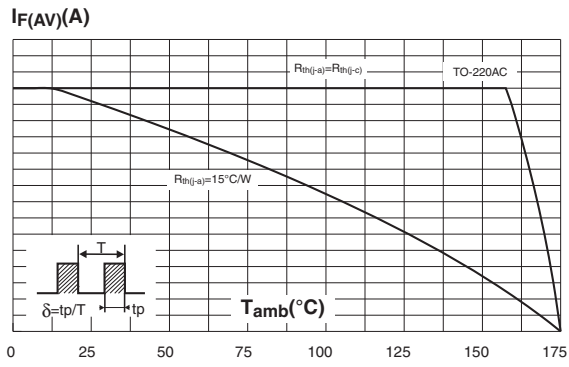

Figure 3. Normalized avalanche power deratings versus pulse duration ($T_j = 125^\circ\text{C}$)

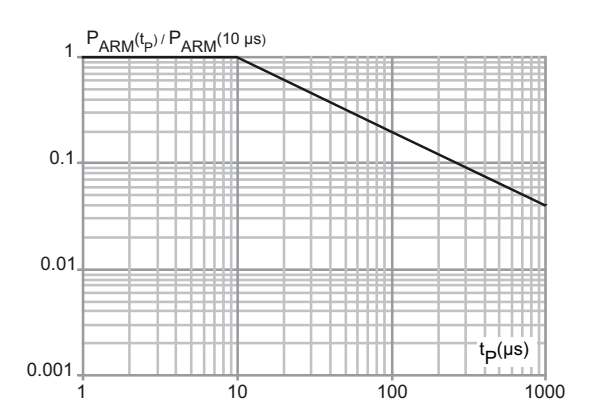

Figure 4. Relative variation of thermal impedance junction to case versus pulse duration

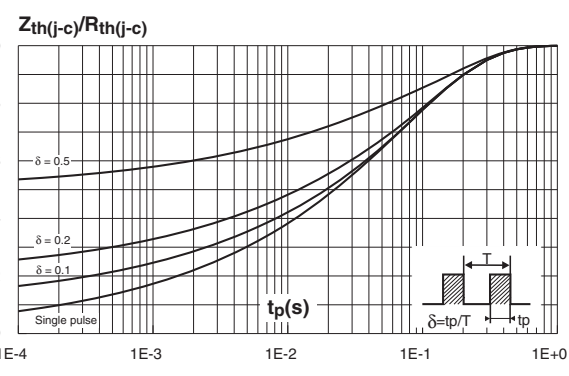

Figure 5. Reverse leakage current versus reverse voltage applied (typical values)

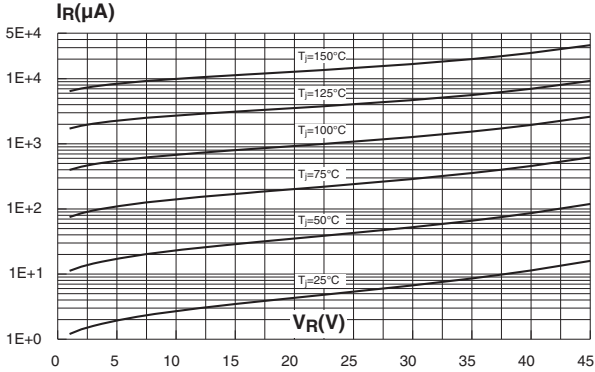

Figure 6. Junction capacitance versus reverse voltage applied (typical values)

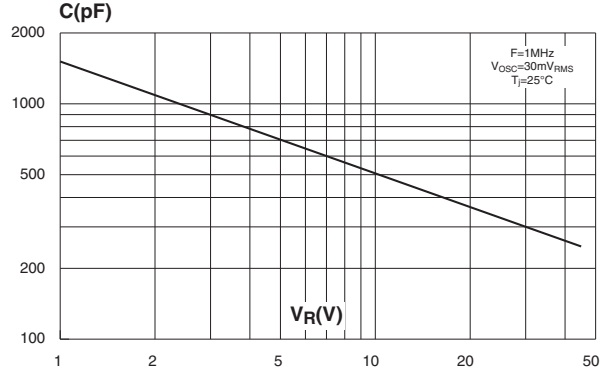
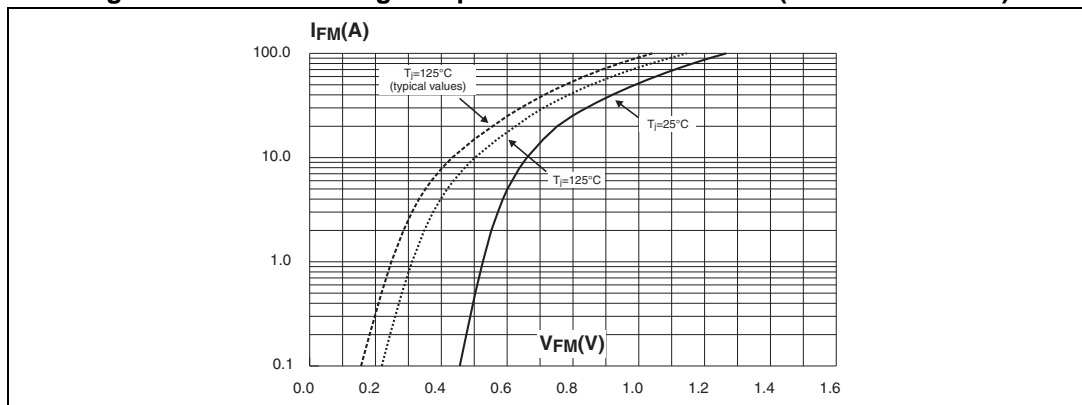

Figure 7. Forward voltage drop versus forward current (maximum values)



2 Package information

- Epoxy meets UL94, V0
- Cooling method: by conduction (C)
- Recommended torque value: 0.55 N·m
- Maximum torque value: 0.7 N·m

In order to meet environmental requirements, ST offers these devices in different grades of ECOPACK® packages, depending on their level of environmental compliance. ECOPACK® specifications, grade definitions and product status are available at: www.st.com. ECOPACK® is an ST trademark.

2.1 TO-220AC package information

Figure 8. TO-220AC package outline

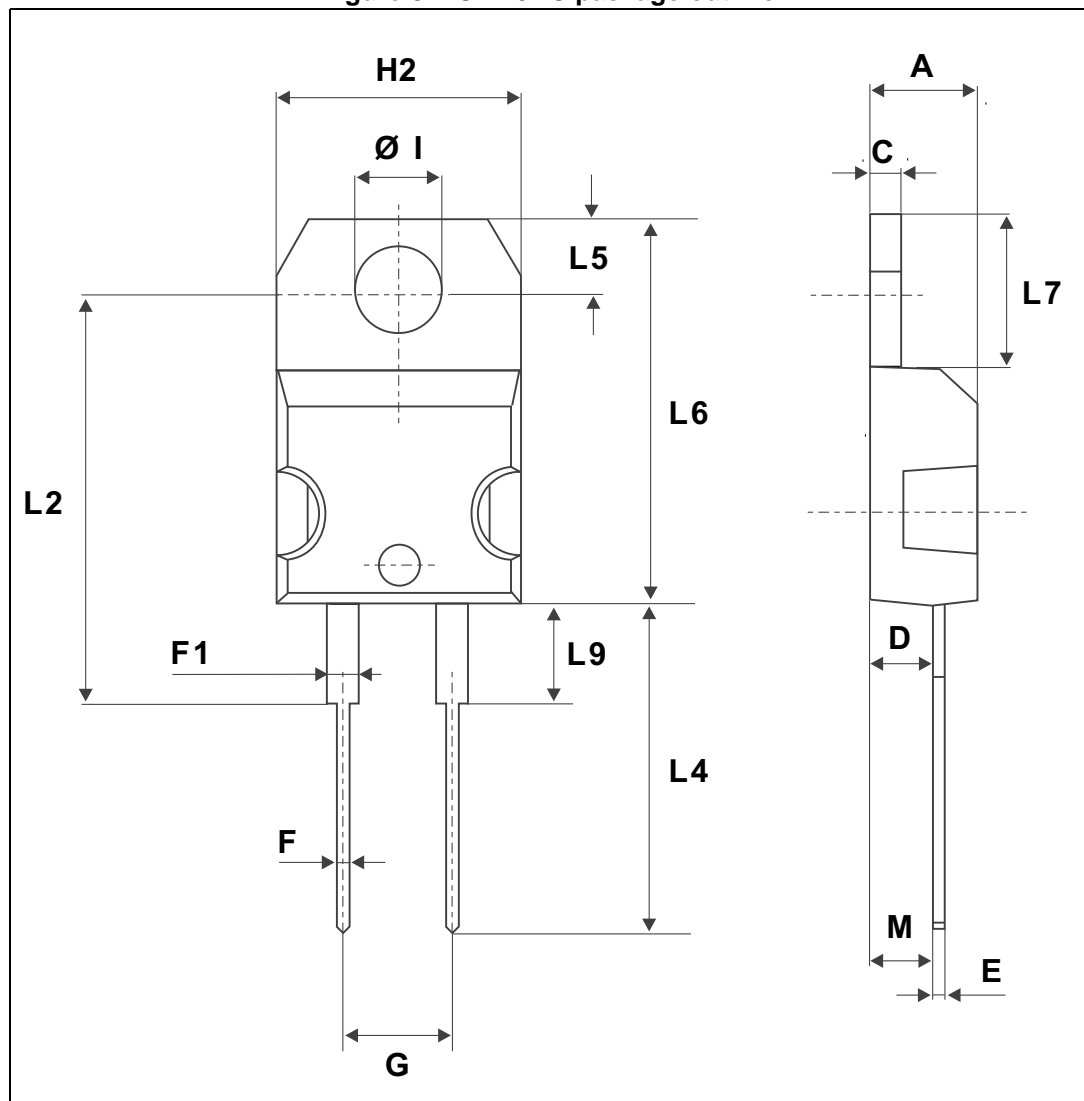

Table 5. TO-220AC package mechanical data

Ref.	Dimensions					
	Millimeters			Inches		
	Min.	Typ.	Max.	Min.	Typ.	Max.
A	4.40		4.60	0.173		0.181
C	1.23		1.32	0.048		0.051
D	2.40		2.72	0.094		0.107
E	0.49		0.70	0.019		0.027
F	0.61		0.88	0.024		0.034
F1	1.14		1.70	0.044		0.066
G	4.95		5.15	0.194		0.202
H2	10.00		10.40	0.393		0.409
L2		16.40 typ.			0.645 typ.	
L4	13.00		14.00	0.511		0.551
L5	2.65		2.95	0.104		0.116
L6	15.25		15.75	0.600		0.620
L7	6.20		6.60	0.244		0.259
L9	3.50		3.93	0.137		0.154
M		2.6 typ.			0.102 typ.	
Diam. I	3.75		3.85	0.147		0.151

3 Ordering information

Table 6. Ordering information

Order codes	Marking	Package	Weight	Base qty	Delivery mode
STPS1545DY	STPS1545DY	TO-220AC	1.86 mg	50	Tube

4 Revision history

Table 7. Document revision history

Date	Revision	Changes
29-Oct-2012	1	First issue.
02-May-2016	2	Added pin name on package view and reformatted to current standards.

IMPORTANT NOTICE – PLEASE READ CAREFULLY

STMicroelectronics NV and its subsidiaries (“ST”) reserve the right to make changes, corrections, enhancements, modifications, and improvements to ST products and/or to this document at any time without notice. Purchasers should obtain the latest relevant information on ST products before placing orders. ST products are sold pursuant to ST’s terms and conditions of sale in place at the time of order acknowledgement.

Purchasers are solely responsible for the choice, selection, and use of ST products and ST assumes no liability for application assistance or the design of Purchasers’ products.

No license, express or implied, to any intellectual property right is granted by ST herein.

Resale of ST products with provisions different from the information set forth herein shall void any warranty granted by ST for such product.

ST and the ST logo are trademarks of ST. All other product or service names are the property of their respective owners.

Information in this document supersedes and replaces information previously supplied in any prior versions of this document.

© 2016 STMicroelectronics – All rights reserved

X-ON Electronics

Largest Supplier of Electrical and Electronic Components

Click to view similar products for [Schottky Diodes & Rectifiers](#) category:

Click to view products by [STMicroelectronics](#) manufacturer:

Other Similar products are found below :

[MA4E2039](#) [D1FH3-5063](#) [MBR0530L-TP](#) [MBR10100CT-BP](#) [MBR1545CT](#) [MMBD301M3T5G](#) [RB160M-50TR](#) [RB551V-30](#)
[BAS16E6433HTMA1](#) [BAT 54-02LRH E6327](#) [NSR05F40QNXT5G](#) [NTE555](#) [JANS1N6640](#) [SB07-03C-TB-H](#) [SB1003M3-TL-W](#) [SK310-T](#)
[SK32A-LTP](#) [SK33A-TP](#) [SK34B-TP](#) [SS3003CH-TL-E](#) [GA01SHT18](#) [CRS10I30A\(TE85L,QM](#) [MA4E2501L-1290](#) [MBRB30H30CT-1G](#)
[SB007-03C-TB-E](#) [SK32A-TP](#) [SK33B-TP](#) [SK35A-TP](#) [SK38B-TP](#) [NRVBM120LT1G](#) [NTE505](#) [NTSB30U100CT-1G](#) [SS15E-TP](#) [VS-](#)
[6CWQ10FNHM3](#) [ACDBA1100LR-HF](#) [ACDBA1200-HF](#) [ACDBA140-HF](#) [ACDBA2100-HF](#) [ACDBA3100-HF](#) [CDBQC0530L-HF](#)
[CDBQC0240LR-HF](#) [ACDBA340-HF](#) [ACDBA260LR-HF](#) [ACDBA1100-HF](#) [SK310B-TP](#) [MA4E2502L-1246](#) [MA4E2502H-1246](#)
[NRVBM120ET1G](#) [NSR01L30MXT5G](#) [NTE573](#)