

100 V, 2 A power Schottky rectifier

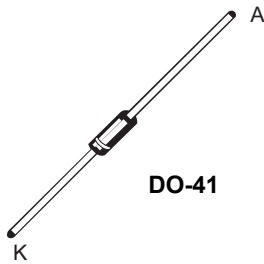

Features

- Negligible switching losses
- High junction temperature capability
- Low leakage current
- Good trade-off between leakage current and forward voltage drop
- Avalanche capability specified
- ECOPACK2 compliant

Applications

- Switching diode
- LED lighting
- DC/DC converter

Description

The [STPS2H100RL](#) is an axial power Schottky rectifier ideal for switch mode power supply and high frequency DC/DC converters.

Packaged in DO-41, this device is optimized for use in low voltage, high frequency inverters and small battery chargers.

Product status link

[STPS2H100RL](#)

Product summary

Symbol	Value
$I_{F(AV)}$	2 A
V_{RRM}	100 V
T_j (max.)	175 °C
V_F (max.)	0.70 V

1 Characteristics

Table 1. Absolute ratings (limiting values at 25 °C, unless otherwise specified)

Symbol	Parameter		Value	Unit
V _{RRM}	Repetitive peak reverse voltage		100	V
I _{F(AV)}	Average forward current	T _L = 120 °C, δ = 0.5	2	A
I _{FSM}	Surge non repetitive forward current	t _p = 10 ms sinusoidal	50	A
P _{ARM}	Repetitive peak avalanche power	t _p = 10 μs, T _j = 125 °C	108	W
T _{stg}	Storage temperature range		-65 to +175	°C
T _j	Maximum operating junction temperature ⁽¹⁾		175	°C

1. $(dP_{tot}/dT_j) < (1/R_{th(j-a)})$ condition to avoid thermal runaway for a diode on its own heatsink.

Table 2. Thermal resistance parameters

Symbol	Parameter		Max. value	Unit
R _{th(j-a)}	Junction to ambient	Lead length = 10 mm	100	°C/W
R _{th(j-l)}	Junction to lead		35	

For more information, please refer to the following application note :

- AN5088 : Rectifiers thermal management, handling and mounting recommendations

Table 3. Static electrical characteristics

Symbol	Parameter	Test conditions		Min.	Typ.	Max.	Unit
I _R ⁽¹⁾	Reverse leakage current	T _j = 25 °C	V _R = V _{RRM}	-		1	μA
		T _j = 125 °C		-	0.2	0.5	mA
V _F ⁽²⁾	Forward voltage drop	T _j = 25 °C	I _F = 2 A	-		0.86	V
		T _j = 125 °C		-	0.65	0.70	
		T _j = 25 °C	I _F = 4 A	-		0.92	
		T _j = 125 °C		-	0.72	0.78	

1. Pulse test: t_p = 5 ms, δ < 2%

2. Pulse test: t_p = 380 μs, δ < 2%

To evaluate the conduction losses, use the following equation:

$$P = 0.62 \times I_{F(AV)} + 0.04 \times I_{F(RMS)}^2$$

For more information, please refer to the following application notes related to the power losses :

- AN604: Calculation of conduction losses in a power rectifier
- AN4021: Calculation of reverse losses on a power diode.

1.1 Characteristics (curves)

Figure 1. Average forward power dissipation versus average forward current

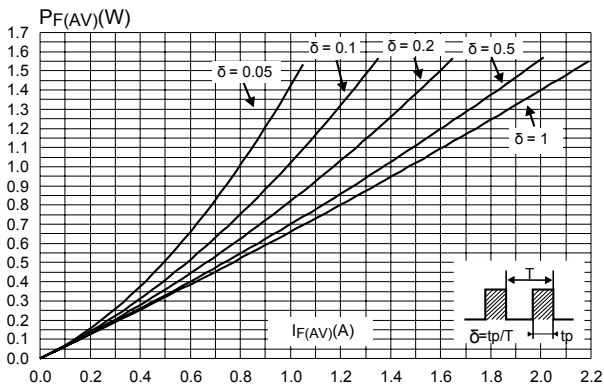

Figure 2. Average forward current versus ambient temperature ($\delta = 0.5$)

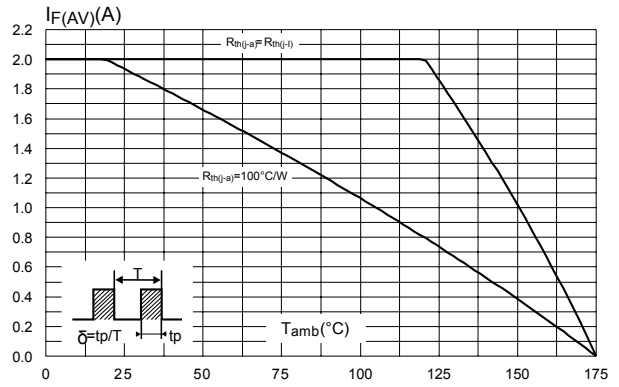

Figure 3. Normalized avalanche power derating versus junction temperature ($T_j = 125^\circ\text{C}$)

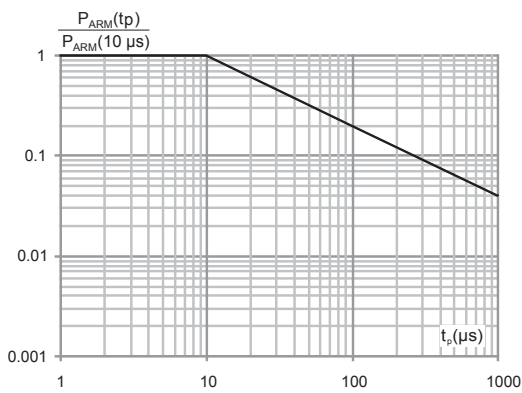

Figure 4. Relative variation of thermal impedance junction to ambient versus pulse duration

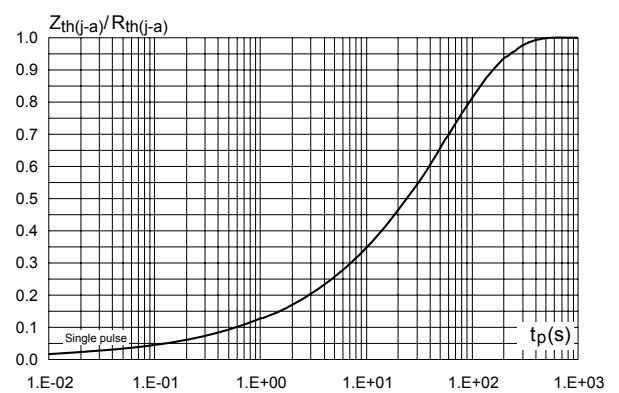

Figure 5. Reverse leakage current versus reverse voltage applied (typical values)

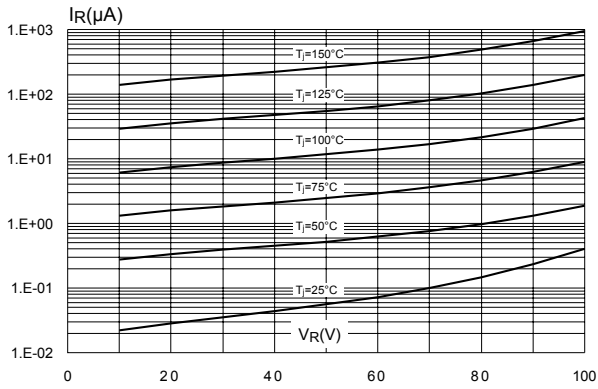

Figure 6. Junction capacitance versus reverse voltage applied (typical values)

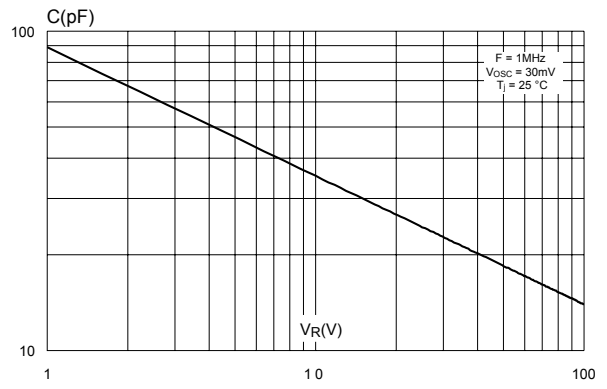

Figure 7. Forward voltage drop versus forward current (low level)

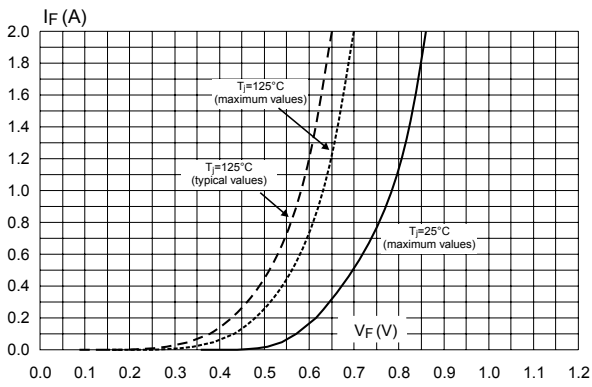

Figure 8. Forward voltage drop versus forward current (high level)

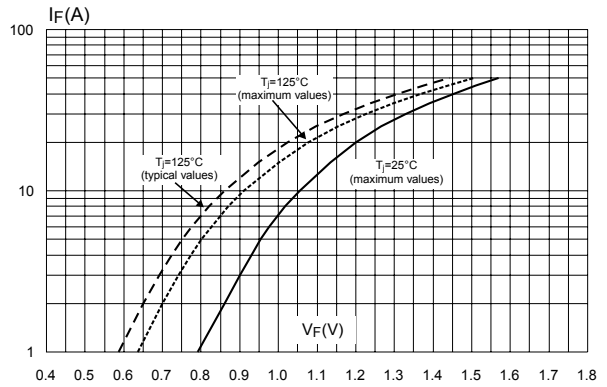
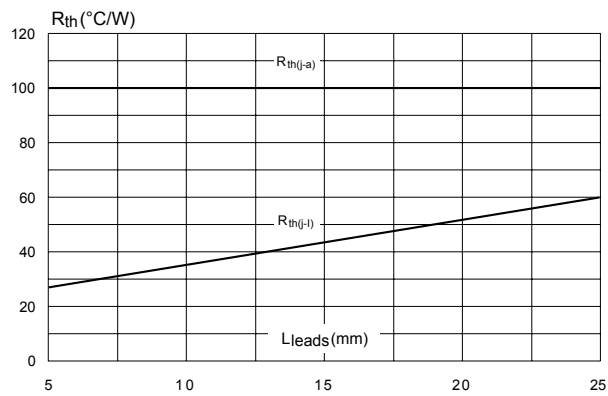

Figure 9. Thermal resistance versus lead length



2 Package information

In order to meet environmental requirements, ST offers these devices in different grades of **ECOPACK** packages, depending on their level of environmental compliance. ECOPACK specifications, grade definitions and product status are available at: www.st.com. ECOPACK is an ST trademark.

2.1 DO-41 package information

- Epoxy meets UL94, V0
- Band indicates cathode

Figure 10. DO-41 package outline

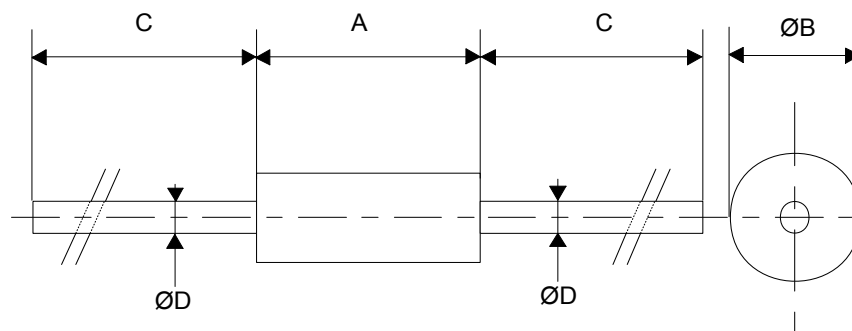

Table 4. DO-41 package mechanical data

Ref.	Dimensions			
	Millimeters		Inches	
	Min.	Max.	Min.	Max.
A	4.07	5.20	0.160	0.205
ØB	2.04	2.71	0.080	0.107
C	25.40		1	
ØD	0.71	0.86	0.028	0.034

3 Ordering Information

Table 5. Ordering information

Order code	Marking	Package	Weight	Base qty.	Delivery mode
STPS2H100	STPS2H100 Cathode ring	DO-41	0.34 g	2000	Ammopack

Revision history

Table 6. Document revision history

Date	Version	Changes
Jul-2003	2A	Initial release.
23-Jun-2009	3	Updated dimension C in table 5.
05-Oct-2009	4	Updated table 5 package dimensions.
17-May-2018	5	Removed figure 4 and figure 5. Updated Figure 3. Normalized avalanche power derating versus junction temperature ($T_j = 125\text{ °C}$) and Table 1. Absolute ratings (limiting values at 25 °C, unless otherwise specified). Minor text changes to improve readability.
01-Apr-2020	6	Updated Table 5. Ordering information.

IMPORTANT NOTICE – PLEASE READ CAREFULLY

STMicroelectronics NV and its subsidiaries (“ST”) reserve the right to make changes, corrections, enhancements, modifications, and improvements to ST products and/or to this document at any time without notice. Purchasers should obtain the latest relevant information on ST products before placing orders. ST products are sold pursuant to ST’s terms and conditions of sale in place at the time of order acknowledgement.

Purchasers are solely responsible for the choice, selection, and use of ST products and ST assumes no liability for application assistance or the design of Purchasers’ products.

No license, express or implied, to any intellectual property right is granted by ST herein.

Resale of ST products with provisions different from the information set forth herein shall void any warranty granted by ST for such product.

ST and the ST logo are trademarks of ST. For additional information about ST trademarks, please refer to www.st.com/trademarks. All other product or service names are the property of their respective owners.

Information in this document supersedes and replaces information previously supplied in any prior versions of this document.

© 2020 STMicroelectronics – All rights reserved

X-ON Electronics

Largest Supplier of Electrical and Electronic Components

Click to view similar products for [Schottky Diodes & Rectifiers](#) category:

Click to view products by [STMicroelectronics](#) manufacturer:

Other Similar products are found below :

[MA4E2039](#) [D1FH3-5063](#) [MBR0530L-TP](#) [MBR10100CT-BP](#) [MBR1545CT](#) [MMBD301M3T5G](#) [RB160M-50TR](#) [RB551V-30](#)
[BAS16E6433HTMA1](#) [BAT 54-02LRH E6327](#) [NSR05F40QNXT5G](#) [NTE555](#) [JANS1N6640](#) [SB07-03C-TB-H](#) [SB1003M3-TL-W](#) [SK310-T](#)
[SK32A-LTP](#) [SK33A-TP](#) [SK34B-TP](#) [SS3003CH-TL-E](#) [GA01SHT18](#) [CRS10I30A\(TE85L,QM](#) [MA4E2501L-1290](#) [MBRB30H30CT-1G](#)
[SB007-03C-TB-E](#) [SK32A-TP](#) [SK33B-TP](#) [SK35A-TP](#) [SK38B-TP](#) [NRVBM120LT1G](#) [NTE505](#) [NTSB30U100CT-1G](#) [SS15E-TP](#) [VS-](#)
[6CWQ10FNHM3](#) [ACDBA1100LR-HF](#) [ACDBA1200-HF](#) [ACDBA140-HF](#) [ACDBA2100-HF](#) [ACDBA3100-HF](#) [CDBQC0530L-HF](#)
[CDBQC0240LR-HF](#) [ACDBA340-HF](#) [ACDBA260LR-HF](#) [ACDBA1100-HF](#) [SK310B-TP](#) [MA4E2502L-1246](#) [MA4E2502H-1246](#)
[NRVBM120ET1G](#) [NSR01L30MXT5G](#) [NTE573](#)