

Low drop power Schottky rectifier

Features

- low forward voltage drop meaning very small conduction losses
- low switching losses allowing high frequency operation
- low thermal resistance
- avalanche rated
- insulated package TO-220FPAB:
 - insulating voltage = 2000 V DC
 - capacitance = 45 pF
- avalanche capability specified

Description

Dual center tap Schottky rectifier suited for switched mode power supplies and high frequency DC to DC converters.

Packaged in TO-247, TO-220AB, TO-220FPAB, D²PAK and I²PAK this device is intended for use in low voltage, high frequency inverters, free wheeling and polarity protection applications.

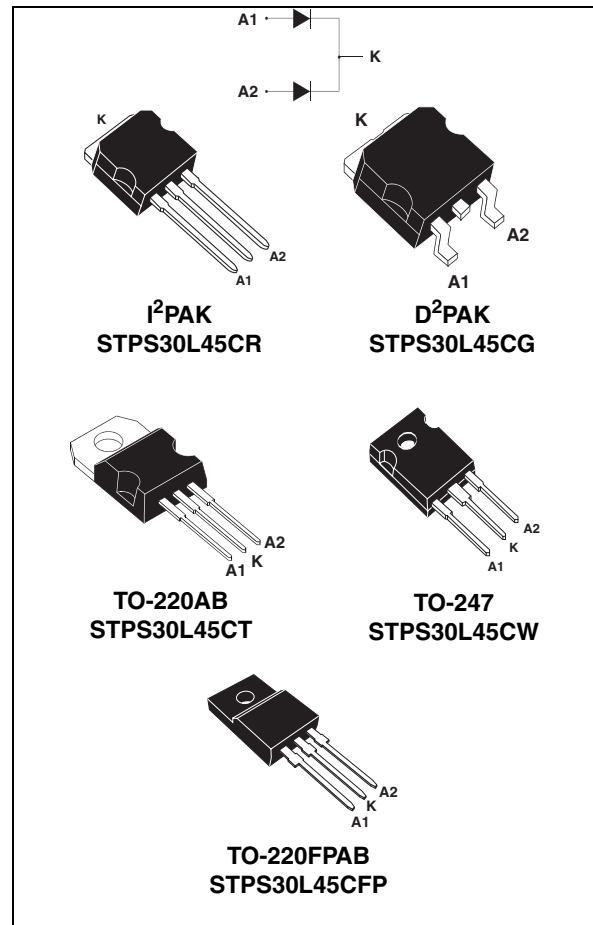

Table 1. Device summary

$I_{F(AV)}$	2 x 15 A
V_{RRM}	45 V
T_j (max)	150 °C
V_F (max)	0.5 V

1 Characteristics

Table 2. Absolute Ratings (limiting values, per diode)

Symbol	Parameter			Value	Unit	
V _{RRM}	Repetitive peak reverse voltage			45	V	
I _{F(RMS)}	Forward rms current			30	A	
I _{F(AV)}	Average forward current	TO-220FPAB	T _c = 110 °C, δ = 0.5	Per diode Per device	15 30	A
		TO-220AB, TO-247, I ² PAK, D ₂ PAK	T _c = 135 °C, δ = 0.5			
I _{FSM}	Surge non repetitive forward current		t _p = 10 ms Sinusoidal	220	A	
I _{RRM}	Repetitive peak reverse current		t _p = 2 μs square F = 1 kHz	1	A	
I _{RSM}	Non repetitive peak reverse current		t _p = 100 μs square	3	A	
P _{ARM}	Repetitive peak avalanche power		t _p = 1 μs T _j = 25 °C	6000	W	
T _{stg}	Storage temperature range			-65 to + 150	°C	
T _j	Maximum operating junction temperature ⁽¹⁾			150	°C	
dV/dt	Critical rate of rise of reverse voltage			10000	V/μs	

1. $\frac{dP_{tot}}{dT_j} < \frac{1}{R_{th(j-a)}}$ condition to avoid thermal runaway for a diode on its own heatsink

Table 3. Thermal resistances

Symbol	Parameter			Value	Unit
R _{th(j-c)}	Junction to case	TO-220FPAB	Per diode	4	°C/W
			Total	3.2	
		TO-220AB, TO-247, I ² PAK, D ² PAK	Per diode	1.60	
			Total	0.85	
R _{th(c)}	Coupling	TO-220FPAB	2.5	°C/W	
		TO-220AB, TO-247, I ² PAK, D ² PAK	0.10		

When the diodes 1 and 2 are used simultaneously:

$$\Delta T_j(\text{diode 1}) = P(\text{diode1}) \times R_{th(j-c)}(\text{Per diode}) + P(\text{diode 2}) \times R_{th(c)}$$

Table 4. Static electrical characteristics (per diode)

Symbol	Parameter	Test Conditions		Min.	Typ.	Max.	Unit
$I_R^{(1)}$	Reverse leakage current	$T_j = 25\text{ }^\circ\text{C}$	$V_R = V_{RRM}$			0.4	mA
		$T_j = 125\text{ }^\circ\text{C}$			100	200	mA
$V_F^{(1)}$	Forward voltage drop	$T_j = 25\text{ }^\circ\text{C}$	$I_F = 15\text{ A}$			0.55	V
		$T_j = 125\text{ }^\circ\text{C}$	$I_F = 15\text{ A}$		0.42	0.50	
		$T_j = 25\text{ }^\circ\text{C}$	$I_F = 30\text{ A}$			0.74	
		$T_j = 125\text{ }^\circ\text{C}$	$I_F = 30\text{ A}$		0.59	0.67	

1. Pulse test: $t_p = 380\text{ }\mu\text{s}$, $\delta < 2\%$

To evaluate the conduction losses use the following equation: $P = 0.330 \times I_{F(AV)} + 0.011 I_F^2_{(RMS)}$

Figure 1. Average forward power dissipation versus average forward current (per diode)

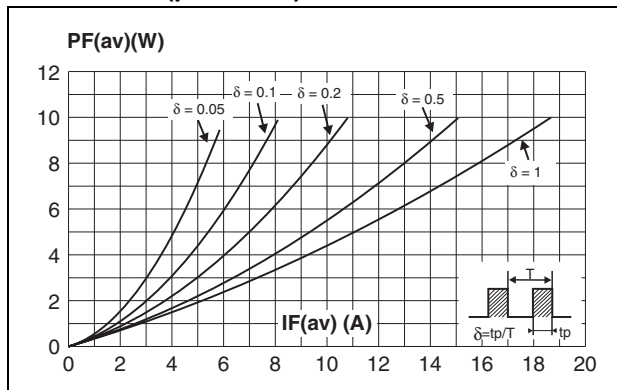

Figure 2. Average forward current versus ambient temperature (delta = 0.5, per diode)

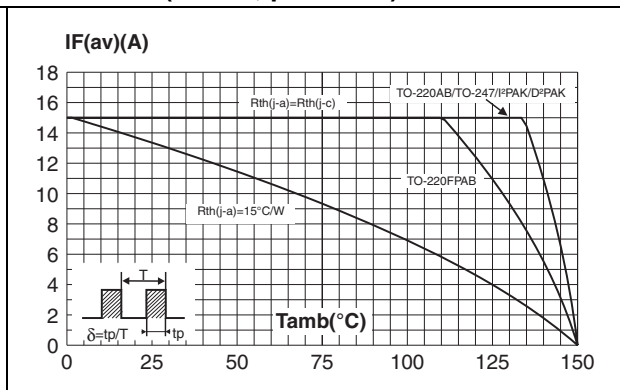

Figure 3. Normalized avalanche power derating versus pulse duration

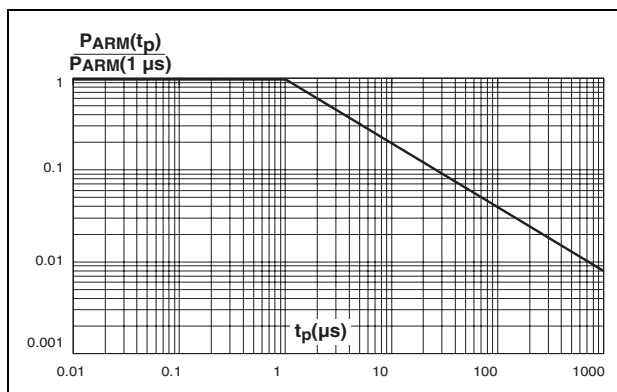

Figure 4. Normalized avalanche power derating versus junction temperature

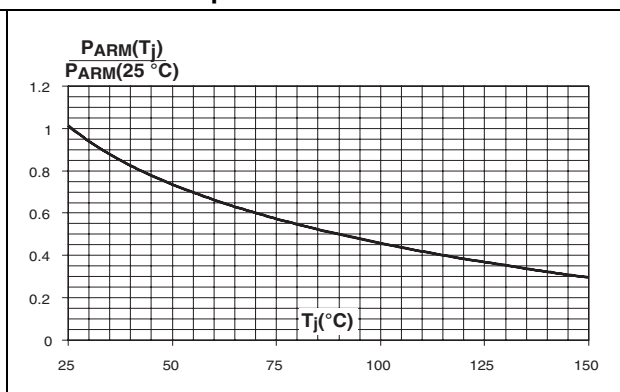

Figure 5. Non repetitive surge peak forward current versus overload duration

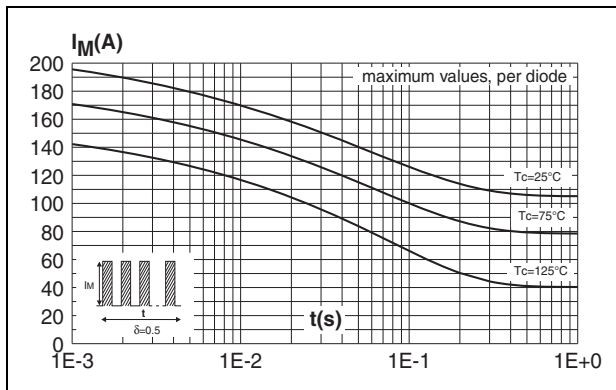

Figure 6. Non repetitive surge peak forward current versus overload duration (TO-220FPAB only)

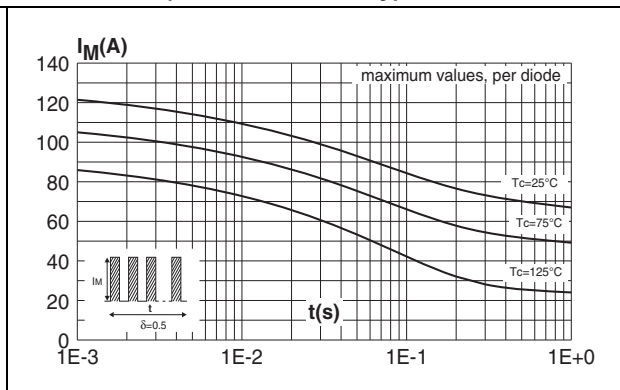

Figure 7. Relative variation of thermal impedance junction to case versus pulse duration

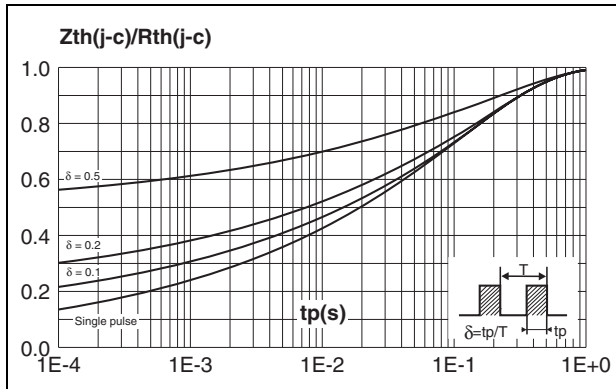

Figure 8. Relative variation of thermal impedance junction to case versus pulse duration (TO-220FPAB)

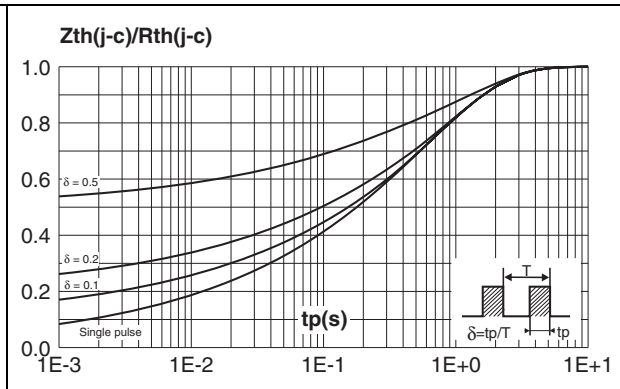

Figure 9. Reverse leakage current versus reverse voltage applied (typical values, per diode)

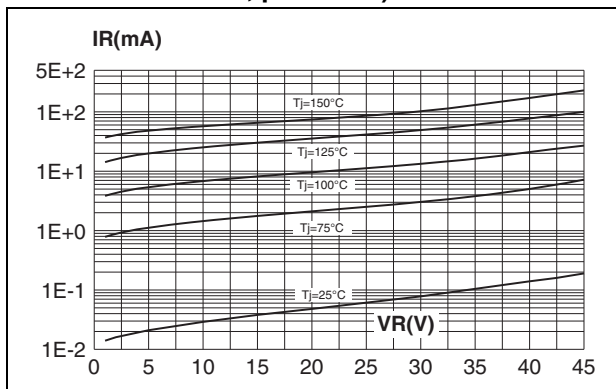

Figure 10. Junction capacitance versus reverse voltage applied (typical values, per diode)

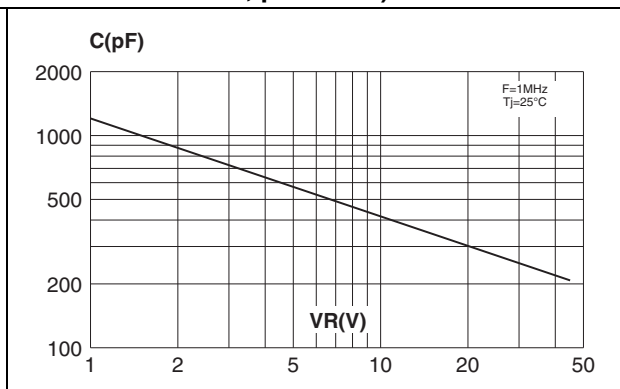

Figure 11. Forward voltage drop versus forward current (maximum values, per diode)

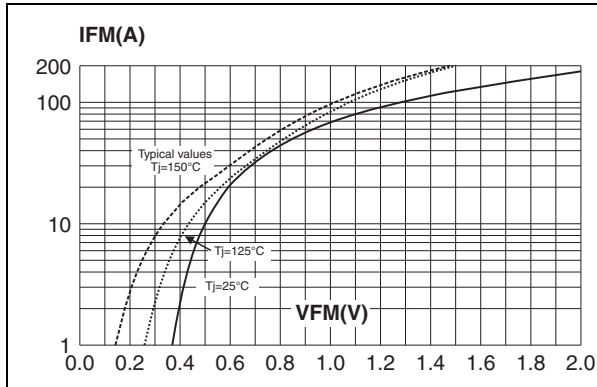
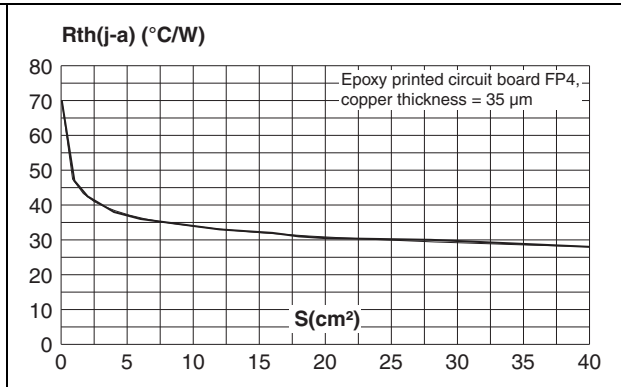

Figure 12. Thermal resistance junction to ambient versus copper surface under tab for D²PAK



2 Package Information

- Epoxy meets UL94, V0
- Cooling method: by conduction (C)
- Recommended torque (TO-220AB, TO-220FPAB): 0.4 to 0.6 N-m

In order to meet environmental requirements, ST offers these devices in different grades of ECOPACK® packages, depending on their level of environmental compliance. ECOPACK® specifications, grade definitions and product status are available at: www.st.com. ECOPACK® is an ST trademark.

Table 5. TO-220AB package dimensions

Ref	Dimensions			
	Millimeters		Inches	
	Min.	Max.	Min.	Max.
A	4.40	4.60	0.173	0.181
C	1.23	1.32	0.048	0.051
D	2.40	2.72	0.094	0.107
E	0.49	0.70	0.019	0.027
F	0.61	0.88	0.024	0.034
F1	1.14	1.70	0.044	0.066
F2	1.14	1.70	0.044	0.066
G	4.95	5.15	0.194	0.202
G1	2.40	2.70	0.094	0.106
H2	10	10.40	0.393	0.409
L2	16.4 typ.		0.645 typ.	
L4	13	14	0.511	0.551
L5	2.65	2.95	0.104	0.116
L6	15.25	15.75	0.600	0.620
L7	6.20	6.60	0.244	0.259
L9	3.50	3.93	0.137	0.154
M	2.6 typ.		0.102 typ.	
Dia.	3.75	3.85	0.147	0.151

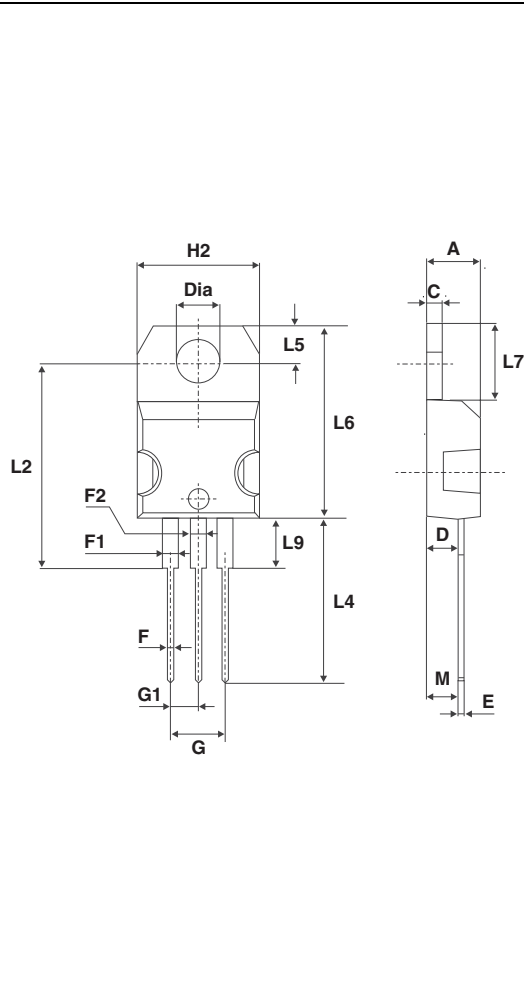

Mounting (soldering) the I²PAK metal slug (heatsink) with alloy, like a surface mount device, IS NOT PERMITTED. A standard through-hole mounting is mandatory.

Table 6. I²PAK dimensions

Ref.	Dimensions			
	Millimeters		Inches	
	Min.	Max.	Min.	Max.
A	4.40	4.60	0.173	0.181
A1	2.40	2.72	0.094	0.107
b	0.61	0.88	0.024	0.035
b1	1.14	1.70	0.044	0.067
c	0.49	0.70	0.019	0.028
c2	1.23	1.32	0.048	0.052
D	8.95	9.35	0.352	0.368
e	2.40	2.70	0.094	0.106
e1	4.95	5.15	0.195	0.203
E	10	10.40	0.394	0.409
L	13	14	0.512	0.551
L1	3.50	3.93	0.138	0.155
L2	1.27	1.40	0.050	0.055

Table 7. TO-220FPAB package dimensions

Ref	Dimensions			
	Millimeters		Inches	
	Min.	Max.	Min.	Max.
A	4.4	4.6	0.173	0.181
B	2.5	2.7	0.098	0.106
D	2.5	2.75	0.098	0.108
E	0.45	0.70	0.018	0.027
F	0.75	1	0.030	0.039
F1	1.15	1.70	0.045	0.067
F2	1.15	1.70	0.045	0.067
G	4.95	5.20	0.195	0.205
G1	2.4	2.7	0.094	0.106
H	10	10.4	0.393	0.409
L2	16 Typ.		0.63 Typ.	
L3	28.6	30.6	1.126	1.205
L4	9.8	10.6	0.386	0.417
L5	2.9	3.6	0.114	0.142
L6	15.9	16.4	0.626	0.646
L7	9.00	9.30	0.354	0.366
Dia.	3.00	3.20	0.118	0.126

Table 8. D²PAK package dimensions

Ref	Dimensions			
	Millimeters		Inches	
	Min.	Max.	Min.	Max.
A	4.40	4.60	0.173	0.181
A1	2.49	2.69	0.098	0.106
A2	0.03	0.23	0.001	0.009
B	0.70	0.93	0.027	0.037
B2	1.14	1.70	0.045	0.067
C	0.45	0.60	0.017	0.024
C2	1.23	1.36	0.048	0.054
D	8.95	9.35	0.352	0.368
E	10.00	10.40	0.393	0.409
G	4.88	5.28	0.192	0.208
L	15.00	15.85	0.590	0.624
L2	1.27	1.40	0.050	0.055
L3	1.40	1.75	0.055	0.069
M	2.40	3.20	0.094	0.126
R	0.40 typ.		0.016 typ.	
V2	0°	8°	0°	8°

Figure 13. D²PAK footprint dimensions (in millimeters)

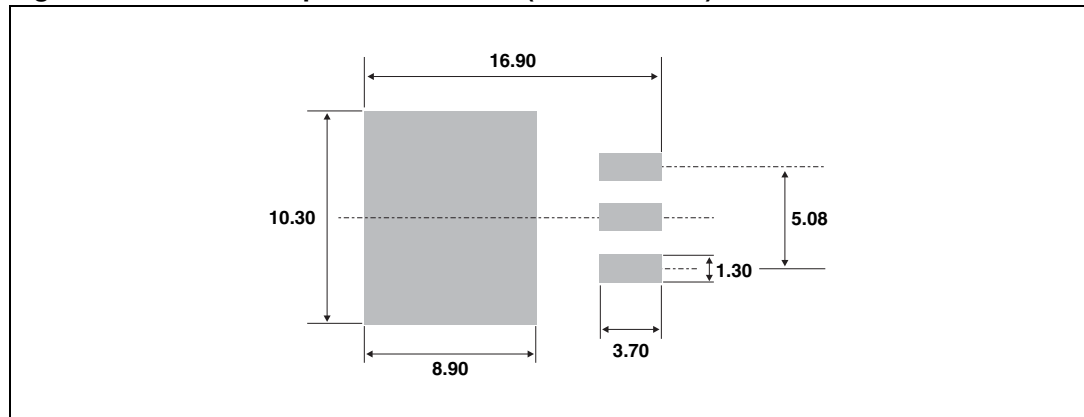

Table 9. TO-247 dimensions

Ref.	Dimensions			
	Millimeters		Inches	
	Min.	Max.	Min.	Max.
A	4.85	5.15	0.191	0.203
A1	2.20	2.60	0.086	0.102
b	1.00	1.40	0.039	0.055
b1	2.00	2.40	0.078	0.094
b2	3.00	3.40	0.118	0.133
c	0.40	0.80	0.015	0.031
D ⁽¹⁾	19.85	20.15	0.781	0.793
E	15.45	15.75	0.608	0.620
e	5.45 typ.		0.215 typ.	
L	14.20	14.80	0.559	0.582
L1	3.70	4.30	0.145	0.169
L2	18.50 typ.		0.728 typ.	
ØP ⁽²⁾	3.55	3.65	0.139	0.143
ØR	4.50	5.50	0.177	0.217
S	5.50 typ.		0.216 typ.	

1. Dimension D plus gate protrusion does not exceed 20.5 mm
2. Resin thickness around the mounting hole is not less than 0.9 mm

3 Ordering Information

Table 10. Ordering information

Order code	Marking	Package	Weight	Base qty	Delivery mode
STPS30L45CT	STPS30L45CT	TO-220AB	2g	50	Tube
STPS30L45CG	STPS30L45CG	D ² PAK	1.8g	50	Tube
STPS30L45CG-TR	STPS30L45CG	D ² PAK	1.8g	500	Tape and reel
STPS30L45CW	STPS30L45CW	TO-247	4.4g	30	Tube
STPS30L45CR	STPS30L45CR	I ² PAK	1.4g	50	Tube
STPS30L45CFP	STPS30L45CFP	TO-220FPAB	1.9 g	50	Tube

4 Revision history

Table 11. Document revision history

Date	Revision	Changes
Jul-2003	3B	Previous issue
13-Oct-2010	4	Added paragraph above Table 6 and updated I ² PAK dimensions in Table 6 . Updated TO-247 dimensions in Table 9 .

Please Read Carefully:

Information in this document is provided solely in connection with ST products. STMicroelectronics NV and its subsidiaries ("ST") reserve the right to make changes, corrections, modifications or improvements, to this document, and the products and services described herein at any time, without notice.

All ST products are sold pursuant to ST's terms and conditions of sale.

Purchasers are solely responsible for the choice, selection and use of the ST products and services described herein, and ST assumes no liability whatsoever relating to the choice, selection or use of the ST products and services described herein.

No license, express or implied, by estoppel or otherwise, to any intellectual property rights is granted under this document. If any part of this document refers to any third party products or services it shall not be deemed a license grant by ST for the use of such third party products or services, or any intellectual property contained therein or considered as a warranty covering the use in any manner whatsoever of such third party products or services or any intellectual property contained therein.

UNLESS OTHERWISE SET FORTH IN ST'S TERMS AND CONDITIONS OF SALE ST DISCLAIMS ANY EXPRESS OR IMPLIED WARRANTY WITH RESPECT TO THE USE AND/OR SALE OF ST PRODUCTS INCLUDING WITHOUT LIMITATION IMPLIED WARRANTIES OF MERCHANTABILITY, FITNESS FOR A PARTICULAR PURPOSE (AND THEIR EQUIVALENTS UNDER THE LAWS OF ANY JURISDICTION), OR INFRINGEMENT OF ANY PATENT, COPYRIGHT OR OTHER INTELLECTUAL PROPERTY RIGHT.

UNLESS EXPRESSLY APPROVED IN WRITING BY AN AUTHORIZED ST REPRESENTATIVE, ST PRODUCTS ARE NOT RECOMMENDED, AUTHORIZED OR WARRANTED FOR USE IN MILITARY, AIR CRAFT, SPACE, LIFE SAVING, OR LIFE SUSTAINING APPLICATIONS, NOR IN PRODUCTS OR SYSTEMS WHERE FAILURE OR MALFUNCTION MAY RESULT IN PERSONAL INJURY, DEATH, OR SEVERE PROPERTY OR ENVIRONMENTAL DAMAGE. ST PRODUCTS WHICH ARE NOT SPECIFIED AS "AUTOMOTIVE GRADE" MAY ONLY BE USED IN AUTOMOTIVE APPLICATIONS AT USER'S OWN RISK.

Resale of ST products with provisions different from the statements and/or technical features set forth in this document shall immediately void any warranty granted by ST for the ST product or service described herein and shall not create or extend in any manner whatsoever, any liability of ST.

ST and the ST logo are trademarks or registered trademarks of ST in various countries.

Information in this document supersedes and replaces all information previously supplied.

The ST logo is a registered trademark of STMicroelectronics. All other names are the property of their respective owners.

© 2010 STMicroelectronics - All rights reserved

STMicroelectronics group of companies

Australia - Belgium - Brazil - Canada - China - Czech Republic - Finland - France - Germany - Hong Kong - India - Israel - Italy - Japan - Malaysia - Malta - Morocco - Philippines - Singapore - Spain - Sweden - Switzerland - United Kingdom - United States of America

www.st.com

X-ON Electronics

Largest Supplier of Electrical and Electronic Components

Click to view similar products for [Schottky Diodes & Rectifiers](#) category:

Click to view products by [STMicroelectronics](#) manufacturer:

Other Similar products are found below :

[MA4E2039](#) [D1FH3-5063](#) [MBR0530L-TP](#) [MBR10100CT-BP](#) [MBR1545CT](#) [MMBD301M3T5G](#) [RB160M-50TR](#) [RB551V-30](#)
[BAS16E6433HTMA1](#) [BAT 54-02LRH E6327](#) [NSR05F40QNXT5G](#) [NTE555](#) [JANS1N6640](#) [SB07-03C-TB-H](#) [SB1003M3-TL-W](#) [SK310-T](#)
[SK32A-LTP](#) [SK33A-TP](#) [SK34B-TP](#) [SS3003CH-TL-E](#) [GA01SHT18](#) [CRS10I30A\(TE85L,QM](#) [MA4E2501L-1290](#) [MBRB30H30CT-1G](#)
[SB007-03C-TB-E](#) [SK32A-TP](#) [SK33B-TP](#) [SK35A-TP](#) [SK38B-TP](#) [NRVBM120LT1G](#) [NTE505](#) [NTSB30U100CT-1G](#) [SS15E-TP](#) [VS-](#)
[6CWQ10FNHM3](#) [ACDBA1100LR-HF](#) [ACDBA1200-HF](#) [ACDBA140-HF](#) [ACDBA2100-HF](#) [ACDBA3100-HF](#) [CDBQC0530L-HF](#)
[CDBQC0240LR-HF](#) [ACDBA340-HF](#) [ACDBA260LR-HF](#) [ACDBA1100-HF](#) [SK310B-TP](#) [MA4E2502L-1246](#) [MA4E2502H-1246](#)
[NRVBM120ET1G](#) [NSR01L30MXT5G](#) [NTE573](#)