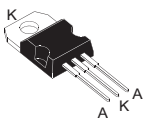
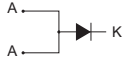
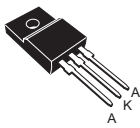

## 100 V power Schottky rectifier

**TO-220AB**

**TO-220FPAB**

### Features

- Low forward voltage drop
- Good trade-off between leakage current and forward voltage drop
- High frequency operation
- Avalanche capability specified
- ECOPACK<sup>®</sup>2 compliant

### Applications

- Switching diode
- SMPS
- DC/DC converter
- LED lighting
- Desktop power supply

### Description

This rectifier is suited for high frequency switch mode power supply.

Housed in TO-220AB and TO-220FPAB packages the [STPS30M100S](#) is optimized for use in notebook and game station adapters, providing in these applications a good efficiency at both low and high load.

#### Product status link

[STPS30M100S](#)

#### Product summary

Symbol	Value
$I_{F(AV)}$	30 A
$V_{RRM}$	100 V
$T_j$ (max.)	150 °C
$V_F$ (typ.)	0.605 V

# 1 Characteristics

**Table 1. Absolute ratings (limiting values at 25 °C, unless otherwise specified, anode terminals short circuited)**

Symbol	Parameter	Value	Unit
V <sub>RRM</sub>	Repetitive peak reverse voltage	100	V
I <sub>F(RMS)</sub>	Forward rms current	60	A
I <sub>F(AV)</sub>	Average forward current	30	A
I <sub>FSM</sub>	Surge non repetitive forward current	t <sub>p</sub> = 10 ms sinusoidal	300 A
P <sub>ARM</sub>	Repetitive peak avalanche power	t <sub>p</sub> = 10 μs, T <sub>j</sub> = 125 °C	1900 W
T <sub>stg</sub>	Storage temperature range	-65 to +175	°C
T <sub>j</sub>	Maximum operating junction temperature <sup>(1)</sup>	150	°C

1.  $(dP_{tot}/dT_j) < (1/R_{th(j-a)})$  condition to avoid thermal runaway for a diode on its own heatsink.

**Table 2. Thermal resistance parameters**

Symbol	Parameter	Max. value	Unit
R <sub>th(j-c)</sub>	Junction to case	TO-220AB	1
		TO-220FPAB	4

**Table 3. Static electrical characteristics (anode terminals short circuited)**

Symbol	Parameter	Test conditions	Min.	Typ.	Max.	Unit	
I <sub>R</sub> <sup>(1)</sup>	Reverse leakage current	T <sub>j</sub> = 25 °C	V <sub>R</sub> = V <sub>RRM</sub>	-		175	μA
		T <sub>j</sub> = 125 °C		-	20	50	mA
		T <sub>j</sub> = 25 °C	V <sub>R</sub> = 70 V	-		60	μA
		T <sub>j</sub> = 125 °C		-	10	20	mA
V <sub>F</sub> <sup>(2)</sup>	Forward voltage drop	T <sub>j</sub> = 25 °C	I <sub>F</sub> = 5 A	-	0.475		V
		T <sub>j</sub> = 125 °C		-	0.385		
		T <sub>j</sub> = 25 °C	I <sub>F</sub> = 10 A	-	0.555		
		T <sub>j</sub> = 125 °C		-	0.475		
		T <sub>j</sub> = 25 °C	I <sub>F</sub> = 15 A	-	0.620	0.660	
		T <sub>j</sub> = 125 °C		-	0.525	0.565	
		T <sub>j</sub> = 25 °C	I <sub>F</sub> = 30 A	-	0.740	0.800	
		T <sub>j</sub> = 125 °C		-	0.605	0.655	

1. Pulse test: t<sub>p</sub> = 5 ms, δ < 2%

2. Pulse test: t<sub>p</sub> = 380 μs, δ < 2%

To evaluate the conduction losses, use the following equation:

$$P = 0.475 \times I_{F(AV)} + 0.006 \times I_{F(RMS)}^2$$

For more information, please refer to the following application notes related to the power losses :

- AN604: Calculation of conduction losses in a power rectifier
- AN4021: Calculation of reverse losses on a power diode

## 1.1 Characteristics (curves)

**Figure 1. Average forward power dissipation versus average forward current**

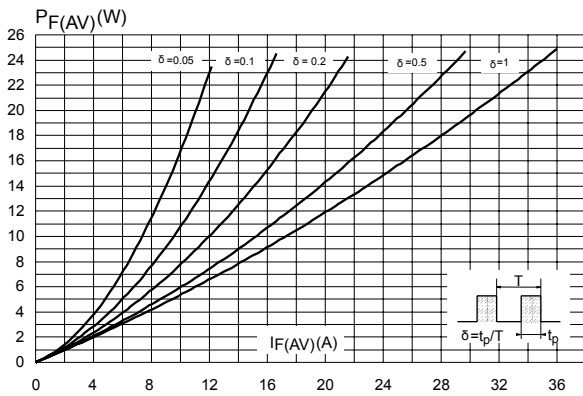

**Figure 2. Average forward current versus ambient temperature ( $\delta = 0.5$ , TO-220AB)**

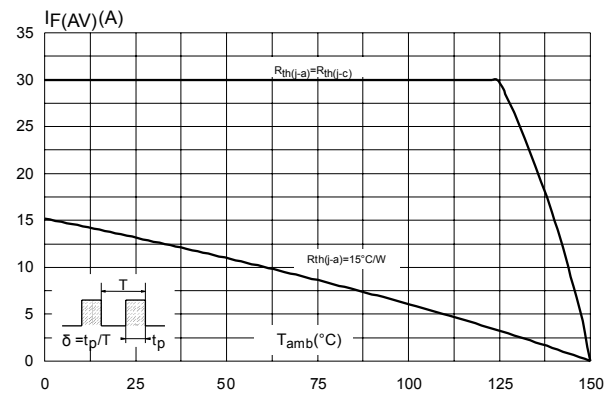

**Figure 3. Normalized avalanche power derating versus pulse duration ( $T_j = 125^\circ\text{C}$ )**

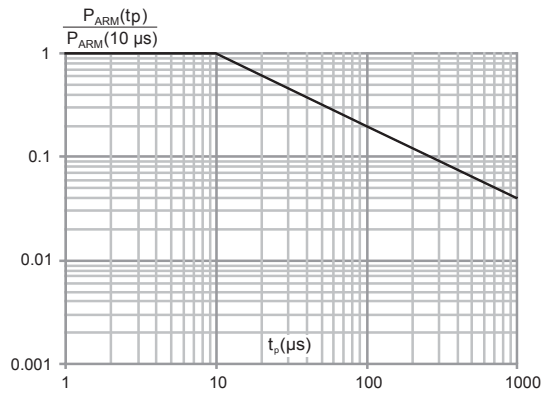

**Figure 4. Relative variation of thermal impedance junction to case versus pulse duration (TO-220AB)**

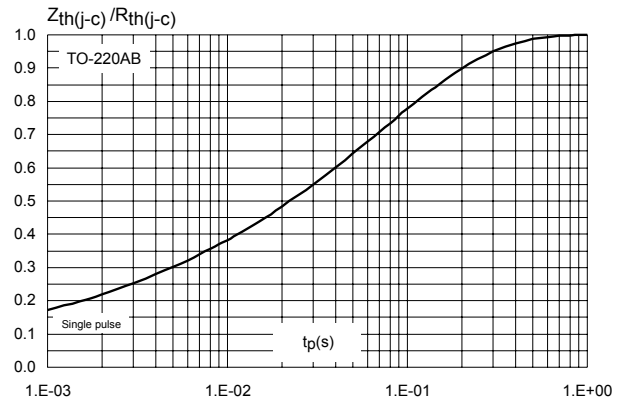

**Figure 5. Relative variation of thermal impedance junction to case versus pulse duration (TO-220FPAB)**

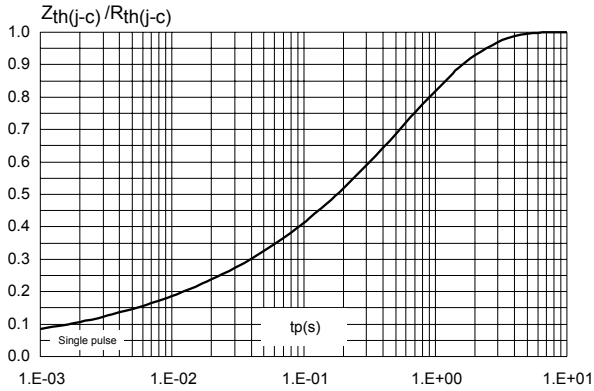

**Figure 6. Reverse leakage current versus reverse voltage applied (typical values)**

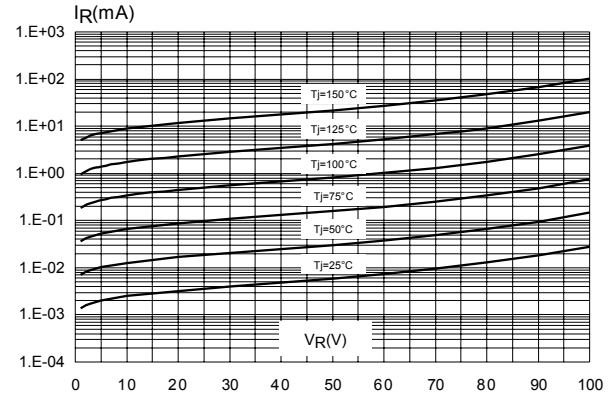

**Figure 7. Junction capacitance versus reverse voltage applied (typical values)**

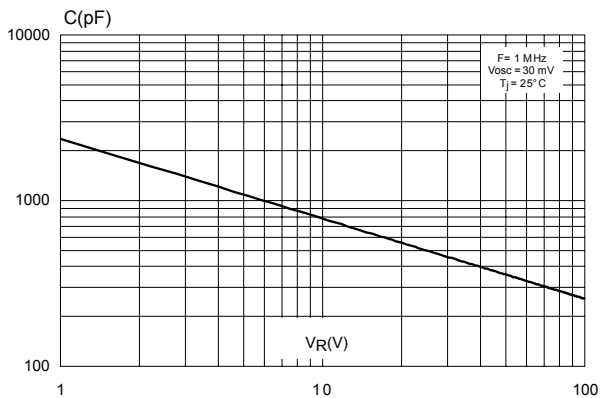

**Figure 8. Forward voltage drop versus forward current (high level)**

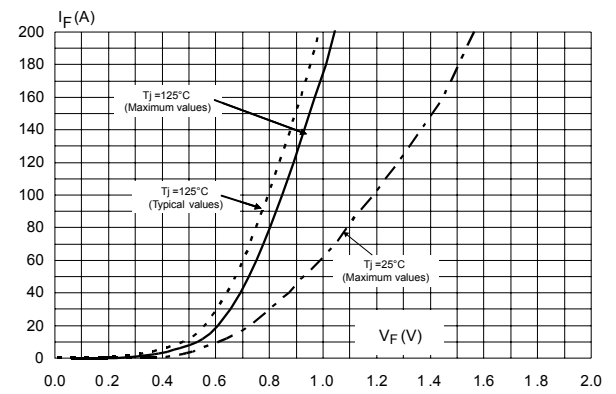

**Figure 9. Forward voltage drop versus forward current (low level)**

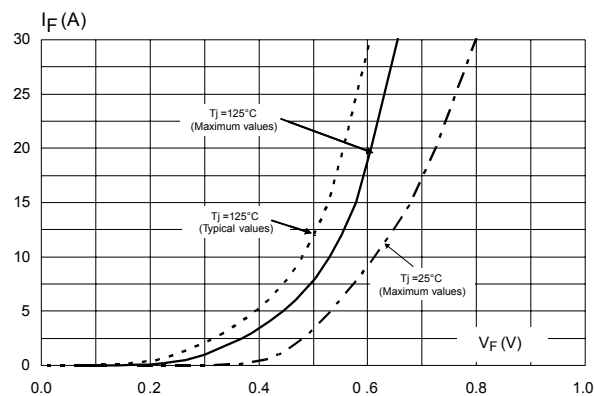

## 2 Package information

In order to meet environmental requirements, ST offers these devices in different grades of ECOPACK® packages, depending on their level of environmental compliance. ECOPACK® specifications, grade definitions and product status are available at: [www.st.com](http://www.st.com). ECOPACK® is an ST trademark.

### 2.1 TO-220AB package information

- Epoxy meets UL 94,V0
- Cooling method: by conduction (C)
- Recommended torque value: 0.55 N·m
- Maximum torque value: 0.70 N·m

Figure 10. TO-220AB package outline

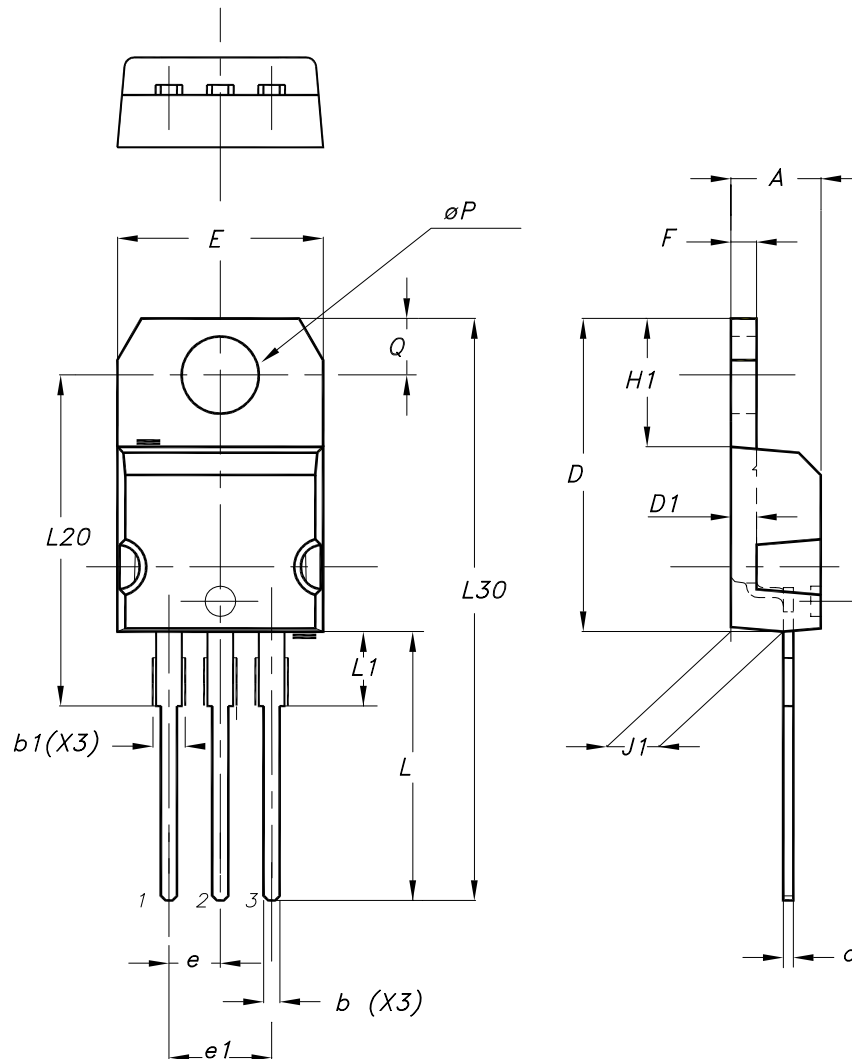

**Table 4. TO-220AB package mechanical data**

Ref.	Dimensions			
	Millimeters		Inches (for reference only)	
	Min.	Max.	Min.	Max.
A	4.40	4.60	0.173	0.181
b	0.61	0.88	0.240	0.035
b1	1.14	1.55	0.045	0.061
c	0.48	0.70	0.019	0.028
D	15.25	15.75	0.600	0.620
D1	1.27 typ.		0.050 typ.	
E	10.00	10.40	0.394	0.409
e	2.40	2.70	0.094	0.106
e1	4.95	5.15	0.195	0.203
F	1.23	1.32	0.048	0.052
H1	6.20	6.60	0.244	0.260
J1	2.40	2.72	0.094	0.107
L	13.00	14.00	0.512	0.551
L1	3.50	3.93	0.138	0.155
L20	16.40 typ.		0.646 typ.	
L30	28.90 typ.		1.138 typ.	
θP	3.75	3.85	0.148	0.152
Q	2.65	2.95	0.104	0.116

## 2.2 TO-220FPAB package information

- Epoxy meets UL94, V0
- Cooling method: by conduction (C)
- Recommended torque value: 0.55 N·m
- Maximum torque value: 0.70 N·m

Figure 11. TO-220FPAB package outline

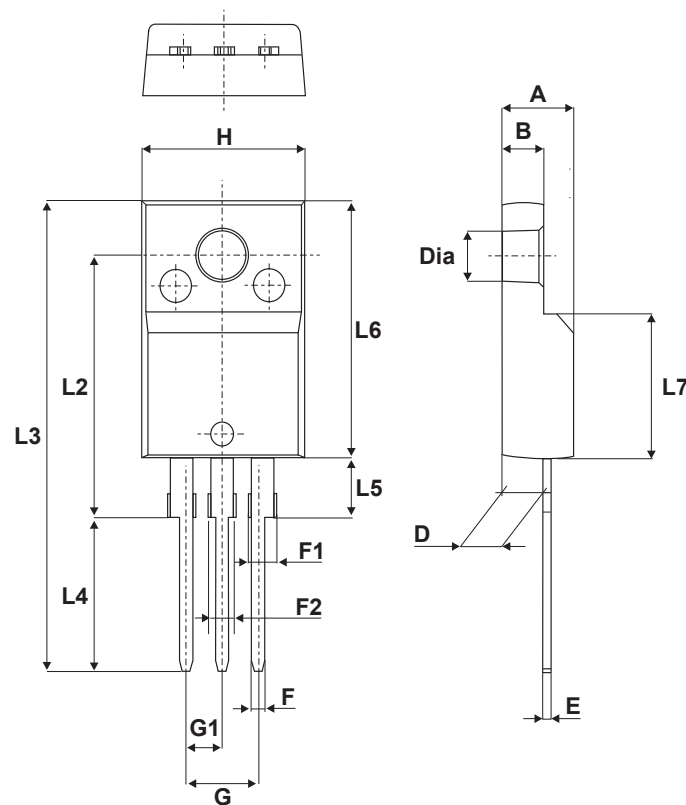

Table 5. TO-220FPAB package mechanical data

Ref.	Dimensions			
	Millimeters		Inches (for reference only)	
	Min.	Max.	Min.	Max.
A	4.40	4.60	0.173	0.181
B	2.50	2.70	0.098	0.106
D	2.50	2.75	0.098	0.108
E	0.45	0.70	0.018	0.027
F	0.75	1.00	0.03	0.039

Ref.	Dimensions			
	Millimeters		Inches (for reference only)	
	Min.	Max.	Min.	Max.
F1	1.15	1.70	0.045	0.067
F2	1.15	1.70	0.045	0.067
G	4.95	5.20	0.195	0.205
G1	2.40	2.70	0.094	0.106
H	10.00	10.40	0.393	0.409
L2	16.00 typ.		0.63 typ.	
L3	28.60	30.60	1.126	1.205
L4	9.80	10.60	0.386	0.417
L5	2.90	3.60	0.114	0.142
L6	15.90	16.40	0.626	0.646
L7	9.00	9.30	0.354	0.366
Dia	3.00	3.20	0.118	0.126



### 3 Ordering information

**Table 6. Ordering information**

Order code	Marking	Package	Weight	Base qty.	Delivery mode
STPS30M100ST	STPS30M100ST	TO-220AB	1.95 g	50	Tube
STPS30M100SFP	STPS30M100SFP	TO-220FPAB	1.9 g	50	Tube

## Revision history

**Table 7. Document revision history**

Date	Version	Changes
25-Mar-2009	1	First issue.
15-Apr-2010	2	Updated package graphic on front page. Updated Table 3, Table 5, Table 6, and Table 7.
28-Jan-2011	3	Added warning paragraph above Table 7.
28-Jun-2018	4	<p>Removed I<sup>2</sup>PAK package, figure 5, figure 6, figure 8 and figure 14.</p> <p>Updated Table 1. Absolute ratings (limiting values at 25 °C, unless otherwise specified, anode terminals short circuited) and Figure 3. Normalized avalanche power derating versus pulse duration (T<sub>j</sub> = 125 °C).</p> <p>Minor text changes to improve readability.</p>

**IMPORTANT NOTICE – PLEASE READ CAREFULLY**

STMicroelectronics NV and its subsidiaries (“ST”) reserve the right to make changes, corrections, enhancements, modifications, and improvements to ST products and/or to this document at any time without notice. Purchasers should obtain the latest relevant information on ST products before placing orders. ST products are sold pursuant to ST’s terms and conditions of sale in place at the time of order acknowledgement.

Purchasers are solely responsible for the choice, selection, and use of ST products and ST assumes no liability for application assistance or the design of Purchasers’ products.

No license, express or implied, to any intellectual property right is granted by ST herein.

Resale of ST products with provisions different from the information set forth herein shall void any warranty granted by ST for such product.

ST and the ST logo are trademarks of ST. All other product or service names are the property of their respective owners.

Information in this document supersedes and replaces information previously supplied in any prior versions of this document.

© 2018 STMicroelectronics – All rights reserved

## X-ON Electronics

Largest Supplier of Electrical and Electronic Components

*Click to view similar products for [Schottky Diodes & Rectifiers](#) category:*

*Click to view products by [STMicroelectronics](#) manufacturer:*

Other Similar products are found below :

[MA4E2039](#) [D1FH3-5063](#) [MBR0530L-TP](#) [MBR10100CT-BP](#) [MBR1545CT](#) [MMBD301M3T5G](#) [RB160M-50TR](#) [RB551V-30](#)  
[BAS16E6433HTMA1](#) [BAT 54-02LRH E6327](#) [NSR05F40QNXT5G](#) [NTE555](#) [JANS1N6640](#) [SB07-03C-TB-H](#) [SB1003M3-TL-W](#) [SK310-T](#)  
[SK32A-LTP](#) [SK33A-TP](#) [SK34B-TP](#) [SS3003CH-TL-E](#) [GA01SHT18](#) [CRS10I30A\(TE85L,QM](#) [MA4E2501L-1290](#) [MBRB30H30CT-1G](#)  
[SB007-03C-TB-E](#) [SK32A-TP](#) [SK33B-TP](#) [SK35A-TP](#) [SK38B-TP](#) [NRVBM120LT1G](#) [NTE505](#) [NTSB30U100CT-1G](#) [SS15E-TP](#) [VS-](#)  
[6CWQ10FNHM3](#) [ACDBA1100LR-HF](#) [ACDBA1200-HF](#) [ACDBA140-HF](#) [ACDBA2100-HF](#) [ACDBA3100-HF](#) [CDBQC0530L-HF](#)  
[CDBQC0240LR-HF](#) [ACDBA340-HF](#) [ACDBA260LR-HF](#) [ACDBA1100-HF](#) [SK310B-TP](#) [MA4E2502L-1246](#) [MA4E2502H-1246](#)  
[NRVBM120ET1G](#) [NSR01L30MXT5G](#) [NTE573](#)