

## 40 V, 3 A power Schottky rectifier

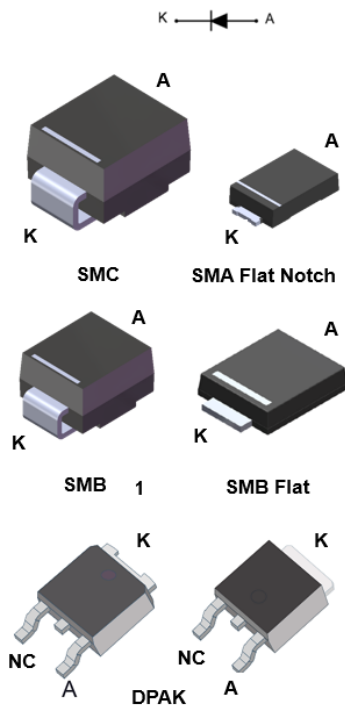

### Features

- Very small conduction losses
- Negligible switching losses
- Low forward voltage drop
- Low thermal resistance
- Extremely fast switching
- Surface mount package
- Avalanche rated
- **ECOPACK2** component

### Applications

- Telecom power supply
- Set-top box power supply
- TV power supply
- Battery charger

### Description

Single chip Schottky rectifier suited for switch mode power supplies and high frequency DC to DC converters.

Packaged in SMA Flat Notch, SMB, SMB Flat, SMC and DPAK, the **STPS340** is ideal for surface mounting and used in low voltage, high frequency inverters, free wheeling and polarity protection applications.

Product status	
STPS340	
Product summary	
Symbol	Value
$I_{F(AV)}$	3 A
$V_{RRM}$	40 V
$T_{j(max.)}$	150 °C
$V_{F(typ.)}$	0.52 V

# 1 Characteristics

**Table 1. Absolute ratings (limiting values at 25 °C, unless otherwise specified)**

Symbol	Parameter	Value	Unit		
$V_{RRM}$	Repetitive peak reverse voltage	40	V		
$I_{F(RMS)}$	Forward rms current	6	A		
$I_{F(AV)}$	Average forward current, $\delta = 0.5$ , square wave	SMA Flat Notch	$T_L = 105\text{ °C}$	3	A
		SMB	$T_L = 95\text{ °C}$		
		SMB Flat	$T_L = 115\text{ °C}$		
		SMC	$T_L = 105\text{ °C}$		
		DPAK	$T_C = 135\text{ °C}$		
$I_{FSM}$	Surge non repetitive forward current	SMA Flat Notch	$t_p = 10\text{ ms sinusoidal}$	105	A
		All others		75	A
$P_{ARM}$	Repetitive peak avalanche power	$t_p = 10\text{ }\mu\text{s}, T_j = 125\text{ °C}$	90	W	
$T_{stg}$	Storage temperature range	-65 to +150	°C		
$T_j$	Maximum operating junction temperature <sup>(1)</sup>	+150	°C		

1.  $(dP_{tot}/dT_j) < (1/R_{th(j-a)})$  condition to avoid thermal runaway for a diode on its own heatsink.

**Table 2. Thermal resistance parameter**

Symbol	Parameter	Max. value	Unit	
$R_{th(j-l)}$	Junction to lead	SMA Flat Notch	20	°C/W
		SMB	25	
		SMB Flat	15	
		SMC	20	
$R_{th(j-c)}$	Junction to case	DPAK	5.5	

For more information, please refer to the following application note :

- AN5088 : Rectifiers thermal management, handling and mounting recommendations

**Table 3. Static electrical characteristics**

Symbol	Parameter	Test conditions	Min.	Typ.	Max.	Unit	
$I_R^{(1)}$	Reverse leakage current	$T_j = 25\text{ °C}$	$V_R = V_{RRM}$	-		20	$\mu\text{A}$
		$T_j = 125\text{ °C}$		-	2	10	mA
$V_F^{(1)}$	Forward voltage drop	$T_j = 25\text{ °C}$	$I_F = 3\text{ A}$	-		0.63	V
		$T_j = 125\text{ °C}$		-	0.52	0.57	
		$T_j = 25\text{ °C}$	$I_F = 6\text{ A}$	-		0.84	
		$T_j = 125\text{ °C}$		-	0.63	0.72	

1. Pulse test:  $t_p = 380\text{ }\mu\text{s}$ ,  $\delta < 2\%$

To evaluate the conduction losses, use the following equation:

$$P = 0.42 \times I_{F(AV)} + 0.050 \times I_{F(RMS)}^2$$

For more information, please refer to the following application notes related to the power losses :

- AN604: Calculation of conduction losses in a power rectifier
- AN4021: Calculation of reverse losses on a power diode

### 1.1 Characteristics (curves)

**Figure 1. Average forward power dissipation versus average forward current**

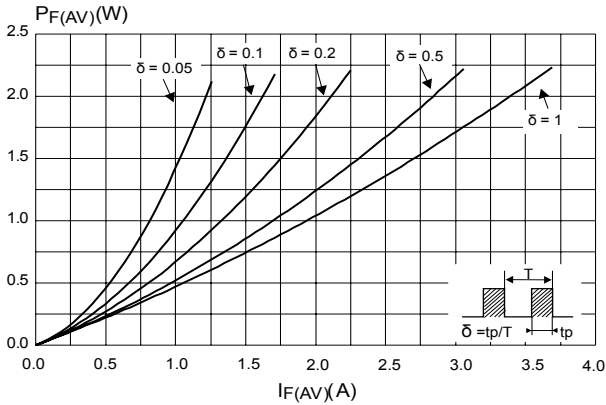

**Figure 2. Average forward current versus ambient temperature ( $\delta = 0.5$ ) (SMB, SMC, DPAK)**

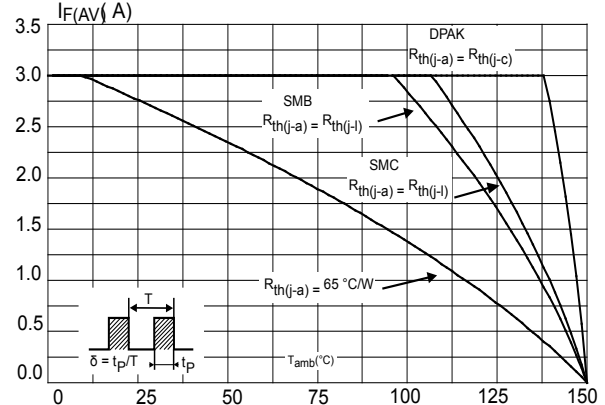

**Figure 3. Average forward current versus ambient temperature ( $\delta = 0.5$ , SMB Flat)**

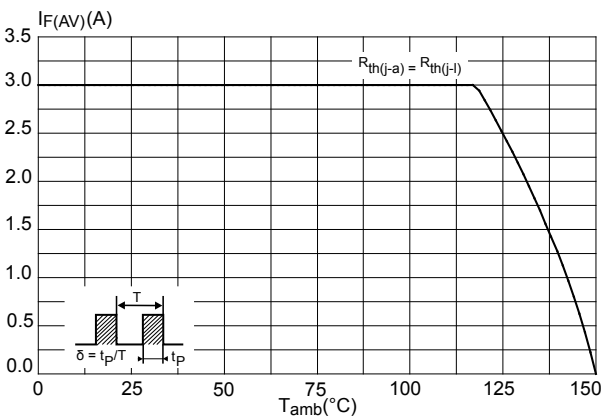

**Figure 4. Normalized avalanche power derating versus pulse duration ( $T_j = 125\text{ °C}$ )**

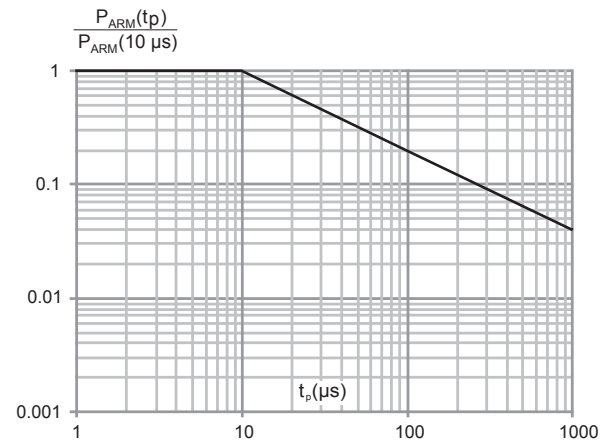

**Figure 5. Relative variation of thermal impedance junction to ambient versus pulse duration (SMB)**

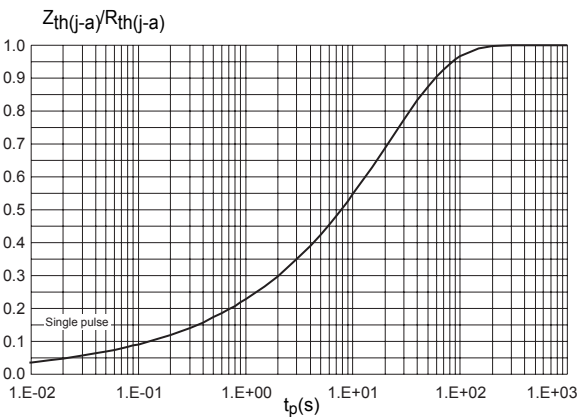

**Figure 6. Relative variation of thermal impedance junction to lead versus pulse duration (SMB flat)**

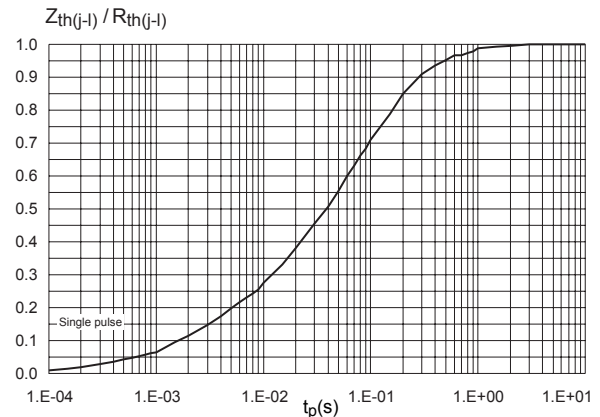

**Figure 7. Relative variation of thermal impedance junction to ambient versus pulse duration (SMC)**

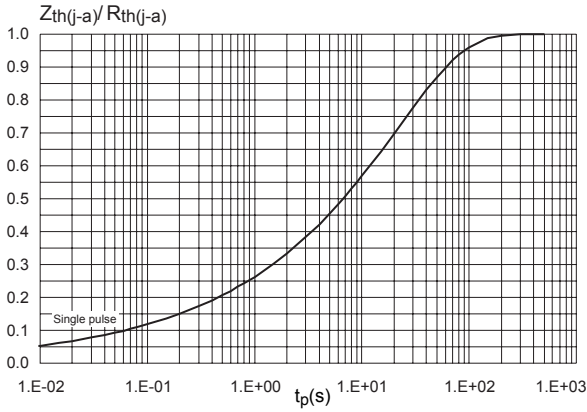

**Figure 8. Relative variation of thermal impedance junction to case versus pulse duration (DPAK)**

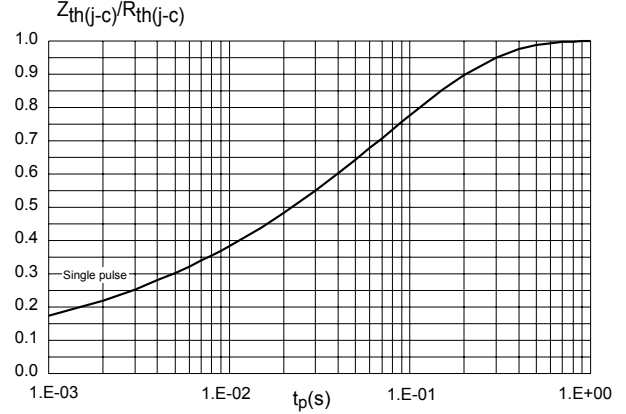

**Figure 9. Reverse leakage current versus reverse voltage applied (typical values)**

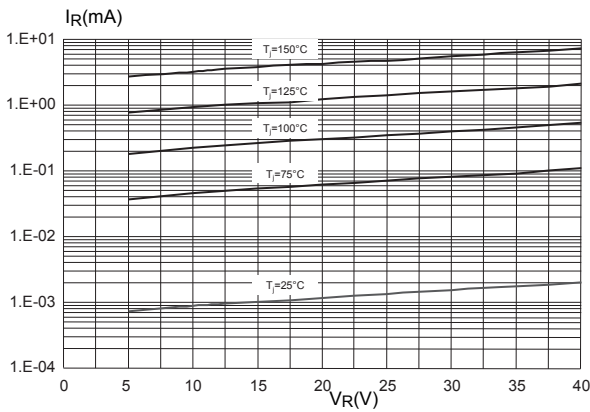

**Figure 10. Junction capacitance versus reverse voltage applied (typical values)**

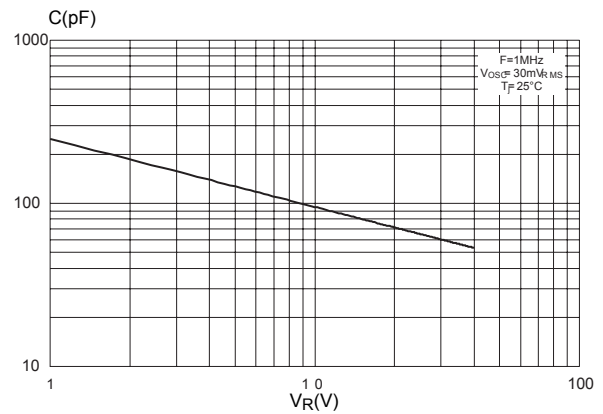

**Figure 11. Forward voltage drop versus forward current**

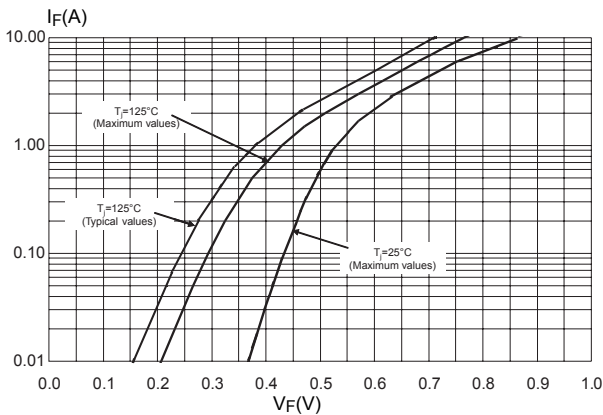

**Figure 12. Thermal resistance junction to ambient versus copper surface under each lead (SMA Flat Notch)**

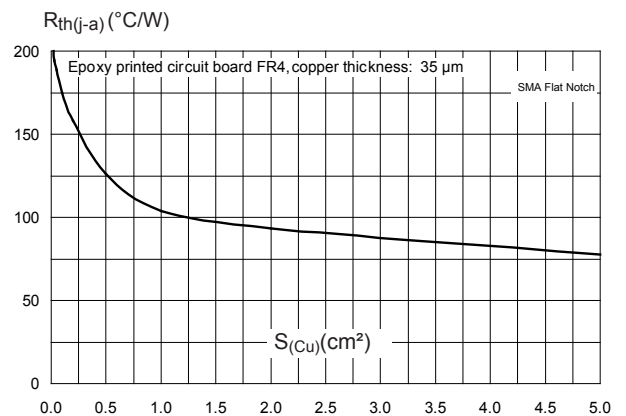

**Figure 13. Thermal resistance junction to ambient versus copper surface under each lead (SMB)**

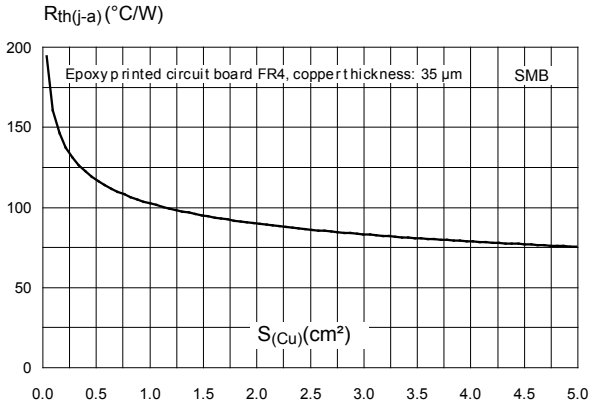

**Figure 14. Thermal resistance junction to ambient versus copper surface under each lead (SMB flat)**

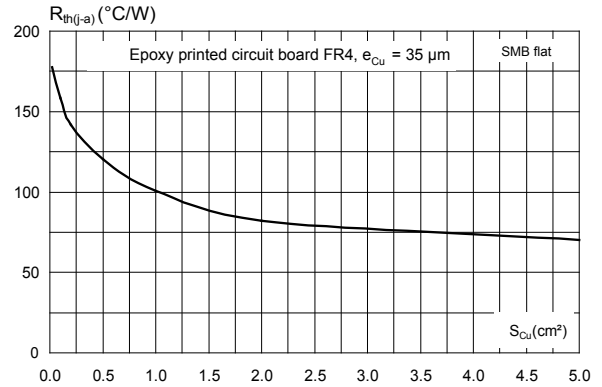

**Figure 15. Thermal resistance junction to ambient versus copper surface under each lead (SMC)**

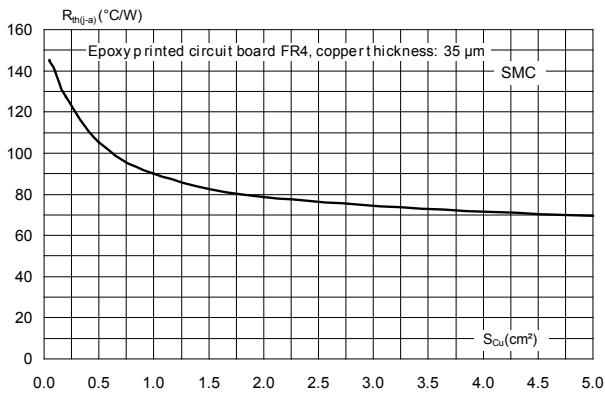

**Figure 16. Thermal resistance junction to ambient versus copper surface under tab (DPAK)**

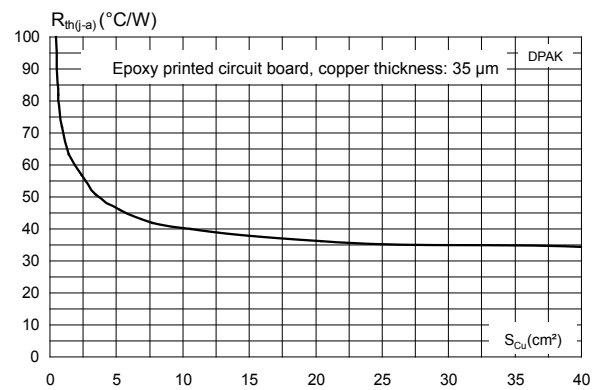

## 2 Package information

In order to meet environmental requirements, ST offers these devices in different grades of **ECOPACK** packages, depending on their level of environmental compliance. ECOPACK specifications, grade definitions and product status are available at: [www.st.com](http://www.st.com). ECOPACK is an ST trademark.

### 2.1 SMA Flat Notch package information

- Epoxy meets UL94, V0
- Cooling method: by conduction (C)
- Band indicates cathode

Figure 17. SMA Flat Notch package outline

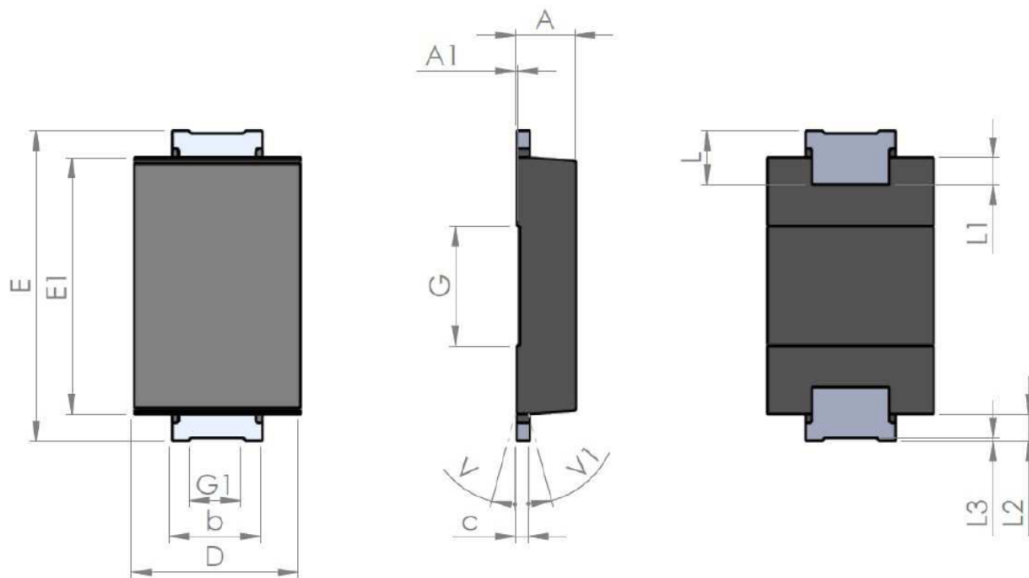

**Table 4. SMA Flat Notch package mechanical data**

Ref.	Dimensions					
	Millimeters			Inches (for reference only)		
	Min.	Typ.	Max.	Min.	Typ.	Max.
A1	0.90		1.10	0.035		0.044
A1		0.05			0.002	
b	1.25		1.65	0.049		0.065
C	0.15		0.40	0.005		0.016
D	2.25		2.90	0.088		0.115
E	5.00		5.35	0.196		0.211
E1	3.95		4.60	0.155		0.182
G		2.00			0.079	
G1		0.85			0.033	
L	0.75		1.20	0.029		
L1		0.45			0.018	
L2		0.45			0.018	
L3		0.05			0.002	
V			8°			8°
V1			8°			8°

**Figure 18. SMA Flat Notch recommended footprint in mm (inches)**

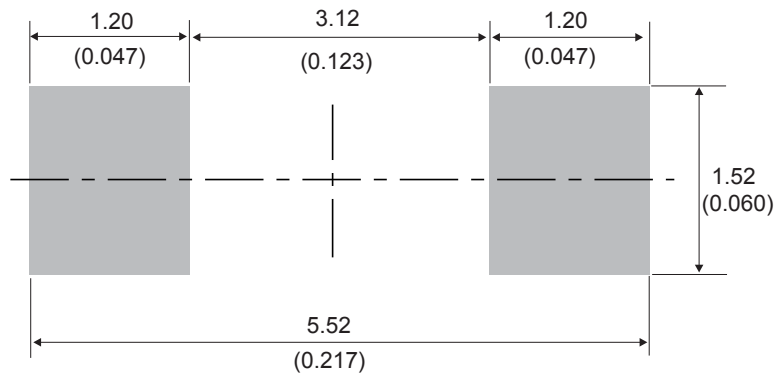



## 2.2 SMB package information

- Epoxy meets UL94, V0
- Lead-free package

Figure 19. SMB package outline

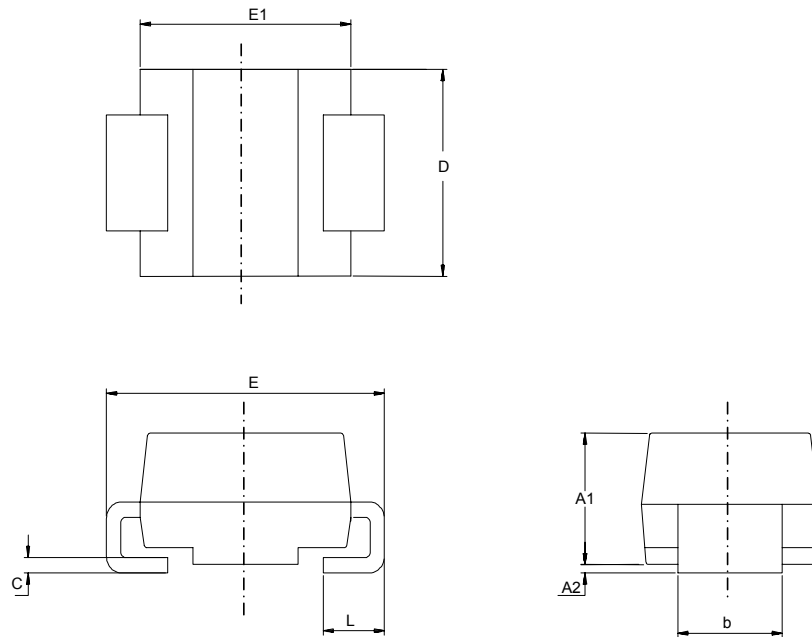
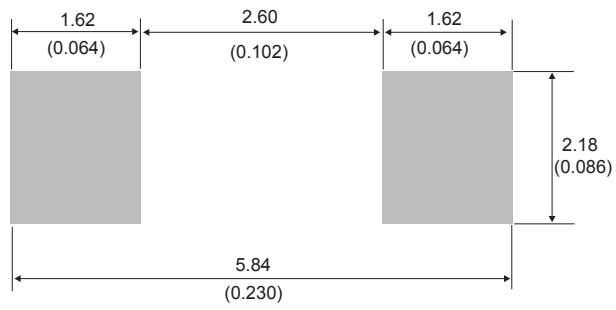

Table 5. SMB package mechanical data

Ref.	Dimensions			
	Millimeters		Inches (for reference only)	
	Min.	Max.	Min.	Max.
A1	1.90	2.45	0.074	0.097
A2	0.05	0.20	0.001	0.008
b	1.95	2.20	0.076	0.087
c	0.15	0.40	0.005	0.016
D	3.30	3.95	0.129	0.156
E	5.10	5.60	0.200	0.221
E1	4.05	4.60	0.159	0.182
L	0.75	1.50	0.029	0.060

Figure 20. SMB recommended footprint



## 2.3 SMB Flat package information

- Epoxy meets UL94, V0
- Lead-free package

Figure 21. SMB Flat package outline

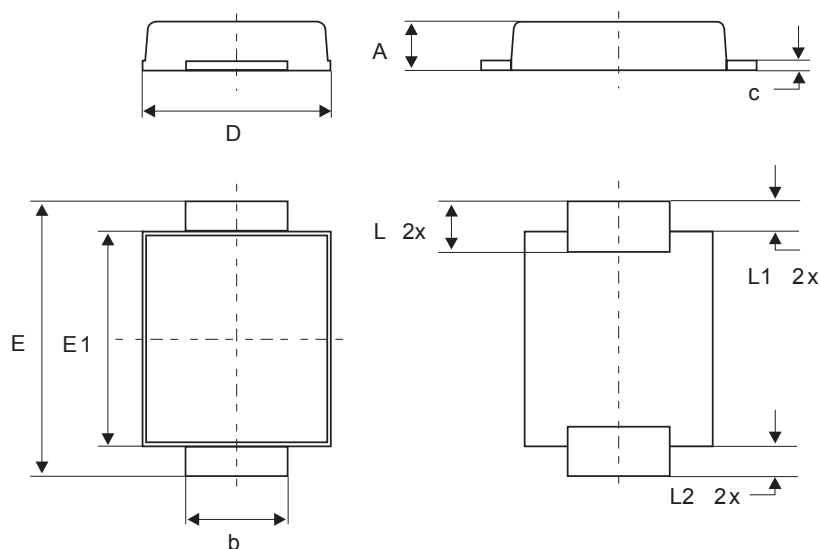
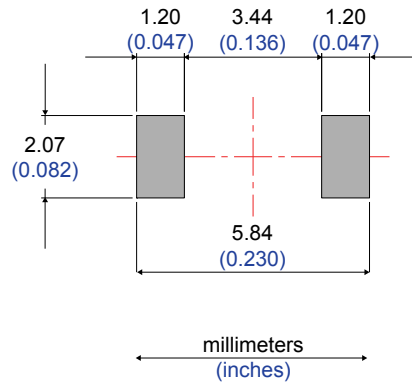

Table 6. SMB Flat mechanical data

Ref.	Dimensions					
	Millimeters			Inches		
	Min.	Typ.	Max.	Min.	Typ.	Max.
A	0.90		1.10	0.035		0.044
b	1.95		2.20	0.076		0.087
c	0.15		0.40	0.005		0.016
D	3.30		3.95	0.129		0.156
E	5.10		5.60	0.200		0.221
E1	4.05		4.60	0.159		0.182
L	0.75		1.50	0.029		0.060
L1		0.40			0.016	
L2		0.60			0.024	

Figure 22. Footprint recommendations, dimensions in mm (inches)



## 2.4 SMC package information

- Epoxy meets UL94, V0

Figure 23. SMC package outline

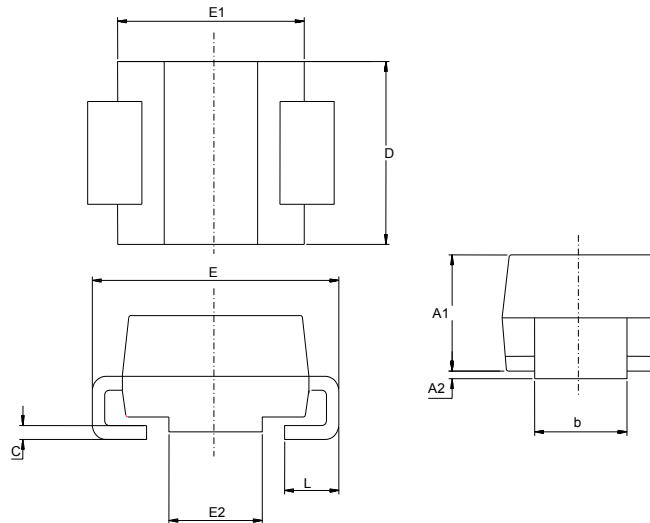
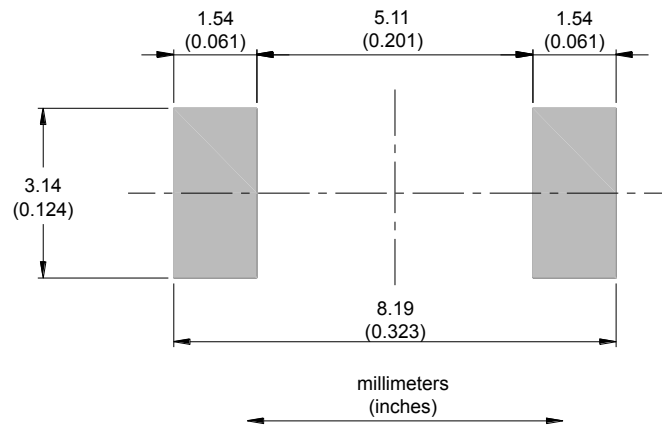

Table 7. SMC package mechanical data

Ref.	Dimensions			
	Millimeters		Inches (for reference only)	
	Min.	Max.	Min.	Max.
A1	1.90	2.45	0.0748	0.0965
A2	0.05	0.20	0.0020	0.0079
b	2.90	3.20	0.1142	0.1260
c	0.15	0.40	0.0059	0.0157
D	5.55	6.25	0.2185	0.2461
E	7.75	8.15	0.3051	0.3209
E1	6.60	7.15	0.2598	0.2815
E2	4.40	4.70	0.1732	0.1850
L	0.75	1.50	0.0295	0.0591

Figure 24. SMC recommended footprint



## 2.5 DPAK package information

- Epoxy meets UL 94,V0
- Cooling method: by conduction (C)

Figure 25. DPAK package outline

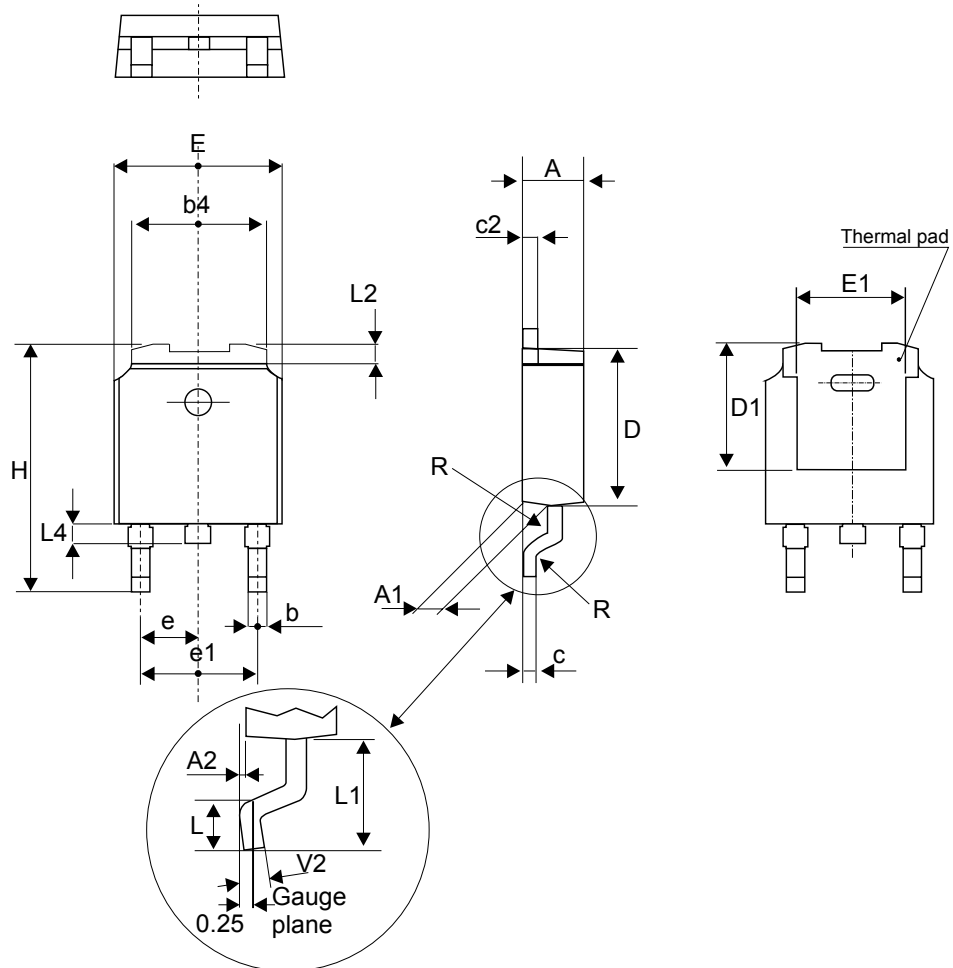

**Note:** This package drawing may slightly differ from the physical package. However, all the specified dimensions are guaranteed.

Table 8. DPAK package mechanical data

Ref.	Dimensions			
	Millimeters		Inches (for reference only)	
	Min.	Max.	Min.	Max.
A	2.18	2.40	0.085	0.094
A1	0.90	1.10	0.035	0.043
A2	0.03	0.23	0.001	0.009
b	0.64	0.90	0.025	0.035
b4	4.95	5.46	0.194	0.215
c	0.46	0.61	0.018	0.024
c2	0.46	0.60	0.018	0.023
D	5.97	6.22	0.235	0.244
D1	4.95	5.60	0.194	0.220
E	6.35	6.73	0.250	0.265
E1	4.32	5.50	0.170	0.216
e	2.286 typ.		0.090 typ.	
e1	4.40	4.70	0.173	0.185
H	9.35	10.40	0.368	0.409
L	1.0	1.78	0.039	0.070
L2		1.27		0.050
L4	0.60	1.02	0.023	0.040
V2	-8°	+8°	-8°	+8°

Figure 26. DPAK recommended footprint (dimensions in mm)

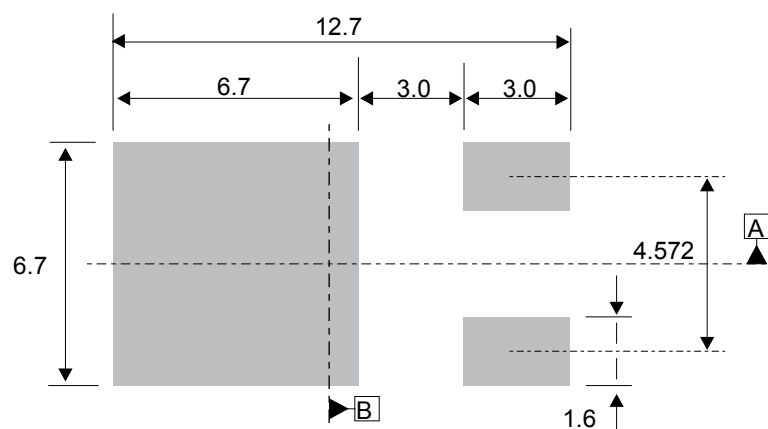

The device must be positioned within  $\oplus 0.05 \text{ AB}$



### 3 Ordering information

**Table 9. Ordering information**

Order code	Marking	Package	Weight	Base qty.	Delivery mode
STPS340AFN	A340	SMA Flat Notch	0.039 g	10 000	Tape and reel
STPS340U	U34	SMB	0.107 g	2500	Tape and reel
STPS340UF	FU34	SMB Flat	0.050 g	5000	Tape and reel
STPS340S	S34	SMC	0.243 g	10 000	Tape and reel
STPS340B-TR	S3 40	DPAK	0.320 g	2500	Tape and reel

## Revision history

**Table 10. Document revision history**

Date	Version	Changes
Jul-2003	7	Last update.
Feb-2005	8	Layout update. No content change.
08-Feb-2007	9	Reformatted to current standard. Added ECOPACK statement. Added SMBflat package.
10-Feb-2009	10	Updated ECOPACK statement. Corrected Y axis in Figure 10.
23-Apr-2015	11	Updated DPAK and reformatted to current standard.
22-Sep-2016	12	Updated DPAK package information and reformatted to current standard.
08-Oct-2019	13	Added <a href="#">Section 2.1 SMA Flat Notch package information</a> .

**IMPORTANT NOTICE – PLEASE READ CAREFULLY**

STMicroelectronics NV and its subsidiaries (“ST”) reserve the right to make changes, corrections, enhancements, modifications, and improvements to ST products and/or to this document at any time without notice. Purchasers should obtain the latest relevant information on ST products before placing orders. ST products are sold pursuant to ST’s terms and conditions of sale in place at the time of order acknowledgement.

Purchasers are solely responsible for the choice, selection, and use of ST products and ST assumes no liability for application assistance or the design of Purchasers’ products.

No license, express or implied, to any intellectual property right is granted by ST herein.

Resale of ST products with provisions different from the information set forth herein shall void any warranty granted by ST for such product.

ST and the ST logo are trademarks of ST. For additional information about ST trademarks, please refer to [www.st.com/trademarks](http://www.st.com/trademarks). All other product or service names are the property of their respective owners.

Information in this document supersedes and replaces information previously supplied in any prior versions of this document.

© 2019 STMicroelectronics – All rights reserved

## X-ON Electronics

Largest Supplier of Electrical and Electronic Components

*Click to view similar products for [Schottky Diodes & Rectifiers](#) category:*

*Click to view products by [STMicroelectronics](#) manufacturer:*

Other Similar products are found below :

[MA4E2039](#) [D1FH3-5063](#) [MBR10100CT-BP](#) [MBR1545CT](#) [MMBD301M3T5G](#) [RB160M-50TR](#) [RB551V-30](#) [BAS16E6433HTMA1](#) [BAT](#)  
[54-02LRH E6327](#) [NSR05F40QNXT5G](#) [NTE555](#) [JANS1N6640](#) [SB07-03C-TB-H](#) [SB1003M3-TL-W](#) [SK310-T](#) [SK32A-LTP](#) [SK33A-TP](#)  
[SK34B-TP](#) [SS3003CH-TL-E](#) [GA01SHT18](#) [CRS10I30A\(TE85L,QM](#) [MA4E2501L-1290](#) [MBRB30H30CT-1G](#) [SB007-03C-TB-E](#) [SK32A-TP](#)  
[SK33B-TP](#) [SK35A-TP](#) [SK38B-TP](#) [NRVBM120LT1G](#) [NTE505](#) [NTSB30U100CT-1G](#) [SS15E-TP](#) [VS-6CWQ10FNHM3](#) [ACDBA1100LR-HF](#)  
[ACDBA1200-HF](#) [ACDBA140-HF](#) [ACDBA2100-HF](#) [ACDBA3100-HF](#) [CDBQC0530L-HF](#) [CDBQC0240LR-HF](#) [ACDBA340-HF](#)  
[ACDBA260LR-HF](#) [ACDBA1100-HF](#) [SK310B-TP](#) [MA4E2502L-1246](#) [MA4E2502H-1246](#) [NRVBM120ET1G](#) [NSR01L30MXT5G](#) [NTE573](#)  
[NTE6081](#)