

1200 V power Schottky silicon carbide diode

Datasheet - production data

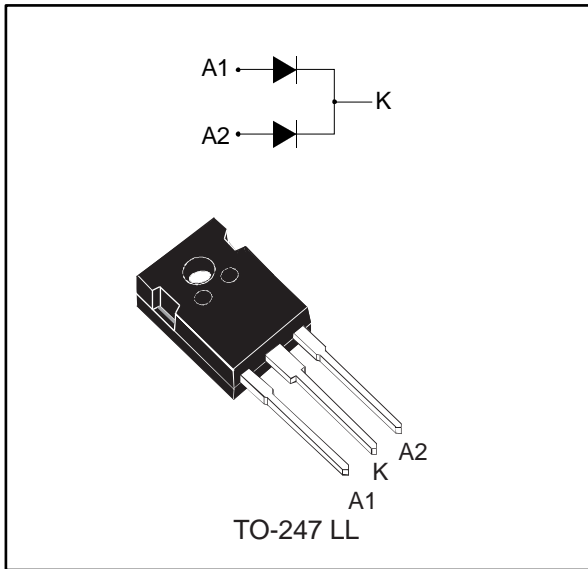

Description

The SiC diode, available in TO-247 LL, is an ultrahigh performance power Schottky rectifier. It is manufactured using a silicon carbide substrate. The wide band-gap material allows the design of a low V_F Schottky diode structure with a 1200 V rating. Due to the Schottky construction, no recovery is shown at turn-off and ringing patterns are negligible. The minimal capacitive turn-off behavior is independent of temperature.

Especially suited for use in PFC and secondary side applications, this ST SiC diode will boost the performance in hard switching conditions. This rectifier will enhance the performance of the targeted application. Its high forward surge capability ensures a good robustness during transient phases.

Features

- No or negligible reverse recovery
- Switching behavior independent of temperature
- Robust high voltage periphery
- Operating T_j from $-40\text{ }^\circ\text{C}$ to $175\text{ }^\circ\text{C}$
- ECOPACK[®]2 compliant

Table 1: Device summary

| Symbol | Value |
|--------------|----------|
| $I_{F(AV)}$ | 2 x 20 A |
| V_{RRM} | 1200 V |
| T_j (max.) | 175 °C |
| V_F (typ.) | 1.35 V |

1 Characteristics

Table 2: Absolute ratings (limiting values per diode at 25 °C, unless otherwise specified)

| Symbol | Parameter | | Value | Unit | |
|---------------------|--|---|-------------------------|-------|---|
| V _{RRM} | Repetitive peak reverse voltage (T _j = -40 °C to +175 °C) | | 1200 | V | |
| I _{F(RMS)} | Forward rms current | | 38 | A | |
| I _{F(AV)} | Average forward current | T _C = 150 °C, DC current | Per diode/per device | 20/40 | A |
| | | T _C = 135 °C, DC current | | 27/54 | |
| | | T _C = 25 °C, DC current | | 38/76 | |
| I _{FRM} | Repetitive peak forward current | T _C = 150 °C, T _j = 175 °C, δ = 0.1 | 79 | A | |
| I _{FSM} | Surge non repetitive forward current | t _p = 10 ms sinusoidal | T _C = 25 °C | 140 | A |
| | | | T _C = 150 °C | 120 | |
| | | t _p = 10 μs square | T _C = 25 °C | 700 | |
| T _{stg} | Storage temperature range | | -65 to +175 | °C | |
| T _j | Operating junction temperature range | | -40 to +175 | °C | |

Table 3: Thermal resistance parameters

| Symbol | Parameter | | Typ. value | Max. value | Unit |
|----------------------|------------------|------------|------------|------------|------|
| R _{th(j-c)} | Junction to case | Per diode | 0.40 | 0.55 | °C/W |
| | | Per device | 0.20 | 0.28 | |

Table 4: Static electrical characteristics (per diode)

| Symbol | Parameter | Test conditions | | Min. | Typ. | Max. | Unit |
|-------------------------------|-------------------------|-------------------------|-----------------------------------|------|------|------|------|
| I _R ⁽¹⁾ | Reverse leakage current | T _j = 25 °C | V _R = V _{RRM} | - | 10 | 120 | μA |
| | | T _j = 150 °C | | - | 60 | 800 | |
| V _F ⁽²⁾ | Forward voltage drop | T _j = 25 °C | I _F = 20 A | - | 1.35 | 1.50 | V |
| | | T _j = 150 °C | | - | 1.75 | 2.25 | |

Notes:

(1)Pulse test: t_p = 10 ms, δ < 2%

(2)Pulse test: t_p = 500 μs, δ < 2%

To evaluate the conduction losses, use the following equation:

$$P = 1.07 \times I_{F(AV)} + 0.059 \times I_{F(RMS)}^2$$

Table 5: Dynamic electrical characteristics (per diode)

| Symbol | Parameter | Test conditions | Min. | Typ. | Max. | Unit |
|----------------|-------------------------|---|------|------|------|------|
| $Q_{Cj}^{(1)}$ | Total capacitive charge | $V_R = 800 \text{ V}$ | - | 129 | - | nC |
| C_j | Total capacitance | $V_R = 0 \text{ V}, T_c = 25 \text{ }^\circ\text{C}, F = 1 \text{ MHz}$ | - | 1650 | - | pF |
| | | $V_R = 800 \text{ V}, T_c = 25 \text{ }^\circ\text{C}, F = 1 \text{ MHz}$ | - | 110 | - | |

Notes:

⁽¹⁾Most accurate value for the capacitive charge: $Q_{Cj}(V_R) = \int_0^{V_R} C_j(V) dV$

1.1 Characteristics (curves)

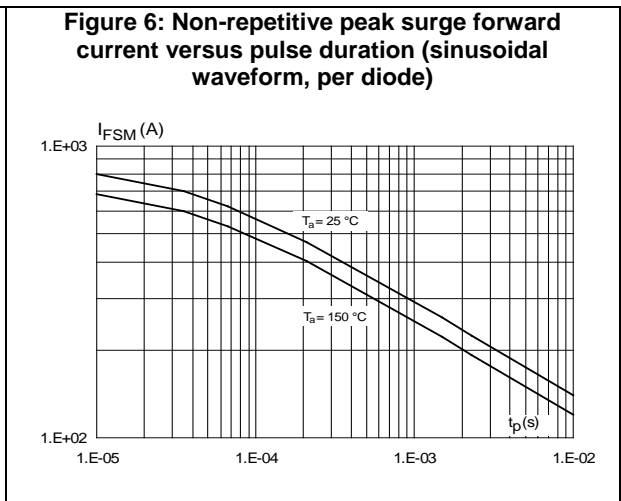
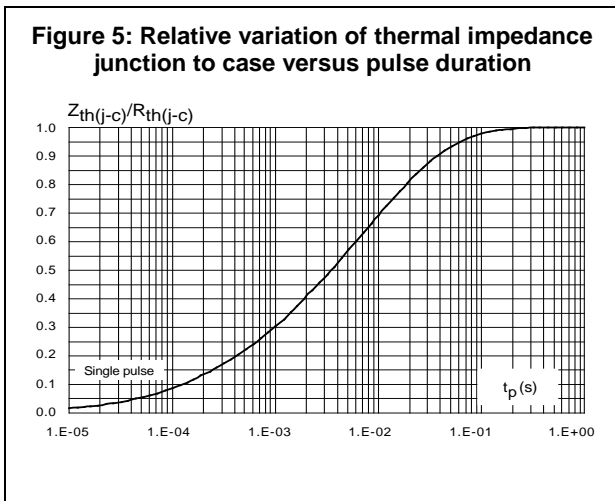
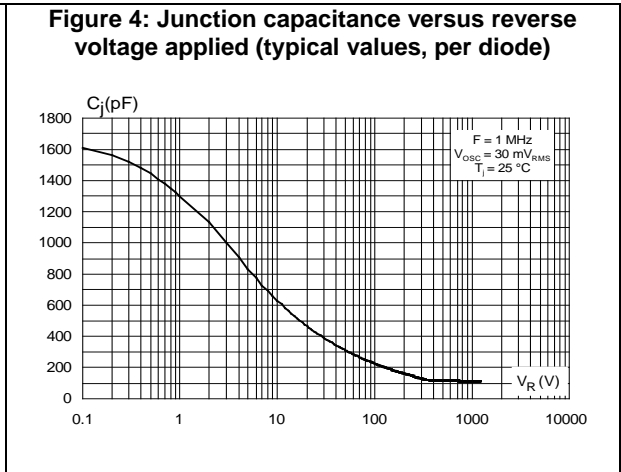
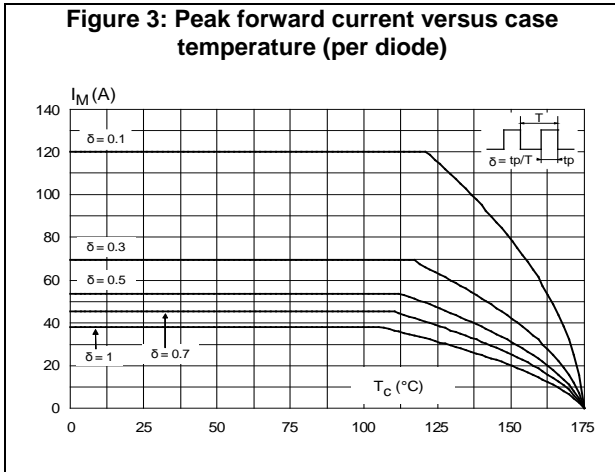
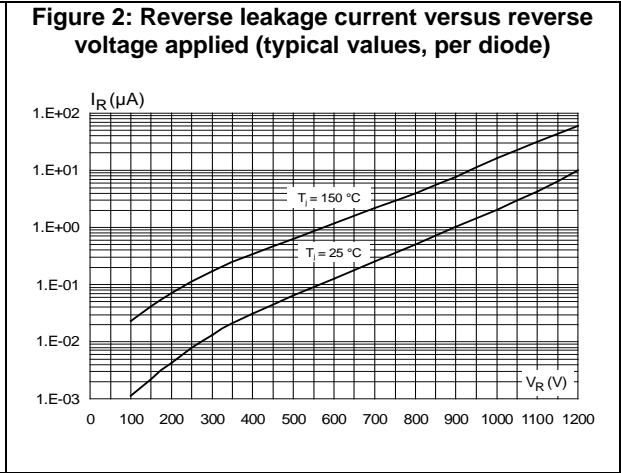
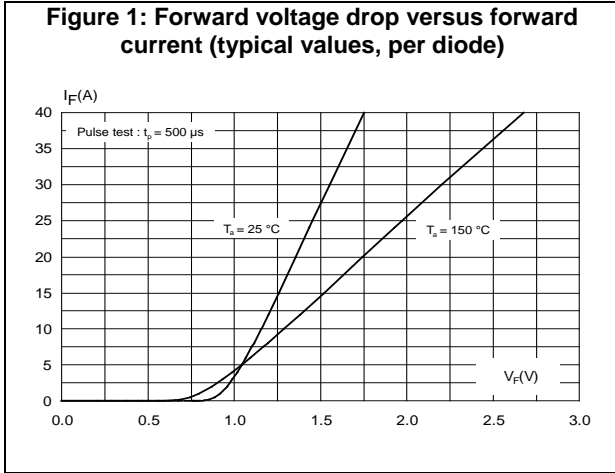
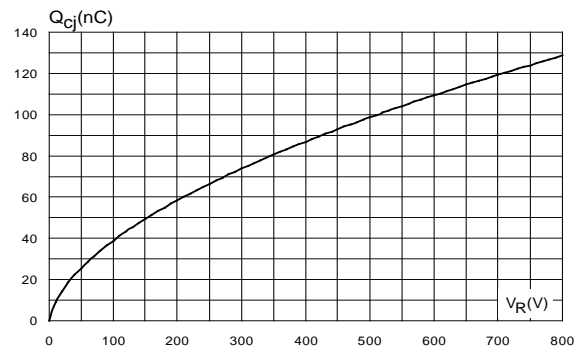

Figure 7: Total capacitive charges versus reverse voltage applied (typical values, per diode)



2 Package information

In order to meet environmental requirements, ST offers these devices in different grades of ECOPACK® packages, depending on their level of environmental compliance. ECOPACK® specifications, grade definitions and product status are available at: www.st.com. ECOPACK® is an ST trademark.

- Epoxy meets UL94, V0
- Cooling method: by conduction (C)
- Recommended torque value: 0.9 to 1.2 N·m

2.1 TO-247 long leads package information

Figure 8: TO-247 long leads package outline

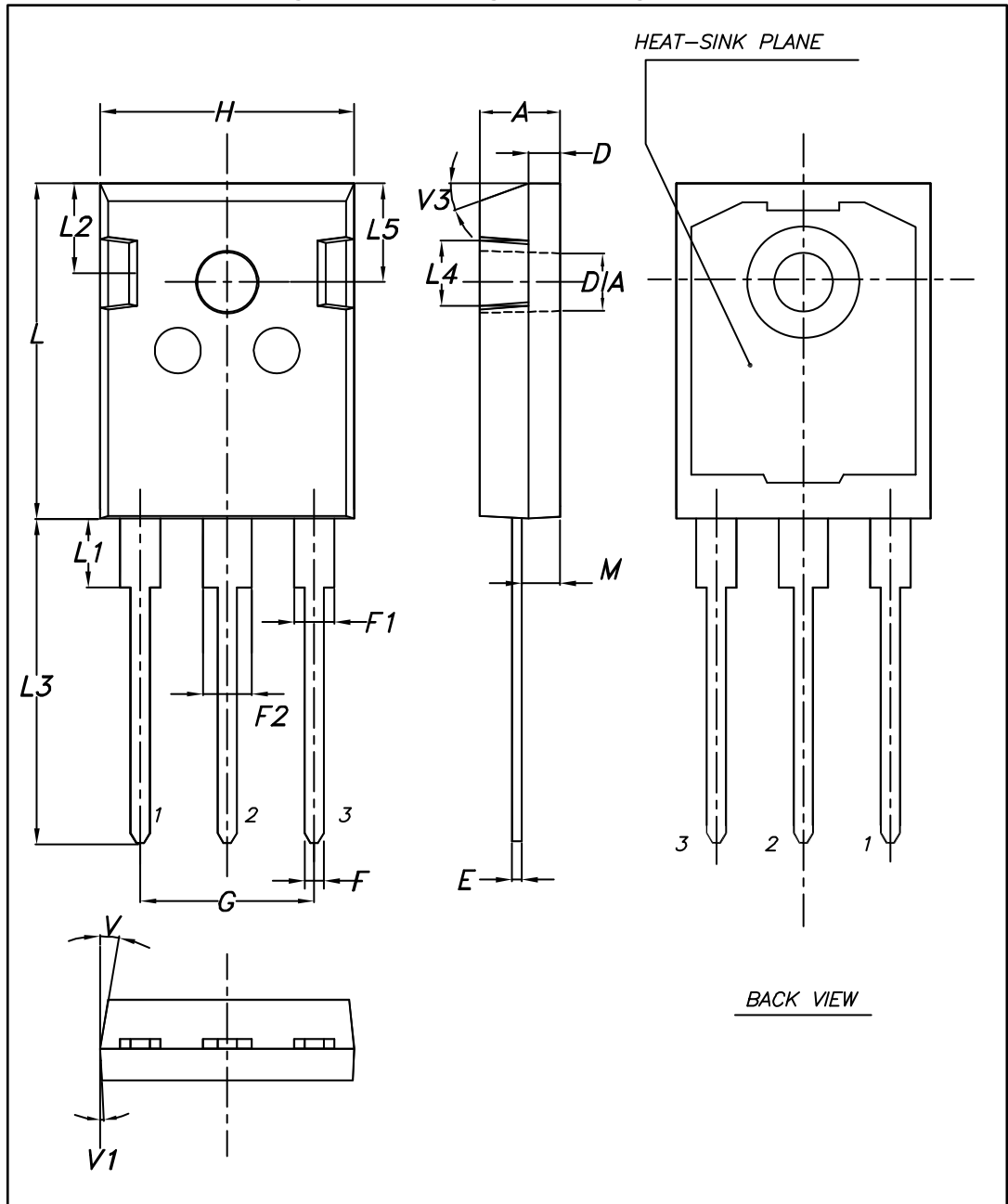

Table 6: TO-247 long leads package mechanical data

| Dim. | mm. | | | Inches | | |
|------|-----------|------|-------|-----------|------|-------|
| | Min. | Typ. | Max. | Min. | Typ. | Max. |
| A | 4.90 | | 5.15 | 0.192 | | 0.202 |
| D | 1.85 | | 2.10 | 0.072 | | 0.082 |
| E | 0.55 | | 0.67 | 0.021 | | 0.026 |
| F | 1.07 | | 1.32 | 0.042 | | 0.051 |
| F1 | 1.90 | | 2.38 | 0.074 | | 0.093 |
| F2 | 2.87 | | 3.38 | 0.110 | | 0.133 |
| G | 10.90 BSC | | | 0.429 BSC | | |
| H | 15.77 | | 16.02 | 0.620 | | 0.630 |
| L | 20.82 | | 21.07 | 0.810 | | 0.820 |
| L1 | 4.16 | | 4.47 | 0.163 | | 0.175 |
| L2 | 5.49 | | 5.74 | 0.216 | | 0.225 |
| L3 | 20.05 | | 20.30 | 0.789 | | 0.799 |
| L4 | 3.68 | | 3.93 | 0.144 | | 0.154 |
| L5 | 6.04 | | 6.29 | 0.237 | | 0.247 |
| M | 2.25 | | 2.55 | 0.088 | | 0.100 |
| V | | 10° | | | 10° | |
| V1 | | 3° | | | 3° | |
| V3 | | 20° | | | 20° | |
| DIA | 3.55 | | 3.66 | 0.139 | | 0.143 |

3 Ordering information

Table 7: Ordering information

| Order code | Marking | Package | Weight | Base qty. | Delivery mode |
|---------------|---------------|-----------|--------|-----------|---------------|
| STPSC40H12CWL | STPSC40H12CWL | TO-247 LL | 6.09 g | 30 | Tube |

4 Revision history

Table 8: Document revision history

| Date | Revision | Changes |
|-------------|----------|------------------|
| 28-Feb-2017 | 1 | Initial release. |

IMPORTANT NOTICE – PLEASE READ CAREFULLY

STMicroelectronics NV and its subsidiaries ("ST") reserve the right to make changes, corrections, enhancements, modifications, and improvements to ST products and/or to this document at any time without notice. Purchasers should obtain the latest relevant information on ST products before placing orders. ST products are sold pursuant to ST's terms and conditions of sale in place at the time of order acknowledgement.

Purchasers are solely responsible for the choice, selection, and use of ST products and ST assumes no liability for application assistance or the design of Purchasers' products.

No license, express or implied, to any intellectual property right is granted by ST herein.

Resale of ST products with provisions different from the information set forth herein shall void any warranty granted by ST for such product.

ST and the ST logo are trademarks of ST. All other product or service names are the property of their respective owners.

Information in this document supersedes and replaces information previously supplied in any prior versions of this document.

© 2017 STMicroelectronics – All rights reserved

X-ON Electronics

Largest Supplier of Electrical and Electronic Components

Click to view similar products for [Schottky Diodes & Rectifiers](#) category:

Click to view products by [STMicroelectronics](#) manufacturer:

Other Similar products are found below :

[MA4E2039](#) [D1FH3-5063](#) [MBR10100CT-BP](#) [MBR1545CT](#) [MMBD301M3T5G](#) [RB160M-50TR](#) [RB551V-30](#) [BAS16E6433HTMA1](#) [BAT](#)
[54-02LRH E6327](#) [NSR05F40QNXT5G](#) [NTE555](#) [JANS1N6640](#) [SB07-03C-TB-H](#) [SB1003M3-TL-W](#) [SK310-T](#) [SK32A-LTP](#) [SK33A-TP](#)
[SK34B-TP](#) [SS3003CH-TL-E](#) [GA01SHT18](#) [CRS10I30A\(TE85L,QM](#) [MA4E2501L-1290](#) [MBRB30H30CT-1G](#) [SB007-03C-TB-E](#) [SK32A-TP](#)
[SK33B-TP](#) [SK35A-TP](#) [SK38B-TP](#) [NRVBM120LT1G](#) [NTE505](#) [NTSB30U100CT-1G](#) [SS15E-TP](#) [VS-6CWQ10FNHM3](#) [ACDBA1100LR-HF](#)
[ACDBA1200-HF](#) [ACDBA140-HF](#) [ACDBA2100-HF](#) [ACDBA3100-HF](#) [CDBQC0530L-HF](#) [CDBQC0240LR-HF](#) [ACDBA340-HF](#)
[ACDBA260LR-HF](#) [ACDBA1100-HF](#) [SK310B-TP](#) [MA4E2502L-1246](#) [MA4E2502H-1246](#) [NRVBM120ET1G](#) [NSR01L30MXT5G](#) [NTE573](#)
[NTE6081](#)