

## Parascan™ tunable integrated capacitor

Datasheet - production data

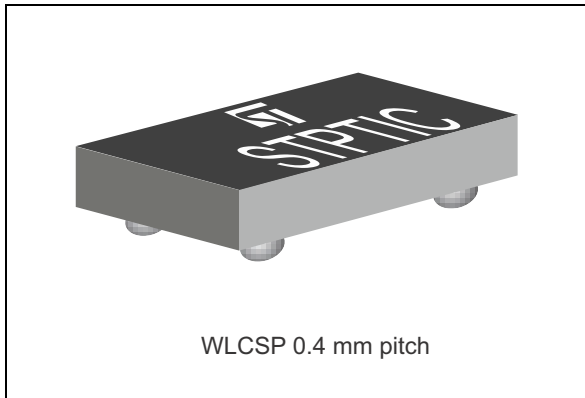

### Features

- High power capability
- 5:1 tuning range
- High linearity
- High quality factor (Q)
- Low leakage current
- Compatible with high voltage control IC (STHVDAC series)
- Available in wafer level chip scale package:
  - WLCSP package 0.6 x 0.8 x 0.3 mm
- ECOPACK®2 compliant component

### Benefit

- RF tunable passive implementation in mobile phones to optimize antenna radiated performance

### Applications

- Cellular antenna open loop tunable matching network in multi-band GSM/WCDMA/LTE mobile phone
- Open loop tunable RF filters

### Description

The ST integrated tunable capacitor offers excellent RF performance, low power consumption and high linearity required in adaptive RF tuning applications. The fundamental building block of PTIC is a tunable material called Parascan™, which is a version of barium strontium titanate (BST) developed by Paratek microwave.

BST capacitors are tunable capacitors intended for use in mobile phone application and dedicated to RF tunable applications. These tunable capacitors are controlled through an extended bias voltage ranging from 1 to 24 V. The implementation of BST tunable capacitor in mobile phones enables significant improvement in terms of radiated performance making the performance almost insensitive to the external environment.

**Figure 1. PTIC functional block diagram**

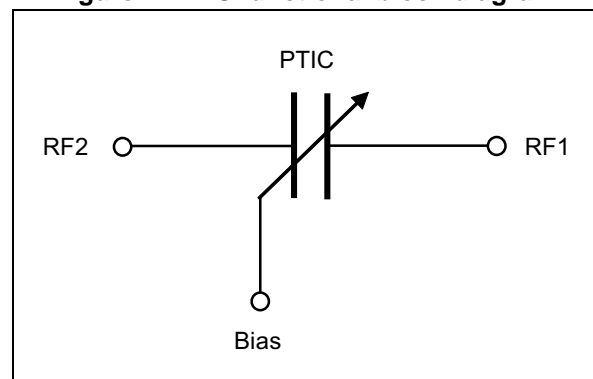

TM: Parascan is a trademark of Paratek Microwave Inc.

# 1 Electrical characteristics

**Table 1. Absolute maximum ratings (limiting values)**

Symbol	Parameter	Rating	Unit
$P_{IN}$	Input peak power $RF_{IN}$ (CW mode)/all RF ports	+40	dBm
$V_{ESD(HBM)}$	Human body model, JESD22-A114-B, all I/O	Class 1B <sup>(1)</sup>	V
$V_{ESD(MM)}$	Machine model, JESD22-A115-A, all I/O	100	V
$T_{device}$	Device temperature	+125	°C
$T_{stg}$	Storage temperature	-55 to +150	
$V_x$	Bias voltage	25	V

1. Class 1B defined as passing 500 V, but fails after exposure to 1000V ESD pulse.

**Table 2. Recommended operating conditions**

Symbol	Parameter	Rating			Unit
		Min.	Typ.	Max.	
$P_{IN}$	RF input power		+33		dBm
$F_{OP}$	Operating frequency	700		2700	MHz
$T_{device}$	Device temperature			+100	°C
$T_{OP}$	Operating temperature	-30		+85	
$V_{BIAS}$	Bias voltage	1		24	V

Table 3. Representative performance ( $T_{amb} = 25\text{ }^{\circ}\text{C}$  otherwise specified)

Symbol	Parameter	Conditions	Value			Unit
			Min	Typ	Max	
$C_{1V}$	capacitor at 1 V bias	STPTIC-68G2	6.86	7.8	8.74	pF
$C_{2V}$	capacitor at 2 V bias	STPTIC-68G2		6.8		pF
$C_{24V}$	capacitor at 24 V bias	STPTIC-68G2	1.24	1.35	1.46	pF
$\Delta C$	Tuning range	Ratio between $C_{1V}/C_{24V}$ <sup>(1)</sup>	5/1			
$I_L$	Leakage current	Measured with $V_{bias} = 24\text{ V}$			100	nA
$Q_{LB}$	Quality factor	Measured at 700 MHz at 2 V	55	65		
$Q_{HB}$	Quality factor	Measured at 2700 MHz at 2 V	35	50		
IP3	Third order intercept point	$V_{bias} = 1\text{ V}$ <sup>(2)(4)</sup>	52	60		dBm
		$V_{bias} = 24\text{ V}$ <sup>(2)(4)</sup>		75		
H2	Second harmonic	$V_{bias} = 1\text{ V}$ <sup>(3)(4)</sup>		-65	-45	dBm
		$V_{bias} = 24\text{ V}$ <sup>(3)(4)</sup>		-75		
H3	Third harmonic	$V_{bias} = 1\text{ V}$ <sup>(3)(4)</sup>		-35	-30	dBm
		$V_{bias} = 24\text{ V}$ <sup>(3)(4)</sup>		-65		
$t_T$	Transition time	Average for any transition between $C_{min}$ to $C_{max}$ <sup>(5)</sup>		40		$\mu\text{s}$
		Average transition between $C_{max}$ to $C_{min}$ <sup>(5)</sup>		20		

1. Measured at low frequency
2.  $F_1 = 894\text{ MHz}$ ,  $F_2 = 849\text{ MHz}$ ,  $P_1 = +25\text{ dBm}$ ,  $P_2 = +25\text{ dBm}$ ,  $2f_1 - f_2 = 939\text{ MHz}$
3.  $850\text{ MHz}$ ,  $P_{in} = +34\text{ dBm}$
4. IP3 and harmonics are measured in the shunt configuration in a  $50\ \Omega$  environment
5. One or both of  $RF_{in}$  and  $RF_{out}$  must be connected to DC ground, using the HVDAC turbo mode

**Figure 2. Capacitor variation versus bias voltage**

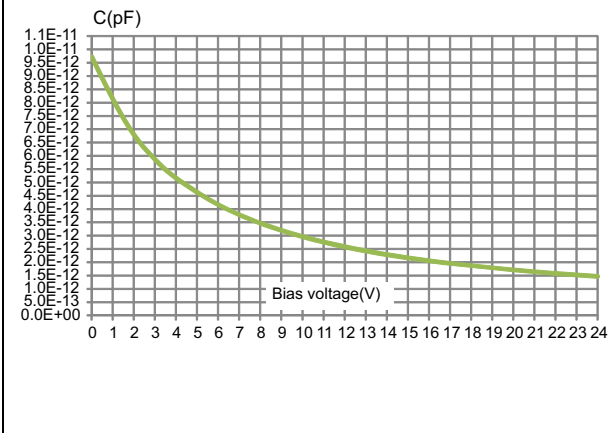

**Figure 3. Quality factor versus frequency**

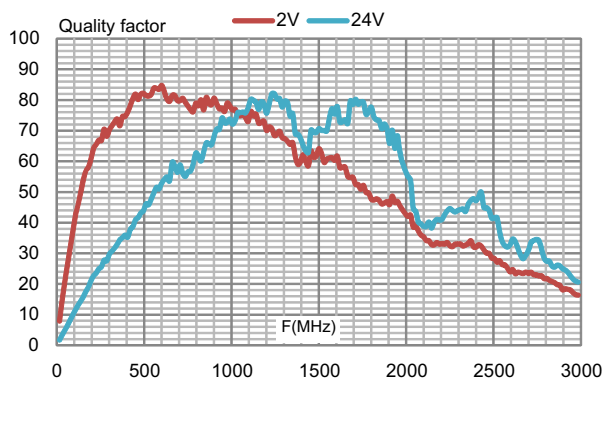

**Figure 4. Harmonic power versus bias voltage (series)**

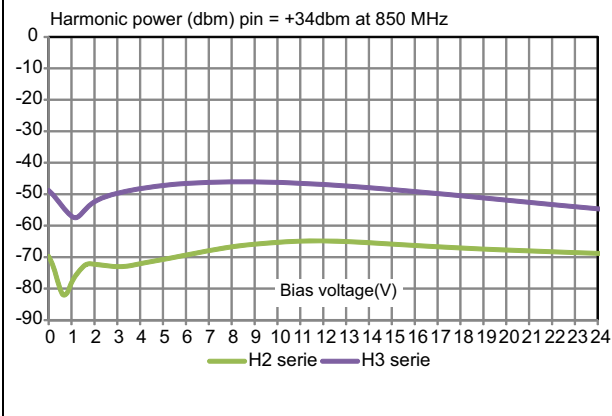

**Figure 5. Harmonic power versus bias voltage (shunt)**

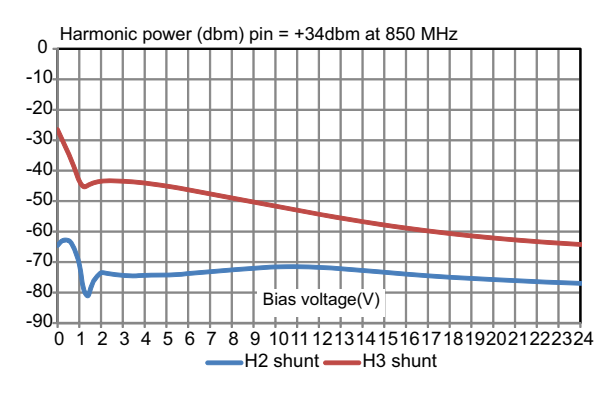

**Figure 6. Third order intercept point (IP3)**

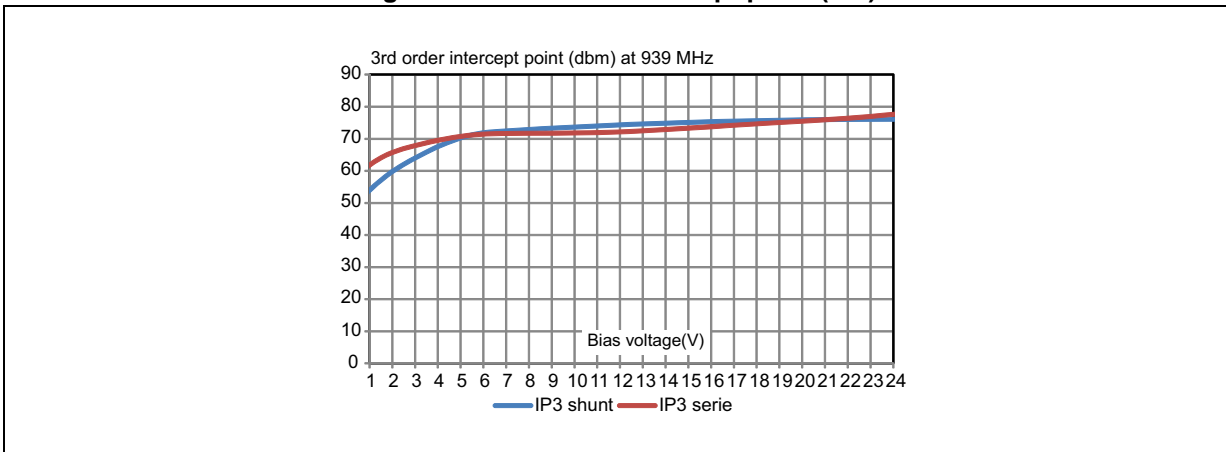

## 2 Package information

- Epoxy meets UL94, V0
- Lead-free package

In order to meet environmental requirements, ST offers these devices in different grades of ECOPACK® packages, depending on their level of environmental compliance. ECOPACK® specifications, grade definitions and product status are available at: [www.st.com](http://www.st.com). ECOPACK® is an ST trademark.

### 2.1 Flip-Chip package information

Figure 7. Flip-Chip package outline

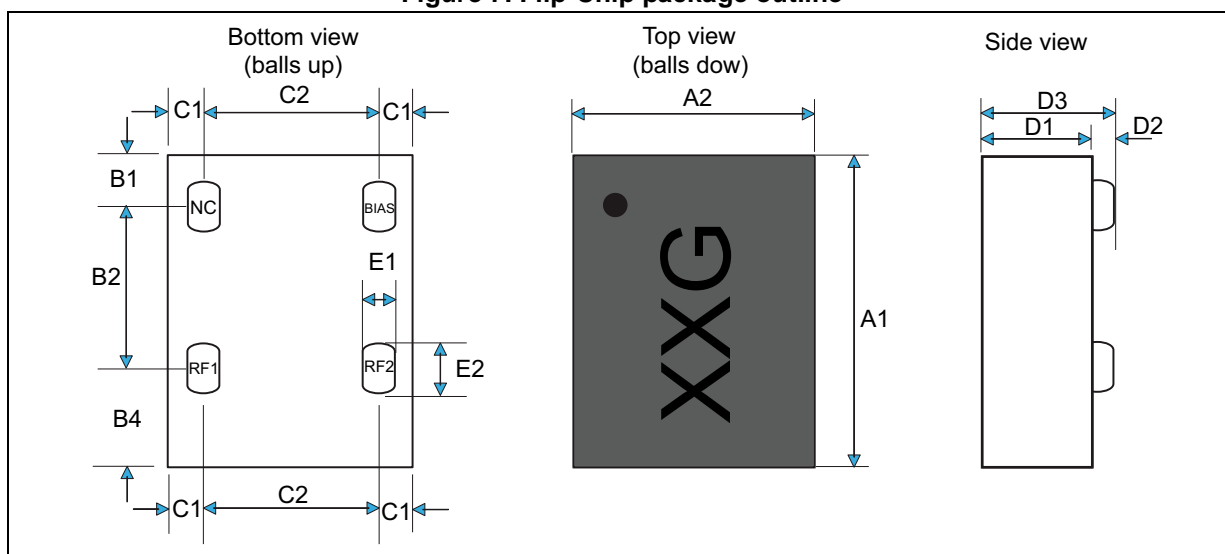

The land pattern below is recommended for soldering the STPTIC-G2 on PCB.

NC stands for No Connect, this pad must not be connected on application board. Please leave this pad floating.

Table 4. Flip-Chip package dimensions

Dimensions (micron)	A1	A2	B1	B2	B4	C1	C2	D1	D2	D3	E1	E2
STPTIC-15/27/33/39/47G2	640	590	120	400	120	85	420	200	90	290	125	165
STPTIC-56G2	710				190							
STPTIC-68G2	780				260							
STPTIC-82G2	880				360							
Tolerance	±30	±30	±15	±10	±15	±15	±10	±20	±20	±40	±20	±20

Figure 8. Recommended PCB land pattern for Flip-Chip package

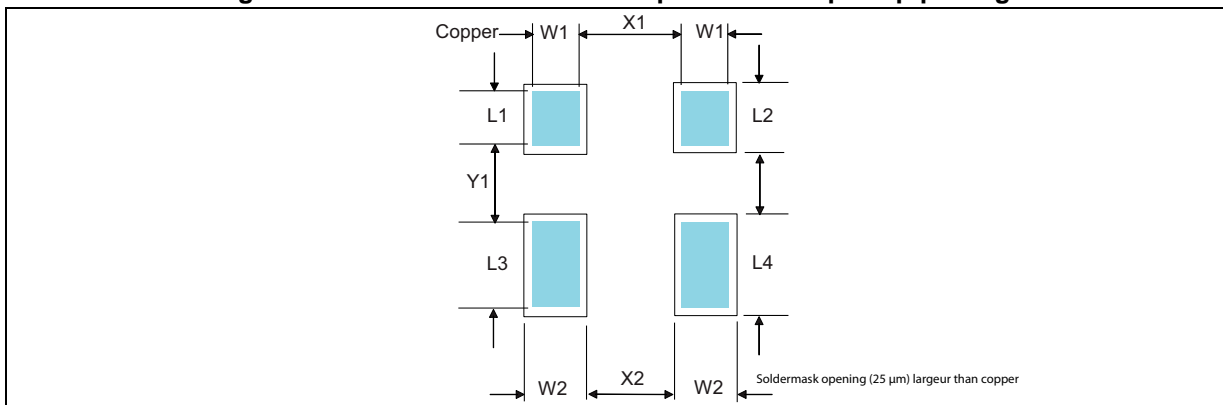

Table 5. Dimensions

Dimensions	L1	W1	L3	L2	W2	L4	X1	X2	Y1	Y2
Typical values (micron)	160	160	260	210	210	310	320	270	240	190

## 2.2 Packing information

Figure 9. Flip-Chip tape and reel outline

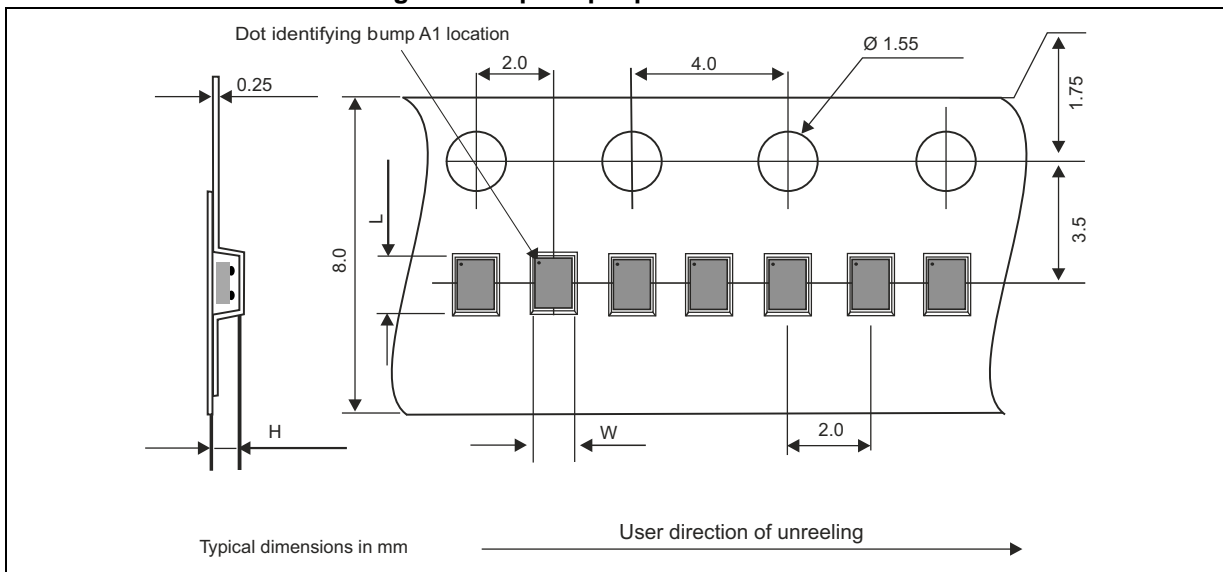

Table 6. Dimensions

Pocket dimensions	L	W	H
STPTIC-15/27/33/39/47G2	730	680	380
STPTIC-56G2	800	680	380
STPTIC-68G2	870	680	380
STPTIC-82G2	970	680	380

Figure 10. Flip-Chip marking

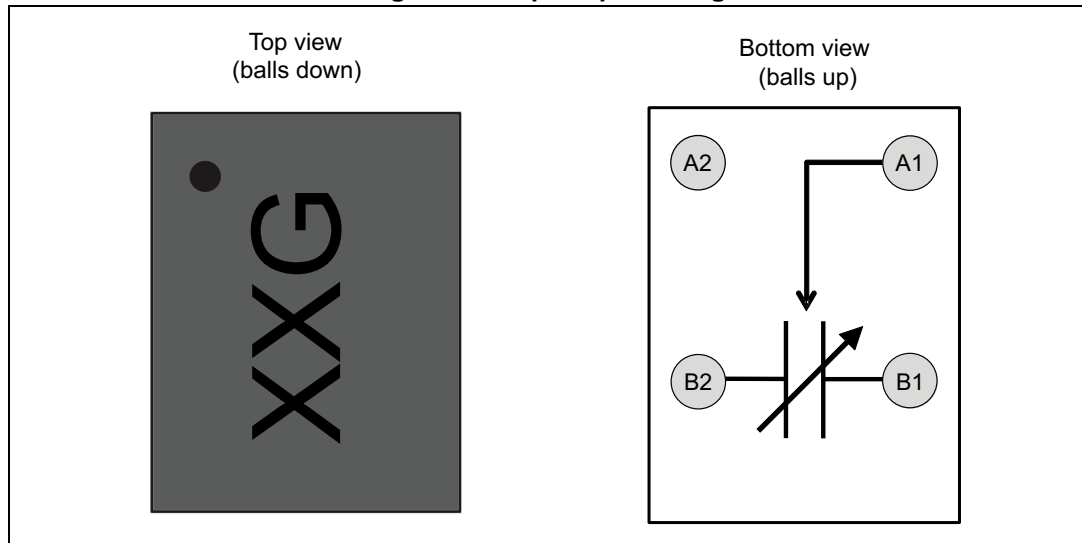

Table 7. Pinout description

Pad / ball number	Pin name	Description
A1	DC bias	DC bias voltage
B1	RF2	RF input / output <sup>(1)</sup>
A2	NC	Not connected
B2	RF1	RF input / output

1. When connected in shunt, please connect RF2 (B1 ball) to GND

### 3 Reflow profile

Figure 11. ST ECOPACK® recommended soldering reflow profile for PCB mounting

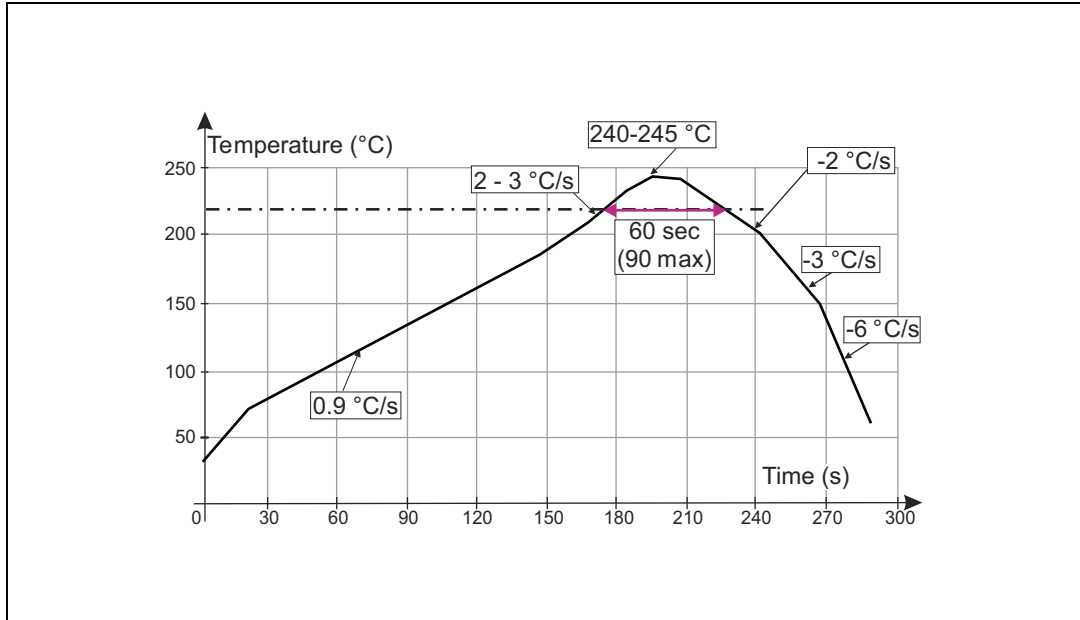

Note: Minimize air convection currents in the reflow oven to avoid component movement.

Table 8. Recommended values for soldering reflow

Profile	Value	
	Typical	Max.
Temperature gradient in preheat (T = 70-180 °C)	0.9 °C/s	3 °C/s
Temperature gradient (T = 200-225 °C)	2 °C/s	3 °C/s
Peak temperature in reflow	240-245 °C	260 °C
Time above 220 °C	60 s	90 s
Temperature gradient in cooling	-2 to -3 °C/s	-6 °C/s
Time from 50 to 220 °C	160 to 220 s	



# 4 Evaluation board

Figure 12. Series and shunt connection

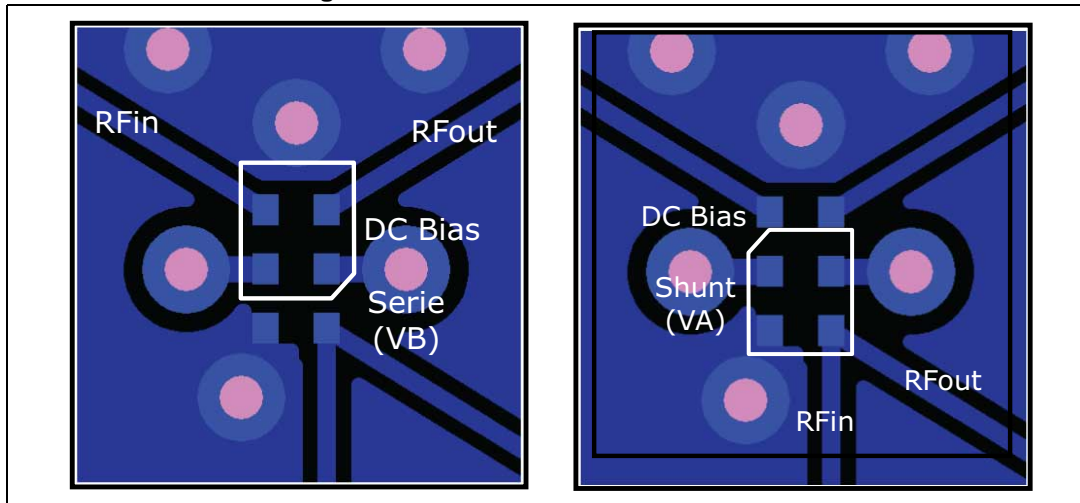

Figure 13. Layer 1 and layer 4

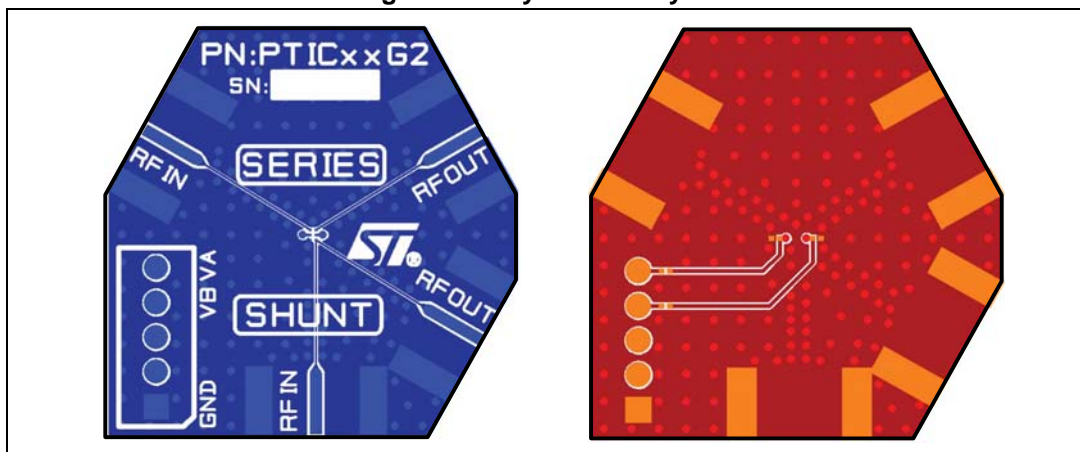
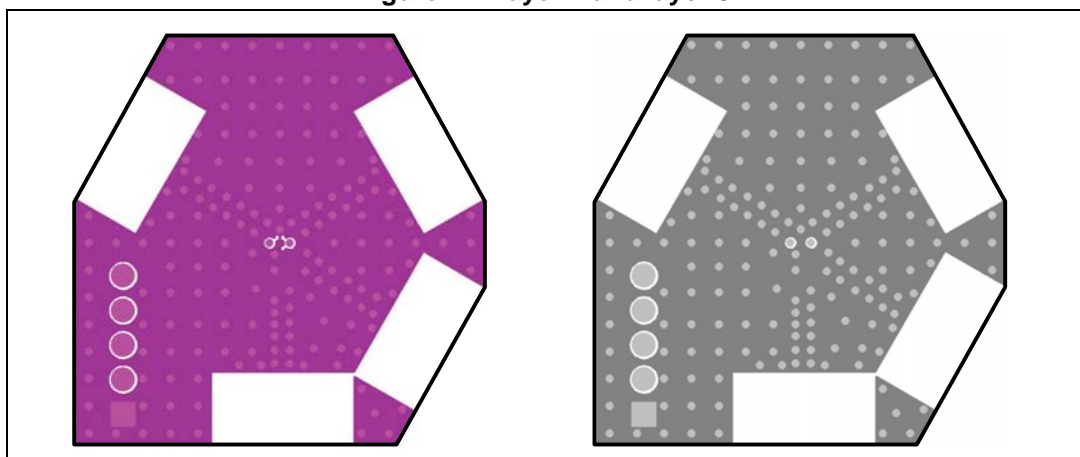

Figure 14. Layer 2 and layer 3



## 5 Ordering information

Figure 15. Ordering information scheme

<b>ST</b>	<b>PTIC</b>	<b>-</b>	<b>15</b>	<b>G</b>	<b>2</b>	<b>C5</b>
<u>Manufacturer</u>	<u>Product family</u>	<b>-</b>	<u>Capacitor value</u>	<u>Linearity</u>	<u>Tuning</u>	<u>Package</u>
ST Microelectronics	PTIC Parascan™ tunable Integrated capacitor		12 = 1.2 pF 27 = 2.7 pF 33 = 3.3 pF 39 = 3.9 pF 47 = 4.7 pF 56 = 5.6 pF 68 = 6.8 pF 82 = 8.2 pF	F: Standard (x24) G: Standard (x24) L: High (x48)	1 = 4/1 tuning 2 = 5/1 tuning	M6 : QFN C5 : WLCSP

Table 9. Ordering information

Part number	Marking	Base qty	Package	Delivery mode
STPTIC-68G2C5	68G	15 000	Flip-Chip	Tape and reel

## 6 Revision history

Table 10. Document revision history

Date	Revision	Changes
09-Jul-2015	1	Initial release.

**IMPORTANT NOTICE – PLEASE READ CAREFULLY**

STMicroelectronics NV and its subsidiaries (“ST”) reserve the right to make changes, corrections, enhancements, modifications, and improvements to ST products and/or to this document at any time without notice. Purchasers should obtain the latest relevant information on ST products before placing orders. ST products are sold pursuant to ST’s terms and conditions of sale in place at the time of order acknowledgement.

Purchasers are solely responsible for the choice, selection, and use of ST products and ST assumes no liability for application assistance or the design of Purchasers’ products.

No license, express or implied, to any intellectual property right is granted by ST herein.

Resale of ST products with provisions different from the information set forth herein shall void any warranty granted by ST for such product.

ST and the ST logo are trademarks of ST. All other product or service names are the property of their respective owners.

Information in this document supersedes and replaces information previously supplied in any prior versions of this document.

© 2015 STMicroelectronics – All rights reserved

## X-ON Electronics

Largest Supplier of Electrical and Electronic Components

*Click to view similar products for [Trimmer/Variable Capacitors](#) category:*

*Click to view products by [STMicroelectronics](#) manufacturer:*

Other Similar products are found below :

[GKY20086](#) [GNC8R050](#) [GXA18000](#) [GXA36000](#) [GXC90000](#) [GXE5R000NM](#) [GXL10000](#) [GZN60100](#) [PC50H230](#) [PC50J110](#) [PC51H230](#)  
[GDT40026](#) [GKU90020](#) [GNR4R550](#) [GNR8R050](#) [GXL15000](#) [538-011 D 9-35LF](#) [PC39G520](#) [STPTIC-56G2C5](#) [27271LSL](#) [27281SL](#)  
[STPTIC-82G2C5](#) [27283-3R10](#) [GNL8R050](#) [GYB5R000](#) [0538-006-F-15.0-60LF](#) [GXL18000](#) [GHC5R500](#) [GZD80000](#) [TP11G](#) [KT1SD](#) [KF8](#)  
[KP8](#) [KM8](#) [KG8](#) [KJ8](#) [KT8](#) [KG10](#) [KP10](#) [KF10](#) [KJ10](#) [KM10](#) [TP42C](#) [NMAJ25HV](#) [KF4SD](#) [KJ1SD](#) [KP1SD](#) [KM4SD](#) [KT4SD](#) [KP4SD](#)