

Turbo 2 ultrafast high voltage rectifier

Datasheet – production data

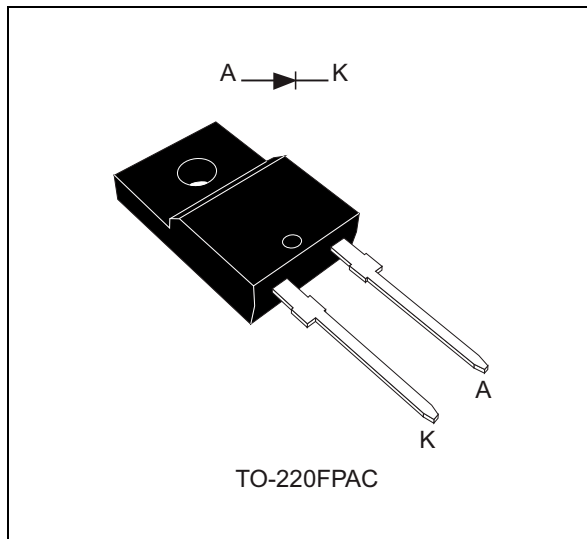

Features

- Ultrafast switching
- Low reverse current
- Reduces switching and conduction losses
- Low thermal resistance
- Insulated package TO-220FPAC:
 - Insulated voltage: 2000 V_{RMS} sine

Description

The STTH15AC06 uses ST Turbo 2 600 V technology and is suited as a boost diode in air conditioning equipment for continuous mode interleaved power factor correction.

The device is also intended for use as a freewheeling diode in power supplies and other power switching applications.

Table 1. Device summary

Symbol	Value
$I_{F(AV)}$	15 A
V_{RRM}	600 V
t_{rr} (typ)	40 ns
V_F (typ)	1.15 V
T_j (max)	175 °C

1 Characteristics

Table 2. Absolute ratings (limiting values at 25 °C, unless otherwise specified)

Symbol	Parameter	Value	Unit	
V_{RRM}	Repetitive peak reverse voltage	600	V	
$I_{F(RMS)}$	Forward rms current	30	A	
$I_{F(AV)}$	Average forward current	15	A	
I_{FSM}	Surge non repetitive forward current	$t_p = 10$ ms sinusoidal	120	A
T_{stg}	Storage temperature range	-65 to +175	°C	
T_j	Maximum operating junction temperature	175	°C	

Table 3. Thermal parameters

Symbol	Parameter	Value	Unit
$R_{th(j-c)}$	Junction to case	4.4	°C/W

Table 4. Static electrical characteristics

Symbol	Parameter	Test conditions	Min.	Typ.	Max.	Unit
$I_R^{(1)}$	Reverse leakage current	$T_j = 25$ °C	$V_R = V_{RRM}$		2	μ A
		$T_j = 150$ °C		20	200	
$V_F^{(2)}$	Forward voltage drop	$T_j = 25$ °C	$I_F = 15$ A		1.9	V
		$T_j = 150$ °C		1.15	1.50	

1. Pulse test: $t_p = 5$ ms, $\delta < 2\%$
2. Pulse test: $t_p = 380$ μ s, $\delta < 2\%$

To evaluate the conduction losses use the following equation:

$$P = 1.2 \times I_{F(AV)} + 0.02 I_{F(RMS)}^2$$

Table 5. Dynamic characteristics

Symbol	Parameter	Test conditions	Min.	Typ.	Max.	Unit	
t_{rr}	Reverse recovery time	$T_j = 25$ °C	$I_F = 0.5$ A, $I_{rr} = 0.25$ A, $I_R = 1$ A		30	ns	
				40	55		
I_{RM}	Reverse recovery current	$T_j = 125$ °C	$I_F = 15$ A, $V_R = 400$ V, $di_F/dt = -100$ A/ μ s		4.4	6	A
t_{fr}	Forward recovery time	$T_j = 25$ °C	$I_F = 15$ A, $V_{FR} = 1.6$ V, $di_F/dt = 100$ A/ μ s		300	ns	
V_{FP}	Forward recovery voltage				2.5	V	

Figure 1. Average forward power dissipation versus average forward current

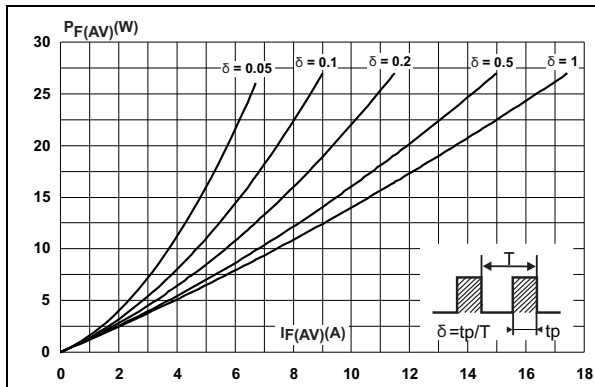

Figure 2. Forward voltage drop versus forward current (typical values)

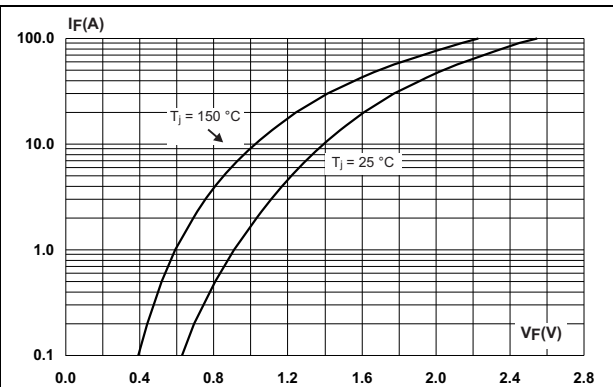

Figure 3. Forward voltage drop versus forward current (maximum values)

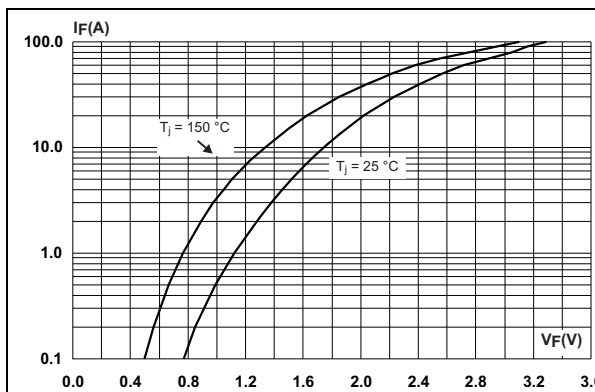

Figure 4. Relative variation of thermal impedance, junction to case, versus pulse duration

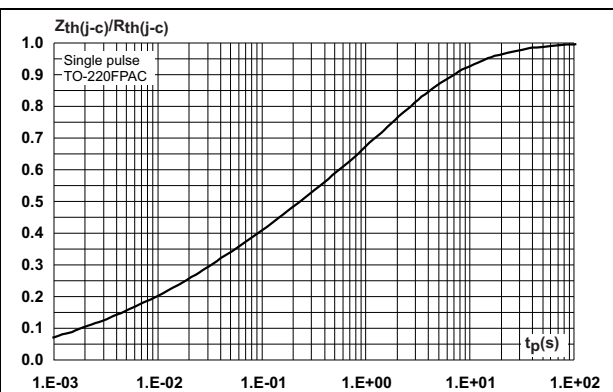

Figure 5. Peak reverse recovery current versus di_F/dt (typical values)

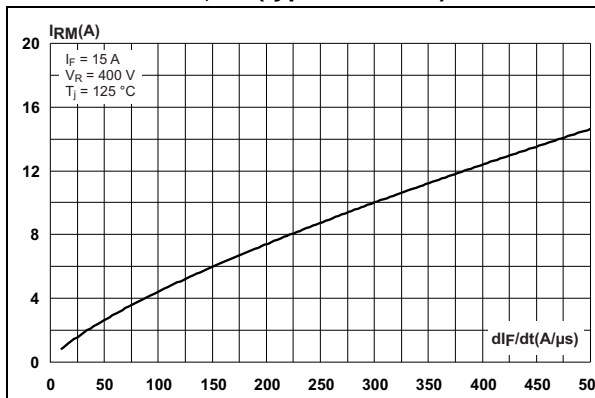

Figure 6. Reverse recovery time versus di_F/dt (typical values)

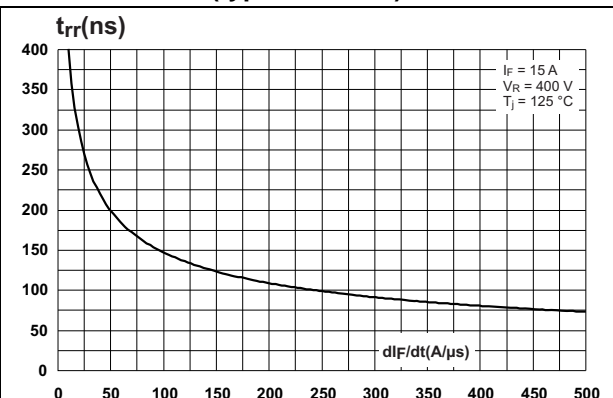

Figure 7. Reverse recovery charges versus di_F/dt (typical values)

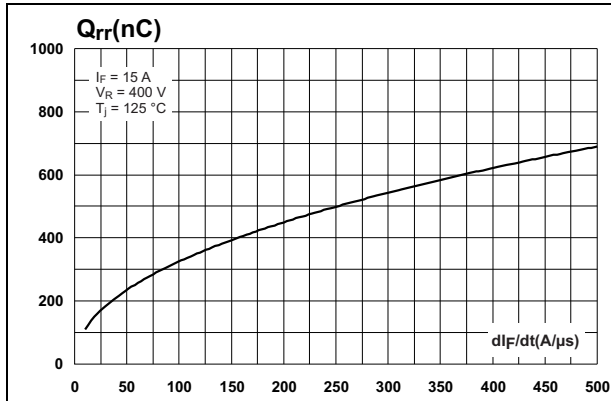

Figure 8. Reverse recovery softness factor versus di_F/dt (typical values)

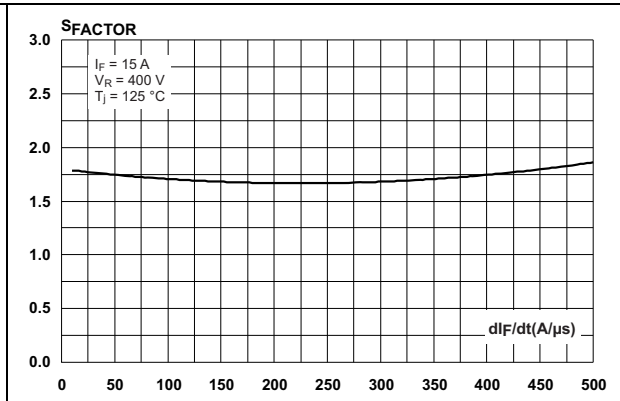

Figure 9. Relative variations of dynamic parameters versus junction temperature

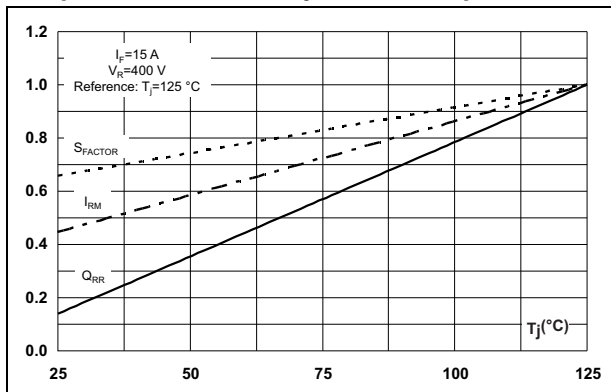

Figure 10. Transient peak forward voltage versus di_F/dt (typical values)

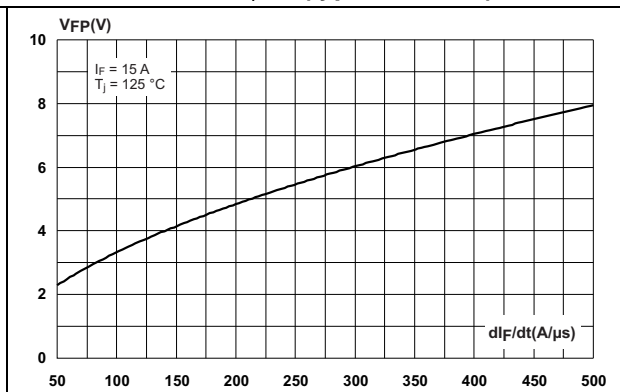

Figure 11. Forward recovery time versus di_F/dt (typical values)

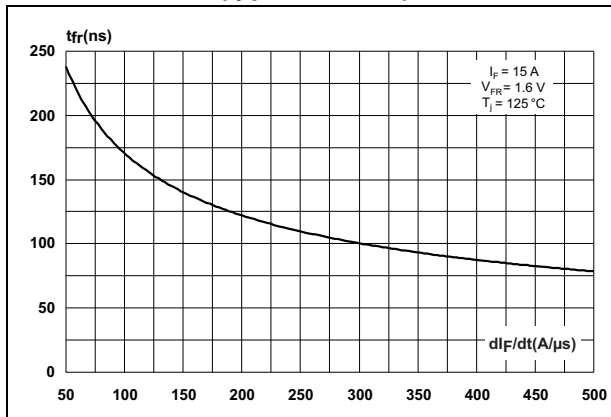
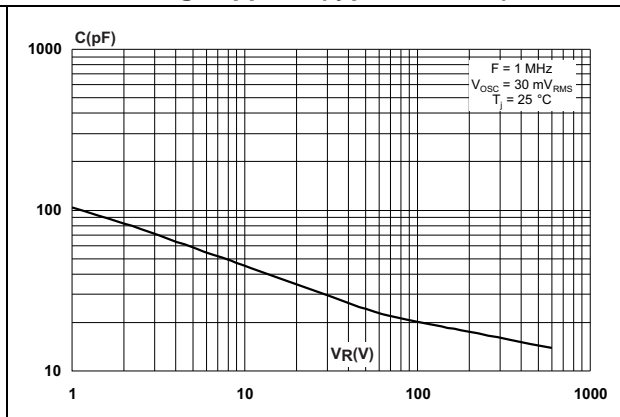

Figure 12. Junction capacitance versus reverse voltage applied (typical values)



2 Package information

- Epoxy meets UL94, V0
- Recommended torque value for TO-220FPAC: 0.55 N·m
- Maximum torque value for TO-220FPAC: 0.7 N·m

In order to meet environmental requirements, ST offers these devices in different grades of ECOPACK[®] packages, depending on their level of environmental compliance. ECOPACK[®] specifications, grade definitions and product status are available at: www.st.com. ECOPACK[®] is an ST trademark.

2.1 TO-220FPAC package information

Figure 13. TO-220FPAC package outline

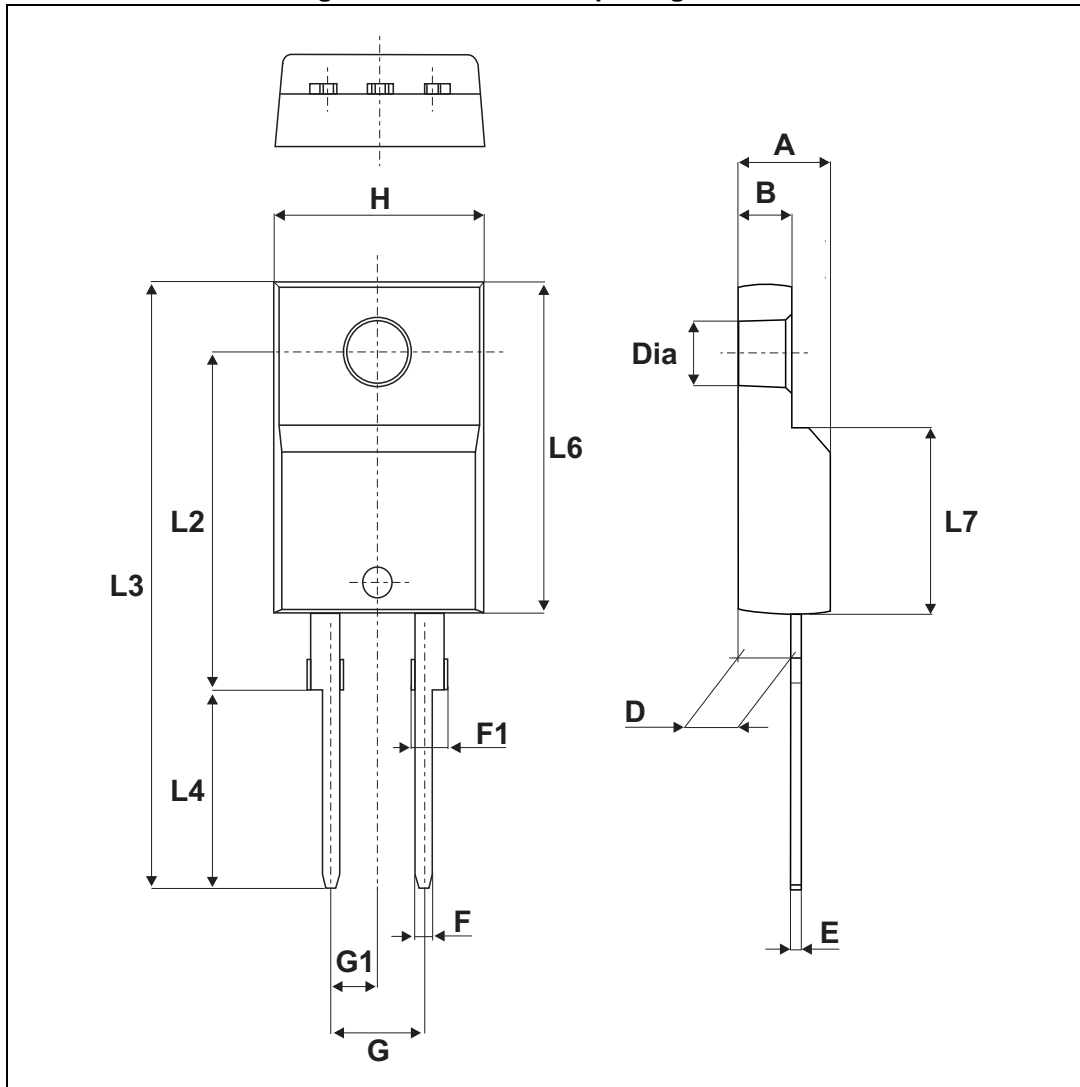

Table 6. TO-220FPAC package mechanical data

Ref.	Dimensions					
	Millimeters			Inches		
	Min.	Typ.	Max.	Min.	Typ.	Max.
A	4.4		4.6	0.173		0.181
B	2.5		2.7	0.098		0.106
D	2.5		2.75	0.098		0.108
E	0.45		0.70	0.018		0.027
F	0.75		1	0.030		0.039
F1	1.15		1.70	0.045		0.067
G	4.95		5.20	0.195		0.205
G1	2.4		2.7	0.094		0.106
H	10		10.4	0.393		0.409
L2		16 Typ.			0.63 Typ.	
L3	28.6		30.6	1.126		1.205
L4	9.8		10.6	0.386		0.417
L6	15.9		16.4	0.626		0.646
L7	9.00		9.30	0.354		0.366
Dia.	3.00		3.20	0.118		0.126

3 Ordering information

Table 7. Ordering information

Order code	Marking	Package	Weight	Base qty	Delivery mode
STTH15AC06FP	STTH15AC06FP	TO-220FPAC	1.8 g	50	Tube

4 Revision history

Table 8. Document revision history

Date	Revision	Changes
17-Apr-2014	1	First release.
24-Apr-2015	2	Updated Features and Table 3 .

IMPORTANT NOTICE – PLEASE READ CAREFULLY

STMicroelectronics NV and its subsidiaries (“ST”) reserve the right to make changes, corrections, enhancements, modifications, and improvements to ST products and/or to this document at any time without notice. Purchasers should obtain the latest relevant information on ST products before placing orders. ST products are sold pursuant to ST’s terms and conditions of sale in place at the time of order acknowledgement.

Purchasers are solely responsible for the choice, selection, and use of ST products and ST assumes no liability for application assistance or the design of Purchasers’ products.

No license, express or implied, to any intellectual property right is granted by ST herein.

Resale of ST products with provisions different from the information set forth herein shall void any warranty granted by ST for such product.

ST and the ST logo are trademarks of ST. All other product or service names are the property of their respective owners.

Information in this document supersedes and replaces information previously supplied in any prior versions of this document.

© 2015 STMicroelectronics – All rights reserved

X-ON Electronics

Largest Supplier of Electrical and Electronic Components

Click to view similar products for [Rectifiers](#) category:

Click to view products by [STMicroelectronics](#) manufacturer:

Other Similar products are found below :

[70HFR40](#) [RL252-TP](#) [150KR30A](#) [1N5397](#) [NTE5841](#) [NTE6038](#) [SCF5000](#) [1N4002G](#) [1N4005-TR](#) [JANS1N6640US](#) [481235F](#)
[RRE02VS6SGTR](#) [067907F](#) [MS306](#) [70HF40](#) [T85HFL60S02](#) [US2JFL-TP](#) [A1N5404G-G](#) [CRS04\(T5L,TEMQ\)](#) [ACGRA4007-HF](#)
[ACGRB207-HF](#) [CLH03\(TE16L,Q\)](#) [ACGRC307-HF](#) [ACEFC304-HF](#) [NTE6356](#) [NTE6359](#) [NTE6002](#) [NTE6023](#) [NTE6039](#) [NTE6077](#)
[85HFR60](#) [40HFR60](#) [70HF120](#) [85HFR80](#) [D126A45C](#) [SCF7500](#) [D251N08B](#) [SCHJ22.5K](#) [SM100](#) [SCPA2](#) [SCH10000](#) [SDHD5K](#) [VS-](#)
[12FL100S10](#) [ACGRA4001-HF](#) [D1821SH45T PR](#) [D1251S45T](#) [NTE5990](#) [NTE6358](#) [NTE6162](#) [NTE5850](#)