



STD3LN62K3, STF3LN62K3 STP3LN62K3, STU3LN62K3

N-channel 620 V, 2.5 Ω , 2.5 A SuperMESH3™ Power MOSFET
DPAK, TO-220FP, TO-220, IPAK

Features

Order codes	V _{DSS}	R _{DS(on) max}	I _D	P _D
STD3LN62K3	620 V	< 3 Ω	2.5 A	45 W
STF3LN62K3			2.5 A ⁽¹⁾	20 W
STP3LN62K3			2.5 A	45 W
STU3LN62K3			2.5 A	45 W

1. Limited by package

- 100% avalanche tested
- Extremely high dv/dt capability
- Very low intrinsic capacitance
- Improved diode reverse recovery characteristics
- Zener-protected

Application

Switching applications

Description

These devices are made using the SuperMESH3™ Power MOSFET technology that is obtained via improvements applied to STMicroelectronics' SuperMESH™ technology combined with a new optimized vertical structure. The resulting product has an extremely low on resistance, superior dynamic performance and high avalanche capability, making it especially suitable for the most demanding applications.

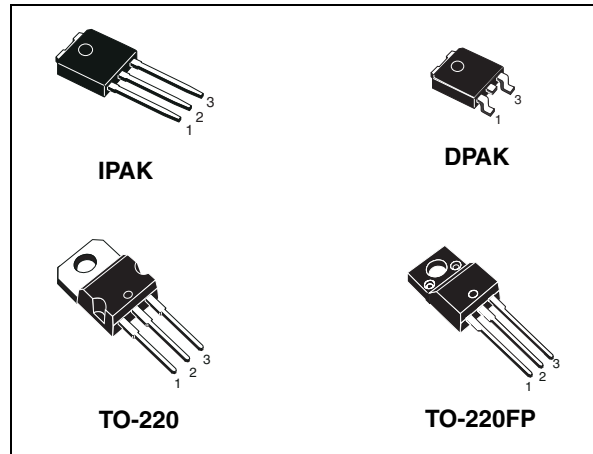

Figure 1. Internal schematic diagram

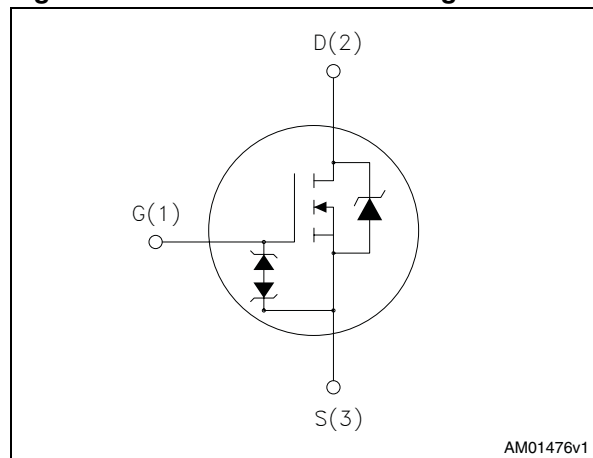

Table 1. Device summary

Order codes	Marking	Package	Packaging
STD3LN62K3	3LN62K3	DPAK	Tape and reel
STF3LN62K3		TO-220FP	Tube
STP3LN62K3		TO-220	
STU3LN62K3		IPAK	

Contents

1	Electrical ratings	3
2	Electrical characteristics	4
2.1	Electrical characteristics (curves)	6
3	Test circuits	9
4	Package mechanical data	10
5	Packaging mechanical data	18
6	Revision history	20

1 Electrical ratings

Table 2. Absolute maximum ratings

Symbol	Parameter	Value			Unit
		TO-220	DPAK IPAK	TO-220FP	
V_{DS}	Drain-source voltage ($V_{GS} = 0$)	620			V
V_{GS}	Gate- source voltage	± 30			V
I_D	Drain current (continuous) at $T_C = 25\text{ }^\circ\text{C}$	2.5		2.5 ⁽¹⁾	A
I_D	Drain current (continuous) at $T_C = 100\text{ }^\circ\text{C}$	1.6		1.6 ⁽¹⁾	A
I_{DM} ⁽²⁾	Drain current (pulsed)	10		10 ⁽¹⁾	A
P_{TOT}	Total dissipation at $T_C = 25\text{ }^\circ\text{C}$	45		20	W
	Derating factor	0.36		0.16	W/°C
$V_{ESD(G-S)}$	Gate source ESD (HBM-C = 100 pF, R = 1.5 kΩ)	2500			V
dv/dt ⁽³⁾	Peak diode recovery voltage slope	12			V/ns
V_{ISO}	Insulation withstand voltage (RMS) from all three leads to external heat sink (t = 1 s; $T_C = 25\text{ }^\circ\text{C}$)	2500			V
T_{stg}	Storage temperature	-55 to 150			°C
T_j	Max. operating junction temperature	150			°C

- Limited by package
- Pulse width limited by safe operating area
- $I_{SD} \leq 2.5\text{ A}$, $di/dt \leq 400\text{ A}/\mu\text{s}$, peak $V_{DS} < V_{(BR)DSS}$, $V_{DD} = 80\% V_{(BR)DSS}$

Table 3. Thermal data

Symbol	Parameter	TO-220	DPAK IPAK	TO-220FP	Unit
$R_{thj-case}$	Thermal resistance junction-case max	2.78		6.25	°C/W
$R_{thj-pcb}$	Thermal resistance junction-pcb max		50		°C/W
$R_{thj-amb}$	Thermal resistance junction-amb max	62.5		62.5	°C/W
T_l	Maximum lead temperature for soldering purpose	300		300	°C

Table 4. Avalanche characteristics

Symbol	Parameter	Max value	Unit
I_{AR}	Avalanche current, repetitive or not-repetitive (pulse width limited by T_j max)	2.5	A
E_{AS}	Single pulse avalanche energy (starting $T_j = 25\text{ }^\circ\text{C}$, $I_D = I_{AR}$, $V_{DD} = 50\text{ V}$)	90	mJ

2 Electrical characteristics

($T_C = 25\text{ °C}$ unless otherwise specified)

Table 5. On /off states

Symbol	Parameter	Test conditions	Min.	Typ.	Max.	Unit
$V_{(BR)DSS}$	Drain-source breakdown voltage	$I_D = 1\text{ mA}$, $V_{GS} = 0$	620			V
I_{DSS}	Zero gate voltage drain current ($V_{GS} = 0$)	$V_{DS} = \text{Max rating}$ $V_{DS} = \text{Max rating}$, $T_C = 125\text{ °C}$			1 50	μA μA
I_{GSS}	Gate-body leakage current ($V_{DS} = 0$)	$V_{GS} = \pm 20\text{ V}$			± 10	μA
$V_{GS(th)}$	Gate threshold voltage	$V_{DS} = V_{GS}$, $I_D = 50\text{ }\mu\text{A}$	3	3.75	4.5	V
$R_{DS(on)}$	Static drain-source on resistance	$V_{GS} = 10\text{ V}$, $I_D = 1.25\text{ A}$		2.5	3	Ω

Table 6. Dynamic

Symbol	Parameter	Test conditions	Min.	Typ.	Max.	Unit
C_{iss}	Input capacitance	$V_{DS} = 50\text{ V}$, $f = 1\text{ MHz}$, $V_{GS} = 0$	-	386	-	pF
C_{oss}	Output capacitance			30		pF
C_{rss}	Reverse transfer capacitance			5		pF
$C_{o(tr)}^{(1)}$	Eq. capacitance time related	$V_{GS} = 0$, $V_{DS} = 0\text{ to }496\text{ V}$	-	20	-	pF
$C_{o(er)}^{(2)}$	Eq. capacitance energy related			28		pF
R_G	Intrinsic gate resistance	$f = 1\text{ MHz}$ open drain	-	7	-	Ω
Q_g	Total gate charge	$V_{DD} = 496\text{ V}$, $I_D = 2.5\text{ A}$, $V_{GS} = 10\text{ V}$ (see Figure 20)	-	17	-	nC
Q_{gs}	Gate-source charge			2.7		nC
Q_{gd}	Gate-drain charge			10.7		nC

1. $C_{oss\text{ eq.}}$ time related is defined as a constant equivalent capacitance giving the same charging time as C_{oss} when V_{DS} increases from 0 to 80% V_{DSS}

2. $C_{oss\text{ eq.}}$ energy related is defined as a constant equivalent capacitance giving the same stored energy as C_{oss} when V_{DS} increases from 0 to 80% V_{DSS}

Table 7. Switching times

Symbol	Parameter	Test conditions	Min.	Typ.	Max.	Unit
$t_{d(on)}$	Turn-on delay time	$V_{DD} = 310\text{ V}$, $I_D = 1.25\text{ A}$, $R_G = 4.7\ \Omega$, $V_{GS} = 10\text{ V}$ (see Figure 19)		9		ns
t_r	Rise time			7		ns
$t_{d(off)}$	Turn-off-delay time			30	-	ns
t_f	Fall time			27		ns

Table 8. Source drain diode

Symbol	Parameter	Test conditions	Min.	Typ.	Max.	Unit
I_{SD}	Source-drain current		-		2.5	A
$I_{SDM}^{(1)}$	Source-drain current (pulsed)				10	A
$V_{SD}^{(2)}$	Forward on voltage	$I_{SD} = 2.5\text{ A}$, $V_{GS} = 0$	-		1.5	V
t_{rr}	Reverse recovery time	$I_{SD} = 2.5\text{ A}$, $di/dt = 100\text{ A}/\mu\text{s}$ $V_{DD} = 60\text{ V}$ (see Figure 24)	-	240		ns
Q_{rr}	Reverse recovery charge			1200		nC
I_{RRM}	Reverse recovery current			10		A
t_{rr}	Reverse recovery time	$I_{SD} = 2.5\text{ A}$, $di/dt = 100\text{ A}/\mu\text{s}$ $V_{DD} = 60\text{ V}$, $T_j = 150\text{ }^\circ\text{C}$ (see Figure 24)	-	265		ns
Q_{rr}	Reverse recovery charge			1400		nC
I_{RRM}	Reverse recovery current			11		A

1. Pulse width limited by safe operating area.
2. Pulsed: Pulse duration = 300 μs , duty cycle 1.5%

Table 9. Gate-source Zener diode

Symbol	Parameter	Test conditions	Min.	Typ.	Max.	Unit
$BV_{GSO}^{(1)}$	Gate-source breakdown voltage	$I_{gs} = \pm 1\text{ mA}$ (open drain)	30	-		V

1. The built-in back-to-back Zener diodes have specifically been designed to enhance not only the device's ESD capability, but also to make them safely absorb possible voltage transients that may occasionally be applied from gate to source. In this respect the Zener voltage is appropriate to achieve an efficient and cost-effective intervention to protect the device's integrity. These integrated Zener diodes thus avoid the usage of external components.

2.1 Electrical characteristics (curves)

Figure 2. Safe operating area for TO-220

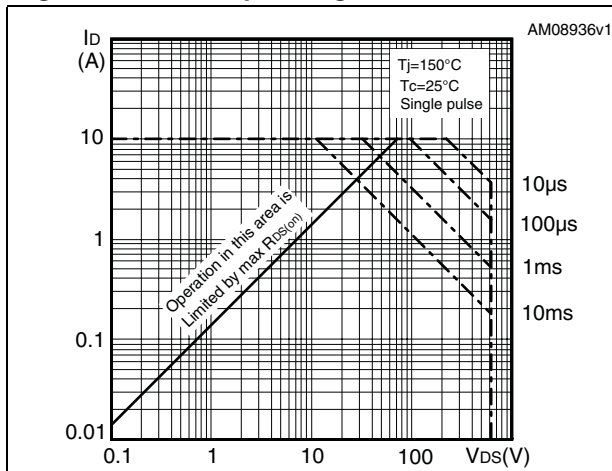

Figure 3. Thermal impedance for TO-220

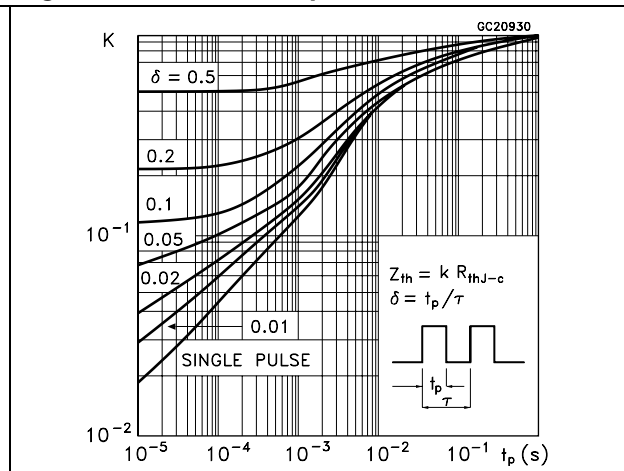

Figure 4. Safe operating area for TO-220FP

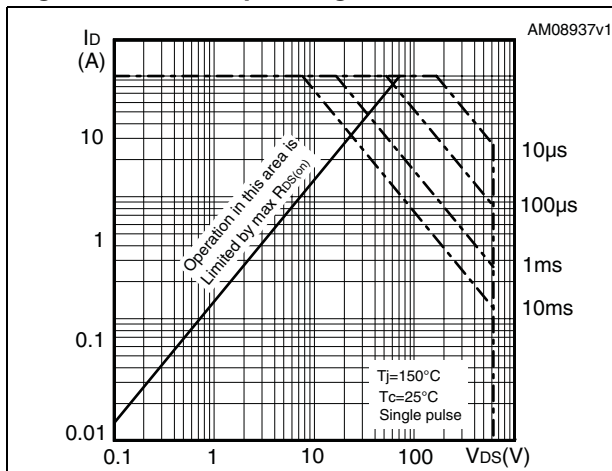

Figure 5. Thermal impedance for TO-220FP

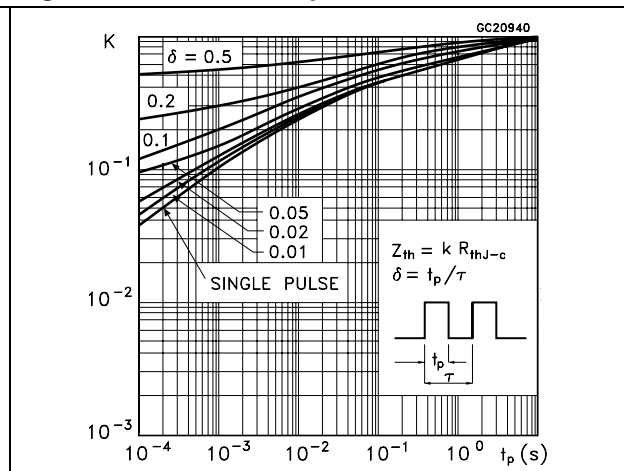

Figure 6. Safe operating area for DPAK, IPAK

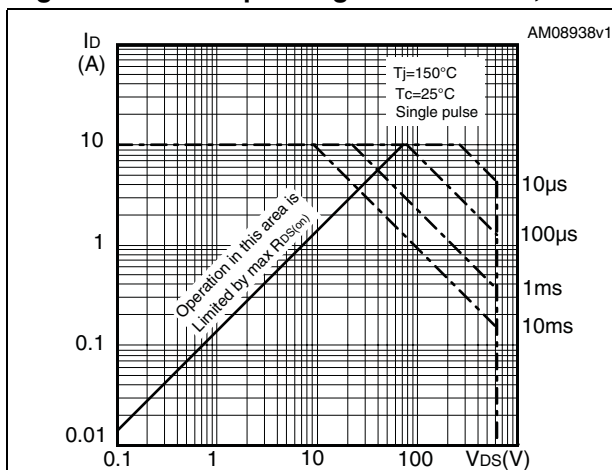

Figure 7. Thermal impedance for DPAK, IPAK

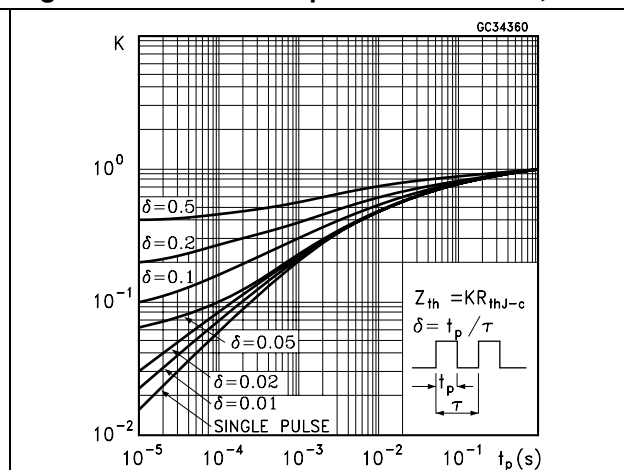

Figure 8. Output characteristics

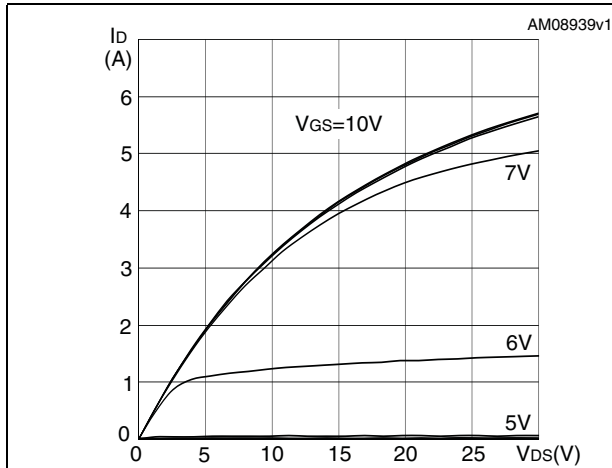

Figure 9. Transfer characteristics

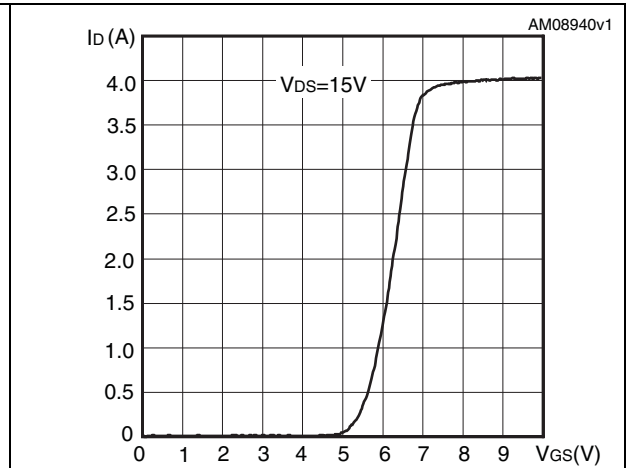

Figure 10. Gate charge vs gate-source voltage

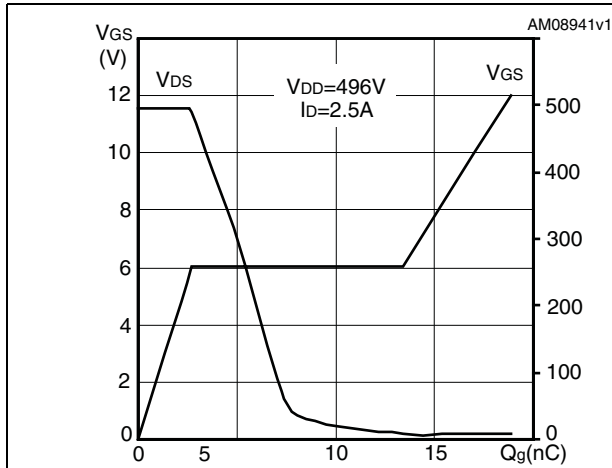

Figure 11. Static drain-source on resistance

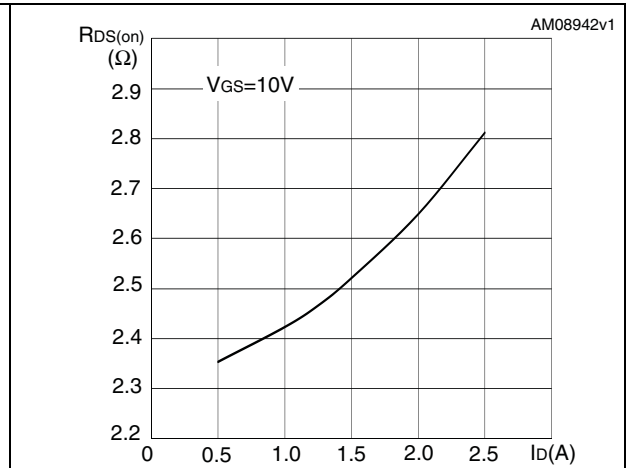

Figure 12. Capacitance variations

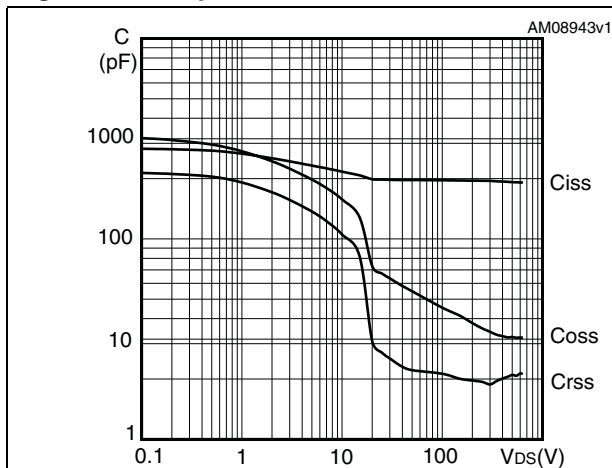

Figure 13. Output capacitance stored energy

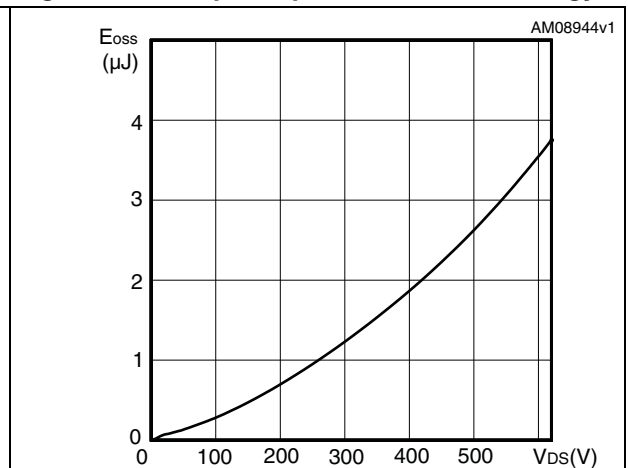

Figure 14. Normalized gate threshold voltage vs temperature

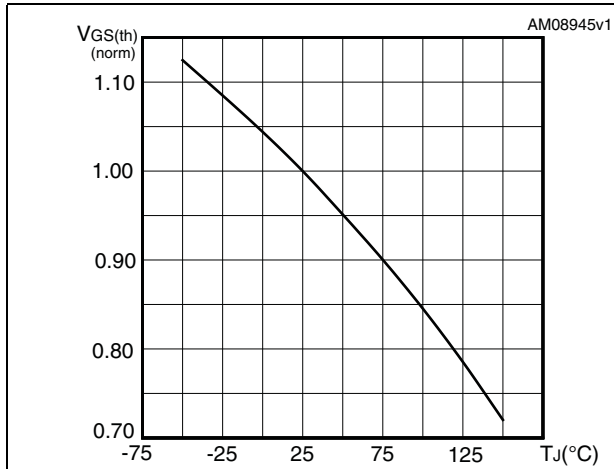

Figure 15. Normalized on resistance vs temperature

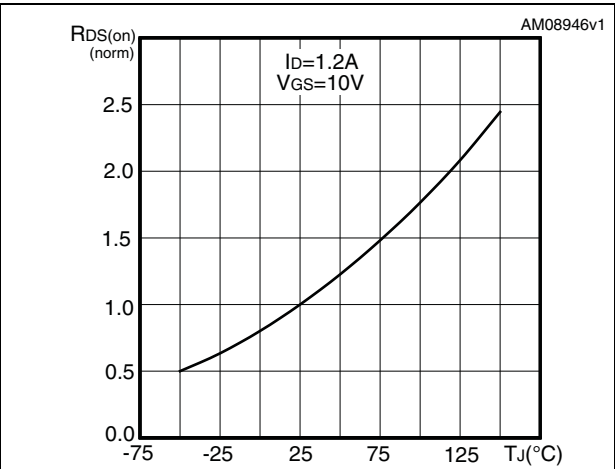

Figure 16. Normalized BV_{DSS} vs temperature

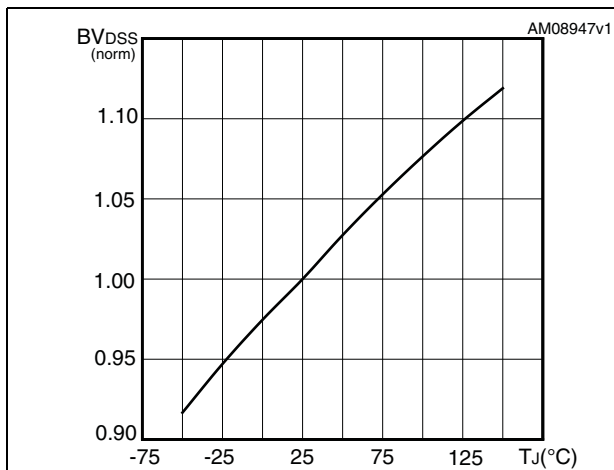

Figure 17. Source-drain diode forward characteristics

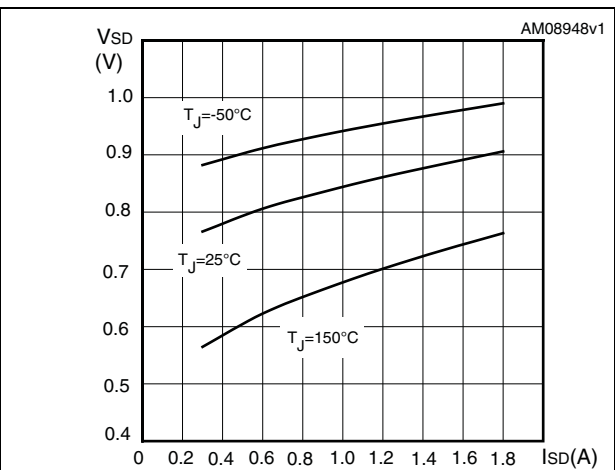
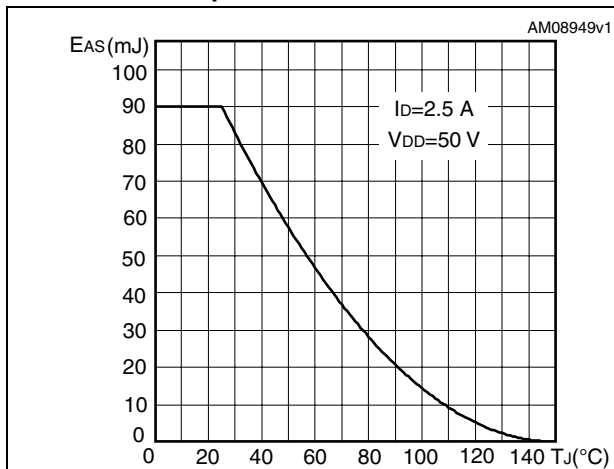

Figure 18. Maximum avalanche energy vs temperature



3 Test circuits

Figure 19. Switching times test circuit for resistive load



AM01468v1

Figure 20. Gate charge test circuit



AM01469v1

Figure 21. Test circuit for inductive load switching and diode recovery times



AM01470v1

Figure 22. Unclamped Inductive load test circuit



AM01471v1

Figure 23. Unclamped inductive waveform

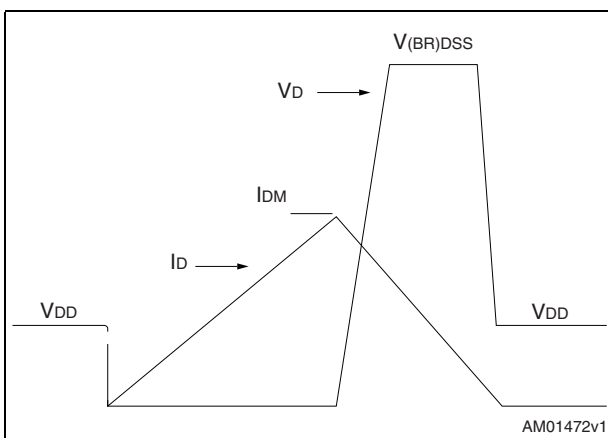

AM01472v1

Figure 24. Switching time waveform

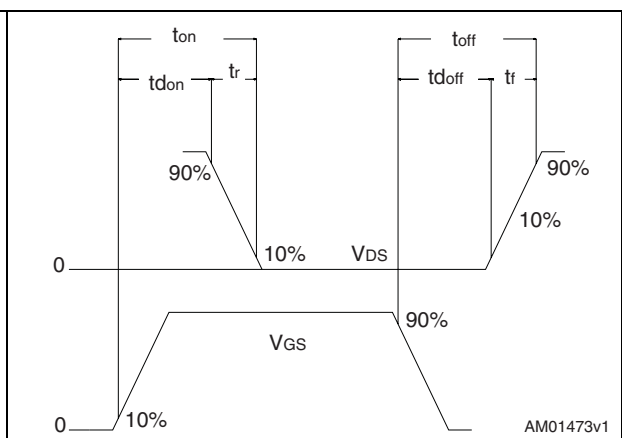

AM01473v1

4 Package mechanical data

In order to meet environmental requirements, ST offers these devices in different grades of ECOPACK[®] packages, depending on their level of environmental compliance. ECOPACK[®] specifications, grade definitions and product status are available at: www.st.com. ECOPACK is an ST trademark.

Table 10. DPAK (TO-252) mechanical data

Dim.	mm		
	Min.	Typ.	Max.
A	2.20		2.40
A1	0.90		1.10
A2	0.03		0.23
b	0.64		0.90
b4	5.20		5.40
c	0.45		0.60
c2	0.48		0.60
D	6.00		6.20
D1		5.10	
E	6.40		6.60
E1		4.70	
e		2.28	
e1	4.40		4.60
H	9.35		10.10
L	1		
L1		2.80	
L2		0.80	
L4	0.60		1
R		0.20	
V2	0°		8°

Figure 25. DPAK (TO-252) drawing

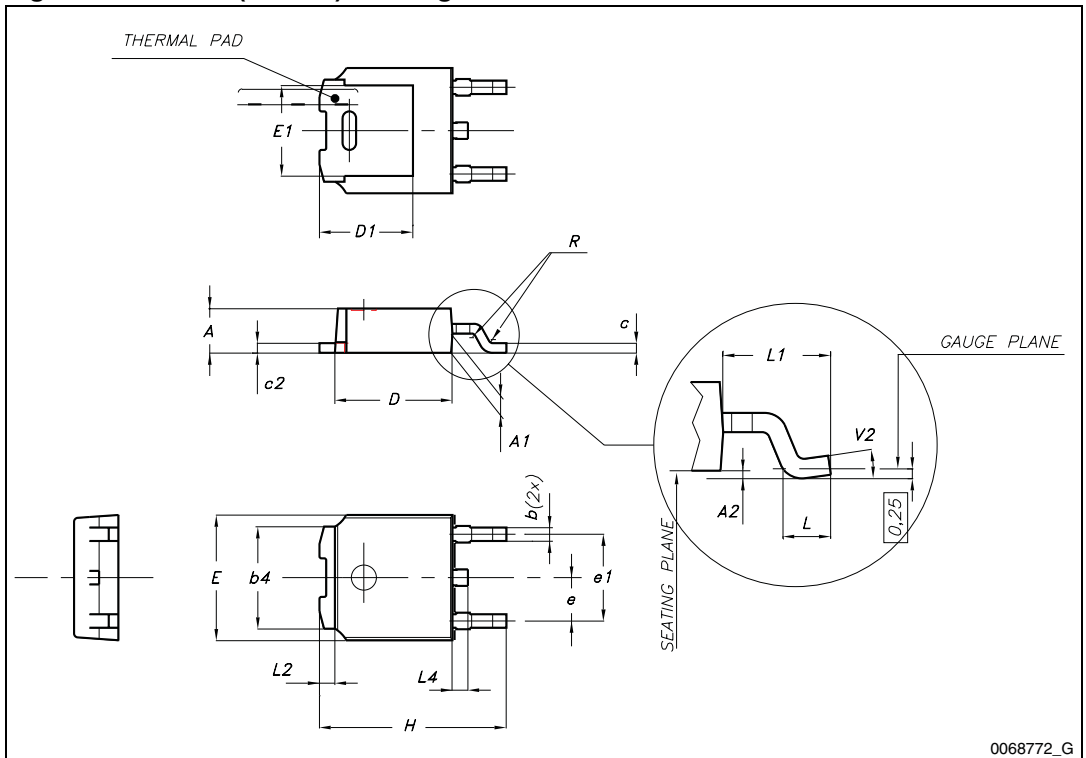

Table 11. IPAK (TO-251) mechanical data

DIM.	mm.		
	min.	typ	max.
A	2.20		2.40
A1	0.90		1.10
b	0.64		0.90
b2			0.95
b4	5.20		5.40
B5		0.3	
c	0.45		0.60
c2	0.48		0.60
D	6.00		6.20
E	6.40		6.60
e		2.28	
e1	4.40		4.60
H		16.10	
L	9.00		9.40
L1	0.80		1.20
L2		0.80	1.00
V1		10°	

Figure 26. IPAK (TO-251) drawing

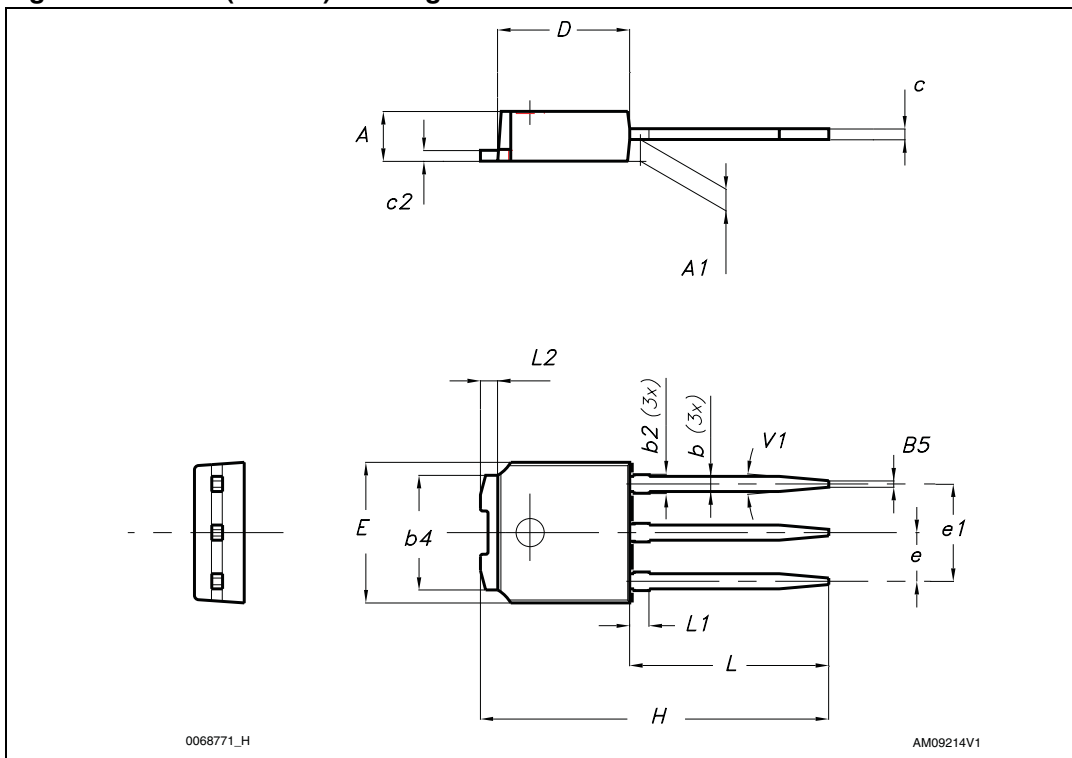
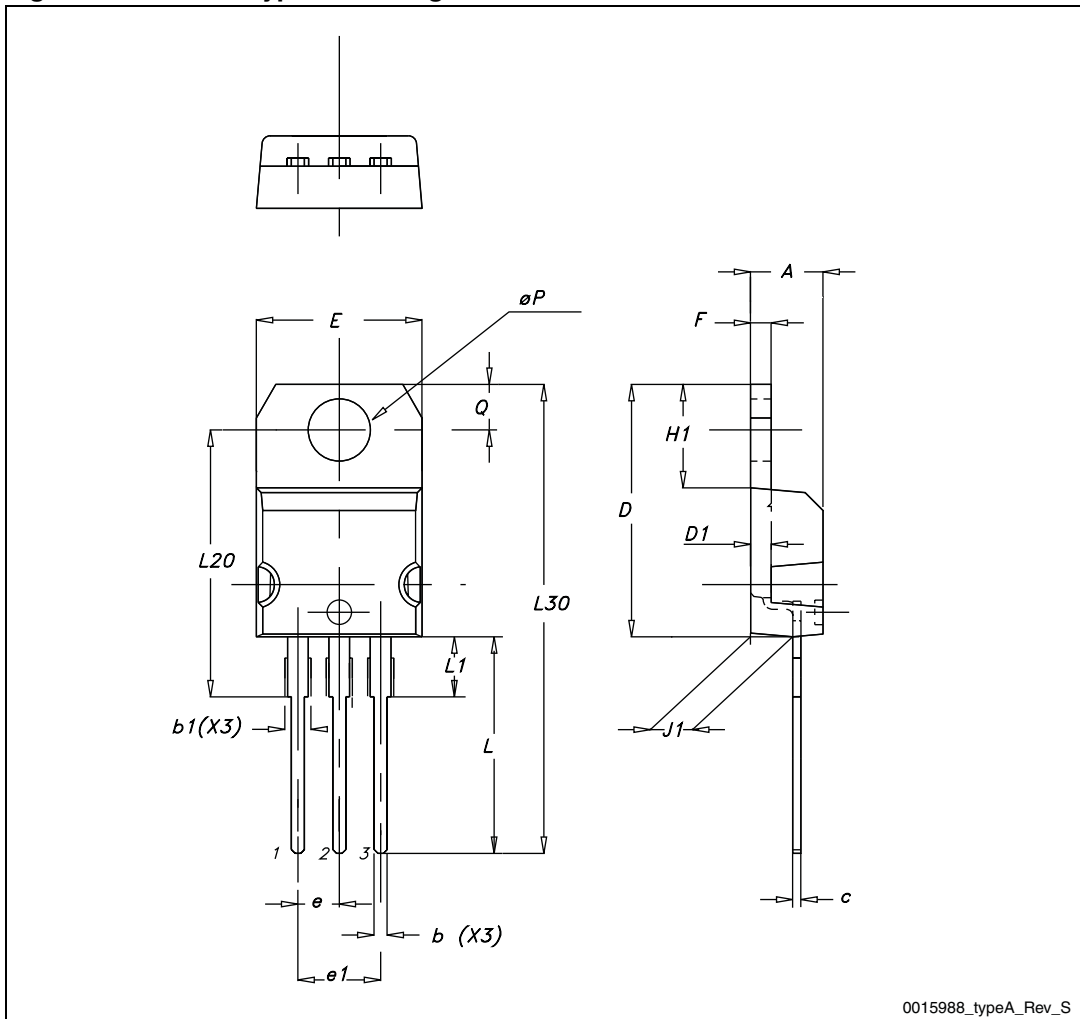

Table 12. TO-220 type A mechanical data

Dim.	mm		
	Min.	Typ.	Max.
A	4.40		4.60
b	0.61		0.88
b1	1.14		1.70
c	0.48		0.70
D	15.25		15.75
D1		1.27	
E	10		10.40
e	2.40		2.70
e1	4.95		5.15
F	1.23		1.32
H1	6.20		6.60
J1	2.40		2.72
L	13		14
L1	3.50		3.93
L20		16.40	
L30		28.90	
ØP	3.75		3.85
Q	2.65		2.95

Figure 27. TO-220 type A drawing



0015988_typeA_Rev_S

Table 13. TO-220FP mechanical data

Dim.	mm		
	Min.	Typ.	Max.
A	4.4		4.6
B	2.5		2.7
D	2.5		2.75
E	0.45		0.7
F	0.75		1
F1	1.15		1.70
F2	1.15		1.70
G	4.95		5.2
G1	2.4		2.7
H	10		10.4
L2		16	
L3	28.6		30.6
L4	9.8		10.6
L5	2.9		3.6
L6	15.9		16.4
L7	9		9.3
Dia	3		3.2

Figure 28. TO-220FP drawing

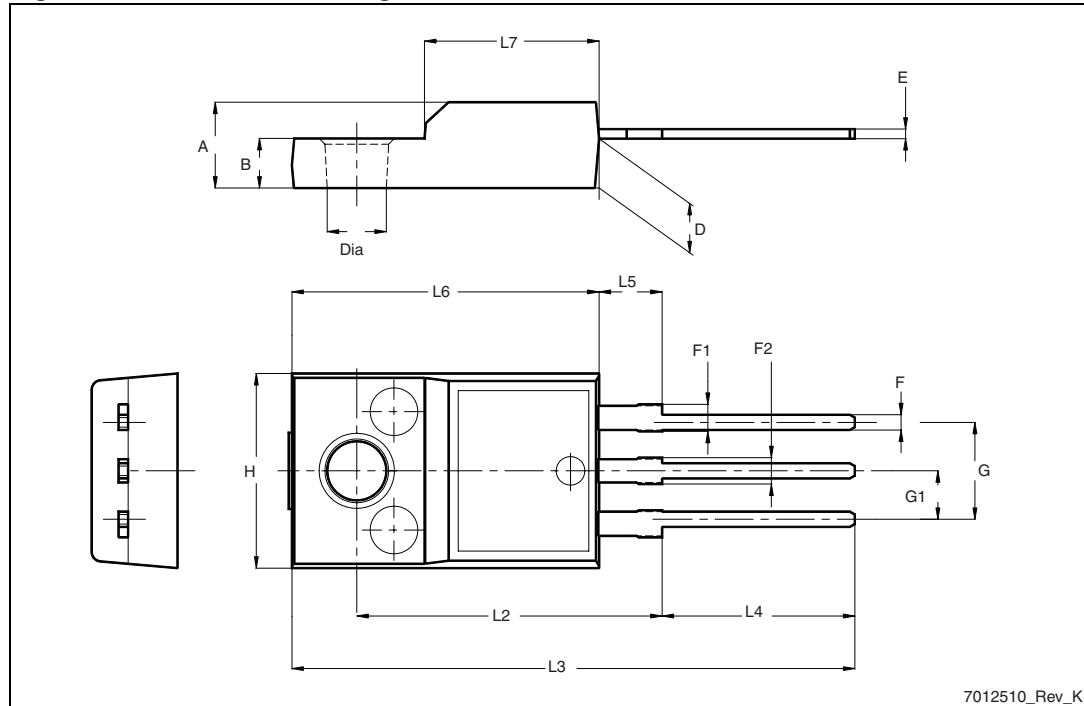

7012510_Rev_K

5 Packaging mechanical data

Table 14. DPAK (TO-252) tape and reel mechanical data

Tape			Reel		
Dim.	mm		Dim.	mm	
	Min.	Max.		Min.	Max.
A0	6.8	7	A		330
B0	10.4	10.6	B	1.5	
B1		12.1	C	12.8	13.2
D	1.5	1.6	D	20.2	
D1	1.5		G	16.4	18.4
E	1.65	1.85	N	50	
F	7.4	7.6	T		22.4
K0	2.55	2.75			
P0	3.9	4.1	Base qty.	2500	
P1	7.9	8.1	Bulk qty.	2500	
P2	1.9	2.1			
R	40				
T	0.25	0.35			
W	15.7	16.3			

Figure 29. DPAK footprint^(a)

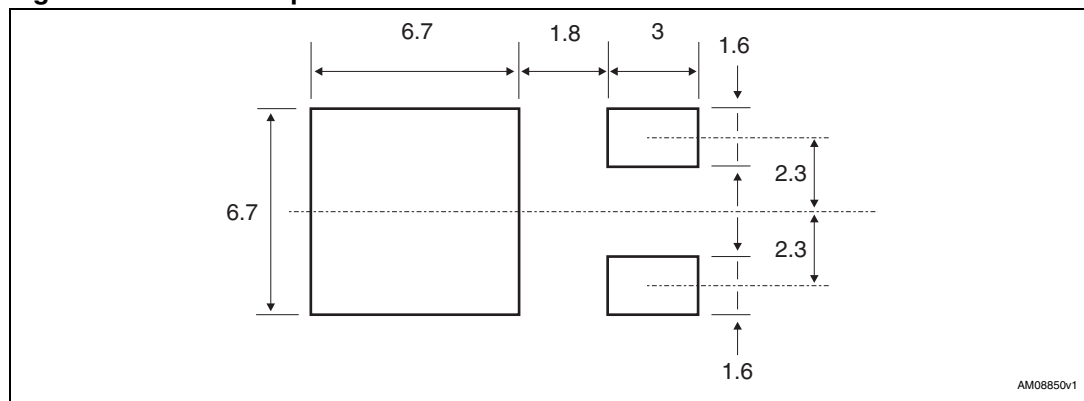

a. All dimension are in millimeters

Figure 30. Tape for DPAK (TO-252)

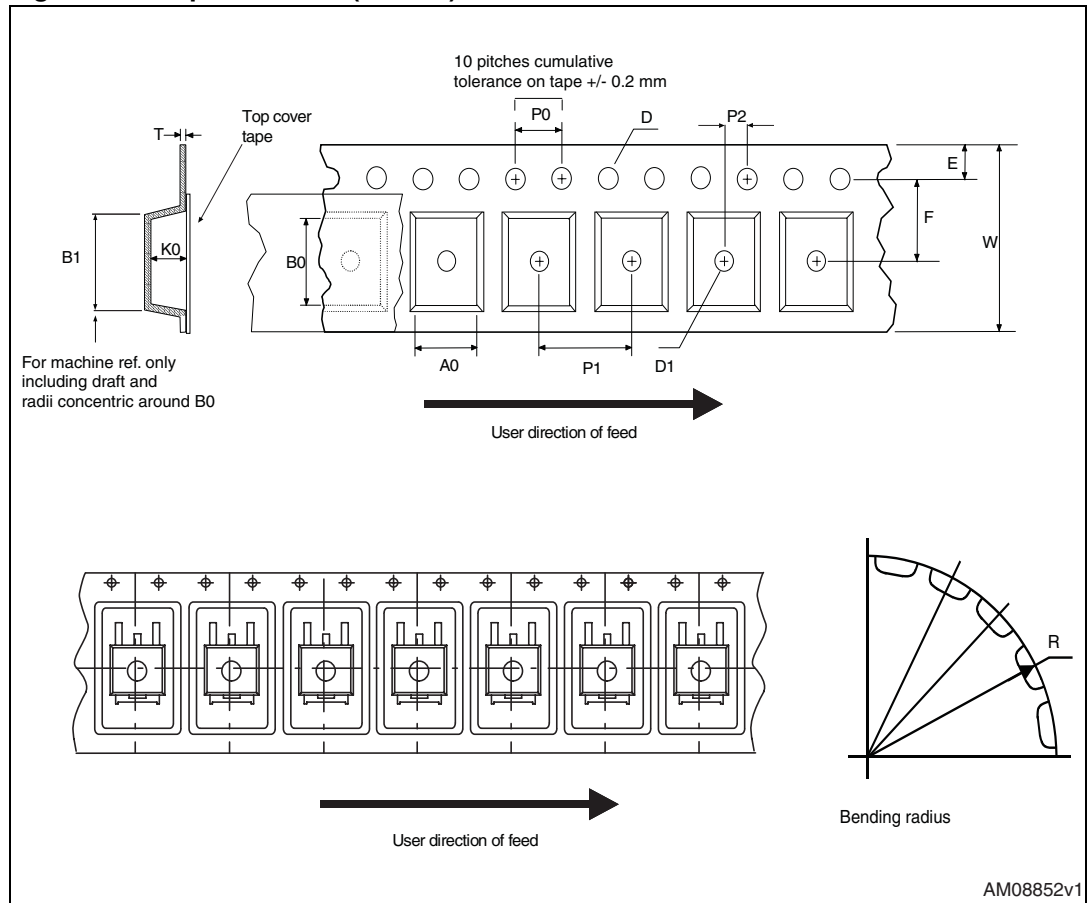
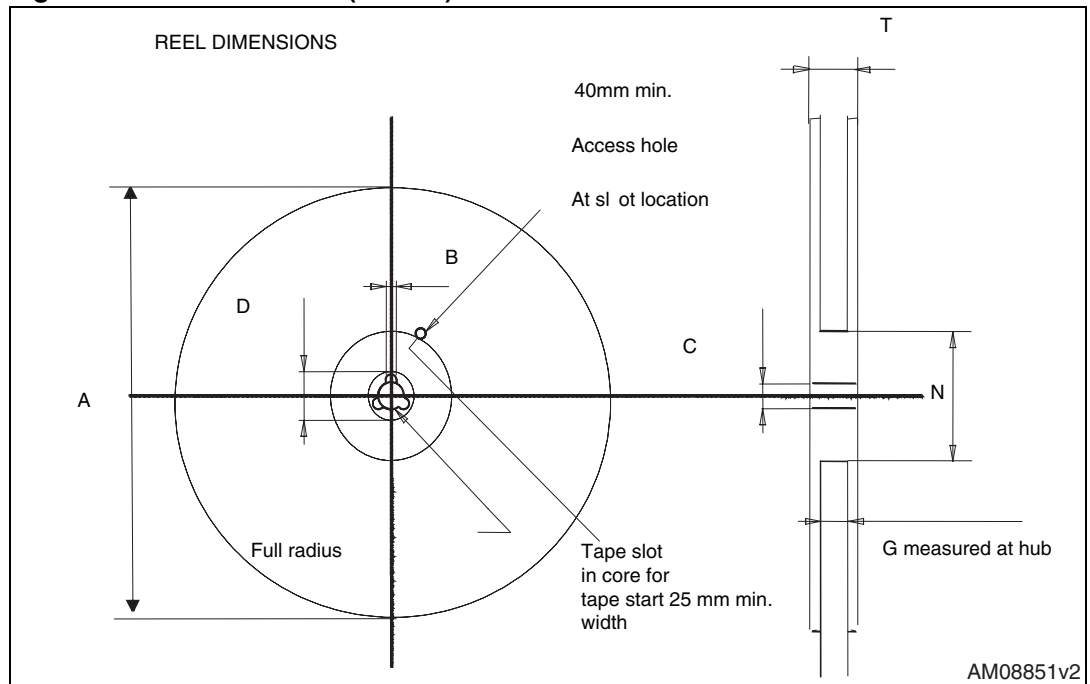

Figure 31. Reel for DPAK (TO-252)



6 Revision history

Table 15. Document revision history

Date	Revision	Changes
04-Feb-2011	1	First release.

Please Read Carefully:

Information in this document is provided solely in connection with ST products. STMicroelectronics NV and its subsidiaries ("ST") reserve the right to make changes, corrections, modifications or improvements, to this document, and the products and services described herein at any time, without notice.

All ST products are sold pursuant to ST's terms and conditions of sale.

Purchasers are solely responsible for the choice, selection and use of the ST products and services described herein, and ST assumes no liability whatsoever relating to the choice, selection or use of the ST products and services described herein.

No license, express or implied, by estoppel or otherwise, to any intellectual property rights is granted under this document. If any part of this document refers to any third party products or services it shall not be deemed a license grant by ST for the use of such third party products or services, or any intellectual property contained therein or considered as a warranty covering the use in any manner whatsoever of such third party products or services or any intellectual property contained therein.

UNLESS OTHERWISE SET FORTH IN ST'S TERMS AND CONDITIONS OF SALE ST DISCLAIMS ANY EXPRESS OR IMPLIED WARRANTY WITH RESPECT TO THE USE AND/OR SALE OF ST PRODUCTS INCLUDING WITHOUT LIMITATION IMPLIED WARRANTIES OF MERCHANTABILITY, FITNESS FOR A PARTICULAR PURPOSE (AND THEIR EQUIVALENTS UNDER THE LAWS OF ANY JURISDICTION), OR INFRINGEMENT OF ANY PATENT, COPYRIGHT OR OTHER INTELLECTUAL PROPERTY RIGHT.

UNLESS EXPRESSLY APPROVED IN WRITING BY AN AUTHORIZED ST REPRESENTATIVE, ST PRODUCTS ARE NOT RECOMMENDED, AUTHORIZED OR WARRANTED FOR USE IN MILITARY, AIR CRAFT, SPACE, LIFE SAVING, OR LIFE SUSTAINING APPLICATIONS, NOR IN PRODUCTS OR SYSTEMS WHERE FAILURE OR MALFUNCTION MAY RESULT IN PERSONAL INJURY, DEATH, OR SEVERE PROPERTY OR ENVIRONMENTAL DAMAGE. ST PRODUCTS WHICH ARE NOT SPECIFIED AS "AUTOMOTIVE GRADE" MAY ONLY BE USED IN AUTOMOTIVE APPLICATIONS AT USER'S OWN RISK.

Resale of ST products with provisions different from the statements and/or technical features set forth in this document shall immediately void any warranty granted by ST for the ST product or service described herein and shall not create or extend in any manner whatsoever, any liability of ST.

ST and the ST logo are trademarks or registered trademarks of ST in various countries.

Information in this document supersedes and replaces all information previously supplied.

The ST logo is a registered trademark of STMicroelectronics. All other names are the property of their respective owners.

© 2011 STMicroelectronics - All rights reserved

STMicroelectronics group of companies

Australia - Belgium - Brazil - Canada - China - Czech Republic - Finland - France - Germany - Hong Kong - India - Israel - Italy - Japan - Malaysia - Malta - Morocco - Philippines - Singapore - Spain - Sweden - Switzerland - United Kingdom - United States of America

www.st.com



X-ON Electronics

Largest Supplier of Electrical and Electronic Components

Click to view similar products for [MOSFET](#) category:

Click to view products by [STMicroelectronics](#) manufacturer:

Other Similar products are found below :

[614233C](#) [648584F](#) [IRFD120](#) [JANTX2N5237](#) [2N7000](#) [FCA20N60_F109](#) [FDZ595PZ](#) [2SK2545\(Q,T\)](#) [405094E](#) [423220D](#)
[TPCC8103,L1Q\(CM](#) [MIC4420CM-TR](#) [VN1206L](#) [614234A](#) [715780A](#) [NTNS3166NZT5G](#) [SSM6J414TU,LF\(T](#) [751625C](#)
[IPS70R2K0CEAKMA1](#) [BUK954R8-60E](#) [DMN3404LQ-7](#) [NTE6400](#) [SQJ402EP-T1-GE3](#) [2SK2614\(TE16L1,Q\)](#) [2N7002KW-FAI](#)
[DMN1017UCP3-7](#) [EFC2J004NUZTDG](#) [ECH8691-TL-W](#) [FCAB21350L1](#) [P85W28HP2F-7071](#) [DMN1053UCP4-7](#) [NTE221](#) [NTE2384](#)
[NTE2903](#) [NTE2941](#) [NTE2945](#) [NTE2946](#) [NTE2960](#) [NTE2967](#) [NTE2969](#) [NTE2976](#) [NTE455](#) [NTE6400A](#) [NTE2910](#) [NTE2916](#) [NTE2956](#)
[NTE2911](#) [US6M2GTR](#) [TK10A80W,S4X\(S](#) [SSM6P69NU,LF](#)