

N-channel 600 V, 36 mΩ typ., 62 A, MDmesh DM6 Power MOSFETs in TO-247 and TO-247 long leads packages

Features

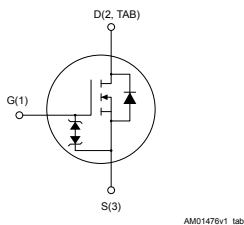
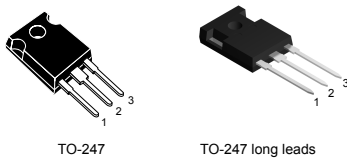

Order code	V _{DS}	R _{DS(on)} max.	I _D
STW70N60DM6	600 V	42 mΩ	62 A
STWA70N60DM6			

- Fast-recovery body diode
- Lower R_{DS(on)} per area vs previous generation
- Low gate charge, input capacitance and resistance
- 100% avalanche tested
- Extremely high dv/dt ruggedness
- Zener-protected

Applications

- Switching applications

Description

These high-voltage N-channel Power MOSFETs are part of the MDmesh DM6 fast-recovery diode series. Compared with the previous MDmesh fast generation, DM6 combines very low recovery charge (Q_{rr}), recovery time (t_{rr}) and excellent improvement in R_{DS(on)} per area with one of the most effective switching behaviors available in the market for the most demanding high-efficiency bridge topologies and ZVS phase-shift converters.

Product status links

[STW70N60DM6](#)

[STWA70N60DM6](#)

Product summary

STW70N60DM6

Order code	STW70N60DM6
Marking	70N60DM6
Package	TO-247
Packing	Tube

STWA70N60DM6

Order code	STWA70N60DM6
Marking	70N60DM6
Package	TO-247 long leads
Packing	Tube

1 Electrical ratings

Table 1. Absolute maximum ratings

Symbol	Parameter	Value	Unit
V_{GS}	Gate-source voltage	± 25	V
I_D	Drain current (continuous) at $T_C = 25\text{ }^\circ\text{C}$	62	A
I_D	Drain current (continuous) at $T_C = 100\text{ }^\circ\text{C}$	39	A
$I_D^{(1)}$	Drain current (pulsed)	220	A
P_{TOT}	Total power dissipation at $T_C = 25\text{ }^\circ\text{C}$	390	W
$dv/dt^{(2)}$	Peak diode recovery voltage slope	100	V/ns
$di/dt^{(2)}$	Peak diode recovery current slope	1000	A/ μ s
$dv/dt^{(3)}$	MOSFET dv/dt ruggedness	100	V/ns
T_{STG}	Storage temperature range	-55 to 150	$^\circ\text{C}$
T_J	Operating junction temperature range		$^\circ\text{C}$

1. Pulse width is limited by safe operating area.
2. $I_{SD} \leq 25\text{ A}$, $V_{DS(peak)} < V_{(BR)DSS}$, $V_{DD} = 400\text{ V}$
3. $V_{DS} \leq 480\text{ V}$

Table 2. Thermal data

Symbol	Parameter	Value	Unit
$R_{thj-case}$	Thermal resistance junction-case	0.32	$^\circ\text{C/W}$
$R_{thj-amb}$	Thermal resistance junction-ambient	50	$^\circ\text{C/W}$

Table 3. Avalanche characteristics

Symbol	Parameter	Value	Unit
I_{AR}	Avalanche current, repetitive or not repetitive (pulse width limited by T_{jmax})	7	A
E_{AS}	Single pulse avalanche energy (starting $T_j = 25\text{ }^\circ\text{C}$, $I_D = I_{AR}$, $V_{DD} = 50\text{ V}$)	1850	mJ

2 Electrical characteristics

$T_C = 25\text{ }^\circ\text{C}$ unless otherwise specified

Table 4. On/off states

Symbol	Parameter	Test conditions	Min.	Typ.	Max.	Unit
$V_{(BR)DSS}$	Drain-source breakdown voltage	$V_{GS} = 0\text{ V}$, $I_D = 1\text{ mA}$	600			V
I_{DSS}	Zero gate voltage drain current	$V_{GS} = 0\text{ V}$, $V_{DS} = 600\text{ V}$			5	μA
		$V_{GS} = 0\text{ V}$, $V_{DS} = 600\text{ V}$, $T_J = 125\text{ }^\circ\text{C}^{(1)}$			100	
I_{GSS}	Gate-body leakage current	$V_{DS} = 0\text{ V}$, $V_{GS} = \pm 25\text{ V}$			± 5	μA
$V_{GS(th)}$	Gate threshold voltage	$V_{DS} = V_{GS}$, $I_D = 250\text{ }\mu\text{A}$	3.25	4	4.75	V
$R_{DS(on)}$	Static drain-source on-resistance	$V_{GS} = 10\text{ V}$, $I_D = 31\text{ A}$		36	42	m Ω

1. Defined by design, not subject to production test.

Table 5. Dynamic characteristics

Symbol	Parameter	Test conditions	Min.	Typ.	Max.	Unit
C_{iss}	Input capacitance	$V_{DS} = 100\text{ V}$, $f = 1\text{ MHz}$, $V_{GS} = 0\text{ V}$	-	4360	-	μF
C_{oss}	Output capacitance		-	235	-	
C_{riss}	Reverse transfer capacitance		-	13	-	
$C_{oss\text{ eq}}^{(1)}$	Equivalent output capacitance	$V_{DS} = 0\text{ to }480\text{ V}$, $V_{GS} = 0\text{ V}$	-	286	-	
R_G	Intrinsic gate resistance	$f = 1\text{ MHz}$, $I_D = 0\text{ A}$	-	1.5	-	Ω
Q_g	Total gate charge	$V_{DD} = 480\text{ V}$, $I_D = 62\text{ A}$, $V_{GS} = 0\text{ to }10\text{ V}$ (see Figure 14. Test circuit for gate charge behavior)	-	99	-	nC
Q_{gs}	Gate-source charge		-	28	-	
Q_{gd}	Gate-drain charge		-	44	-	

1. $C_{oss\text{ eq}}$ is defined as a constant equivalent capacitance giving the same charging time as C_{oss} when V_{DS} increases from 0 to 80% V_{DSS}

Table 6. Switching times

Symbol	Parameter	Test conditions	Min.	Typ.	Max.	Unit
$t_{d(on)}$	Turn-on delay time	$V_{DD} = 300\text{ V}$, $I_D = 31\text{ A}$, $R_G = 4.7\text{ }\Omega$, $V_{GS} = 10\text{ V}$ (see Figure 13. Test circuit for resistive load switching times and Figure 18. Switching time waveform)	-	28	-	ns
t_r	Rise time		-	49	-	ns
$t_{d(off)}$	Turn-off delay time		-	96	-	ns
t_f	Fall time		-	12	-	ns

Table 7. Source drain diode

Symbol	Parameter	Test conditions	Min.	Typ.	Max.	Unit
I_{SD}	Source-drain current		-		62	A
$I_{SDM}^{(1)}$	Source-drain current (pulsed)		-		220	A
$V_{SD}^{(2)}$	Forward on voltage	$V_{GS} = 0\text{ V}$, $I_{SD} = 62\text{ A}$	-		1.6	V
t_{rr}	Reverse recovery time	$I_{SD} = 62\text{ A}$, $di/dt = 100\text{ A}/\mu\text{s}$, $V_{DD} = 60\text{ V}$	-	138	-	ns
Q_{rr}	Reverse recovery charge		-	0.69	-	μC
I_{RRM}	Reverse recovery current	(see Figure 15. Test circuit for inductive load switching and diode recovery times)	-	10	-	A
t_{rr}	Reverse recovery time	$I_{SD} = 62\text{ A}$, $di/dt = 100\text{ A}/\mu\text{s}$, $V_{DD} = 60\text{ V}$, $T_J = 150\text{ }^\circ\text{C}$	-	340	-	ns
Q_{rr}	Reverse recovery charge		-	4.6	-	μC
I_{RRM}	Reverse recovery current		(see Figure 15. Test circuit for inductive load switching and diode recovery times)	-	27	-

1. Pulse width is limited by safe operating area
2. Pulsed: pulse duration = 300 μs , duty cycle 1.5%

2.1 Electrical characteristics (curves)

Figure 1. Safe operating area

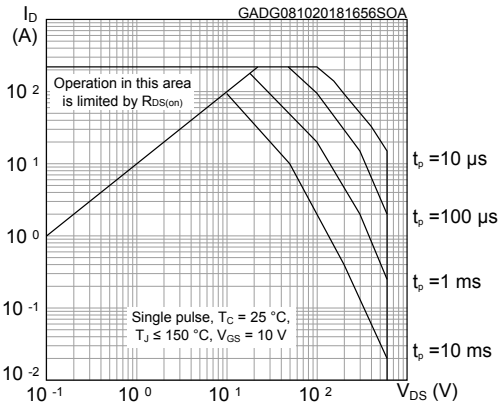

Figure 2. Thermal impedance

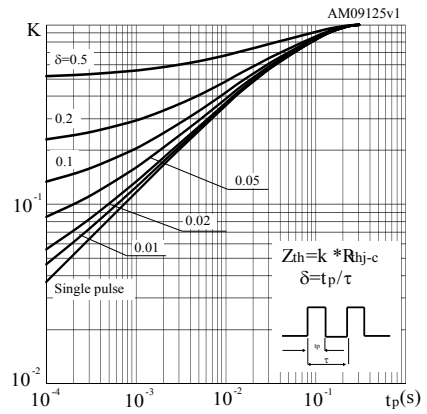

Figure 3. Output characteristics

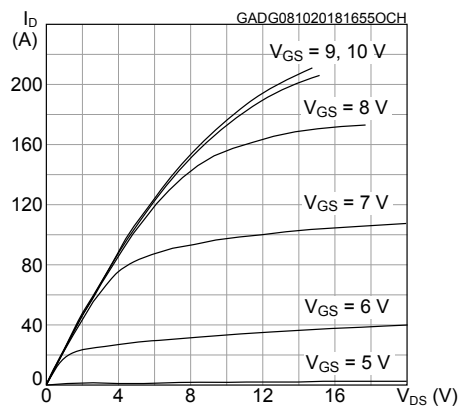

Figure 4. Transfer characteristics

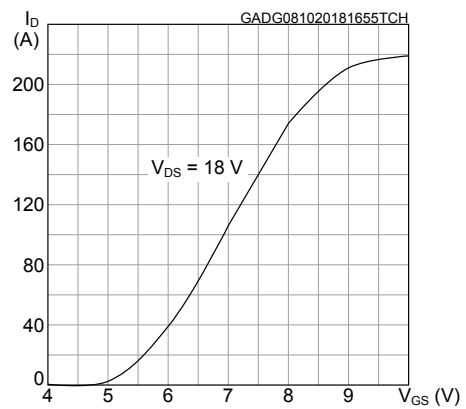

Figure 5. Gate charge vs gate-source voltage

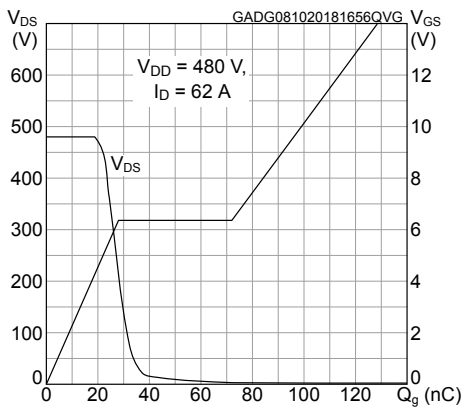

Figure 6. Static drain-source on-resistance

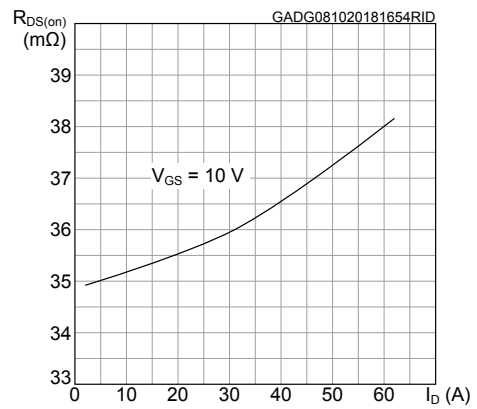
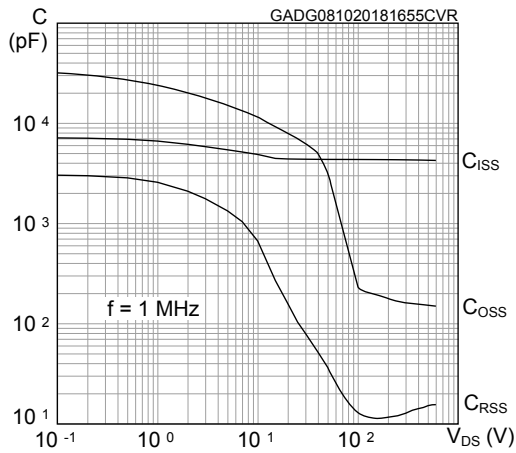
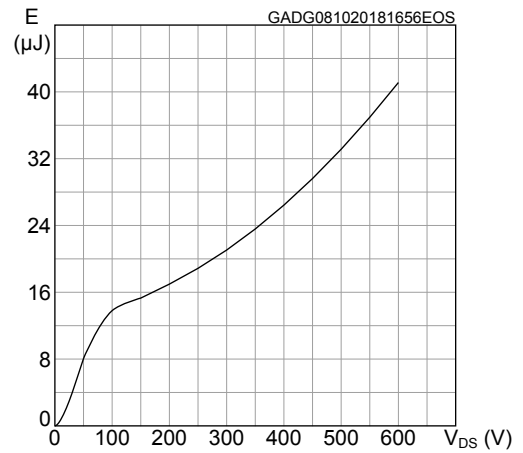
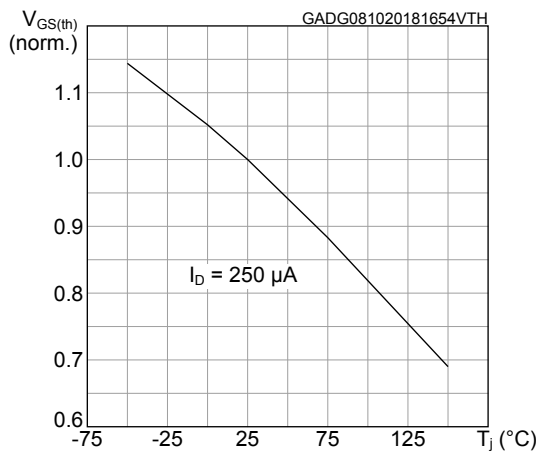
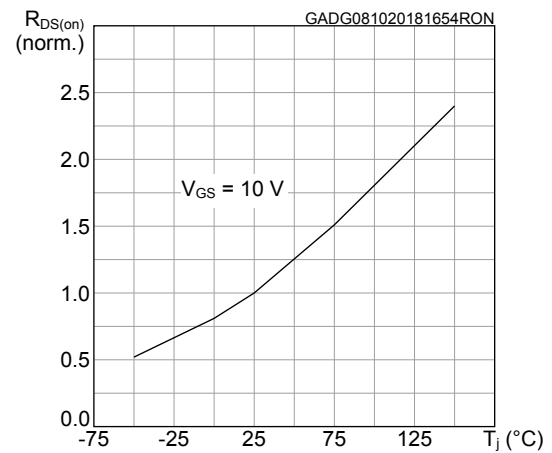
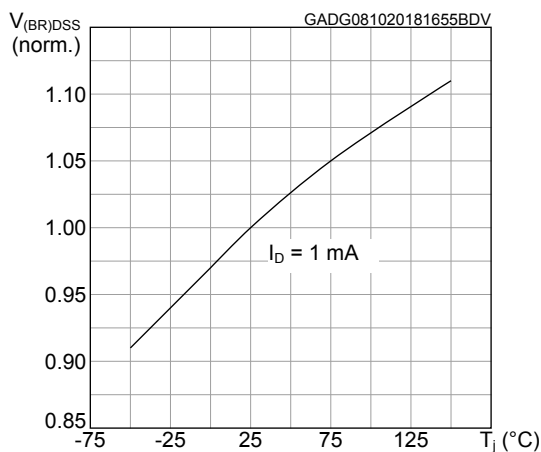
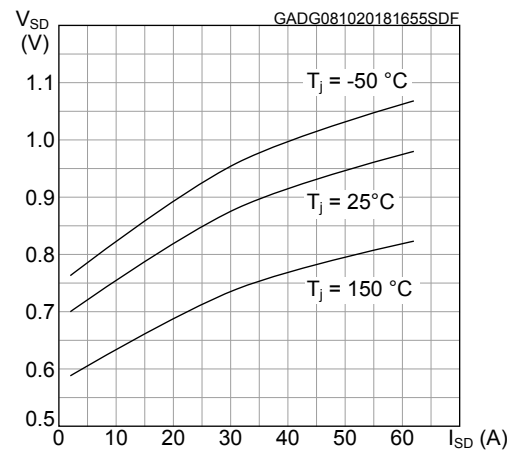
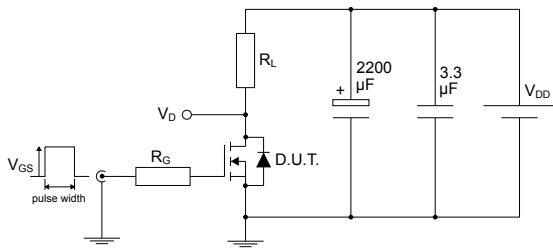
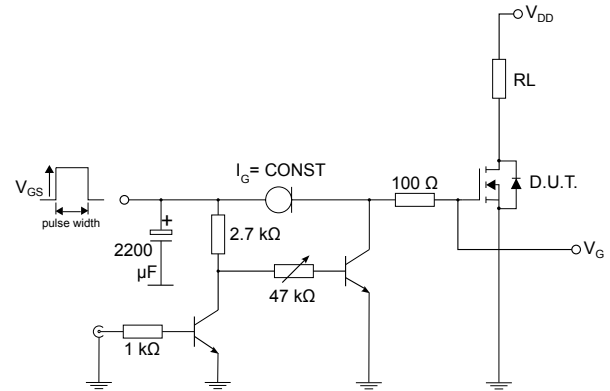

Figure 7. Capacitance variations

Figure 8. C_{oss} stored energy vs V_{DS}

Figure 9. Normalized gate threshold voltage vs temperature

Figure 10. Normalized on-resistance vs temperature

Figure 11. Normalized $V_{(BR)DSS}$ vs temperature

Figure 12. Source-drain diode forward characteristics

3 Test circuits

Figure 13. Test circuit for resistive load switching times

AM01468v1

Figure 14. Test circuit for gate charge behavior

AM01469v10

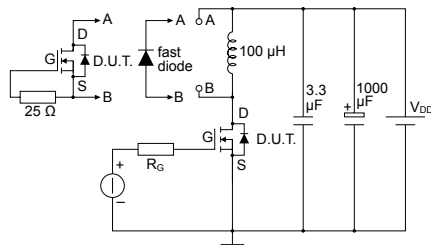
Figure 15. Test circuit for inductive load switching and diode recovery times

AM01470v1

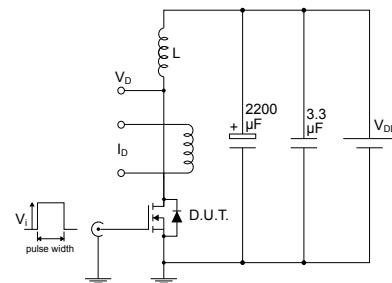
Figure 16. Unclamped inductive load test circuit

AM01471v1

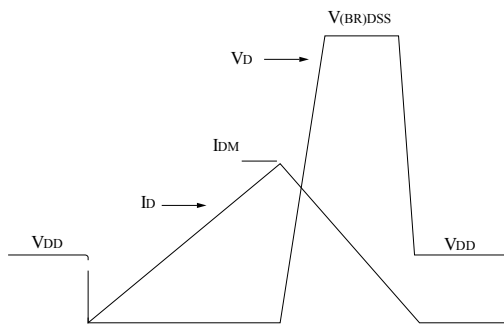
Figure 17. Unclamped inductive waveform

AM01472v1

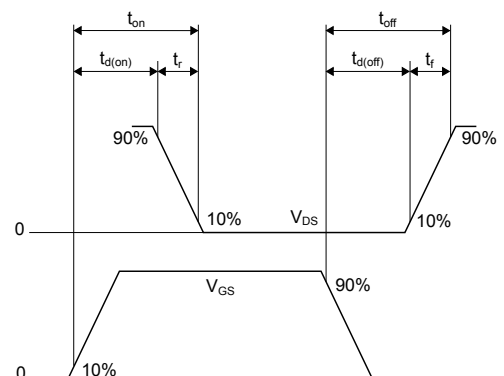
Figure 18. Switching time waveform

AM01473v1

4 Package information

In order to meet environmental requirements, ST offers these devices in different grades of **ECOPACK** packages, depending on their level of environmental compliance. ECOPACK specifications, grade definitions and product status are available at: www.st.com. ECOPACK is an ST trademark.

4.1 TO-247 package information

Figure 19. TO-247 package outline

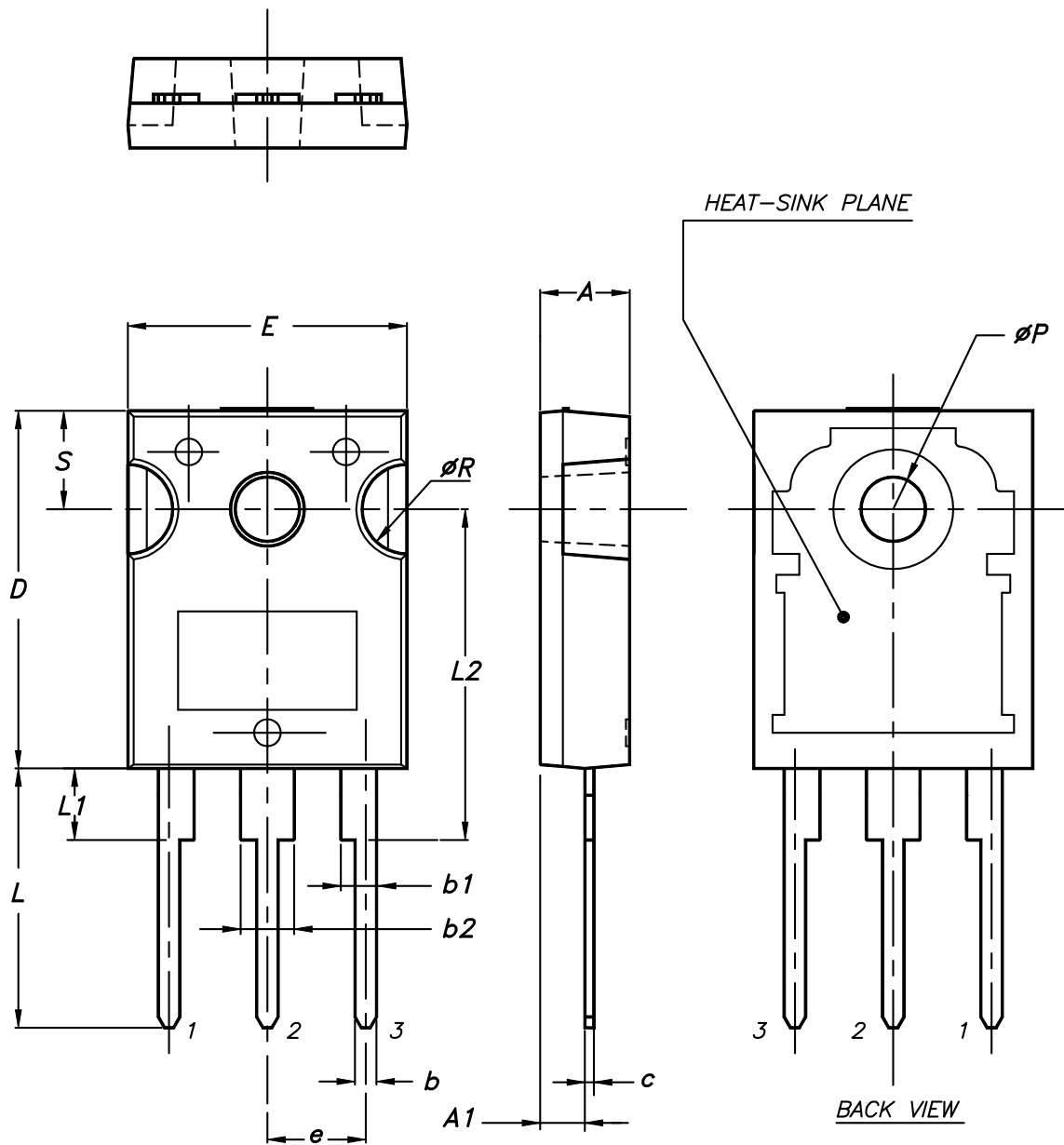

0075325_9

Table 8. TO-247 package mechanical data

Dim.	mm		
	Min.	Typ.	Max.
A	4.85		5.15
A1	2.20		2.60
b	1.0		1.40
b1	2.0		2.40
b2	3.0		3.40
c	0.40		0.80
D	19.85		20.15
E	15.45		15.75
e	5.30	5.45	5.60
L	14.20		14.80
L1	3.70		4.30
L2		18.50	
ØP	3.55		3.65
ØR	4.50		5.50
S	5.30	5.50	5.70

4.2 TO-247 long leads package information

Figure 20. TO-247 long leads package outline

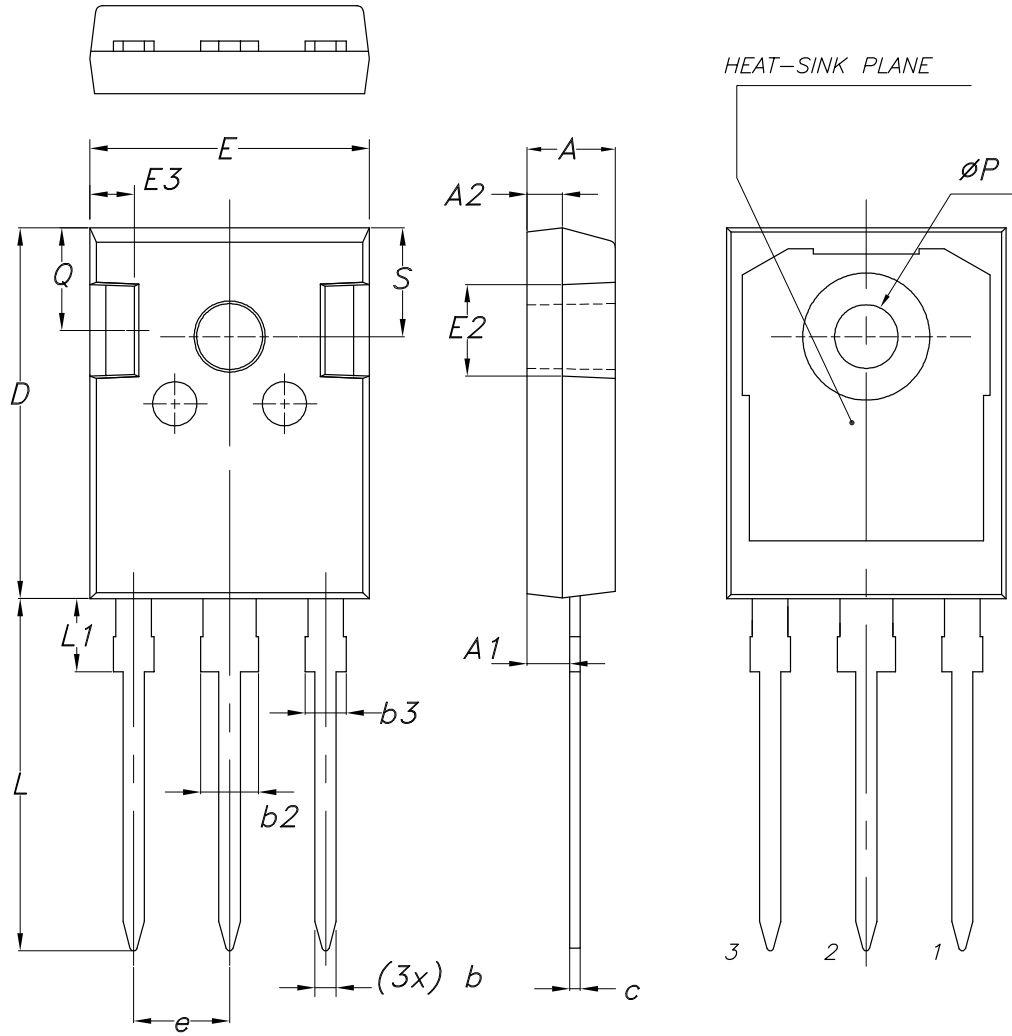

8463846_2_F

Table 9. TO-247 long leads package mechanical data

Dim.	mm		
	Min.	Typ.	Max.
A	4.90	5.00	5.10
A1	2.31	2.41	2.51
A2	1.90	2.00	2.10
b	1.16		1.26
b2			3.25
b3			2.25
c	0.59		0.66
D	20.90	21.00	21.10
E	15.70	15.80	15.90
E2	4.90	5.00	5.10
E3	2.40	2.50	2.60
e	5.34	5.44	5.54
L	19.80	19.92	20.10
L1			4.30
P	3.50	3.60	3.70
Q	5.60		6.00
S	6.05	6.15	6.25

Revision history

Table 10. Document revision history

Date	Revision	Changes
02-Nov-2017	1	First release.
10-Oct-2018	2	Removed maturity status indication from cover page. The document status is production data. Updated Section 1 Electrical ratings and Section 2 Electrical characteristics. Added Section 2.1 Electrical characteristics (curves). Minor text changes.
02-May-2019	3	Updated Table 6. Switching times. Minor text changes.
01-Jun-2020	4	Updated Table 1. Absolute maximum ratings and Table 7. Source drain diode.

Contents

1	Electrical ratings	2
2	Electrical characteristics	3
2.1	Electrical characteristics (curves)	5
3	Test circuits	7
4	Package information	8
4.1	TO-247 package information	8
4.2	TO-247 long leads package information	10
	Revision history	12

IMPORTANT NOTICE – PLEASE READ CAREFULLY

STMicroelectronics NV and its subsidiaries (“ST”) reserve the right to make changes, corrections, enhancements, modifications, and improvements to ST products and/or to this document at any time without notice. Purchasers should obtain the latest relevant information on ST products before placing orders. ST products are sold pursuant to ST’s terms and conditions of sale in place at the time of order acknowledgement.

Purchasers are solely responsible for the choice, selection, and use of ST products and ST assumes no liability for application assistance or the design of Purchasers’ products.

No license, express or implied, to any intellectual property right is granted by ST herein.

Resale of ST products with provisions different from the information set forth herein shall void any warranty granted by ST for such product.

ST and the ST logo are trademarks of ST. For additional information about ST trademarks, please refer to www.st.com/trademarks. All other product or service names are the property of their respective owners.

Information in this document supersedes and replaces information previously supplied in any prior versions of this document.

© 2020 STMicroelectronics – All rights reserved

X-ON Electronics

Largest Supplier of Electrical and Electronic Components

Click to view similar products for [MOSFET](#) category:

Click to view products by [STMicroelectronics](#) manufacturer:

Other Similar products are found below :

[614233C](#) [648584F](#) [IRFD120](#) [JANTX2N5237](#) [FCA20N60_F109](#) [FDZ595PZ](#) [2SK2545\(Q,T\)](#) [405094E](#) [423220D](#) [TPCC8103,L1Q\(CM](#)
[MIC4420CM-TR](#) [VN1206L](#) [SBVS138LT1G](#) [614234A](#) [715780A](#) [NTNS3166NZT5G](#) [SSM6J414TU,LF\(T](#) [751625C](#) [BUK954R8-60E](#)
[NTE6400](#) [SQJ402EP-T1-GE3](#) [2SK2614\(TE16L1,Q\)](#) [2N7002KW-FAI](#) [DMN1017UCP3-7](#) [EFC2J004NUZTDG](#) [ECH8691-TL-W](#)
[FCAB21350L1](#) [P85W28HP2F-7071](#) [DMN1053UCP4-7](#) [NTE221](#) [NTE2384](#) [NTE2903](#) [NTE2941](#) [NTE2945](#) [NTE2946](#) [NTE2960](#) [NTE2967](#)
[NTE2969](#) [NTE2976](#) [NTE455](#) [NTE6400A](#) [NTE2910](#) [NTE2916](#) [NTE2956](#) [NTE2911](#) [DMN2080UCB4-7](#) [TK10A80W,S4X\(S](#)
[SSM6P69NU,LF](#) [DMP22D4UFO-7B](#) [DMN1006UCA6-7](#)