

4 x 50 W multifunction quad power amplifier with built-in diagnostics feature

Datasheet – production data

Features

- Multipower BCD technology
- MOSFET output power stage
- DMOS power output
- New high efficiency (class SB)
- High output power capability 4 x 28 W / 4 Ω @ 14.4 V, 1 kHz, 10 % THD, 4 x 50 W max power
- Max. output power 4 x 72 W / 2 Ω
- Full I²C bus driving:
 - Standby
 - Independent front/rear soft play/mute
 - Selectable gain 30 dB / 16 dB (for low noise line output function)
 - High efficiency enable/disable
 - I²C bus digital diagnostics (including DC and AC load detection)
- Full fault protection
- DC offset detection
- Four independent short circuit protection
- Clipping detector pin with selectable threshold (2 % / 10 %)
- Standby/mute pin
- Linear thermal shutdown with multiple thermal warning
- ESD protection

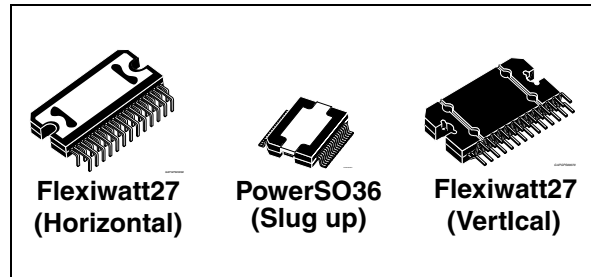

Description

The TDA7563B is a new BCD technology quad bridge type of car radio amplifier in Flexiwatt27 & PowerSO36 packages specially intended for car radio applications.

Thanks to the DMOS output stage the TDA7563B has a very low distortion allowing a clear powerful sound. Among the features, its superior efficiency performance coming from the internal exclusive structure, makes it the most suitable device to simplify the thermal management in high power sets.

The dissipated output power under average listening condition is in fact reduced up to 50 % when compared to the level provided by conventional class AB solutions.

This device is equipped with a full diagnostics array that communicates the status of each speaker through the I²C bus.

Table 1. Device summary

Order code	Package	Packing
TDA7563B	Flexiwatt27 (vertical)	Tube
TDA7563BH	Flexiwatt27 (horizontal)	Tube
TDA7563BPD	PowerSO36	Tube
TDA7563BPDTR	PowerSO36	Tape and reel

Contents

1	Block diagram and application circuit	6
2	Pins description	7
3	Electrical specifications	8
3.1	Absolute maximum ratings	8
3.2	Thermal data	8
3.3	Electrical characteristics	8
3.4	Electrical characteristics curves	11
4	Diagnostics functional description	14
4.1	Turn-on diagnostic	14
4.2	Permanent diagnostics	16
4.3	Output DC offset detection	17
4.4	AC diagnostic	17
5	Multiple faults	19
5.1	Faults availability	19
6	Thermal protection	20
6.1	Fast muting	20
7	I²C bus	21
7.1	I ² C programming/reading sequences	21
7.2	I2C bus interface	21
7.2.1	Data validity	21
7.2.2	Start and stop conditions	21
7.2.3	Byte format	21
7.2.4	Acknowledge	22
8	Software specifications	23
9	Examples of bytes sequence	28

10 **Package information** **29**

11 **Revision history** **32**

List of tables

Table 1.	Device summary	1
Table 2.	Absolute maximum ratings	8
Table 3.	Thermal data	8
Table 4.	Electrical characteristics	8
Table 5.	Double fault table for turn on diagnostic	19
Table 6.	IB1	23
Table 7.	IB2	24
Table 8.	DB1	24
Table 9.	DB2	25
Table 10.	DB3	26
Table 11.	DB4	27
Table 12.	Document revision history	32

List of figures

Figure 1.	Block diagram	6
Figure 2.	Application circuit	6
Figure 3.	Pins connection diagram of the Flexiwatt27 (top view)	7
Figure 4.	Pins connection diagram of the PowerSO36 slug up (top view)	7
Figure 5.	Quiescent current vs. supply voltage	11
Figure 6.	Output power vs. supply voltage (4Ω)	11
Figure 7.	Output power vs. supply voltage (2Ω)	11
Figure 8.	Distortion vs. output power (4Ω, STD)	11
Figure 9.	Distortion vs. output power (4Ω, HI-EFF)	12
Figure 10.	Distortion vs. output power (2Ω, STD)	12
Figure 11.	Distortion vs. frequency (4Ω)	12
Figure 12.	Distortion vs. frequency (2Ω)	12
Figure 13.	Crosstalk vs. frequency	12
Figure 14.	Supply voltage rejection vs. frequency	12
Figure 15.	Power dissipation and efficiency vs. output power (4Ω, STD, SINE)	13
Figure 16.	Power dissipation and efficiency vs. output power (4Ω, HI-EFF, SINE)	13
Figure 17.	Power dissipation vs. average output power (audio program simulation, 4Ω)	13
Figure 18.	Power dissipation vs. average output power (audio program simulation, 2Ω)	13
Figure 19.	Turn-on diagnostic: working principle	14
Figure 20.	SVR and output behavior (case 1: without turn-on diagnostic)	14
Figure 21.	SVR and output pin behavior (case 2: with turn-on diagnostic)	15
Figure 22.	Thresholds for short to GND/V _S	15
Figure 23.	Thresholds for short across the speaker/open speaker	15
Figure 24.	Thresholds for line-drivers	15
Figure 25.	Restart timing without diagnostic enable (permanent)	16
Figure 26.	Restart timing with diagnostic enable (permanent)	16
Figure 27.	Current detection: Load impedance Z _L vs. output peak voltage	18
Figure 28.	Thermal foldback diagram	20
Figure 29.	Data validity on the I2C bus	22
Figure 30.	Timing diagram on the I2C bus	22
Figure 31.	Timing acknowledge clock pulse	22
Figure 32.	Flexiwatt27 (horizontal) mechanical data and package dimensions	29
Figure 33.	Flexiwatt27 (vertical) mechanical data and package dimensions	30
Figure 34.	PowerSO36 (slug up) mechanical data and package dimensions	31

1 Block diagram and application circuit

Figure 1. Block diagram

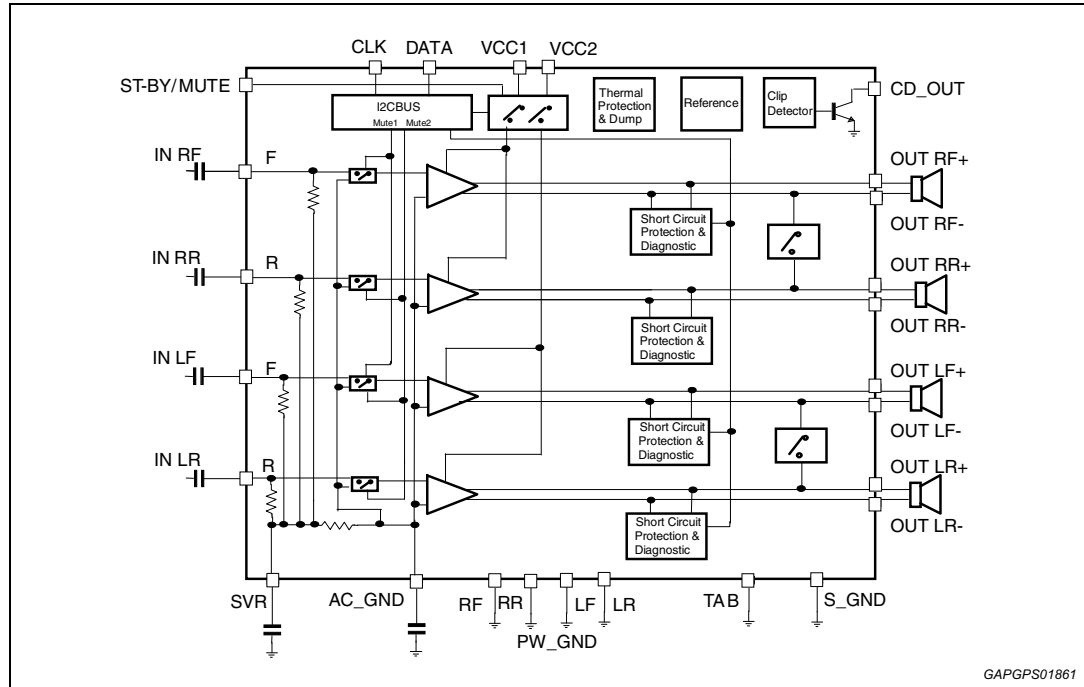

GAPGPS01861

Figure 2. Application circuit

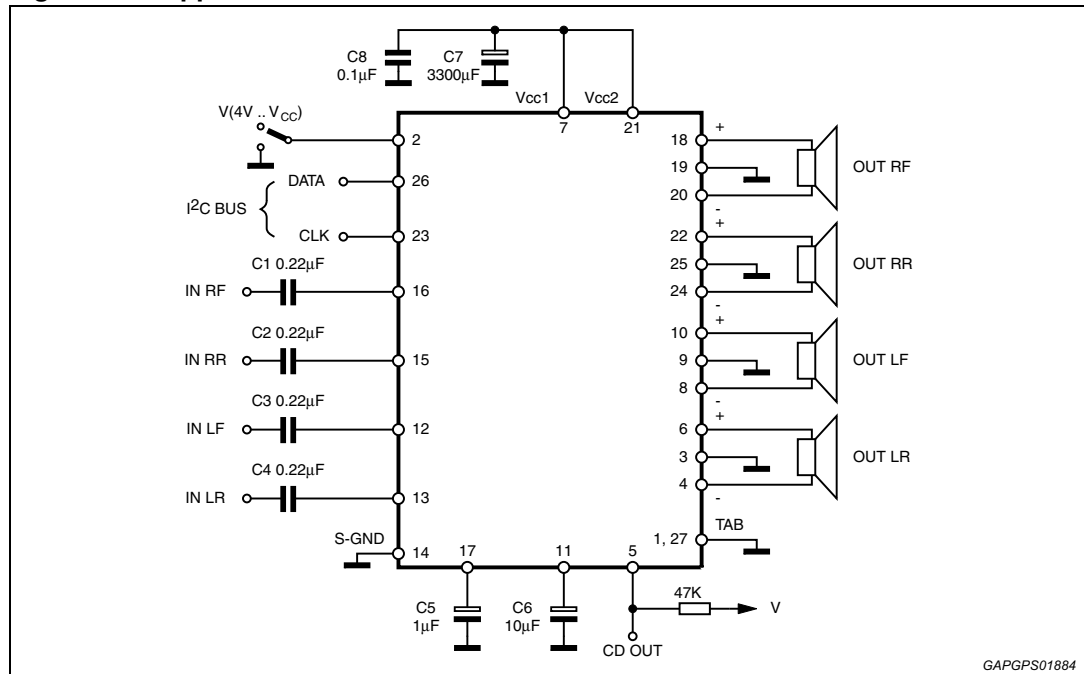

GAPGPS01884

2 Pins description

Figure 3. Pins connection diagram of the Flexiwatt27 (top view)

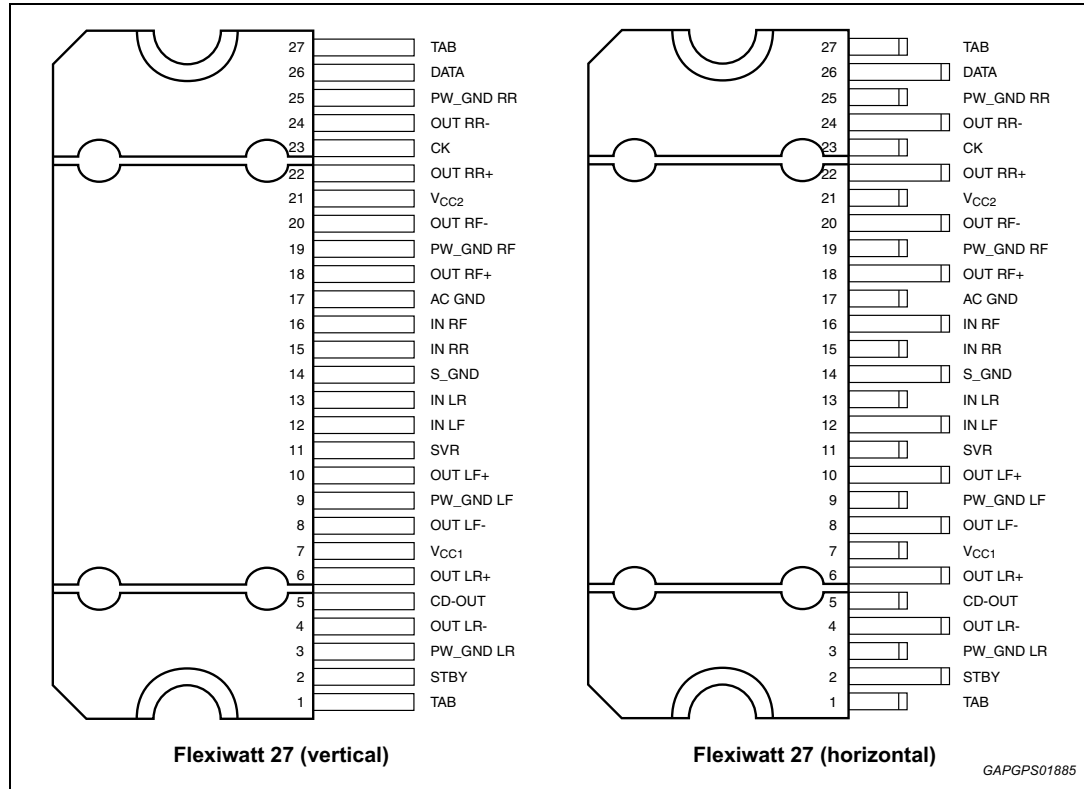
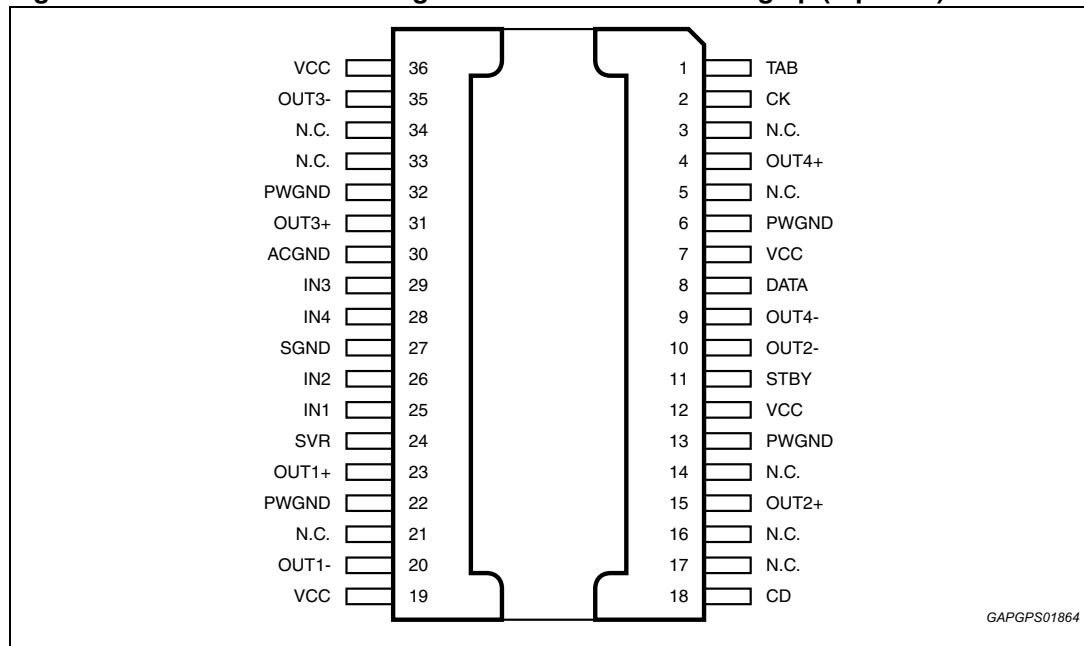

Figure 4. Pins connection diagram of the PowerSO36 slug up (top view)



3 Electrical specifications

3.1 Absolute maximum ratings

Table 2. Absolute maximum ratings

Symbol	Parameter	Value	Unit
V_{op}	Operating supply voltage	18	V
V_S	DC supply voltage	28	V
V_{peak}	Peak supply voltage (for $t = 50$ ms)	50	V
V_{CK}	CK pin voltage	6	V
V_{DATA}	Data pin voltage	6	V
I_O	Output peak current (not repetitive $t = 100$ ms)	8	A
I_O	Output peak current (repetitive $f > 10$ Hz)	6	A
P_{tot}	Power dissipation $T_{case} = 70$ °C	85	W
T_{stg}, T_j	Storage and junction temperature	-55 to 150	°C

3.2 Thermal data

Table 3. Thermal data

Symbol	Parameter	PowerSO36	Flexiwatt 27	Unit
$R_{th j-case}$	Thermal resistance junction-to-case Max	1	1	°C/W

3.3 Electrical characteristics

Refer to the test circuit, $V_S = 14.4$ V; $R_L = 4$ Ω; $f = 1$ kHz; $G_V = 30$ dB; $T_{amb} = 25$ °C; unless otherwise specified.

Table 4. Electrical characteristics

Symbol	Parameter	Test condition	Min.	Typ.	Max.	Unit
Power amplifier						
V_S	Supply voltage range	-	8	-	18	V
I_d	Total quiescent drain current	-	-	170	300	mA
P_O	Output power	Max. power ($V_S = 15.2$ V, square wave input (2-V _{rms}))	-	50	-	W
		THD = 10-%	25	28	-	W
		THD = 1-%	20	22	-	W

Table 4. Electrical characteristics (continued)

Symbol	Parameter	Test condition	Min.	Typ.	Max.	Unit
P_O	Output power	$R_L = 2 \Omega$; EIAJ ($V_S = 13.7 \text{ V}$)	55	68		W
		$R_L = 2 \Omega$; THD 10 %	40	50	-	
		$R_L = 2 \Omega$; THD 1 %	32	40		
		$R_L = 2 \Omega$; max power	60	75		
THD	Total harmonic distortion	$P_O = 1 \text{ W to } 10 \text{ W}$; STD mode	-	0.03	0.1	%
		HE mode; $P_O = 1.5 \text{ W}$		0.02	0.1	
		HE mode; $P_O = 8 \text{ W}$		0.15	0.5	
		$P_O = 1\text{-}10 \text{ W}$, $f = 10 \text{ kHz}$	-	0.2	0.5	%
		$G_V = 16 \text{ dB}$; STD mode	-	0.02	0.05	%
		$V_O = 0.1 \text{ to } 5 V_{\text{RMS}}$				
C_T	Cross talk	$f = 1 \text{ kHz to } 10 \text{ kHz}$, $R_g = 600 \Omega$	50	60	-	dB
R_{IN}	Input impedance	-	60	100	130	k Ω
G_{V1}	Voltage gain 1	-	29.5	30	30.5	dB
ΔG_{V1}	Voltage gain match 1	-	-1	-	1	dB
G_{V2}	Voltage gain 2	-	15.5	16	16.5	dB
ΔG_{V2}	Voltage gain match 2	-	-1	-	1	dB
E_{IN1}	Output noise voltage 1	$R_g = 600 \Omega$ 20 Hz to 22 kHz	-	50	100	μV
E_{IN2}	Output noise voltage 2	$R_g = 600 \Omega$; $G_V = 16 \text{ dB}$ 20 Hz to 22 kHz	-	15	30	μV
SVR	Supply voltage rejection	$f = 100 \text{ Hz to } 10 \text{ kHz}$; $V_r = 1 \text{ Vpk}$; $R_g = 600 \Omega$	50	60	-	dB
BW	Power bandwidth	-	100	-	-	kHz
A_{SB}	Standby attenuation	-	90	110	-	dB
I_{SB}	Standby current	$V_{\text{st-by}} = 0$	-	1	10	μA
A_M	Mute attenuation	-	80	100	-	dB
V_{OS}	Offset voltage	Mute and play	-100	0	100	mV
V_{AM}	Min. supply mute threshold	-	7	7.5	8	V
T_{ON}	Turn on delay	D2/D1 (IB1) 0 to 1	-	5	20	ms
T_{OFF}	Turn off delay	D2/D1 (IB1) 1 to 0	-	5	20	ms
V_{SBY}	Standby/mute pin for st-by	-	0	-	1.5	V
V_{MU}	Standby/mute pin for mute	-	3.5	-	5	V
CMRR	Input CMRR	$V_{CM} = 1 \text{ Vpk-pk}$; $R_g = 0 \Omega$	-	55	-	dB
V_{OP}	Standby/mute pin for operating	-	7	-	V_S	V
I_{MU}	Standby/mute pin current	$V_{\text{st-by/mute}} = 8.5 \text{ V}$	-	20	40	μA
		$V_{\text{st-by/mute}} < 1.5 \text{ V}$	-	0	5	μA
CD_{LK}	Clip det high leakage current	CD off / $V_{CD} = 6 \text{ V}$	-	0	5	μA
CD_{SAT}	Clip det sat. voltage	CD on; $I_{CD} = 1 \text{ mA}$	-	-	300	mV

Table 4. Electrical characteristics (continued)

Symbol	Parameter	Test condition	Min.	Typ.	Max.	Unit
CD _{THD}	Clip det THD level	D0 (IB1) = 1	5	10	15	%
		D0 (IB1) = 0	1	2	3	%
Turn on diagnostics 1 (Power amplifier mode)						
Pgnd	Short to GND det. (below this limit, the Output is considered in short circuit to GND)	Power amplifier in standby	-	-	1.2	V
Pvs	Short to Vs det. (above this limit, the output is considered in short circuit to Vs)		Vs -1.2	-	-	V
Pnop	Normal operation thresholds. (within these limits, the output is considered without faults).		1.8	-	Vs -1.8	V
Lsc	Shorted load det.		-	-	0.5	Ω
Lop	Open load det.		130	-		Ω
Lnop	Normal load det.		1.5	-	70	Ω
Turn on diagnostics 2 (Line driver mode)						
Pgnd	Short to GND det. (below this limit, the output is considered in short circuit to GND)	Power amplifier in standby	-	-	1.2	V
Pvs	Short to Vs det. (above this limit, the output is considered in short circuit to Vs)		Vs -1.2	-	-	V
Pnop	Normal operation thresholds. (within these limits, the output is considered without faults).		1.8	-	Vs -1.8	V
Lsc	Shorted load det.		-	-	1.5	Ω
Lop	Open Load det.		400	-		Ω
Lnop	Normal Load det.		4.5	-	200	Ω
Permanent diagnostics 2 (Power amplifier mode or line driver mode)						
Pgnd	Short to GND det. (below this limit, the output is considered in short circuit to GND)	Power amplifier in mute or play, one or more short circuits protection activated	-	-	1.2	V
Pvs	Short to Vs det. (above this limit, the output is considered in short circuit to Vs)		Vs -1.2	-	-	V
Pnop	Normal operation thresholds. (within these limits, the output is considered without faults).		1.8	-	Vs -1.8	V
L _{SC}	Shorted load det.	Power amplifier mode	-	-	0.5	Ω
		Line driver mode	-	-	1.5	Ω

Table 4. Electrical characteristics (continued)

Symbol	Parameter	Test condition	Min.	Typ.	Max.	Unit
V_O	Offset detection	Power amplifier in play, AC input signals = 0	± 1.5	± 2	± 2.5	V
I_{NL}	Normal load current detection	$V_O < (V_S - 5)pk$	500	-	-	mA
I_{OL}	Open load current detection		-	-	250	mA
I²C bus interface						
S_{CL}	Clock frequency	-	-	-	400	kHz
V_{IL}	Input low voltage	-	-	-	1.5	V
V_{IH}	Input high voltage	-	2.3	-	-	V

3.4 Electrical characteristics curves

Figure 5. Quiescent current vs. supply voltage Figure 6. Output power vs. supply voltage (4Ω)

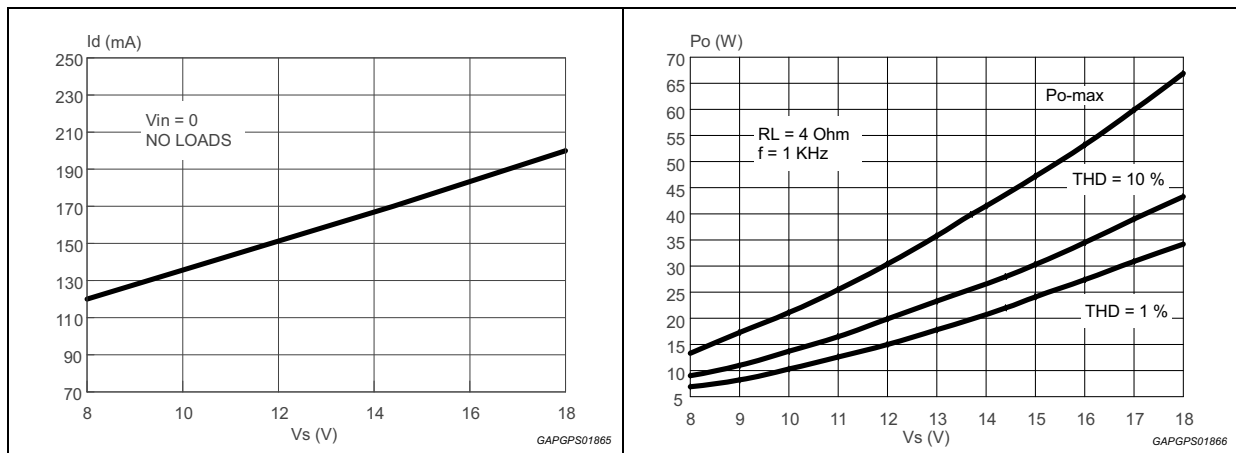

Figure 7. Output power vs. supply voltage (2Ω) Figure 8. Distortion vs. output power (4Ω, STD)

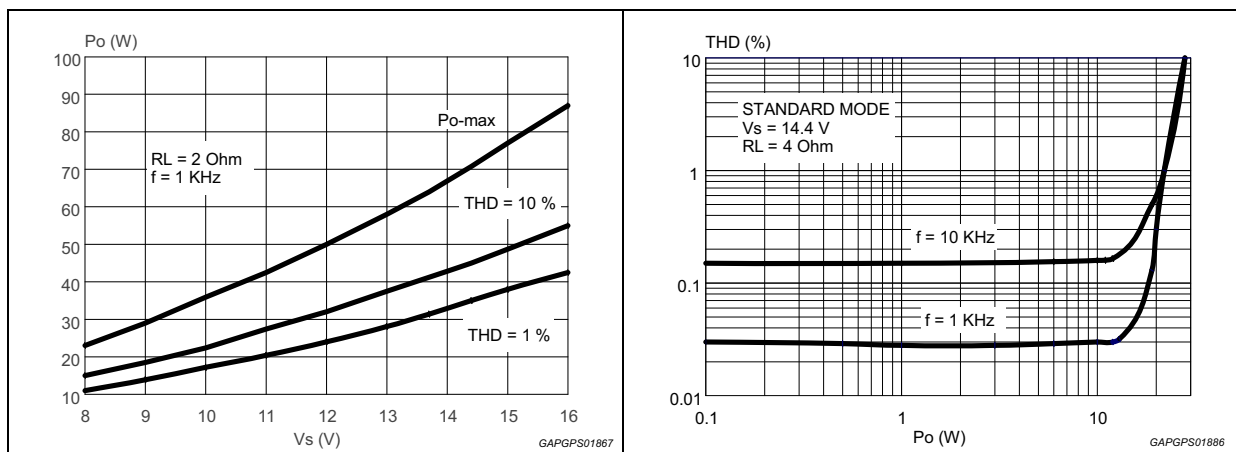

Figure 9. Distortion vs. output power (4Ω, HI-EFF)

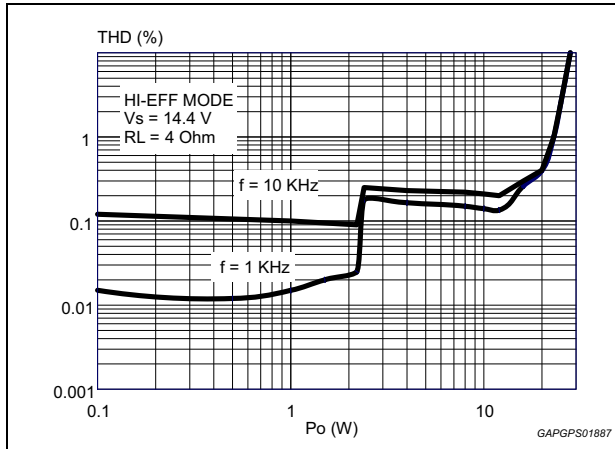

Figure 10. Distortion vs. output power (2Ω, STD)

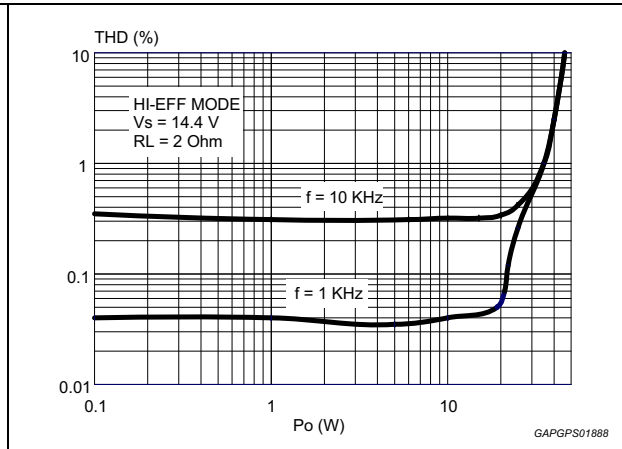

Figure 11. Distortion vs. frequency (4Ω)

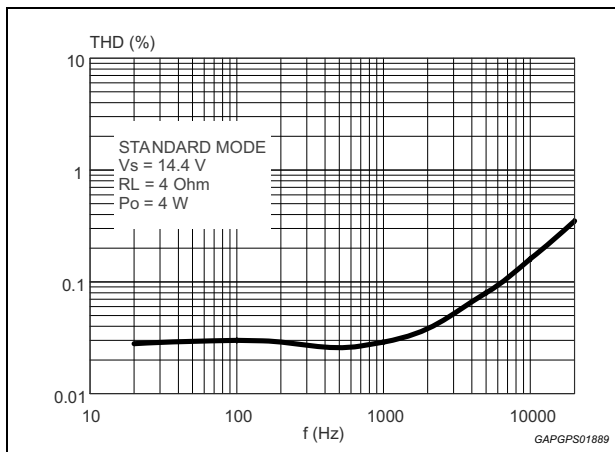

Figure 12. Distortion vs. frequency (2Ω)

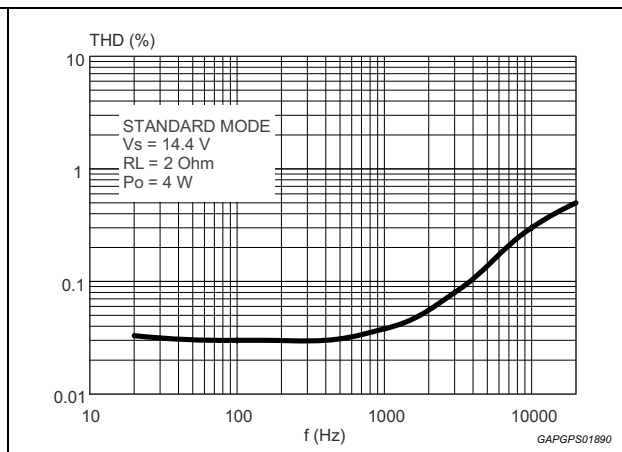

Figure 13. Crosstalk vs. frequency

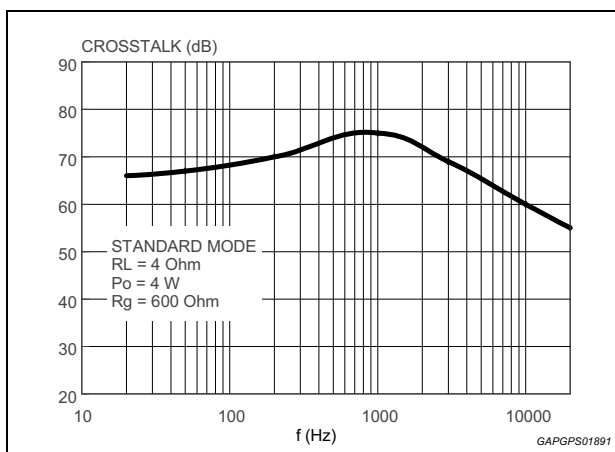

Figure 14. Supply voltage rejection vs. frequency

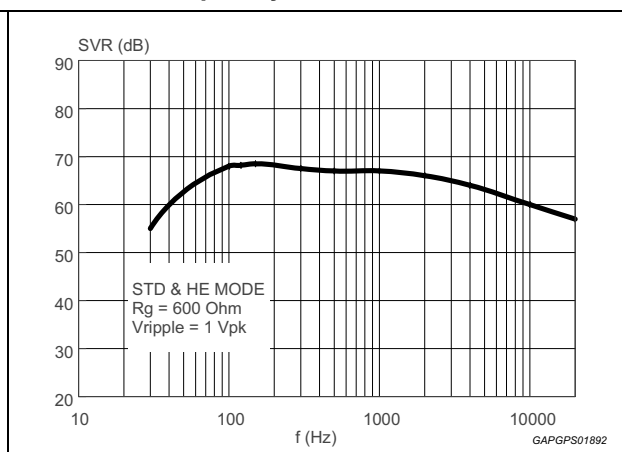

Figure 15. Power dissipation and efficiency vs. output power (4Ω, STD, SINE)

Figure 16. Power dissipation and efficiency vs. output power (4Ω, HI-EFF, SINE)

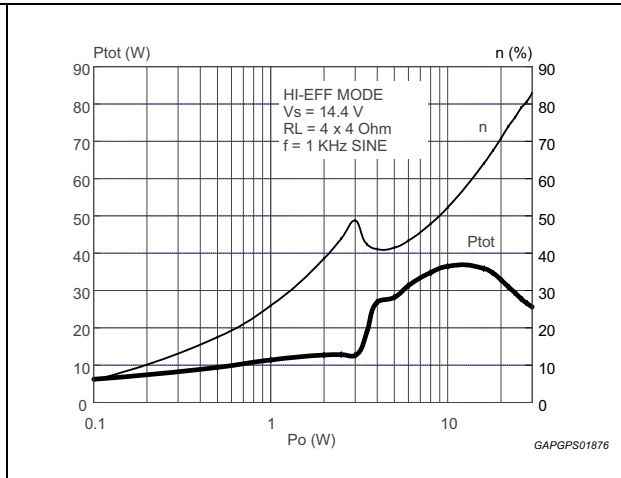
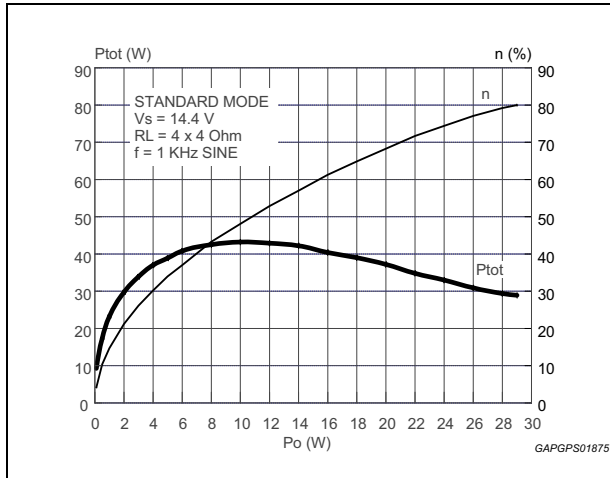
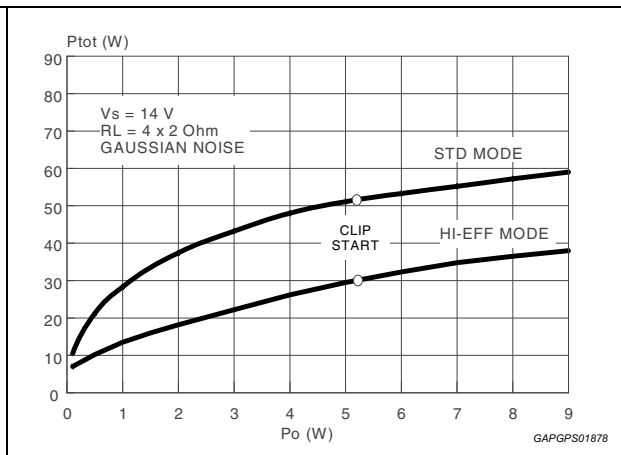
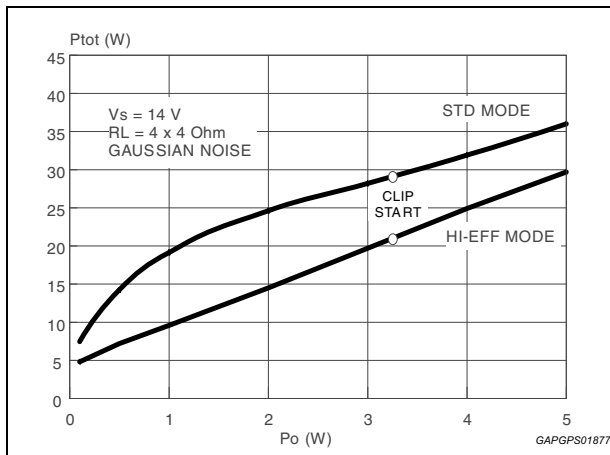

Figure 17. Power dissipation vs. average output power (audio program simulation, 4Ω)

Figure 18. Power dissipation vs. average output power (audio program simulation, 2Ω)



4 Diagnostics functional description

4.1 Turn-on diagnostic

It is activated at the turn-on (standby out) under I²C bus request. Detectable output faults are:

- Short to GND
- Short to Vs
- Short across the speaker
- Open speaker

To verify if any of the above misconnections are in place, a subsonic (inaudible) current pulse (Figure 19) is internally generated, sent through the speaker(s) and sunk back. The turn on diagnostic status is internally stored until a successive diagnostic pulse is requested (after a I²C reading).

If the "standby out" and "diag. enable" commands are both given through a single programming step, the pulse takes place first (power stage still in standby mode, low, outputs= high impedance).

Afterwards, when the amplifier is biased, the permanent diagnostic takes place. The previous turn on state is kept until a short appears at the outputs.

Figure 19. Turn-on diagnostic: working principle

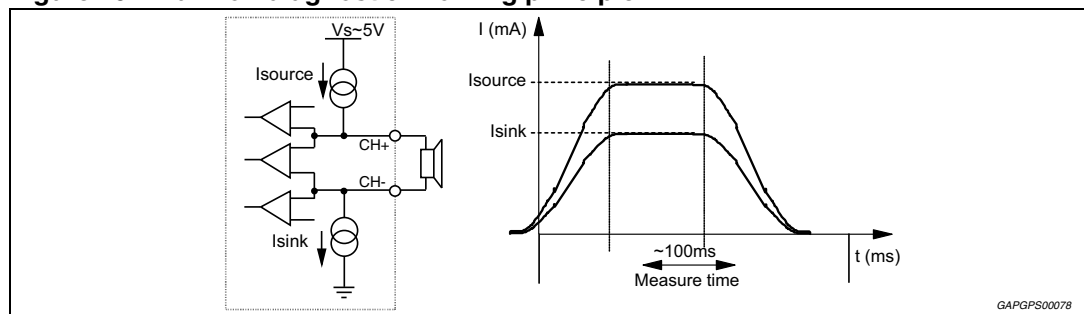

Figure 20 and 21 show SVR and output waveforms at the turn-on (standby out) with and without turn-on diagnostic.

Figure 20. SVR and output behavior (case 1: without turn-on diagnostic)

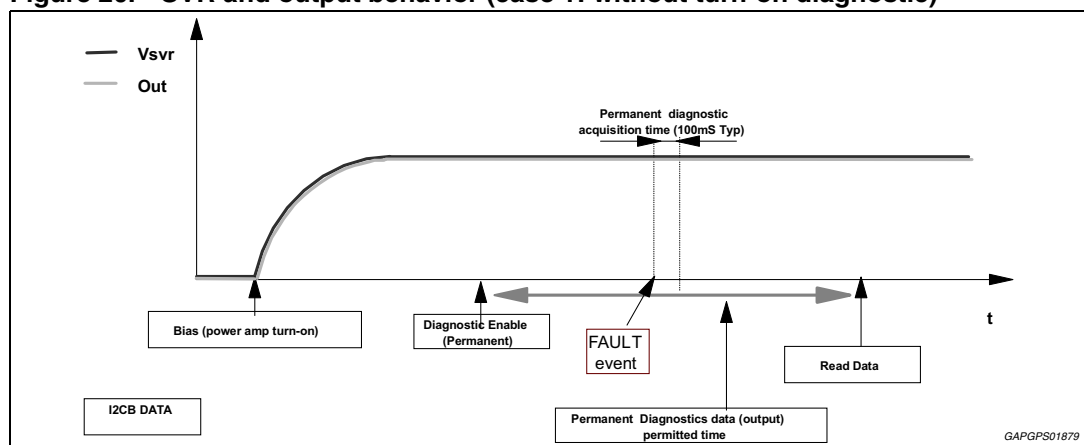
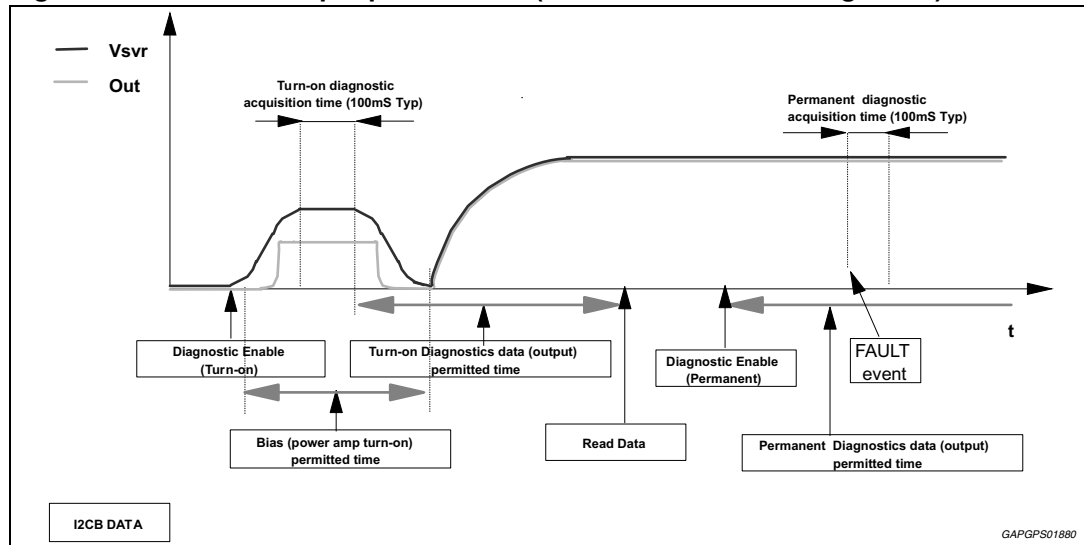
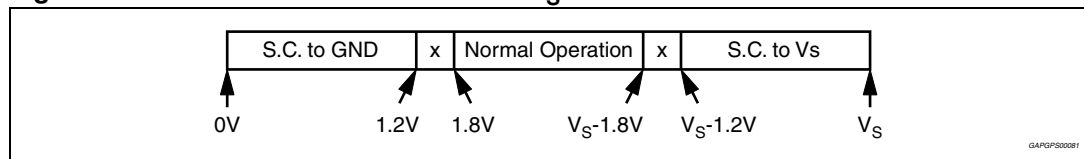

Figure 21. SVR and output pin behavior (case 2: with turn-on diagnostic)



The information related to the outputs status is read and memorized at the end of the current pulse top. The acquisition time is 100 ms (typ.). No audible noise is generated in the process. As for short to GND / Vs the fault-detection thresholds remain unchanged from 30 dB to 16 dB gain setting. They are as follows:

Figure 22. Thresholds for short to GND/Vs



Concerning short across the speaker / open speaker, the threshold varies from 30 dB to 16 dB gain setting, since different loads are expected (either normal speaker's impedance or high impedance). The values in case of 30 dB gain are as follows:

Figure 23. Thresholds for short across the speaker/open speaker

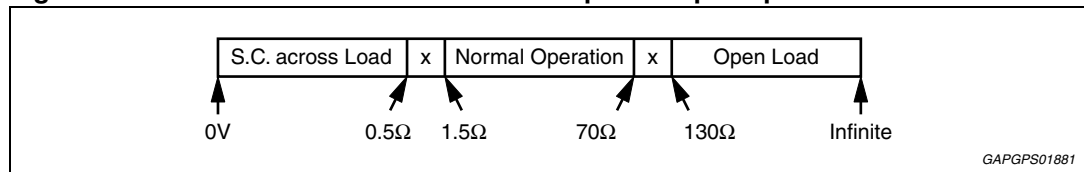

If the line-driver mode ($G_v = 16$ dB and line driver mode diagnostic = 1) is selected, the same thresholds will change as follows:

Figure 24. Thresholds for line-drivers

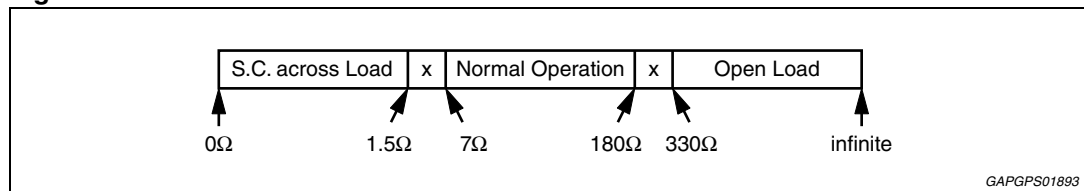

4.2 Permanent diagnostics

Detectable conventional faults are:

- Short to GND
- Short to Vs
- Short across the speaker

The following additional features are provided:

- Output offset detection

The TDA7563B has 2 operating statuses:

1. Restart mode. The diagnostic is not enabled. Each audio channel operates independently of each other. If any of the a.m. faults occurs, only the channel(s) interested is shut down. A check of the output status is made every 1 ms (Figure 25). Restart takes place when the overload is removed.
2. Diagnostic mode. It is enabled via I²C bus and self activates if an output overload (such as to cause the intervention of the short-circuit protection) occurs to the speakers outputs. Once activated, the diagnostics procedure develops as follows (Figure 26):
 - To avoid momentary re-circulation spikes from giving erroneous diagnostics, a check of the output status is made after 1ms: if normal situation (no overloads) is detected, the diagnostic is not performed and the channel returns active.
 - Instead, if an overload is detected during the check after 1 ms, then a diagnostic cycle having a duration of about 100 ms is started.
 - After a diagnostic cycle, the audio channel interested by the fault is switched to restart mode. The relevant data are stored inside the device and can be read by the microprocessor. When one cycle has terminated, the next one is activated by an I²C reading. This is to ensure continuous diagnostics throughout the car-radio operating time.
3. To check the status of the device a sampling system is needed. The timing is chosen at microprocessor level (over half a second is recommended).

Figure 25. Restart timing without diagnostic enable (permanent) - Each 1ms time, a sampling of the fault is done

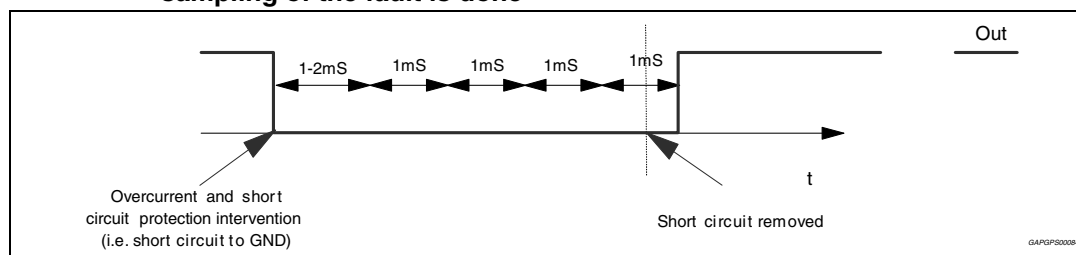
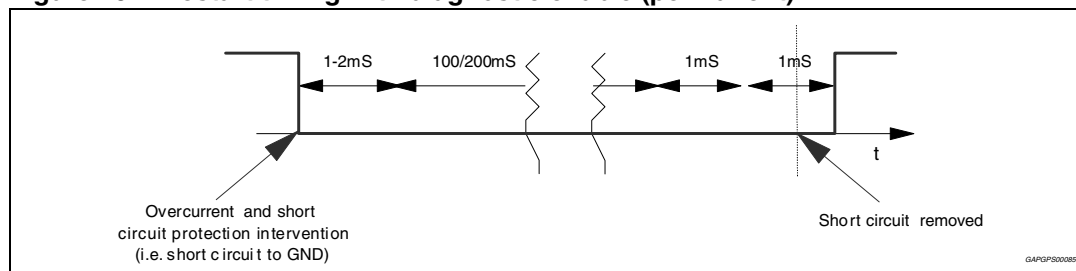

Figure 26. Restart timing with diagnostic enable (permanent)



4.3 Output DC offset detection

Any DC output offset exceeding ± 2 V is signalled out. This inconvenient might occur as a consequence of initially defective or aged and worn-out input capacitors feeding a DC component to the inputs, so putting the speakers at risk of overheating.

This diagnostic has to be performed with low-level output AC signal (or $V_{in} = 0$).

The test is run with selectable time duration by microprocessor (from a "start" to a "stop" command):

- Start = Last reading operation or setting IB1 - D5 - (offset enable) to 1

The TDA7563B signals out an offset to the user if this offset condition is stable during the assigned testing time. This feature is disabled if any overloads leading to activation of the short-circuit protection occurs in the process.

4.4 AC diagnostic

It is targeted at detecting accidental disconnection of tweeters in 2-way speaker and, more in general, presence of capacitively (AC) coupled loads.

This diagnostic is based on the notion that the overall speaker's impedance (woofer + parallel tweeter) will tend to increase towards high frequencies if the tweeter gets disconnected, because the remaining speaker (woofer) would be out of its operating range (high impedance). The diagnostic decision is made according to peak output current thresholds, as follows:

$I_{out} > 500 \text{ mApk} = \text{normal status}$

$I_{out} < 250 \text{ mApk} = \text{open tweeter}$

To correctly implement this feature, it is necessary to briefly provide a signal tone (with the amplifier in "play") whose frequency and magnitude are such as to determine an output current higher than 500 mApk with in normal conditions and lower than 250 mApk should the parallel tweeter be missing.

The test has to last for a minimum number of 3 sine cycles starting from the activation of the AC diagnostic function IB2 < D2 > 0 up to the I²C reading of the results (measuring period). To confirm presence of tweeter, it is necessary to find at least 3 current pulses over 500 mA over all the measuring period, else an "open tweeter" message will be issued.

The frequency / magnitude setting of the test tone depends on the impedance characteristics of each specific speaker being used, with or without the tweeter connected (to be calculated case by case). High-frequency tones (> 10 kHz) or even ultrasonic signals are recommended for their negligible acoustic impact and also to maximize the impedance module's ratio between with tweeter-on and tweeter-off.

Figure 27 shows the load impedance as a function of the peak output voltage and the relevant diagnostic fields.

This feature is disabled if any overloads leading to activation of the short-circuit protection occurs in the process.

Figure 27. Current detection: Load impedance |Z| vs. output peak voltage

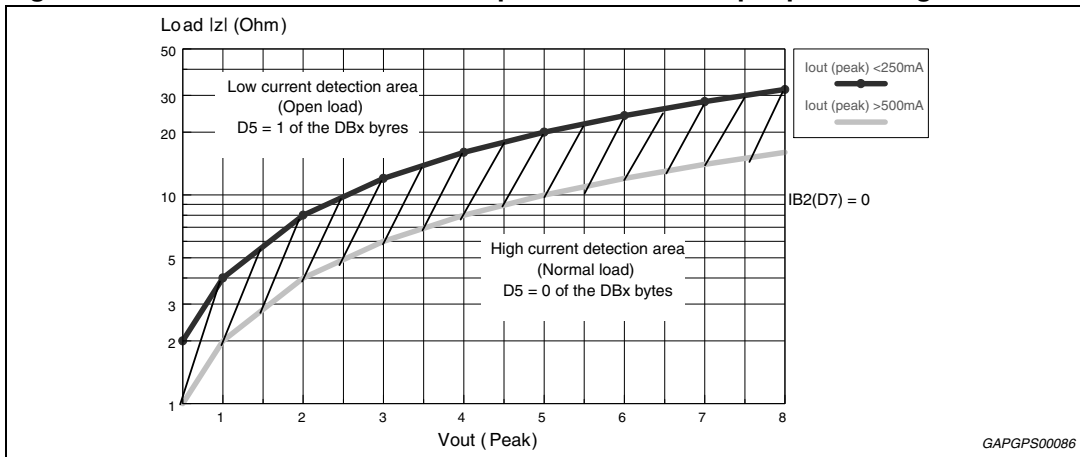

5 Multiple faults

When more misconnections are simultaneously in place at the audio outputs, it is guaranteed that at least one of them is initially read out. The others are notified after successive cycles of I²C reading and faults removal, provided that the diagnostic is enabled. This is true for both kinds of diagnostic (Turn on and Permanent).

The table below shows all the couples of double-fault possible. It should be taken into account that a short circuit with the 4 ohm speaker unconnected is considered as double fault.

Table 5. Double fault table for turn on diagnostic

	S. GND (so)	S. GND (sk)	S. Vs	S. Across L.	Open L.
S. GND (so)	S. GND	S. GND	S. Vs + S. GND	S. GND	S. GND
S. GND (sk)	/	S. GND	S. Vs	S. GND	Open L. (*)
S. Vs	/	/	S. Vs	S. Vs	S. Vs
S. Across L.	/	/	/	S. Across L.	N.A.
Open L.	/	/	/	/	Open L. (*)

S. GND (so) / S. GND (sk) in the above table make a distinction according to which of the 2 outputs is shorted to ground (test-current source side = so, test-current sink side = sk). More precisely, in Channels LF and RR, so = CH+, sk = CH-; in Channels LR and RF, so = CH-, sk = CH+.

In permanent diagnostic the table is the same, with only a difference concerning open load (*), which is not among the recognizable faults. Should an open load be present during the device's normal working, it would be detected at a subsequent Turn on Diagnostic cycle (i.e. at the successive car radio turn-on).

5.1 Faults availability

All the results coming from I²C bus, by read operations, are the consequence of measurements inside a defined period of time. If the fault is stable throughout the whole period, it will be sent out.

To guarantee always resident functions, every kind of diagnostic cycles (turn-on, permanent, offset) will be reactivate after any I²C reading operation. So, when the micro reads the I²C, a new cycle will be able to start, but the read data will come from the previous diag. cycle (i.e. The device is in turn-on state, with a short to GND, then the short is removed and micro reads I²C. The short to GND is still present in bytes, because it is the result of the previous cycle. If another I²C reading operation occurs, the bytes do not show the short). In general to observe a change in diagnostic bytes, two I²C reading operations are necessary.

6 Thermal protection

Thermal protection is implemented through thermal foldback (*Figure 28*).

Thermal foldback begins limiting the audio input to the amplifier stage as the junction temperatures rise above the normal operating range. This effectively limits the output power capability of the device thus reducing the temperature to acceptable levels without totally interrupting the operation of the device.

The output power will decrease to the point at which thermal equilibrium is reached. Thermal equilibrium will be reached when the reduction in output power reduces the dissipated power such that the die temperature falls below the thermal foldback threshold. Should the device cool, the audio level will increase until a new thermal equilibrium is reached or the amplifier reaches full power. Thermal foldback will reduce the audio output level in a linear manner.

Three thermal warning are available through the I²C bus data.

Figure 28. Thermal foldback diagram

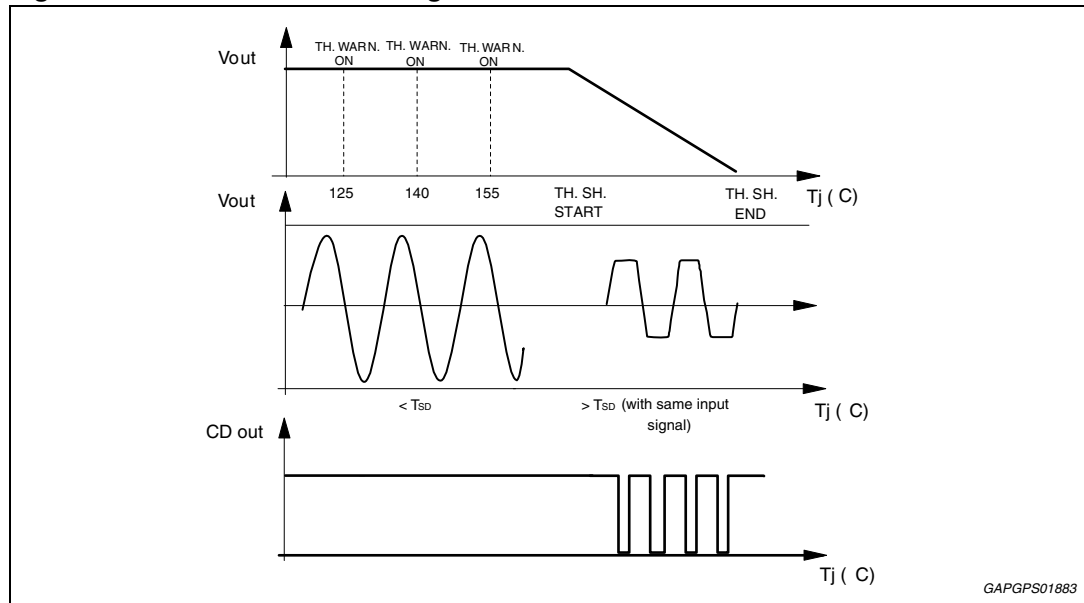

6.1 Fast muting

The muting time can be shortened to less than 1.5 ms by setting (IB2) D5 = 1. This option can be useful in transient battery situations (i.e. during car engine cranking) to quickly turnoff the amplifier for avoid any audible effects caused by noise/transients being injected by preamp stages. The bit must be set back to “0” shortly after the mute transition.

7 I²C bus

7.1 I²C programming/reading sequences

A correct turn on/off sequence respectful of the diagnostic timings and producing no audible noises could be as follows (after battery connection):

- TURN-ON: PIN2 > 7 V --- 10 ms --- (STANDBY OUT + DIAG ENABLE) --- 500 ms (min) --- MUTING OUT
- TURN-OFF: MUTING IN --- 20 ms --- (DIAG DISABLE + STANDBY IN) --- 10 ms - -- PIN2 = 0
- Car radio installation: PIN2 > 7V --- 10ms DIAG ENABLE (write) --- 200 ms --- I²C read (repeat until All faults disappear).
- OFFSET TEST: Device in play (no signal) -- OFFSET ENABLE - 30 ms - I²C reading (repeat I²C reading until high-offset message disappears).

7.2 I²C bus interface

Data transmission from microprocessor to the TDA7563B and viceversa takes place through the 2 wires I²C bus interface, consisting of the two lines SDA and SCL (pull-up resistors to positive supply voltage must be connected).

7.2.1 Data validity

As shown by [Figure 29](#), the data on the SDA line must be stable during the high period of the clock. The high and low state of the data line can only change when the clock signal on the SCL line is low.

7.2.2 Start and stop conditions

As shown by [Figure 30](#) a start condition is a high to low transition of the SDA line while SCL is high. The stop condition is a low to high transition of the SDA line while SCL is high.

7.2.3 Byte format

Every byte transferred to the SDA line must contain 8 bits. Each byte must be followed by an acknowledge bit. The MSB is transferred first.

7.2.4 Acknowledge

The transmitter* puts a resistive HIGH level on the SDA line during the acknowledge clock pulse (see [Figure 31](#)). The receiver**, in order to acknowledge, has to pull-down (LOW) the SDA line during the acknowledge clock pulse, so that the SDA line is stable LOW during this clock pulse.

* Transmitter

- master (μ P) when it writes an address to the TDA7563B
- slave (TDA7563B) when the μ P reads a data byte from TDA7563B

** Receiver

- slave (TDA7563B) when the μ P writes an address to the TDA7563B
- master (μ P) when it reads a data byte from TDA7563B

Figure 29. Data validity on the I²C bus

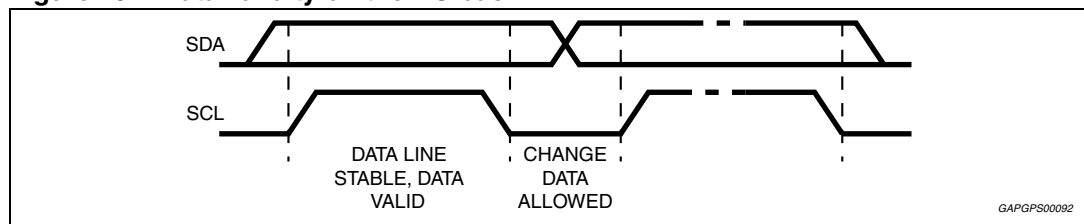

Figure 30. Timing diagram on the I²C bus

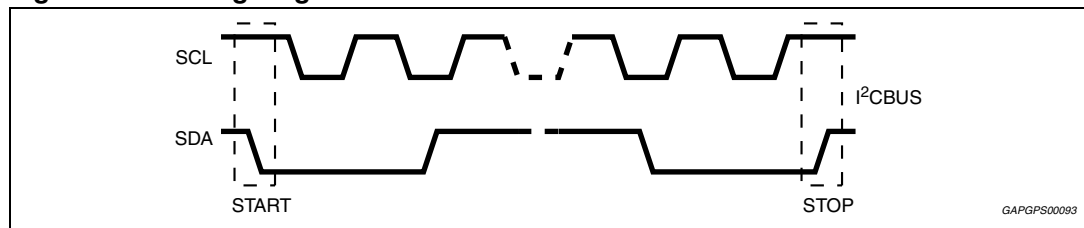
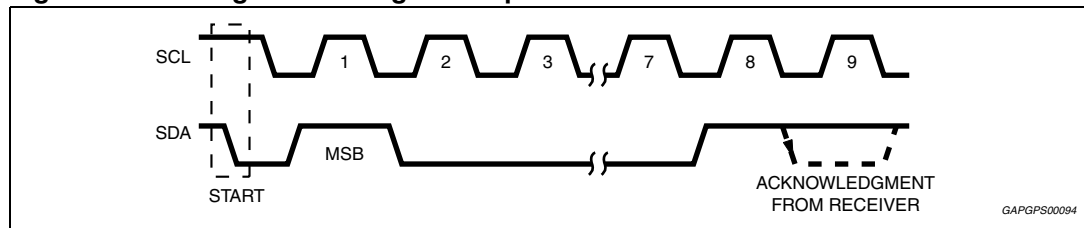

Figure 31. Timing acknowledge clock pulse



8 Software specifications

All the functions of the TDA7563B are activated by I²C interface.

The bit 0 of the "Address Byte" defines if the next bytes are write instruction (from μ P to TDA7563B) or read instruction (from TDA7563B to μ P).

Chip address

D7							D0	
1	1	0	1	1	0	0	X	D8 Hex

X = 0 Write to device

X = 1 Read from device

If R/W = 0, the μ P sends 2 "Instruction Bytes": IB1 and IB2.

Table 6. IB1

Bit	Instruction decoding bit
D7	0
D6	Diagnostic enable (D6 = 1) Diagnostic defeat (D6 = 0)
D5	Offset detection enable (D5 = 1) Offset detection defeat (D5 = 0)
D4	Front channel Gain = 30 dB (D4 = 0) Gain = 16 dB (D4 = 1)
D3	Rear channel Gain = 30 dB (D3 = 0) Gain = 16 dB (D3 = 1)
D2	Mute front channels (D2 = 0) Unmute front channels (D2 = 1)
D1	Mute rear channels (D1 = 0) Unmute rear channels (D1 = 1)
D0	CD 2% (D0 = 0) CD 10% (D0 = 1)

Table 7. IB2

Bit	Instruction decoding bit
D7	0
D6	0
D5	Normal muting time (D5 = 0) Fast muting time (D5 = 1)
D4	Standby on - Amplifier not working - (D4 = 0) Standby off - Amplifier working - (D4 = 1)
D3	Power amplifier mode diagnostic (D3 = 0) Line driver mode diagnostic (D3 = 1)
D2	Current detection diagnostic enabled (D2 = 1) Current detection diagnostic defeat (D2 = 0)
D1	Right channel power amplifier working in standard mode (D1 = 0) Power amplifier working in high efficiency mode (D1 = 1)
D0	Left channel power amplifier working in standard mode (D0 = 0) Power amplifier working in high efficiency mode (D0 = 1)

If R/W = 1, the TDA7563B sends 4 "Diagnostics Bytes" to μ P: DB1, DB2, DB3 and DB4.

Table 8. DB1

Bit	Instruction decoding bit
D7	Thermal warning 1 active (D7 = 1), $T_j = 155^\circ\text{C}$
D6	Diag. cycle not activated or not terminated (D6 = 0) Diag. cycle terminated (D6 = 1)
D5	Channel LF Current Detection Output peak current < 250mA - Output load (D5 = 1) Output peak current > 500mA - Output load (D5 = 0)
D4	Channel LF Turn-on diagnostic (D4 = 0) Permanent diagnostic (D4 = 1)
D3	Channel LF Normal load (D3 = 0) Short load (D3 = 1)
D2	Channel LF Turn-on diag.: No open load (D2 = 0) Open load detection (D2 = 1) Offset diag.: No output offset (D2 = 0) Output offset detection (D2 = 1)
D1	Channel LF No short to Vcc (D1 = 0) Short to Vcc (D1 = 1)
D0	Channel LF No short to GND (D1 = 0) Short to GND (D1 = 1)

Table 9. DB2

Bit	Instruction decoding bit
D7	Offset detection not activated (D7 = 0) Offset detection activated (D7 = 1)
D6	X
D5	Channel LR Current Detection Output peak current < 250mA - Output load (D5 = 1) Output peak current > 500mA - Output load (D5 = 0)
D4	Channel LR Turn-on diagnostic (D4 = 0) Permanent diagnostic (D4 = 1)
D3	Channel LR Normal load (D3 = 0) Short load (D3 = 1)
D2	Channel LR Turn-on diag.: No open load (D2 = 0) Open load detection (D2 = 1) Permanent diag.: No output offset (D2 = 0) Output offset detection (D2 = 1)
D1	Channel LR No short to Vcc (D1 = 0) Short to Vcc (D1 = 1)
D0	Channel LR No short to GND (D1 = 0) Short to GND (D1 = 1)

Table 10. DB3

Bit	Instruction decoding bit
D7	Standby status (= IB2 - D4)
D6	Diagnostic status (= IB1 - D6)
D5	Channel RF Current detection Output peak current <250mA - Output load (D5 = 1) Output peak current >500mA - Output load (D5 = 0)
D4	Channel RF Turn-on diagnostic (D4 = 0) Permanent diagnostic (D4 = 1)
D3	Channel RF Normal load (D3 = 0) Short load (D3 = 1)
D2	Channel RF Turn-on diag.: No open load (D2 = 0) Open load detection (D2 = 1) Permanent diag.: No output offset (D2 = 0) Output offset detection (D2 = 1)
D1	Channel RF No short to Vcc (D1 = 0) Short to Vcc (D1 = 1)
D0	Channel RF No short to GND (D1 = 0) Short to GND (D1 = 1)

Table 11. DB4

Bit	Instruction decoding bit
D7	Thermal warning 2 active (D7 = 1), $T_j = 140^\circ\text{C}$
D6	Thermal warning 3 active (D6 = 1) $T_j = 120^\circ\text{C}$
D5	Channel RR Current detection Output peak current <250mA - Output load (D5 = 1) Output peak current >500mA - Output load (D5 = 0)
D4	Channel RR Turn-on diagnostic (D4 = 0) Permanent diagnostic (D4 = 1)
D3	Channel R R Normal load (D3 = 0) Short load (D3 = 1)
D2	Channel RR Turn-on diag.: No open load (D2 = 0) Open load detection (D2 = 1) Permanent diag.: No output offset (D2 = 0) Output offset detection (D2 = 1)
D1	Channel RR No short to Vcc (D1 = 0) Short to Vcc (D1 = 1)
D0	Channel RR No short to GND (D1 = 0) Short to GND (D1 = 1)

9 Examples of bytes sequence

1 - Turn-On diagnostic - write operation

Start	Address byte with D0 = 0	ACK	IB1 with D6 = 1	ACK	IB2	ACK	STOP
-------	--------------------------	-----	-----------------	-----	-----	-----	------

2 - Turn-On diagnostic - read operation

Start	Address byte with D0 = 1	ACK	DB1	ACK	DB2	ACK	DB3	ACK	DB4	ACK	STOP
-------	--------------------------	-----	-----	-----	-----	-----	-----	-----	-----	-----	------

The delay from 1 to 2 can be selected by software, starting from 1ms

3a - Turn-on of the power amplifier with 30dB gain, mute on, diagnostic defeat, CD = 2%

Start	Address byte with D0 = 0	ACK	IB1	ACK	IB2	ACK	STOP
			X0000000		XXX1XX11		

3b - Turn-off of the power amplifier

Start	Address byte with D0 = 0	ACK	IB1	ACK	IB2	ACK	STOP
			X0XXXXXX		XXX0XXXX		

4 - Offset detection procedure enable

Start	Address byte with D0 = 0	ACK	IB1	ACK	IB2	ACK	STOP
			XX1XX11X		XXX1XXXX		

5 - Offset detection procedure stop and reading operation (the results are valid only for the offset detection bits (D2 of the bytes DB1, DB2, DB3, DB4)

Start	Address byte with D0 = 1	ACK	DB1	ACK	DB2	ACK	DB3	ACK	DB4	ACK	STOP
-------	--------------------------	-----	-----	-----	-----	-----	-----	-----	-----	-----	------

- The purpose of this test is to check if a D.C. offset (2V typ.) is present on the outputs, produced by input capacitor with anomalous leakage current or humidity between pins.
- The delay from 4 to 5 can be selected by software, starting from 1ms

10 Package information

In order to meet environmental requirements, ST offers these devices in different grades of ECOPACK® packages, depending on their level of environmental compliance. ECOPACK® specifications, grade definitions and product status are available at: www.st.com.

ECOPACK® is an ST trademark.

Figure 32. Flexiwatt27 (horizontal) mechanical data and package dimensions

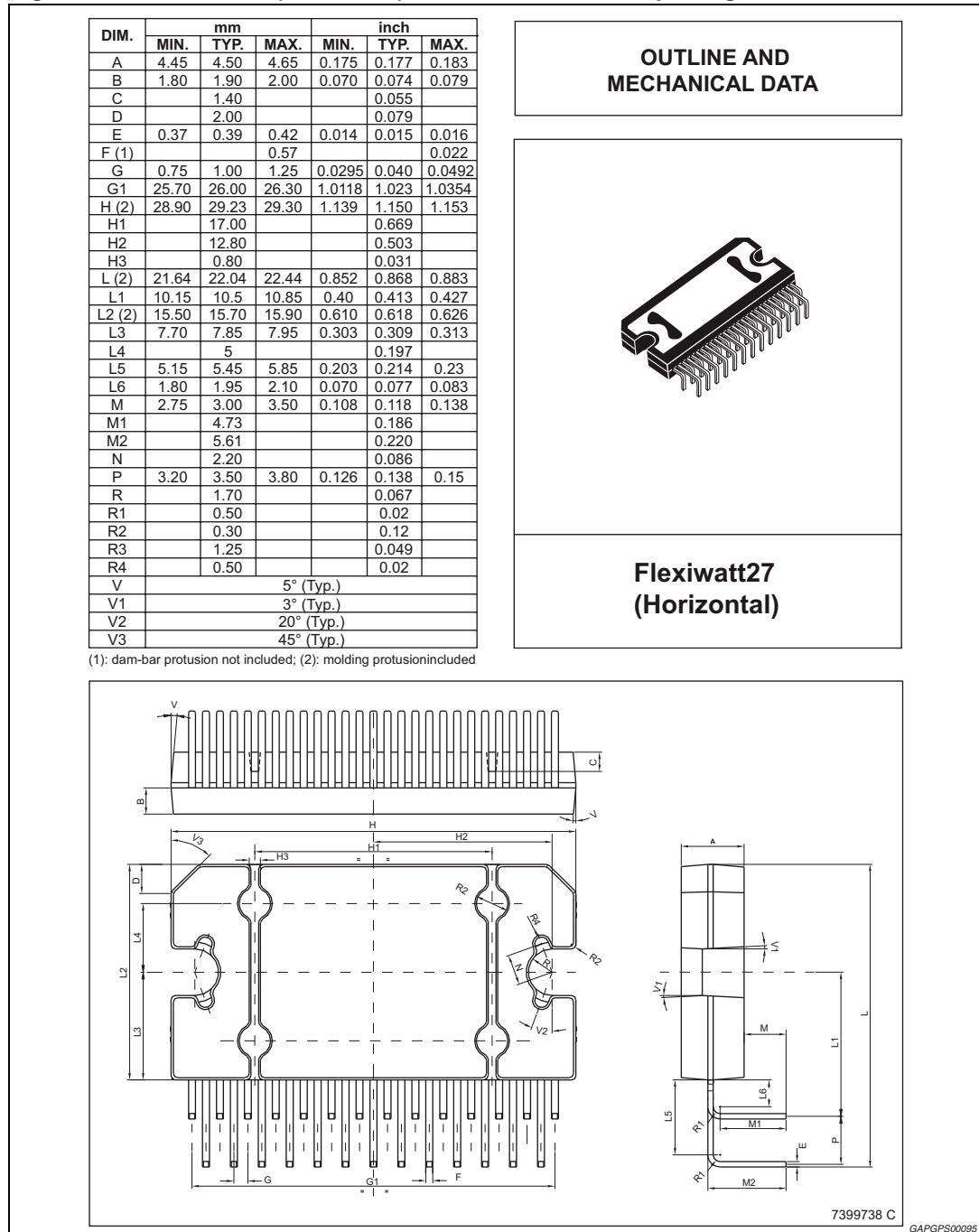
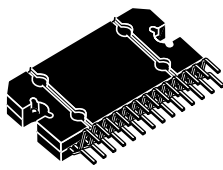

Figure 33. Flexiwatt27 (vertical) mechanical data and package dimensions

DIM.	mm			inch		
	MIN.	TYP.	MAX.	MIN.	TYP.	MAX.
A	4.45	4.50	4.65	0.175	0.177	0.183
B	1.80	1.90	2.00	0.070	0.074	0.079
C		1.40			0.055	
D	0.75	0.90	1.05	0.029	0.035	0.041
E	0.37	0.39	0.42	0.014	0.015	0.016
F ⁽¹⁾			0.57			0.022
G	0.80	1.00	1.20	0.031	0.040	0.047
G1	25.75	26.00	26.25	1.014	1.023	1.033
H ⁽²⁾	28.90	29.23	29.30	1.139	1.150	1.153
H1		17.00			0.669	
H2		12.80			0.503	
H3		0.80			0.031	
L ⁽²⁾	22.07	22.47	22.87	0.869	0.884	0.904
L1	18.57	18.97	19.37	0.731	0.747	0.762
L2 ⁽²⁾	15.50	15.70	15.90	0.610	0.618	0.626
L3	7.70	7.85	7.95	0.303	0.309	0.313
L4		5			0.197	
L5		3.5			0.138	
M	3.70	4.00	4.30	0.145	0.157	0.169
M1	3.60	4.00	4.40	0.142	0.157	0.173
N		2.20			0.086	
O		2			0.079	
R		1.70			0.067	
R1		0.5			0.02	
R2		0.3			0.12	
R3		1.25			0.049	
R4		0.50			0.019	
V					5° (Typ.)	
V1					3° (Typ.)	
V2					20° (Typ.)	
V3					45° (Typ.)	

(1): dam-bar protusion not included; (2): molding protusion included.

OUTLINE AND MECHANICAL DATA



Flexiwatt27 (vertical)

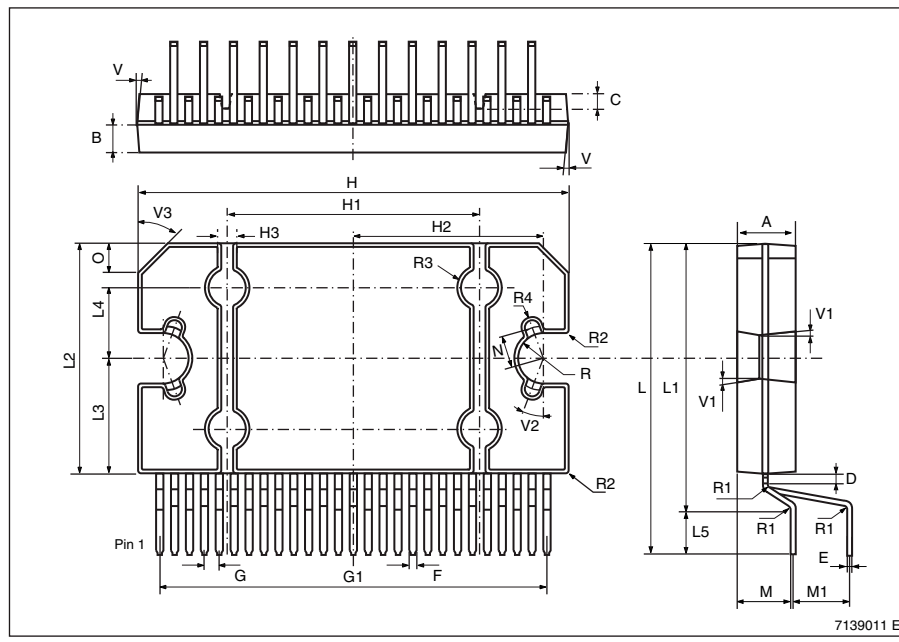

7139011 E
GAPGPS00096

Figure 34. PowerSO36 (slug up) mechanical data and package dimensions

DIM.	mm			inch		
	MIN.	TYP.	MAX.	MIN.	TYP.	MAX.
A	3.270	-	3.410	0.1287	-	0.1343
A2	3.100	-	3.180	0.1220	-	0.1252
A4	0.800	-	1.000	0.0315	-	0.0394
A5	-	0.200	-	-	0.0079	-
a1	0.030	-	-0.040	0.0012	-	-0.0016
b	0.220	-	0.380	0.0087	-	0.0150
c	0.230	-	0.320	0.0091	-	0.0126
D	15.800	-	16.000	0.6220	-	0.6299
D1	9.400	-	9.800	0.3701	-	0.3858
D2	-	1.000	-	-	0.0394	-
E	13.900	-	14.500	0.5472	-	0.5709
E1	10.900	-	11.100	0.4291	-	0.4370
E2	-	-	2.900	-	-	0.1142
E3	5.800	-	6.200	0.2283	-	0.2441
E4	2.900	-	3.200	0.1142	-	0.1260
e	-	0.650	-	-	0.0256	-
e3	-	11.050	-	-	0.4350	-
G	0	-	0.075	0	-	0.0031
H	15.500	-	15.900	0.6102	-	0.6260
h	-	-	1.100	-	-	0.0433
L	0.800	-	1.100	0.0315	-	0.0433
N	-	-	10°	-	-	10°
s	-	-	8°	-	-	8°

OUTLINE AND MECHANICAL DATA

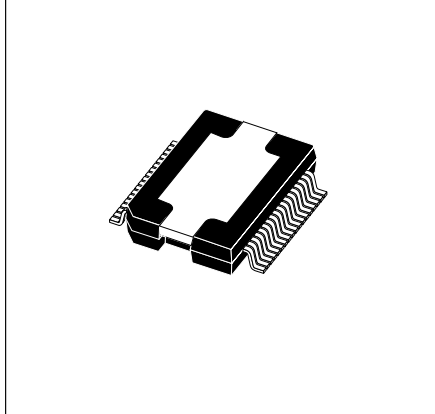

PowerSO36 (SLUG UP)

(1) "D and E1" do not include mold flash or protrusions.
Mold flash or protrusions shall not exceed 0.15mm (0.006").
(2) No intrusion allowed inwards the leads.

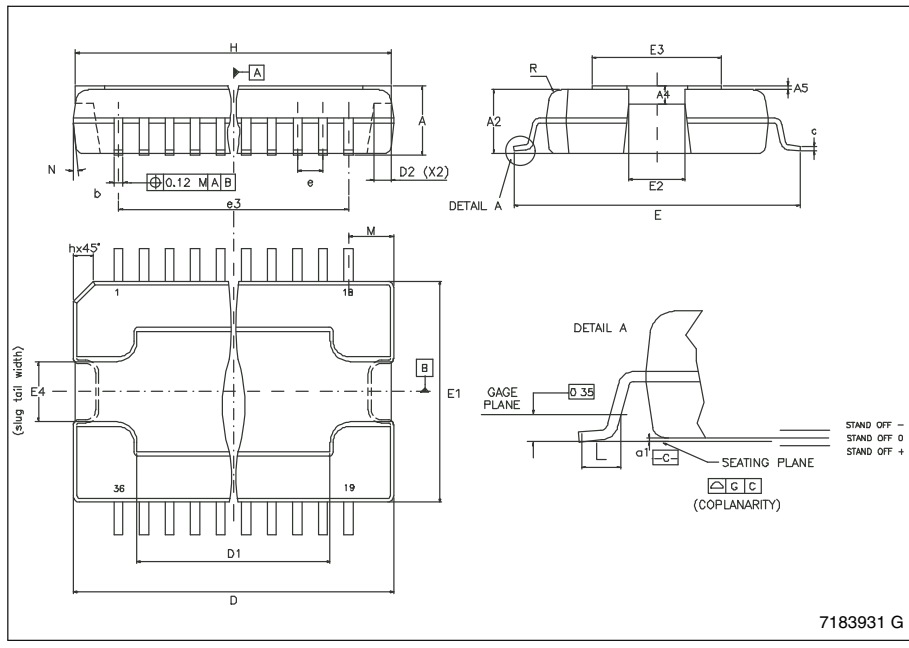

11 Revision history

Table 12. Document revision history

Date	Revision	Changes
05-Oct-2006	1	Initial release.
19-Dec-2007	2	Updated Table 3: Thermal data .
14-Dec-2009	3	Updated Figure 34: PowerSO36 (slug up) mechanical data and package dimensions on page 31 .
12-Sep-2012	4	Updated Section 10: Package information on page 29 .
11-Dec-2012	5	Corrected Pin 27 name of the Flexiwatt 27 (vertical) on the Figure 3 on page 7 . Corrected typeset error of the "a1" dimension on the Figure 34: PowerSO36 (slug up) mechanical data and package dimensions on page 31 .
17-Sep-2013	6	Updated Disclaimer.

Please Read Carefully:

Information in this document is provided solely in connection with ST products. STMicroelectronics NV and its subsidiaries ("ST") reserve the right to make changes, corrections, modifications or improvements, to this document, and the products and services described herein at any time, without notice.

All ST products are sold pursuant to ST's terms and conditions of sale.

Purchasers are solely responsible for the choice, selection and use of the ST products and services described herein, and ST assumes no liability whatsoever relating to the choice, selection or use of the ST products and services described herein.

No license, express or implied, by estoppel or otherwise, to any intellectual property rights is granted under this document. If any part of this document refers to any third party products or services it shall not be deemed a license grant by ST for the use of such third party products or services, or any intellectual property contained therein or considered as a warranty covering the use in any manner whatsoever of such third party products or services or any intellectual property contained therein.

UNLESS OTHERWISE SET FORTH IN ST'S TERMS AND CONDITIONS OF SALE ST DISCLAIMS ANY EXPRESS OR IMPLIED WARRANTY WITH RESPECT TO THE USE AND/OR SALE OF ST PRODUCTS INCLUDING WITHOUT LIMITATION IMPLIED WARRANTIES OF MERCHANTABILITY, FITNESS FOR A PARTICULAR PURPOSE (AND THEIR EQUIVALENTS UNDER THE LAWS OF ANY JURISDICTION), OR INFRINGEMENT OF ANY PATENT, COPYRIGHT OR OTHER INTELLECTUAL PROPERTY RIGHT.

ST PRODUCTS ARE NOT DESIGNED OR AUTHORIZED FOR USE IN: (A) SAFETY CRITICAL APPLICATIONS SUCH AS LIFE SUPPORTING, ACTIVE IMPLANTED DEVICES OR SYSTEMS WITH PRODUCT FUNCTIONAL SAFETY REQUIREMENTS; (B) AERONAUTIC APPLICATIONS; (C) AUTOMOTIVE APPLICATIONS OR ENVIRONMENTS, AND/OR (D) AEROSPACE APPLICATIONS OR ENVIRONMENTS. WHERE ST PRODUCTS ARE NOT DESIGNED FOR SUCH USE, THE PURCHASER SHALL USE PRODUCTS AT PURCHASER'S SOLE RISK, EVEN IF ST HAS BEEN INFORMED IN WRITING OF SUCH USAGE, UNLESS A PRODUCT IS EXPRESSLY DESIGNATED BY ST AS BEING INTENDED FOR "AUTOMOTIVE, AUTOMOTIVE SAFETY OR MEDICAL" INDUSTRY DOMAINS ACCORDING TO ST PRODUCT DESIGN SPECIFICATIONS. PRODUCTS FORMALLY ESCC, QML OR JAN QUALIFIED ARE DEEMED SUITABLE FOR USE IN AEROSPACE BY THE CORRESPONDING GOVERNMENTAL AGENCY.

Resale of ST products with provisions different from the statements and/or technical features set forth in this document shall immediately void any warranty granted by ST for the ST product or service described herein and shall not create or extend in any manner whatsoever, any liability of ST.

ST and the ST logo are trademarks or registered trademarks of ST in various countries.

Information in this document supersedes and replaces all information previously supplied.

The ST logo is a registered trademark of STMicroelectronics. All other names are the property of their respective owners.

© 2013 STMicroelectronics - All rights reserved

STMicroelectronics group of companies

Australia - Belgium - Brazil - Canada - China - Czech Republic - Finland - France - Germany - Hong Kong - India - Israel - Italy - Japan - Malaysia - Malta - Morocco - Philippines - Singapore - Spain - Sweden - Switzerland - United Kingdom - United States of America

www.st.com

X-ON Electronics

Largest Supplier of Electrical and Electronic Components

Click to view similar products for [Audio Amplifiers](#) category:

Click to view products by [STMicroelectronics](#) manufacturer:

Other Similar products are found below :

[LV47002P-E](#) [NCP2811AFCT1G](#) [NCP2890AFCT2G](#) [SSM2377ACBZ-R7](#) [IS31AP4915A-QFLS2-TR](#) [NCP2820FCT2G](#) [TDA1591T](#)
[TDA7563AH](#) [SSM2529ACBZ-R7](#) [SSM2518CBZ-R7](#) [MAX9890AETA+T](#) [TS2012EIJT](#) [NCP2809BMUTXG](#) [NJW1157BFC2](#)
[SSM2375CBZ-REEL7](#) [IS31AP4996-GRLS2-TR](#) [STPA002OD-4WX](#) [NCP2823BFCT1G](#) [MAX9717DETA+T](#) [MAX9717CETA+T](#)
[MAX9724AEBC+TG45](#) [LA4450L-E](#) [IS31AP2036A-CLS2-TR](#) [MAX9723DEBE+T](#) [TDA7563ASMTR](#) [AS3561-DWLT](#) [SSM2517CBZ-R7](#)
[MP1720DH-12-LF-P](#) [SABRE9601K](#) [THAT1646W16-U](#) [MAX98396EWB+](#) [PAM8965ZLA40-13](#) [BD37532FV-E2](#) [BD5638NUX-TR](#)
[BD37512FS-E2](#) [BD37543FS-E2](#) [BD3814FV-E2](#) [TPA3140D2PWPR](#) [TS2007EIJT](#) [IS31AP2005-DLS2-TR](#) [SSM2518CPZ-R7](#) [AS3410-EQFP-](#)
[500](#) [FDA4100LV](#) [MAX98306ETD+T](#) [TS4994EIJT](#) [NCP2820FCT1G](#) [NCP2823AFCT2G](#) [NCS2211MNTXG](#) [CPA2233CQ16-A1](#)
[OPA1604AIPWR](#)