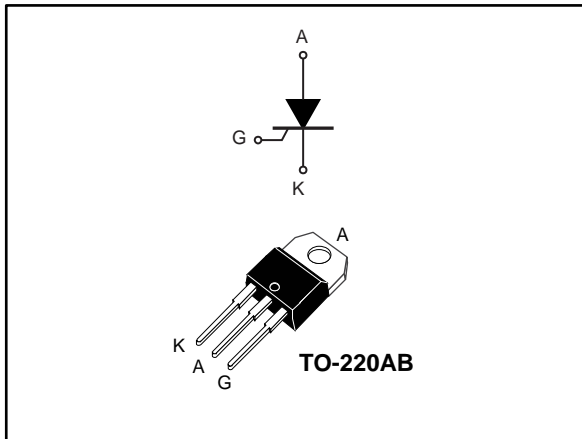

High temperature 20 A SCRs

Datasheet - production data

Description

Packaged in a non-isolated TO-220AB, this device offers high thermal performance during operation of up to 20 A_{RMS}, thanks to a junction temperature of up to 150 °C.

The combination of noise immunity and low gate triggering current allows to design strong and compact control circuit.

Table 1: Device summary

Order code	Package	V _{DRM} /V _{RRM}	I _{GT}
TN2010H-6T	TO-220AB	600 V	10 mA

Features

- High junction temperature: T_j = 150 °C
- High noise immunity dV/dt = 400 V/μs up to 150 °C
- Gate triggering current I_{GT} = 10 mA
- Peak off-state voltage V_{DRM}/V_{RRM} = 600 V
- High turn on current rise dI/dt = 100 A/μs
- ECOPACK®2 compliant component

Applications

- Motorbike voltage regulator circuits
- Inrush current limiting circuits
- Motor control circuits and starters
- Light dimmers
- Solid state relays

1 Characteristics

Table 2: Absolute maximum ratings (limiting values), $T_j = 25\text{ °C}$ unless otherwise specified

Symbol	Parameter		Value	Unit
$I_{T(RMS)}$	RMS on-state current (180 ° conduction angle)	$T_c = 132\text{ °C}$	20	A
$I_{T(AV)}$	Average on-state current (180 ° conduction angle)	$T_c = 132\text{ °C}$	12.7	A
		$T_c = 137\text{ °C}$	10	
		$T_c = 140\text{ °C}$	8	
I_{TSM}	Non repetitive surge peak on-state current (T_j initial = 25 °C)	$t_p = 8.3\text{ ms}$	197	A
		$t_p = 10\text{ ms}$	180	
I^2t	I^2t value for fusing	$t_p = 10\text{ ms}$	162	A^2s
di/dt	Critical rate of rise of on-state current $I_G = 2 \times I_{GT}$, $t_r \leq 100\text{ ns}$	$f = 60\text{ Hz}$	100	$A/\mu s$
V_{DSM}/V_{RSM}	Non repetitive surge peak off-state voltage	$t_p = 10\text{ ms}$	700	V
I_{GM}	Peak gate current	$t_p = 20\text{ }\mu s$	$T_j = 150\text{ °C}$	A
$P_{G(AV)}$	Average gate power dissipation	$T_j = 150\text{ °C}$	1	W
V_{RGM}	Maximum peak reverse gate voltage		5	V
T_{stg}	Storage junction temperature range		-40 to +150	°C
T_j	Operating junction temperature range		-40 to +150	°C
T_L	Maximum lead temperature for soldering during 10 s		260	°C

Table 3: Electrical characteristics ($T_j = 25\text{ °C}$ unless otherwise specified)

Symbol	Test conditions		Value	Unit	
I_{GT}	$V_D = 12\text{ V}$, $R_L = 33\text{ }\Omega$	Typ.	5	mA	
		Max.	10		
V_{GT}		Max.	1.3	V	
V_{GD}	$V_D = V_{DRM}$, $R_L = 3.3\text{ k}\Omega$	$T_j = 150\text{ °C}$	Min.	0.1	V
I_H	$I_T = 500\text{ mA}$, gate open		Max.	40	mA
I_L	$I_G = 1.2 \times I_{GT}$		Max.	60	mA
dV/dt	$V_D = 402\text{ V}$, gate open	$T_j = 150\text{ °C}$	Min.	400	$V/\mu s$
t_{gt}	$I_{TM} = 40\text{ A}$, $V_D = 402\text{ V}$, $I_G = 20\text{ mA}$, $(di/dt)_{max} = 0.2\text{ A}/\mu s$		Typ.	1.9	μs
t_q	$I_{TM} = 40\text{ A}$, $V_D = 402\text{ V}$, $(di/dt)_{off} = 30\text{ A}/\mu s$, $V_R = 25\text{ V}$, $dV_D/dt = 40\text{ V}/\mu s$	$T_j = 150\text{ °C}$	Typ.	70	μs

Table 4: Static characteristics

Symbol	Test conditions			Value	Unit
V_{TM}	$I_{TM} = 40 \text{ A}$, $t_p = 380 \mu\text{s}$	$T_j = 25 \text{ }^\circ\text{C}$	Max.	1.6	V
V_{TO}	Threshold voltage	$T_j = 150 \text{ }^\circ\text{C}$	Max.	0.82	
R_D	Dynamic resistance	$T_j = 150 \text{ }^\circ\text{C}$	Max.	17.5	m Ω
I_{DRM} , I_{RRM}	$V_D = V_{DRM}$, $V_R = V_{RRM}$	$T_j = 25 \text{ }^\circ\text{C}$	Max.	5	μA
		$T_j = 125 \text{ }^\circ\text{C}$		2	mA
		$T_j = 150 \text{ }^\circ\text{C}$		3.9	

Table 5: Thermal parameters

Symbol	Parameter		Value	Unit
$R_{th(j-c)}$	Junction to case (DC)	Max.	1.0	$^\circ\text{C/W}$
$R_{th(j-a)}$	Junction to ambient (DC)	Typ.	60	

1.1 Characteristics (curves)

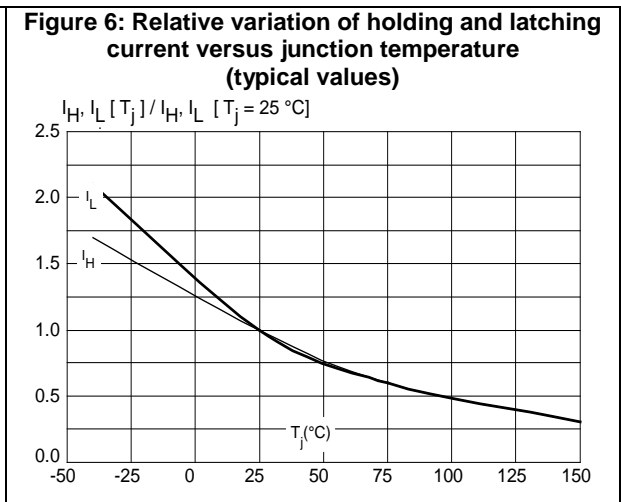
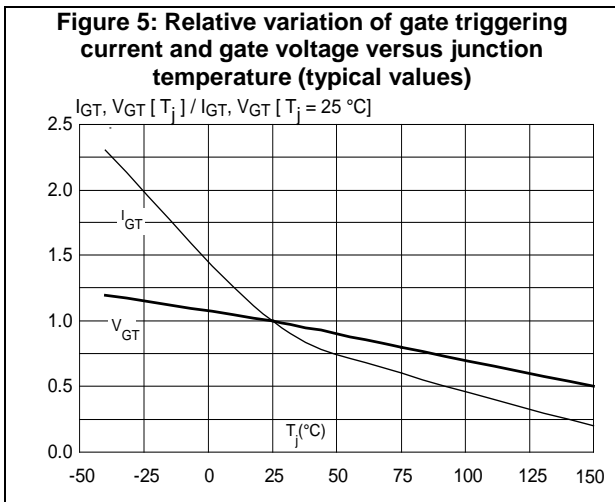
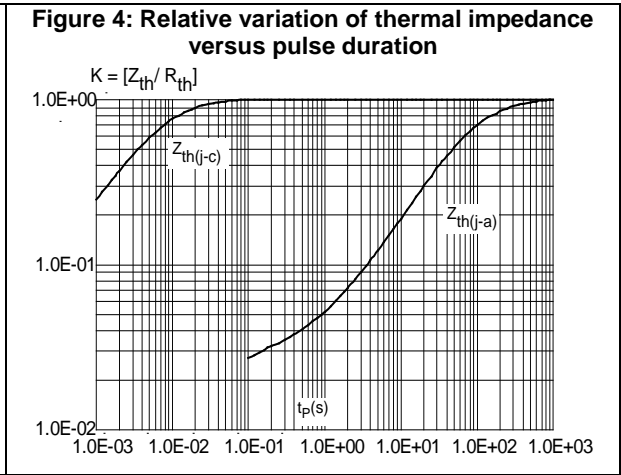
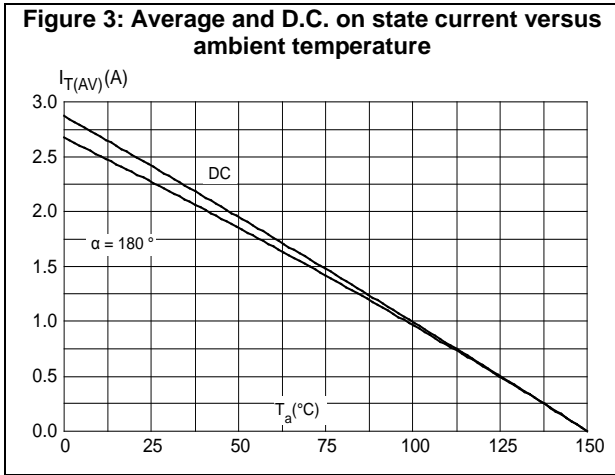
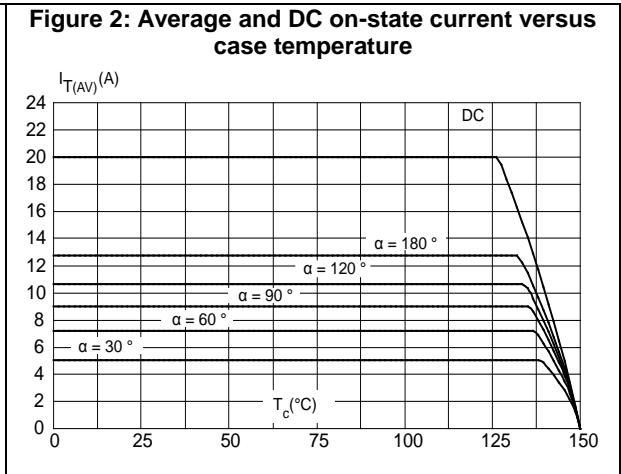
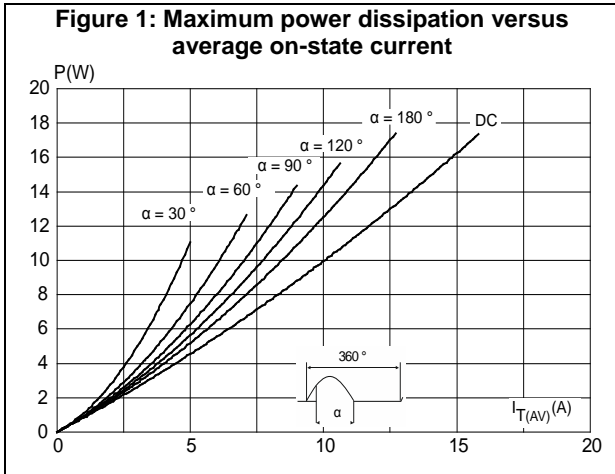

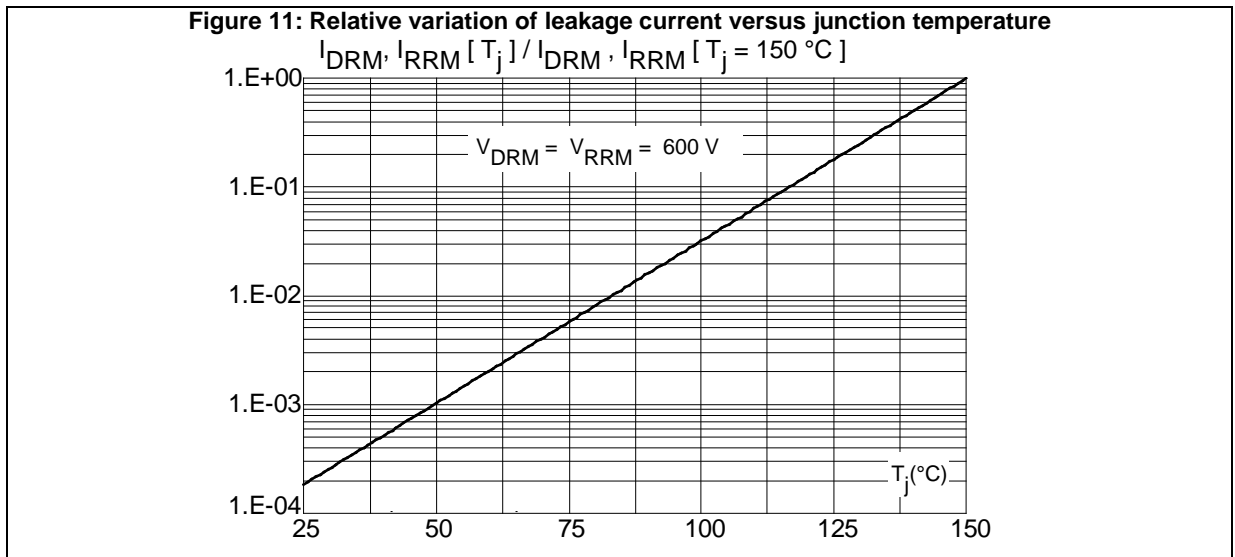
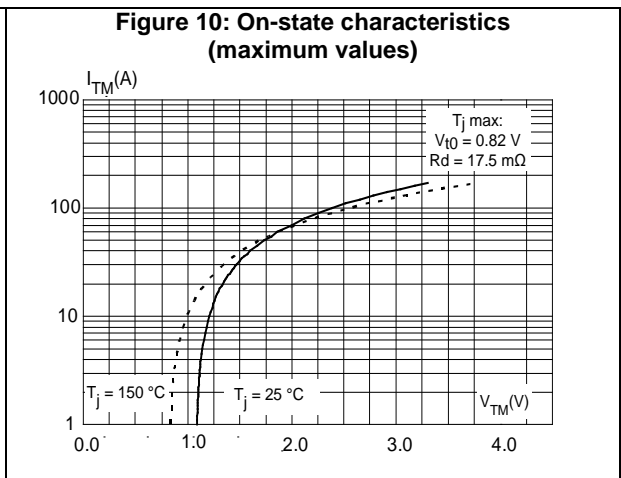
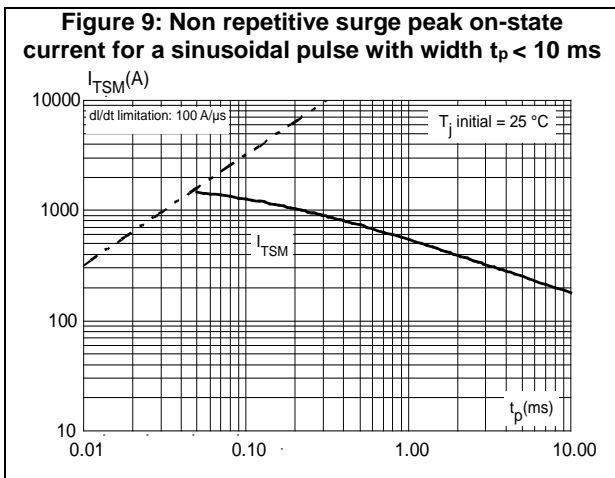
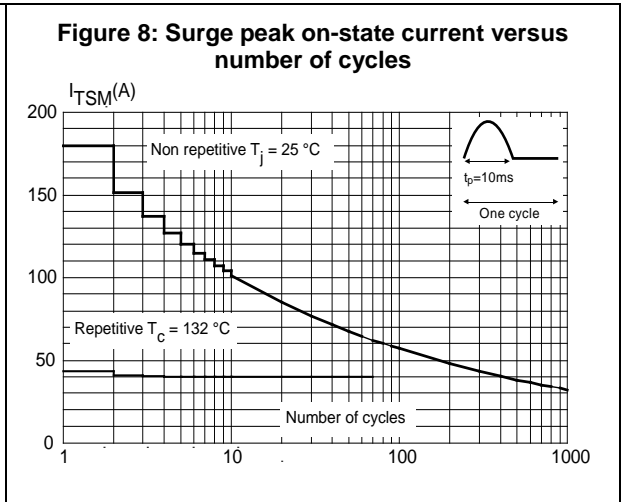
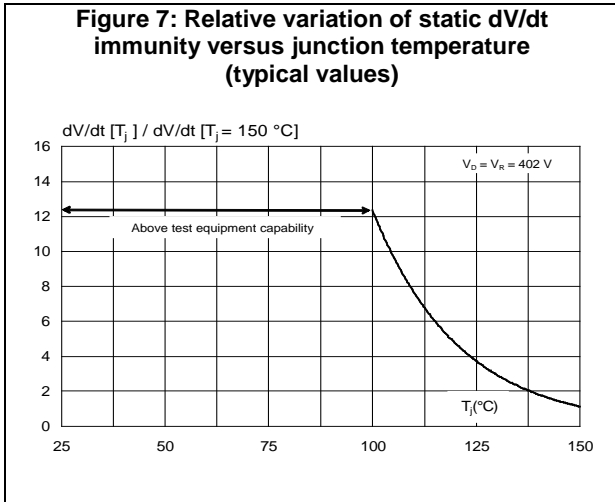

2 Package information

In order to meet environmental requirements, ST offers these devices in different grades of ECOPACK® packages, depending on their level of environmental compliance. ECOPACK® specifications, grade definitions and product status are available at: www.st.com. ECOPACK® is an ST trademark.

- Epoxy meets UL94, V0
- Lead-free, halogen-free package
- Recommended torque value (TO-220AB): 0.4 to 0.6 N.m

2.1 TO-220AB package information

Figure 12: TO-220AB (NIns.) package outline

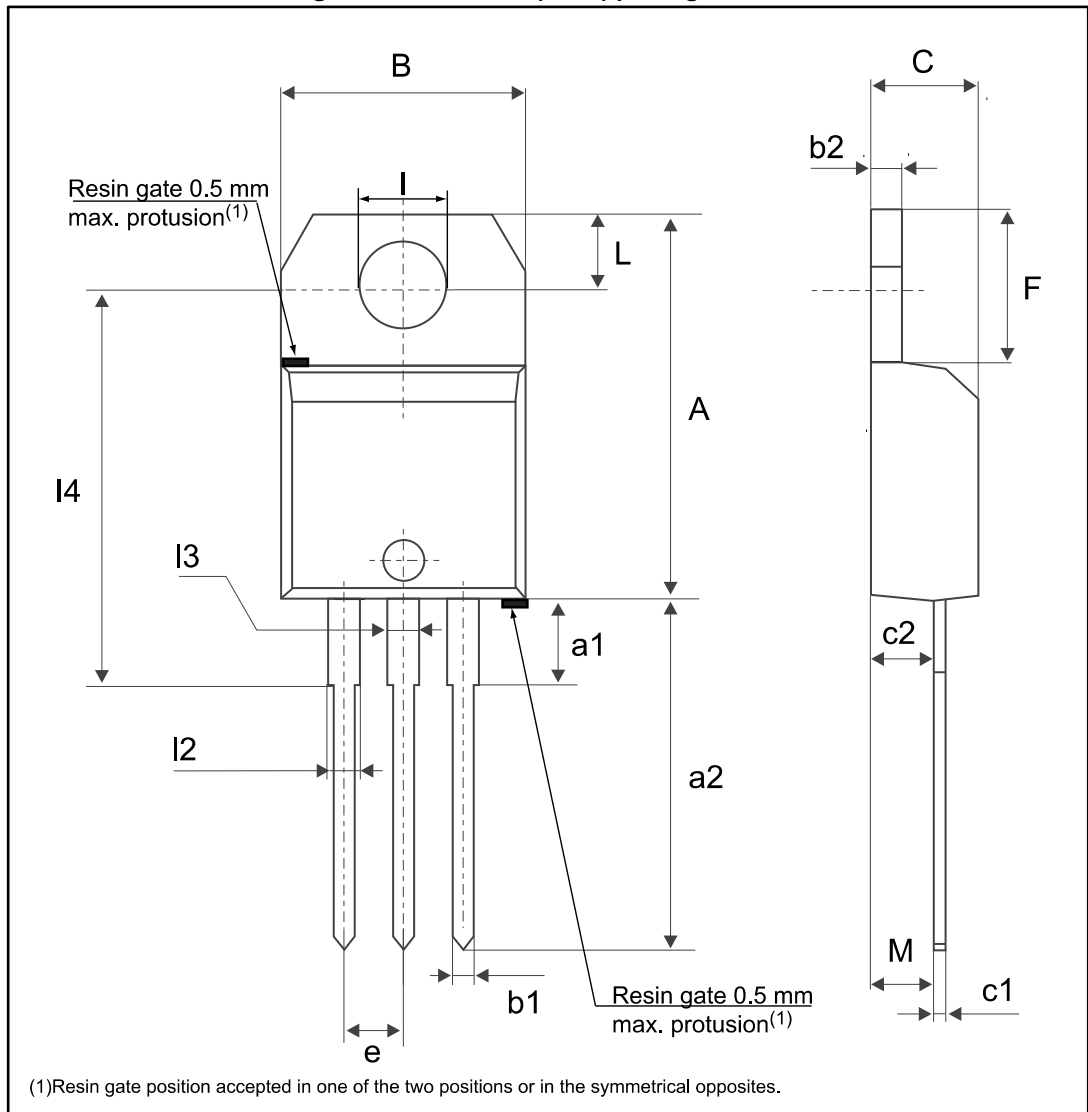

Table 6: TO-220AB (NIns.) package mechanical data

Ref.	Dimensions					
	Millimeters			Inches ⁽¹⁾		
	Min.	Typ.	Max.	Min.	Typ.	Max.
A	15.20		15.90	0.5984		0.6260
a1		3.75			0.1476	
a2	13.00		14.00	0.5118		0.5512
B	10.00		10.40	0.3937		0.4094
b1	0.61		0.88	0.0240		0.0346
b2	1.23		1.32	0.0484		0.0520
C	4.40		4.60	0.1732		0.1811
c1	0.49		0.70	0.0193		0.0276
c2	2.40		2.72	0.0945		0.1071
e	2.40		2.70	0.0945		0.1063
F	6.20		6.60	0.2441		0.2598
I	3.73		3.88	0.1469		0.1528
L	2.65		2.95	0.1043		0.1161
I2	1.14		1.70	0.0449		0.0669
I3	1.14		1.70	0.0449		0.0669
I4	15.80	16.40	16.80	0.6220	0.6457	0.6614
M		2.6			0.1024	

Notes:

⁽¹⁾Inch dimensions are for reference only.

3 Ordering information

Figure 13: Ordering information scheme

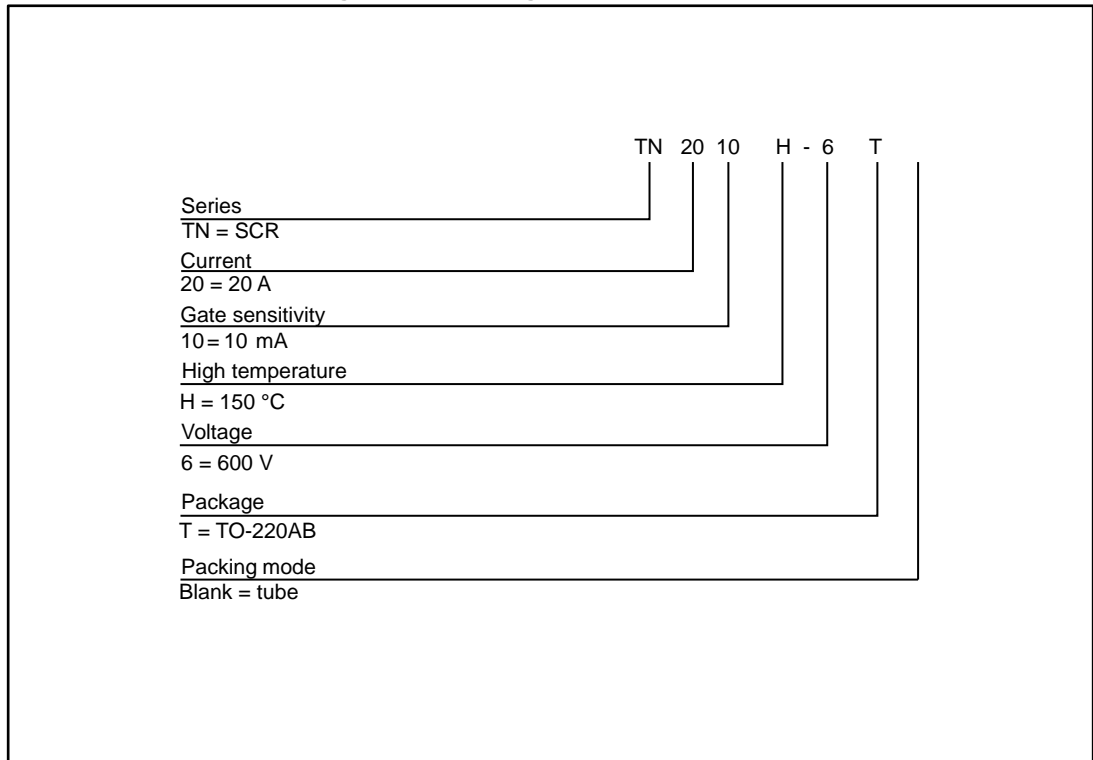

Table 7: Ordering information

Order code	Marking	Package	Weight	Base qty.	Delivery mode
TN2010H-6T	TN2010H6	TO-220AB	2.3 g	50	Tube

4 Revision history

Table 8: Document revision history

Date	Revision	Changes
29-Aug-2017	1	Initial release.

IMPORTANT NOTICE – PLEASE READ CAREFULLY

STMicroelectronics NV and its subsidiaries ("ST") reserve the right to make changes, corrections, enhancements, modifications, and improvements to ST products and/or to this document at any time without notice. Purchasers should obtain the latest relevant information on ST products before placing orders. ST products are sold pursuant to ST's terms and conditions of sale in place at the time of order acknowledgement.

Purchasers are solely responsible for the choice, selection, and use of ST products and ST assumes no liability for application assistance or the design of Purchasers' products.

No license, express or implied, to any intellectual property right is granted by ST herein.

Resale of ST products with provisions different from the information set forth herein shall void any warranty granted by ST for such product.

ST and the ST logo are trademarks of ST. All other product or service names are the property of their respective owners.

Information in this document supersedes and replaces information previously supplied in any prior versions of this document.

© 2017 STMicroelectronics – All rights reserved

X-ON Electronics

Largest Supplier of Electrical and Electronic Components

Click to view similar products for [SCRs](#) category:

Click to view products by [STMicroelectronics](#) manufacturer:

Other Similar products are found below :

[NTE5428](#) [T1500N16TOF VT](#) [T880N16TOF](#) [TT162N16KOF-A](#) [TT162N16KOF-K](#) [TT330N16AOF](#) [VS-22RIA20](#) [VS-2N685](#) [057219R](#)
[T1190N16TOF VT](#) [T1220N22TOF VT](#) [T201N70TOH](#) [T700N22TOF](#) [T830N18TOF](#) [TT250N12KOF-K](#) [VS-110RKI40](#) [NTE5427](#) [NTE5442](#)
[T2160N28TOF VT](#) [TT251N16KOF-K](#) [VS-22RIA100](#) [VS-16RIA40](#) [TD250N16KOF-A](#) [VS-ST110S16P0](#) [T930N36TOF VT](#) [T2160N24TOF](#)
[VT](#) [T1190N18TOF VT](#) [T1590N28TOF VT](#) [2N1776A](#) [T590N14TOF](#) [NTE5375](#) [NTE5460](#) [NTE5481](#) [NTE5512](#) [NTE5514](#) [NTE5518](#)
[NTE5519](#) [NTE5529](#) [NTE5553](#) [NTE5555](#) [NTE5557](#) [NTE5567](#) [NTE5570](#) [NTE5572](#) [NTE5574](#) [NTE5576](#) [NTE5578](#) [NTE5579](#) [NTE5589](#)
[NTE5592](#)